



CATALOGUE  
**POWER FACTOR  
CORRECTION LV**

new



## New MIDImatic. NOW ALSO AVAILABLE DETUNED.

The MIDImatic PFCS adds new electrical performances and mechanical features.

New electrical performances:

- FH20 detuned range
- 10 kvar smaller steps for FH20 series and 15kvar smaller steps for HP10
- New optionals: MCCB or fused load break switch as main incomer, in place of load break switch.

New mechanical features:

- IP3X metallic enclosure made of galvanized steel uprights and removable panels
- Assembled with MULTrack trays: better robustness and availability for spare parts
- Extra room for power cable easier connection.



## Electronic Fast Switches

Static compensation is very often the only way to afford networks with relatively high fluctuating loads (milliseconds).

The main advantages of this compensation system are:

- An immediate answer to the compensation request
- No electromagnetic contactors: the total absence of mobile mechanic parts increase the number of switching operations and reduce the maintenance
- The lack of transients in the capacitor switching connections minimizes disturbance such as flicker, noise, voltage drop.



## MULTImatic IP4X

The degree of protection IP4X is no longer an option for MULTImatic PFCS but it becomes a STANDARD feature, for better system reliability and durability.

Furthermore, the new cabinet simplifies the maintenance operations, thanks to the easily removable panels.



## Enerscope-3S: Power Quality and Energy Analyzer

The ideal tool for both Power Quality troubleshooting and discovering Energy Savings.

Enerscope-3S will give you the data you need to quickly get to the heart of the problem and figure out the right solution!



## EXTEND FOR FREE THE WARRANTY OF YOUR ICAR PFC SYSTEM FOR ADDITIONAL 12 MONTHS

Applied to all Automatic Power Factor Correction Systems (MICROmatic, MINImatic, MIDImatic, MULTImatic) of the following ranges:

- FH: Power Factor Correction Systems with high energy density polypropylene capacitors and detuned reactors
- FD: Power Factor Correction Systems with metallized paper capacitors and detuned reactors
- TC: Power Factor Correction Systems with metallized paper capacitors.

Fill out the form on the web site [www.warranty.icar.com](http://www.warranty.icar.com) within 60 days from the delivery date to have the right to extension.



# ICAR: products and solutions

Founded in 1946, ICAR is a leading manufacturer of capacitors and power factor correction systems in low and medium voltage; it controls with its own companies all production phases: the polypropylene/paper film, metallization, winding, manufacturing of the finished product.

The entire process is checked in order to obtain a product of high quality level that guarantees its functioning even in the most burdensome plant configurations.

The ICAR Group has 6 plants, all located in Europe.

For details on the individual families, download the full catalogs on the website, [www.icar.com](http://www.icar.com). Here are all equipment and the solutions ICAR proposes.



Bank for power factor correction



Capacitors and MT power factor correction systems

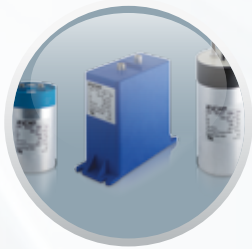

Power electronics capacitors



Active filters



LV voltage stabilizers



EMI RFI filters



Motor run capacitors



Capacitors for energy storage and rapid discharge



Lighting capacitors



Reactors and LV/LV special transformers

# Services

For many companies, the electricity is an important cost element, and a part of the amounts is due to the consumption of reactive energy. All companies that distribute electricity are collecting penalties in the bill of consumption, if the user consumes reactive power over the allowed limits.

So today is particularly convenient to install a power factor correction system effectively, correctly sized, which saves a lot of money: a power factor corrector is often pay for itself within a year.

But we must not forget the power factor correction installed for several years: we must monitor the proper functioning because if you do not keep them in perfect working order, they "lose power", and you are likely to pay penalties. With proper maintenance you can avoid wasting money and unnecessary power dissipation in the electric plant cables and transformers that undergoes premature aging.

It is also important a proper maintenance and use of original spare parts since capacitors, when worn or of poor quality, are likely to burst causing damage to electrical equipment, plant shutdowns due to protection tripping, or even real fire.

## Our services:

- Interventions to verify existing power factor correction systems
- Interventions on electrical systems analysis and LV verification to be corrected
- Interventions on the start-up and commissioning of new LV power factor correction banks
- Analysis on the energy quality in LV installations
- Scheduled maintenance on power factor correction systems
- Revamping solutions
- Original spare parts
- Analysis of the Energy Authority Penalties.



Commissioning



Make your own measurement and let us know



Check-up of existing PFC systems



Local support



Tailor made capacitor banks



Power Quality Assessment



Technical training



Revamping solutions, original spare parts

# Quality

ICAR has always regarded product quality and effectiveness of internal processes as key factors of corporate strategy. In ICAR we believe that compliance with international standards is a basic requirement to offer equipment that can meet the needs of our customers.

## Quality System

The ICAR Quality management system is certified according to ISO 9001 since 1994.

We participate actively in international standards committees that draft regulations applicable to our production equipment, and in particular to industrial capacitors: this guarantees to be always up with changes in legislation, or rather pre-empt it.

Since 2011 the ICAR quality management system is certified by IRIS (International Railway Industry Standard). Promoted by UNIFE (Association of European companies operating in the railway sector) and supported by operators, system integrators and equipment manufacturers, IRIS integrates the ISO 9001 quality standard introducing additional requirements, specific to the railway industry.



Certificato UNI EN  
Iso9001:2008

IRIS is modeled on quality standards similar to those already in use in the automotive and aerospace industries.

Independent certification bodies and approved by the promulgators of the standard ensure objectivity and transparency in the evaluation.



IRIS certification, while being oriented in the rail sector, has a positive effect on the whole ICAR quality system, with benefits for all types of produced devices.

The valid certificates can be downloaded from the website [www.icar.com](http://www.icar.com) the section "Company - Quality"

## Product quality

The equipment produced in ICAR are tested both in our laboratories and in the most important internationally recognized laboratories, in order to ensure compliance with the highest standards.

# The convenience of power factor correction



The Electricity Authorities, force companies distributing electricity to apply financial penalties to utilities that have a substantial contractual power and energy

cos phi with a lower average of 0,9.

The correct power factor of the electric plant allows you to avoid those penalties, which often are not reflected in the bill, and then are paid by the final user without even realizing it.

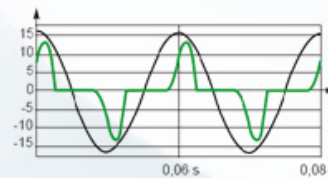

The industrial electric plants are increasingly affected by harmonic currents caused by inverters, electronic drives, computers, filament free lamps, motors with variable speed drives, etc.

The harmonics cause more stress to the power factor correction capacitors: their performance decade by dropping progressively cos phi of the system to below the fateful value of 0,9. You may pay significant penalties... as time goes on!



In an electric industrial plant, the installation of a photovoltaic in on-site exchange causes reduction of the power factor seen to the counter.

After connection of the photovoltaic electricity, bills may be burdened with significant penalties.

The ICAR equipment have many steps, for better adjustment of the cos phi: up to 19 combinations!

The high number of steps also allows less stress on mechanical and electrical parts: it avoids the hunting phenomenon, typical of the equipment with a few steps. A capacitor with a lot of steps is also able to fully adjust the cos phi also with low load or with large fluctuations in the demand for reactive energy (as happens for example in solar power plants in exchange).

The new electronic controllers are able to guarantee the cos phi set respect, even in the limit operation conditions of the plant. Moreover, thanks to the advanced diagnostic capabilities, they make possible to monitor weekly the power factor and many other indicators (data, alarms), even remotely, for better management and maintenance.

# Glossary

**Cos Phi.** Simplifying, in an electrical system is appointed with phi ( $\phi$ ), the phase shift between the voltage and the electric current at the fundamental frequency of the system (50Hz). The cos phi is therefore a dimensionless number between 0 and 1, and varies from moment to moment. Typically, an industrial electrical system has an inductive cos phi, which value depends on the characteristics of the user plant.

**Power factor.** In an electrical system means, with power factor, the ratio between the active power and the apparent power. Also the power factor is a dimensionless quantity between 0 and 1, which varies from moment to moment. However, the cos phi and the power factor coincide only in systems devoid of sinusoidal harmonic currents. In a system with harmonic, the power factor is always less than the cos phi.

## Monthly average power factor.

Electricity bills often show the monthly average power factor, obtained from the ratio between the active power consumed by the user and the apparent power transited the point of delivery. Typically, the average monthly power factor is calculated separately on different time slots.

## Penalty for low power factor.

If the monthly average power factor is less than 0,9 lagging, are applied in the bill some financial penalties.

**Isolation level.** For a capacitor that complies with IEC 61921, the isolation level is indicative of the voltage pulse that can withstand.

**Insulation voltage.** For a power factor correction system that complies with the IEC 60439-1/2, the isolation voltage is indicative of the maximum voltage that can withstand the entire system.

## Nominal voltage of the capacitor $U_N$ .

It is the rated voltage of the capacitor, at which its output rated power is calculated.

## Maximum operating voltage $U_{MAX}$ .

It is the maximum voltage that the capacitor can withstand, for the time indicated by the IEC 60831-1/2. The following relation applies  $U_{MAX} = 1,2 U_N$ .

## Rated operational voltage $U_e$ .

It is the rated voltage of the power factor correction system, which guarantees proper use. A capacitor with a rated voltage can have on board capacitors with voltage  $U_N > U_e$ . It may never happen otherwise.

## Short-circuit current $I_{cc}$ .

As indicated in the IEC 61439-1 Article 3.8.9.4, is the prospective short-circuit current that the cabinet can endure for a specified time. It's a value stated by the manufacturer of the cabinet on the basis of laboratory tests. The short-circuit current of the cabinet can be increased, in case of need, by installing fuses. In this case the declared data must be accompanied by the words "fuse conditioning short-circuit current."

## Steps aboard an automatic power factor corrector.

They are the physical units of power factor bank, each controlled by a dedicated switching device (static switch or contactor). A rack may be constituted by a single step (as typically occurs in detuned bank) or more steps. For example, the MULTrack HP10 from 150kvar/400V consists of 6 steps: 2 from 15kvar and 4 from 30kvar. It is easily verified by counting the number of contactors present on the front of the drawer. More step can be merged to achieve larger power steps: in these cases they are controlled by the same controller contact.

**Combinations.** It is the internal configurations number which proposes a particular automatic power factor corrector, as a function of the steps (number and power) that has on board. For example, a power factor corrector of 280kvar with steps 40-80-160 offers 7 combinations: 40-80-120-160-200-240-280.

The greater the number of possible combinations, the better "accuracy" and the flexibility to use the power factor correction bank.

## THD (Total Harmonic Distortion).

For a periodic non-sinusoidal wave, the THD is the ratio between the rms of all harmonic components value and the rms value of the fundamental at 50Hz.

**THDI<sub>C</sub>.** It is the maximum THD that a capacitor can withstand, with regard to the current passing through it. It is a characteristic value of each capacitor, indicative of its robustness: much higher is the THDI<sub>C</sub>, more robust is the capacitor. The THDI<sub>C</sub> is the most significant value to compare different capacitors, together with the maximum temperature of use.

**THDI<sub>R</sub>.** It is the maximum THD bearable by the capacitor relatively to the current that circulates in the plant to be corrected. It is an empirical fact, which is based on THDI<sub>C</sub> and experience of the manufacturer. There is no theoretical link between THDI<sub>R</sub> and THDI<sub>C</sub> valid for all plants. The THDI<sub>R</sub> can also be very different for capacitors with the same THDI<sub>C</sub> as made by different manufacturers.

**THDV.** It is the voltage THD bearable by a power factor correction bank with harmonic blocking reactors.

**$f_N$ :** is the detuning frequency between inductance and capacitance of a detuned capacitor bank, that is a capacitor bank equipped with harmonic blocking reactors. The detuning frequency is the most objective parameter for detuned capacitor bank comparison; the lower the detuning frequency is the sounder the capacitor bank is.

In particular an 180Hz detuned capacitor bank is sounder and more reliable than another with 189Hz detuning frequency  $f_N$ .

As of Ferranti effect, detuned capacitor bank capacitors are exposed to a voltage that is higher than the rated system voltage; for this reason these capacitors are rated for higher voltage according to the p% factor.

# Summary

CHAPTER 1	Power factor correction principles	1
CHAPTER 2	Selection criteria depending on the type of plant	8
CHAPTER 3	Power factor correction. Solutions with standard or high gradient metallized polypropylene capacitors	19
CHAPTER 4	Power factor correction. Solutions with metallized paper capacitors	33
CHAPTER 5	Passive and active harmonic filters	41
CHAPTER 6	Reactive power controllers and protections	42
CHAPTER 7	Dimensions	49
APPENDIX		73



# Power Factor Correction Principles

## Power factor correction: why?

In electrical circuits the current is in phase with the voltage whenever are in presence of resistors, whereas the current is lagging if the load is inductive (motors, transformers with no load conditions), and leading if the load is capacitive (capacitors).

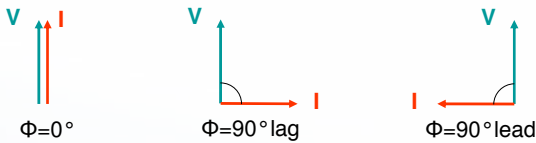

The total absorbed current, for example, by a motor is determined by vector addition of:

1.  $I_R$  resistive current;
2.  $I_L$  inductive reactive current;



These currents are related to the following powers:

1. active power linked to  $I_R$ ;
2. reactive power linked to  $I_L$ ;

The reactive power doesn't produce mechanical work and it is an additional load for the energy supplier. The parameter that defines the consumption of reactive power is the power factor.

We define power factor the ratio between active power and apparent power:

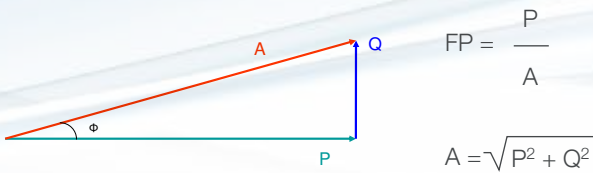

As far as there are not harmonic currents power factor coincides to  $\cos\phi$  of the angle between current and voltage vectors.  $\cos\phi$  decreases as the reactive absorbed power increases.

Low  $\cos\phi$ , has the following disadvantages:

1. High power losses in the electrical lines
2. High voltage drop in the electrical lines
3. Over sizing of generators, electric lines and transformers.

From this we understand the importance to improve (increase) the power factor. Capacitors need to obtain this result.

## Power factor correction: how?

By installing a capacitor bank it is possible to reduce the reactive power absorbed by the inductive loads in the system and consequently to improve power factor.

It is suitable to have  $\cos\phi$  a little in excess of 0.9 to avoid paying the penalties provided for by the law.  $\cos\phi$  must not be too close to unity, to avoid the leading currents in of the electrical system.

The choice of the correct power factor correction equipment depends on the type of loads present and by their way of working.

The choice is between CENTRAL COMPENSATION and INDIVIDUAL COMPENSATION.

Individual compensation: power factor correction is wired at each single load (i.e. motor terminals)

Central compensation: there is only one bank of capacitors on the main power distribution switch board or substation.

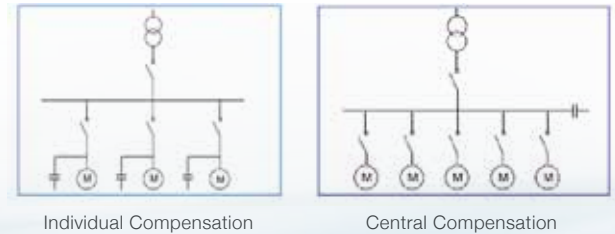

The individual compensation is a simple technical solution: the capacitor and the user equipment follow the same sorts during the daily work, so the regulation of the  $\cos\phi$  becomes systematic and closely linked to the load.

Another great advantage of this type of power factor correction is the simple installation with low costs.

The daily trend of the loads has a fundamental importance for the choice of most suitable power factor correction.

In many systems, not all the loads work in the same time and some of them work only a few hours per day.

It is clear that the solution of the individual compensation becomes too expensive for the high number of capacitors that have to be installed. Most of these capacitors will not be used for long period of time.

The individual compensation is more effective if the majority of the reactive power is concentrated on a few substations loads that work long period of time.

Central compensation is best suited for systems where the load fluctuates throughout the day.

If the absorption of reactive power is very variable, it is advisable the use of automatic regulation in preference to fixed capacitors.

## Power factor correction: How many capacitors?

The choice of capacitor bank to install in a system is closely depended from:

- $\cos\phi_2$  value that we would obtain
- $\cos\phi_1$  starting value
- installed active power.

By the following equation:

$$Q_c = P * (\tan\phi_1 - \tan\phi_2)$$

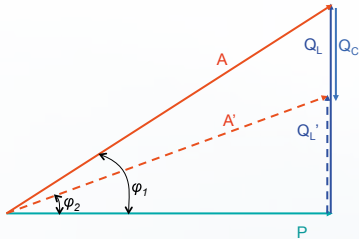

$Q_c$  = Required Capacitors Reactive Output [kvar];

$P$  = Active Power [kW];

$Q_L, Q'_L$  = Inductive Reactive Output before and after the installation of the capacitor bank;

$A, A'$  = apparent power before and after the power factor correction [kVA].

As example if we have installed a load that absorbs an active power of 300 kW having a power factor 0.7 and we want to increase it until 0.92.

From the table 1 we find:  $k = 0,692$

Which means:  $Q_c = 0,692 * 300 = 207,6$  kvar

Can be also written  $Q_c = k * P$

Starting power factor	Final power factor					
	0,9	0,91	0,92	0,93	0,94	0,95
0,40	1,807	1,836	1,865	1,896	1,928	1,963
0,41	1,740	1,769	1,799	1,829	1,862	1,896
0,42	1,676	1,705	1,735	1,766	1,798	1,832
0,43	1,615	1,644	1,674	1,704	1,737	1,771
0,44	1,557	1,585	1,615	1,646	1,678	1,712
0,45	1,500	1,529	1,559	1,589	1,622	1,656
0,46	1,446	1,475	1,504	1,535	1,567	1,602
0,47	1,394	1,422	1,452	1,483	1,515	1,549
0,48	1,343	1,372	1,402	1,432	1,465	1,499
0,49	1,295	1,323	1,353	1,384	1,416	1,450
0,50	1,248	1,276	1,306	1,337	1,369	1,403
0,51	1,202	1,231	1,261	1,291	1,324	1,358
0,52	1,158	1,187	1,217	1,247	1,280	1,314
0,53	1,116	1,144	1,174	1,205	1,237	1,271
0,54	1,074	1,103	1,133	1,163	1,196	1,230
0,55	1,034	1,063	1,092	1,123	1,156	1,190
0,56	0,995	1,024	1,053	1,084	1,116	1,151
0,57	0,957	0,986	1,015	1,046	1,079	1,113
0,58	0,920	0,949	0,979	1,009	1,042	1,076
0,59	0,884	0,913	0,942	0,973	1,006	1,040
0,60	0,849	0,878	0,907	0,938	0,970	1,005
0,61	0,815	0,843	0,873	0,904	0,936	0,970
0,62	0,781	0,810	0,839	0,870	0,903	0,937
0,63	0,748	0,777	0,807	0,837	0,870	0,904
0,64	0,716	0,745	0,775	0,805	0,838	0,872
0,65	0,685	0,714	0,743	0,774	0,806	0,840
0,66	0,654	0,683	0,712	0,743	0,775	0,810
0,67	0,624	0,652	0,682	0,713	0,745	0,779
0,68	0,594	0,623	0,652	0,683	0,715	0,750
0,69	0,565	0,593	0,623	0,654	0,686	0,720
0,70	0,536	0,565	0,594	0,625	0,657	0,692
0,71	0,508	0,536	0,566	0,597	0,629	0,663
0,72	0,480	0,508	0,538	0,569	0,601	0,635
0,73	0,452	0,481	0,510	0,541	0,573	0,608
0,74	0,425	0,453	0,483	0,514	0,546	0,580
0,75	0,398	0,426	0,456	0,487	0,519	0,553
0,76	0,371	0,400	0,429	0,460	0,492	0,526
0,77	0,344	0,373	0,403	0,433	0,466	0,500
0,78	0,318	0,347	0,376	0,407	0,439	0,474
0,79	0,292	0,320	0,350	0,381	0,413	0,447
0,80	0,266	0,294	0,324	0,355	0,387	0,421
0,81	0,240	0,268	0,298	0,329	0,361	0,395
0,82	0,214	0,242	0,272	0,303	0,335	0,369
0,83	0,188	0,216	0,246	0,277	0,309	0,343
0,84	0,162	0,190	0,220	0,251	0,283	0,317
0,85	0,135	0,164	0,194	0,225	0,257	0,291
0,86	0,109	0,138	0,167	0,198	0,230	0,265
0,87	0,082	0,111	0,141	0,172	0,204	0,238

Table 1  
See the full table in Appendix

A typical example of power factor correction, sometimes not much considered but surely important, concerns the power factor correction of transformers for the distribution of energy. It is essentially a fixed power factor correction that must compensate for the reactive power absorbed by the transformer in its no load condition (this happens often during the night). The calculation of the needed reactive output is very easy and it bases itself on this equation:

$$Q_c = I_0\% * \frac{A_N}{100}$$

where

$I_0\%$  = magnetising current of the transformer

$A_N$  = Apparent rated power in kVA of the transformer

If we don't have these parameters, it is convenient to use the following table.

Power transformer KVA	Oil transformer kvar	Resin transformer kvar
10	1	1,5
20	2	1,7
50	4	2
75	5	2,5
100	5	2,5
160	7	4
200	7,5	5
250	8	7,5
315	10	7,5
400	12,5	8
500	15	10
630	17,5	12,5
800	20	15
1000	25	17,5
1250	30	20
1600	35	22
2000	40	25
2500	50	35
3150	60	50

Table 2

Another very important example of power factor correction concerns asynchronous three-phase motors that are individually corrected. The reactive power likely needed is reported on table 3:

Motor power		Required Reactive Power (kvar)				
HP	kW	3000 rpm	1500 rpm	1000 rpm	750 rpm	500 rpm
0,4	0,55	-	-	0,5	0,5	-
1	0,73	0,5	0,5	0,6	0,6	-
2	1,47	0,8	0,8	1	1	-
3	2,21	1	1	1,2	1,6	-
5	3,68	1,6	1,6	2	2,5	-
7	5,15	2	2	2,5	3	-
10	7,36	3	3	4	4	5
15	11	4	5	5	6	6
30	22,1	10	10	10	12	15
50	36,8	15	20	20	25	25
100	73,6	25	30	30	30	40
150	110	30	40	40	50	60
200	147	40	50	50	60	70
250	184	50	60	60	70	80

Table 3

Be careful: the capacitor output must not be dimensioned too high for individual compensated machines where the capacitor is directly connected with the motor terminals. The capacitor placed in parallel may act as a generator for the motor which will cause serious overvoltages (self-excitation phenomena). In case of wound rotor motor the reactive power of the capacitor bank must be increased by 5%.

## Power factor correction: technical reasons

Recent energy market deregulation, along with new potential energy supplier rising, had lead to many and different type of invoicing which are not very clear in showing Power Factor up.

However as energy final price is steady growing, to correct power factor is becoming more and more convenient.

In most of the cases power factor improvement device prime cost is paid back in few months.

Technical-economical advantages of the installation of a capacitor bank are the following:

- decrease of the losses in the network and on the transformers caused by the lower absorbed current
- decrease of voltage drops on lines
- optimisation of the system sizing.

The current I, that flows in the system, is calculated by:

$$I = \frac{P}{\sqrt{3} * V * \cos\phi}$$

where

P= Active power

V= Nominal Voltage

While  $\cos\phi$  increases, with the same absorbed power we can obtain a reduction in the value of the current and as a consequence the losses in the network and on the transformers are reduced. Therefore we have an important saving on the size of electrical equipment used on a system. The best system sizing has some consequence on the line voltage drop. We can easily see that looking at the following formula:

$$\Delta V = R * \frac{P}{V} + X * \frac{Q}{V}$$

where

P= active power on the network (kW)

Q= reactive power on the network (kvar)

while R is the cable resistance and X its reactance ( $R \ll X$ ).

The capacitor bank installation reduces Q so we have a lower voltage drop. If, for a wrong calculation of the installed capacitor bank value, the reactive part of the above equation becomes negative, instead of a reduction of the voltage drop we have an increasing of the voltage at the end of the line (Ferranti Effect) with dangerous consequence for the installed loads.

Some examples clarify the concepts set out above:

1. Power loss (kW), in function of  $\cos\phi$ , from a copper cable 3 x 25mm<sup>2</sup> 100m long carrying 40kW at 400Vac
2. Supplied active power (kW) by a transformer 100kVA, in function of  $\cos\phi$ .

$\cos\phi$	1)	2)
0,5	3,2	50
0,6	2,3	60
0,7	1,6	70
0,8	1,3	80
0,9	1	90
1		100

As we can see as the power factor increases we have fewer losses in the network and more active power from the same KVA.

This allows us to optimise on the system sizing.

## Power factor correction: Harmonics in the network

The distortions of the voltage and current waveforms are generated by non-linear loads (inverter, saturated transformers, rectifier, etc.) and produce the following problems:

- On the A.C. motors we find mechanical vibration that can reduce expected life. The increase of the losses creates overheating with consequent damaging of the insulating materials
- In transformers they increase the copper and iron losses with possible damaging of the windings. The presence of direct voltage or current could cause the saturation of the cores with consequent increasing of the magnetising current
- The capacitors suffer from the overheating and the increasing of the voltage that reduce their life.

The waveform of the current (or voltage) generated by a non-linear load (fig. 1), being periodical, could be represented by the sum of many sinusoidal waves (a 50Hz component called fundamental and other components with multiple frequency of the fundamental component so called HARMONICS).

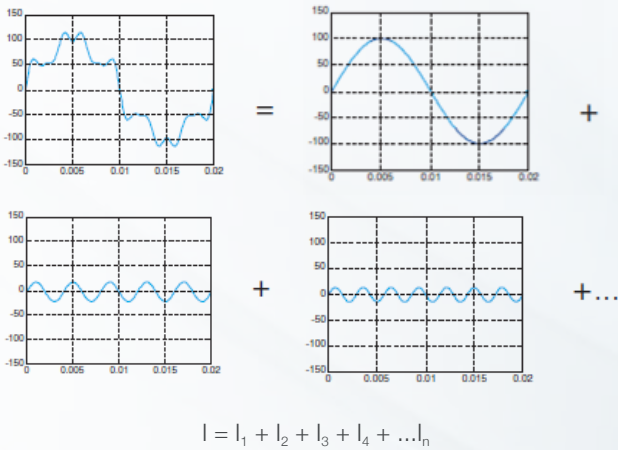

It is not advisable to install the power factor correction without considering the harmonic content of a system. This is because, even if we could manufacture capacitors that can withstand high overloads, capacitors produce an increase of harmonic content, with the negative effects just seen. We speak about resonance phenomena when an inductive reactance is equal to the capacitive one:

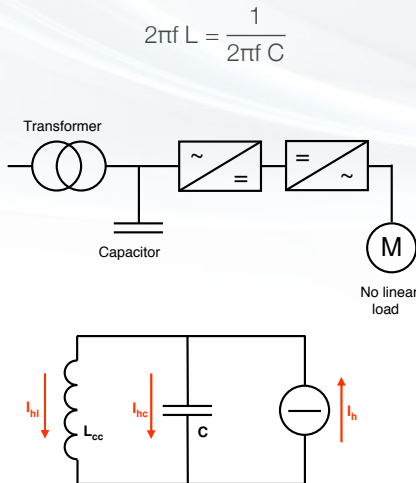

Ideal current generator represents motor as harmonic current components generator, these are independent from circuit inductance, while  $L_{CC}$  is obtainable by capacitor upstream short circuit power (in general it is equal to transformer short-circuit inductance) the resonance frequency is obtained as follows:

$$N = \sqrt{\frac{S_{cc}}{Q}} \cong \sqrt{\frac{A * 100}{Q * v_{cc}\%}}$$

$S_{cc}$  = Short-circuit power of the network (MVA)

$Q$  = Output of power factor correction bank (kvar)

$A$  = Rated power transformer (kVA)

$v_{cc}\%$  = Short-circuit voltage %

$N$  = Resonance harmonic order

In parallel resonance conditions the current and the voltage of the circuit  $L_{CC} - C$  are heavily amplified as well as the nearby harmonic currents. Hereinafter an example:

$A = 630\text{kVA}$  (rated power transformer)

$V_{cc}\% = 6$  (short-circuit voltage %)

$Q = 300\text{kvar}$  (output of power factor correction bank)

$$N = \sqrt{\frac{A * 100}{Q * v_{cc}\%}} = \sqrt{\frac{630 * 100}{300 * 6}} \cong 6$$

The result shows that in these conditions the system transformer-capacitor bank has the parallel resonance frequency of 300Hz ( $N \times 50\text{Hz}$ ). This means likely amplification of 5<sup>th</sup> and 7<sup>th</sup> harmonic current.

The most convenient solution to avoid this is the detuned filter, formed introducing a filter reactor in series with the capacitors, making this a more complex resonant circuit but with the desired feature of having a resonance frequency below the first existing harmonic.

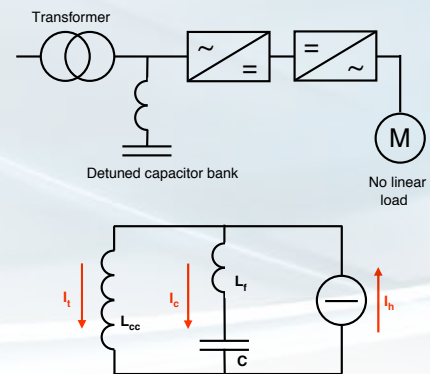

With this type of solution, the parallel resonance frequency is modified from

$$f_{rp} = \frac{1}{2 * \pi * \sqrt{L_{cc} * C}}$$

to

$$f_{rp} = \frac{1}{2 * \pi * \sqrt{(L_{cc} + L_t) * C}}$$

Normally the resonance frequency between the capacitor and the series reactance is shifted lower than 250Hz and it is generally between 135Hz and 210Hz. The lower frequencies correspond to higher harmonic loads.

The installation of a reactance in series with the capacitor bank produces a series resonance frequency:

$$f_{rs} = \frac{1}{2 * \pi * \sqrt{L_f * C}}$$

If a harmonic current  $I_h$  with the same frequency of the resonance in series exists, this one will be totally absorbed by the system capacitors - reactors without any effect on the network. The realisation of a **tuned passive filter** is based on this simple principle. This application is required when we want the reduction of the total distortion in current (THD) on the system:

$$THD = \frac{\sqrt{I_3^2 + I_5^2 + I_7^2 + \dots + I_n^2}}{I_1}$$

$I_1$  = Component at the fundamental frequency (50Hz) of the total harmonic current

$I_3, I_5, \dots$  = Harmonic components at the multiple frequency of the fundamental (150Hz, 250Hz, 350Hz, ...)

The dimensioning of tuned/passive filters is linked to the circuit parameter:

- impedance of the network (attenuation effect less as the short-circuit power on the network increases: in some cases could be useful to add in series with the network a reactance to increase the filtering effect)
- presence of further loads that generate harmonics linked to other nodes on the network
- capacitor types.

On this last point we have to make some considerations.

It is known that the capacitors tend to decrease capacity over time: varying the capacity inevitably varies the resonance series frequency

$$f_{rs} = \frac{1}{2 * \pi * \sqrt{L_f * C}}$$

and this drawback can be very dangerous because the system could lead in parallel resonance conditions. In this case, the filter does not absorb more harmonics but even amplifies them. In order to have a constant capacity guarantee over time we need to use another type of capacitors made in bimetalized paper and oil impregnated polypropylene. In addition to the passive absorption filter realized with capacitors and inductances is possible to eliminate the network harmonics, with another type of absorption filter: the Active Filter. The operation principle is based on the in-line injection of the same current harmonics produced by non-linear loads, but out of phase.

## Power factor correction in presence of distorted voltage

In many industrial electrical systems or in the tertiary sector, the presence of non-linear loads (inverter, welding, filament free lamps, computers, drives, etc..) causes a distortion of the current, which is synthesized by the THDI% numeric parameter: if the current is sinusoidal his THDI% is zero, more the current is deformed so much higher is its THDI%. In electrical currents with very deformed currents, the power factor correction equipment are carried out in a "filter banks" (or "block" or "blocked" or "detuned" if you prefer), or rather with inductors that prevent harmonic current to reach and damage the capacitor.

Usually the supply voltage remains sinusoidal even if a very deformed current flows in the plant; however, if the MV/LV transformer impedance is high, the voltage may also

be affected by deformation: this impedance, crossed by a distorted current, will create a voltage drop equally distorted, causing on LV users a non-sinusoidal supply voltage (or with a certain THDV%). It is rare that the THDV% reaches 8% (limit of IEC EN 50160), this happens for example when the MV/LV transformer is characterized by a high series impedance and/or is overloaded (saturation).

In a plant with distorted voltage there will be problems of various types, depending on the utilities (breakage or malfunction of electronic parts such as relays, plc, controller, computers; production beyond the acceptable tolerances, etc.). Regarding the power factor correction, a high THDV% creates problems for the blocking reactors used in power factor correction banks.

These can saturate and overheat for overload up to be damaged, causing the out of service of the power factor correction bank and/or problems to the capacitors. This will result in an economic loss (payment of penalties for low cos phi) and technical, because the plant will run through by a higher current, resulting in conductors additional overhead (cables, bars) and the transformer. For this problem, ICAR has developed a dedicated solution: the MULTImatic FD25V (for 400V network) and FD70V (for 690V network) power factor correction ranges. They are made with sound heavy duty-bimetalized paper capacitors with high performance electronic instrumentation for the electrical parameters control; high linearity reactance allow them to bear up to 8% THDV continuously.

## Power factor correction in the presence of a photovoltaic system in spot trading

If on electrical plant of an industrial user is added a photovoltaic system, the active power drawn from the supply is reduced because of the power supplied by the photovoltaic system and consumed by the plant (consumption).

Therefore, it changes the relationship between reactive power and active energy drawn from the network and, consequently, the power factor is lower than the same system without photovoltaic. We must therefore pay particular attention to the power factor correction not to have any penalties for low cos phi that could seriously erode the economic benefits of the photovoltaic system.

The power factor correction will be reviewed both for installed capacity, both for construction type. In fact, increasing the power factor corrector power, you will modify the resonance conditions with the MV/LV transformer which supply the system. When the photovoltaic system has more power than the users one, or if it is possible that power is introduced to the network, the power factor corrector must also be able to run on the four quadrants. The two "standard" quadrants are related to the plant operation as a user that absorbs from the network both active and inductive reactive power, while the two quadrants related on the plant functioning as a generator, it provides the network active power, but it absorbs the inductive reactive power (quadrants of generation).

All ICAR range of cos phi electronic controllers are able to operate in four quadrants, running two different cos phi targets to optimize the system economic performance. To manage the cogeneration quadrants you can alter some parameters settings. It is advisable to enter a value equal to 1, to optimize the yield of the PFC Bank. Refer to the manuals of the controllers for more details. To get the maximum benefit in the time allowed by the PFC Bank, we recommend to use bimetalized paper capacitors, the only ones that guarantee a useful life comparable to the photovoltaic system one.

# Power factor correction: quality and safety

## Basic requirement

We define safety the absence of dangers for people and things while the good is in use or stored in a warehouse. This means to identify stresses, risks and potential damages and the relevant elimination and to keep them under control so that to reduce the risk to a reasonable level.

Power capacitors and capacitor banks shall not be used:

- For uses other than Power Factor Correction and for AC or DC plants
- As tuned or detuned filters unless specifically approved in written by ICAR.

## General requirement

The capacitors are constructed in accordance with IEC – CEI EN methods, parameters and tests. The low voltage capacitors are assembled with the required protection devices and assembled into banks to give a QUALITY product which will operate SAFELY. They are not considered as the indication that the capacitors and the power factor correction equipments are suitable for a use in the same conditions of the tests. The user has to verify that the capacitor and power factor correction equipment are of the correct voltage and frequency suitable for values of the network on which they are installed. The user has to verify that the installation of the capacitors and/or the power factor correction equipment is in accordance with the catalogue and the instructions of use. Capacitors and power factor correction equipment MUST NOT be exposed to damaging action of chemical substance or to attacks of flora and/or fauna. Capacitors and power factor correction equipments must be protected against risks of mechanical damaging to which could be exposed during normal working conditions or during the installation. Capacitors and power factor correction equipments that were mechanically or electrically damaged for any reason during the transport, the storage or the installation must not be used and these that breakdown during use must be immediately removed.

## Additional instructions about power factor correction equipments

### Definition

Power factor correction equipment means:

- One or more groups of capacitors that can be connected and disconnected on the network automatically or manually using suitable operating devices (contactors, circuit breakers, load-break switch, ...)
- Operating devices
- Control, protection and measure systems
- Connections.

The equipment could be open or closed inside a metal enclosure.

### General requirement

Follow ICAR instructions in the documentation attached to equipments considering the safe distance, the connection standard criteria, working standards and the instructions for the controls and the maintenance.

### Compatibility

It must be paid attention to the electromagnetic interferences with the near by equipments.

### Contactors

It is advisable to adopt capacitor duty contactors (category AC6-b) because they are equipped with pre charge resistors that substantially reduce the inrush currents while capacitors are switched on. The early switching on of these resistors in respect

to the closing or the contactor contacts, allows:

- To avoid main contacts melting.
- To avoid capacitor damage.

## Recommendations for installation

### Fixing and connection

To fix the power factor correction equipments it is advised to use these types of screws:

- Riphaso series with M10 screw
- MICROmatic and MICROfix series wall-mounted with FISHER 8
- MINImatic wall-mounted and floor-mounted with M8 screw
- MULTImatic and MULTImatic HLP floor-mounted with M12 screw.

The installation of the power factor correction equipment is for indoor application; for different use call ICAR technical department.

### Protection devices

Operating devices (load-break switch) or operation and protection (circuit-breakers if the cables are longer than 3m) must be dimensioned to withstand capacitive currents (about 1.3 times nominal current), the inrush currents, the number of operations and they must be re-strike free.

The capacitors are made of polypropylene that is a flammable material. Even if a fire doesn't begin from capacitors or inside the panel, they could however spread it creating dangerous gasses. If a danger exists from the presence of an explosive or flammable atmosphere, the IEC standard; "Electric equipment with explosion and fire danger", shall be strictly followed.

### Danger for people

When we install power factor correction equipment we must pay attention that the parts which could be exposed to voltage are correctly protected from accidental contacts in accordance with IEC standards. Before the commissioning verify the tightening of the terminal and of all the bolts is correct.

## Protections

### Fuses and overpressure disconnecter

All the capacitors have an overpressure device which when operated, as in the case of breakdown, disconnects the element from use. This device is not a substitution for the fuses or external circuit-breakers that are specified in our power factor correction equipment.

## Limit conditions

The influence of each factor below has not to be considered individually, but in combination and with the influence of other factors.

### Voltage

Capacitor and capacitor bank nominal voltage is intended as the design and testing voltage.

The safe and proper use of power factor correction capacitors and capacitor banks, implies that the working voltage is not higher than the nominal voltage.

In special conditions, excluding the installation phases, higher over voltage are allowed as per below table (ref. IEC 60831).

Overvoltage factor (x U <sub>N</sub> eff)	Max. duration	Observations
1	Continuous	Highest average value during any period of capacitor energization. For energization period less than 24h, exceptions apply as indicated below
1,10	8h every 24h	System voltage regulation and fluctuation
1,15	30 min. every 24h	System voltage regulation and fluctuation
1,20	5 min	Voltage rise at light load
1,30	1 min	

**Note: for voltage without harmonics**

The life expectancy of capacitors and power factor correction equipment is greatly reduced when operating in overload conditions. The choice of the nominal voltage is determined by the following considerations:

- On some networks working voltage could be very different from nominal voltage
- Power factor correction equipment in parallel could cause an increase of the voltage at the connection point
- The voltage increases with the presence of harmonics on the network and/or  $\cos\phi$  of in advance
- The voltage at the capacitor terminals increases when capacitors are in series with reactors for harmonic blocking
- If the power factor correction equipment is connected to a motor and not sized correctly, when we disconnect it from the network we may have a phenomena caused by the inertia that makes the motor to work as a self-excited generator consequently increasing of the voltage level at the terminals of the equipment
- The remaining voltage caused by the self-excited after that the equip- ment has been disconnected from the network is dangerous for the generators
- If the power factor correction equipment is connected to a motor with a star-delta starting device we have to pay attention to not cause the overvoltage when this device is working
- All the power factor correction equipments exposed to overvoltage caused by atmospheric lightning must be protected in correct way. If surge arrestors are use they have to be placed as near as possible to the equipment.

### Working temperature

Working temperature of power factor correction equipment is a fundamental parameter for safe operation. As a consequence it is very important that heat generated is dissipated correctly and that the ventilation is such that the heat losses in the capacitors do not exceed the ambient temperature limits. The highest workings temperature in normal service conditions between two capacitors is measured at a point 2/3 of the capacitors height and at a distance of 0.1m from them. The capacitor temperature must not exceed the temperature limits hereinafter tabled.

Symbol	Ambient temperatures (°C)		
	Maximum	Highest mean over any period of:	
		24h	1 year
A	40	30	20
B	45	35	25
C	50	40	30
D	55	45	35

### Mechanical Limits

The user has not to expose the equipment to exaggerated mechanical limits of operation. The user has to pay attention to the electrical and geometrical dimensioning of the connections to avoid exceeding the mechanical limits which may be reached by temperature variation.

## Other considerations for the working safety

### Discharge device

Every capacitor must have a discharge device that can discharge it within 3 minutes. The discharge time is calculated from the starting peak of voltage equal to  $\sqrt{V_N}$  until 75V. Between the capacitor and the discharge system there shall not be a circuit-breaker, fuses or other sectioning devices.

This doesn't relief to short-circuit the capacitor terminals and earth every time it is required to handle the capacitor.

### Residual voltage

When the capacitor is placed under tension its residual voltage

must not exceed 10% of the rated voltage. This condition is generally satisfied when the power factor correction equipment is calibrated properly, the reactive power controller, reconnection time shall be appropriate to the discharge time.

### Case connection

To keep capacitors case at fix voltage and to discharge fault current toward the case itself, they are grounded by connecting to earth the capacitors supporting frame.

### Altitude

Power factor correction equipment must not be used above an altitude of 2000m. On the contrary please contact technical assistance of ICAR S.p.A.

### Particular ambient conditions

Power factor correction equipment are not suitable for the applications in places where there are conditions as follows:

- Fast generation of mould
- Caustic and saline atmosphere
- Presence of explosive materials or very flammable
- Vibrations

For environments with these characteristics: high relative humidity, high concentration of dust and atmospheric pollution, please contact technical assistance of ICAR S.p.A.

## Maintenance

After the disconnection of the bank, prior to accessing the terminals of the capacitors wait 5 minutes and then short-circuit the terminals and earth. Make these procedures:

Once a month:

- Cleanliness by blast of air of the internal part of the power factor correction equipment and of the air filter anytime there is a cooling system
- Visual control
- Control of the ambient temperature.

Once every 6 months:

- Control of the surfaces condition: painting or other treatments
- Control of the correct tightening of the screw (this operation must be done before the commissioning).

If there are concerns about any environmental conditions an appropriate maintenance program must be established (for example in a dusty environment could be necessary to clean using blasts of air more frequently).

Once a year

- Checking the contactors status
- Checking the capacitors status.

## Storage and handling

The power factor correction equipment handling must be made carefully avoiding the mechanical stresses and shocks.

The equipment in highest cabinet may be hard to handle, because the center of gravity may be very high and decentralized.

Upon receipt of new equipment, make sure that the packaging is not damaged, although mild. Always make sure that the equipment has not been damaged by transportation: take away the packaging and make a visual inspection with open door. If you discover some damage, write it on the delivery note (carrier copy) the reason for refusal or reserve.

The capacitors and power factor correction awaiting installation storage must be done leaving them in their original packaging, in a covered and dry place.

For more detail refer to specific product user's Manual.

# Selection criteria

## Capacitors used in power factor correction solutions

In our power factor correction systems we only use our capacitors production, made entirely from ICAR: in this way, we can offer to our customers the highest guarantee of the equipment reliability. The capacitors used are divided into three different types, which lead to electrical and thermal performance completely different:



### Polypropylene standard capacitors

They are made by wrapping a metallized polypropylene film.

In function of the film thickness, the layer of metal deposited on the surface and the number of windings made, you get the desired characteristics of capacity, rated voltage, withstand overcurrents etc.

According to the characteristics, the polypropylene standard capacitors are used in power factor correctors SP20, RP10, RP20 families.



### High gradient metallized

#### polypropylene capacitors

The substantial difference with the standard polypropylene capacitors is the mode with which the dielectric film is metallized: in the standard capacitors the metal layer thickness deposited on the surface of the film is constant, for those "high gradient" the metal layer has a suitably modulated thickness.

The metallization thickness modulation allows to greatly improve the capacitors (and therefore of the power factor correction systems which are the fundamental component) in terms of:

- Increase in power density (kvar/dm<sup>3</sup>) with a consequent power size reduction of the power factor correction systems
- Robustness improvement against voltage surges, for greater reliability even in systems with the presence of voltage fluctuations due to the network or maneuvers on the system
- Improved behavior of the internal short circuit withstand.

According to the characteristics, the metallized polypropylene capacitors are used in high gradient power factor correctors HP10, HP20, HP30, FH20 and FH30 families.



### Bimetalized paper capacitors

The bimetalized and impregnated paper capacitors are now the most robust solution for industrial power factor correction.

They are made by wrapping a thin sheet of special paper on the surfaces of which is deposited by evaporation process, a infinitesimal layer of metal alloy with function of electrode; between the sheets of paper is placed a polypropylene film with only the dielectric role between electrode. The bimetalized paper capacitors robustness is due to the already excellent mechanical paper characteristics, to which are added the impregnation in oil benefits. This technology, among the most tested for the capacitors production, was also adopted to realize capacitors used in power electronics, since solicited with high frequencies and designed to work with high temperatures.



The ICAR bimetalized paper capacitors are particularly suitable for applications in plants with high harmonic content currents and/or high operating temperatures; they are used for the detuned filters realization for "troubled" installations because, thanks to the steady capacitance throughout the useful life, these capacitors are able to keep in time the tuning of the filter frequency, even in high operating temperatures presence.

In function of the characteristics, the bimetalized paper capacitors are used in TC10, TC20, FD25, FD35, etc. families.

Our paper bimetalized capacitors are, today, the most imitated... but just look at the construction characteristics detail of what is proposed as "3In" or "4In" to realize that they are simple polypropylene capacitors, maybe just a little "strengthened".

By their nature, they cannot even come close to the technology "bimetalized paper" performance, especially as regards the maximum operating temperature.

Summing up, the main different types of capacitors features are shown in the table below.

Capacitor technology	Life expectancy	Loss of capacitance	Voltage withstand	Allowed current overload	Peak current withstand	Overall reliability	Maximum working temperature
 Standard polypropylene	very good	low	good	good	good	good	55°C
 High voltage polypropylene	very good	low	excellent	very good	very good	very good	55°C
 Metallized paper	excellent	negligible	very good	excellent	excellent	excellent	<b>70°C</b>

Maximum working temperature is meant capacitor surrounding air temperature.



# APFC banks components and solutions

In the majority of industrial plants the power factor correction system is centralized, with high capacity capacitor banks usually equipped with harmonic blocking reactors to protect capacitors from harmonics in the current.

When choosing a capacitor bank, it is necessary to pay attention not only to the quality of the capacitors inside the cabinet, but also to the quality of the other components and to the different solutions adopted by the manufacturer, in order to choose a device which will be efficient, long-lasting and easy to maintain.

## Regulator:

the intelligent element, which controls the capacitor bank, so it is very important. It is better to choose regulators with microprocessor, equipped with several measuring and alarm functions: you will appreciate it a lot during the capacitor bank's life.

## Internal structure:

it is preferable to choose a capacitor bank with removable racks: it's the best way to reduce time and problems during maintenance.

## Contactors

In order to guarantee excellent long life and reliability, must be of good manufacture. For standard PFC systems, contactors have to be with damping resistors to limit capacitors inrush current (AC6b), for detuned PFC systems are enough standard contactors (the function of the peak smoothing It is performed by the blocking reactance).

## Load break switch:

it is the operation element, the one which has to bear the current of the capacitor bank also in case of overload. According to CEI EN 60831-1 regulation it has to be dimensioned with a nominal current which is at least 1,5 times the nominal current of the capacitor bank.

## Ventilation:

it is preferable to choose capacitor banks with forced ventilation, which reduces the thermal stress on the capacitors. This leads to a longer life of the capacitor bank, therefore to a better economic result.



## Steps:

the criteria of the division of supplied power is fundamental to have a higher precision in compensation. It is always preferable to choose capacitor banks with a high number of steps.

## Harmonic blocking reactors:

in capacitor banks operating with distorted currents, reactors (if they are of good quality, with a high linearity) protect capacitors from the harmonics in the current.

In detuned capacitor banks, the lower the resonance frequency (a capacitor bank with  $f_D=180\text{Hz}$  is better than one with  $f_D=189\text{Hz}$ ) the better the blocking capability.

Moreover, because of Ferranti effect, voltage applied on the capacitors grows: therefore, it is better that capacitors have a higher voltage, when technologies are equal (in the case of polypropylene capacitors it is better to choose 550V).

## Filters for the ventilation system:

they protect the capacitor bank from the entrance of dust and foreign bodies, which could worsen its thermal situation.

## FIX POWER FACTOR CORRECTION SYSTEMS



### CRTE

The simplest and most efficient fixed power factor correction is three-phase capacitor. Available from 1kvar to 50kvar at 400V or higher voltages (up to 800V). See dedicated catalog.



### SUPERriphaso

Fixed Power factor correction for three-phase systems, modular plastic housing with IP40 protection degree. The modularity of the family SUPERRiphaso allows to obtain the necessary power composing more modules with a simple and quick electrical and mechanical connection. For powers from 5 to 50kvar at 400V. The SUPERRiphaso can only be installed in a vertical position, as shown in picture.



### Riphaso

Fixed Power factor correction for three-phase systems, metal housing with IP3X protection degree; sheet metal coated with epoxy paint. For powers from 5 to 50kvar at 400V. Riphaso is also available with blocking reactors, with power ratings up to 25kvar at 400V. The Riphaso can only be installed in a vertical position, as shown in the picture.



### MICROfix

Power factor correction for fixed three-phase systems, in metal enclosure with IP3X protection degree. MICROfix is equipped with a integrated door lock isolating switch, signal lamps and fuses. For power up to 60kvar at 400V.



### MINIfix – MULTIfix

Fixed power factor correction systems for higher powers are made with equipment derived from the MINImatic and MULTImatic series, depending on the power demand. The reactive power on board is still managed in step, is that at the time of insertion or the disconnection, to reduce the stress system.

## AUTOMATIC POWER FACTOR CORRECTION SYSTEMS



### MICROmatic

It is the smaller size of automatic power factor correction bank, suitable for small users power factor correction. It is made with modular concept (MICROrack) to simplify the management of spare parts and maintenance. For reactive power up to 64kvar at 400V in very small dimensions. Allows you to have up to 19 steps for optimal power factor correction in the presence of highly variable loads or characterized by long periods of "no load" operation. The HP10 family is also available in FAST version for small loads fast power factor correction (lifts, elevators, car washes, etc.).



### MINImatic

For small/medium powers automatic power factor correction, can deliver up to 225kvar 400V, depending on the version. Is made with completely removable rack (MINIRack) to simplify management and maintenance. Very flexible Framework, allows the realization of many variations as shown in the available options table. MINImatic is also available in a version with harmonic blocking reactors and cable entry from bottom.



### MIDImatic

Automatic power factor correction medium power, can deliver up to 480kvar at 400V depending on the version. It is made with easily removable rack, and wiring of the auxiliary plug-in power distribution is with robust copper bars. Choice of cable entry (top/bottom).



### MULTImatic

Power factor correction automatic for large users, allows systems of up to several Mvar, with master-slave logic. MULTImatic is made rack (MULTItrack) for easy replacement and maintenance. It is available in SPEED series (for fast loads), detuned or tuned, in the degrees of protection IP 4X standard, IP55, with cable entry from top or bottom. The distribution of power is with robust copper bars. Frameworks of standard equipments made from multiple columns side by side are equipped with a disconnecter and a cable entry in each column. ICAR can make framework on multiple columns with one single cable entry.

## Automatic Capacitor Banks Standard features

These are the common features to all automatic banks: PFC regulator with temperature control, IP3X degree of protection, RAL 7035 cabinet paint color, Working voltage  $U_e$  of 400V\*.



	MICROmatic	MINImatic	MIDImatic	MULTImatic
<b>Cable incoming</b>	top/bottom	top	bottom	bottom
<b>Ventilation</b>	forced	forced	forced	forced
<b>PFC controller</b>	RPC 5LGA	RPC 5LGA	RPC 8LGA	RPC 8BGA

\* For  $U_e$  working voltage other than 400V please consult us.

## Optional for automatic PFC banks

	MICROmatic	MINImatic	MIDImatic	MULTImatic
<b>Cable incoming top/bottom</b>	yes	yes (4)	yes (4)	yes (4)
<b>IP55 Degree of protection cabinet (cable incoming)</b>	no	yes (Bottom)	no	yes
<b>Remote Communication (1)</b>	yes	yes	yes	yes
<b>Control and protection module MCP (2)</b>	no	yes (5)	yes (FH20)	yes (2)
<b>Other paint color (upon request)</b>	yes	yes	yes	yes
<b>Automatic Circuit Breaker</b>	no	yes	yes	yes

	MICROmatic	MINImatic	MIDImatic	MULTImatic
<b>Fuse melting signaling</b>	no	yes	no	yes
<b>Other Short Circuit fault withstand level</b>	no	yes	yes	yes
<b>Thyristor Switched bank (3)</b>	no	no	no	yes
<b>Controller Remote Software</b>	yes	yes	yes	yes
<b>Modem for Remote Control</b>	no	no	yes	yes
<b>Fused Main Switch</b>	no	yes	yes	yes

### Notes

(1): The RPC 8BGA regulator mounted on MULTImatic can be equipped with additional modules to communicate: RS 485 ModBus or Profinet, Ethernet, modem GSM/GPRS network

(2): For better protection of power factor correction system against max THD, Max Temp, MULTImatic of FH20, FH30, FD25, FD25V, FD35 "detuned" families are equipped in standard with integrated MCP5 in the RPC 8BGA controller

(3): The static switches replace the normal electromechanical contactors and allow the  $\cos \varphi$  quick adjustment even in the presence of loads with sudden changes in absorption (welding machines, mixers, ovens, etc.)

(4): To be specified in the order

(5): Contact us.

## Thyristor Switched Capacitor Banks

The MIDImatic and MULTImatic ranges can be made with thyristor switches. Compared to traditional power factor correction systems, enables obtaining interesting performances thanks to the reaction speed of thyristors, (SCR) that control capacitors banks/steps.

By this solution the following performances are available:

- Switching speed: all the reactive power of the bank can be switched in about 60 ms. This is particularly suitable for plants characterized by fast changing loads (mixers, robots, welders) that could create problems to traditional electromechanic contactors used in standard power factor correction banks
- Capacitor switching with minimization of the transient current peak
- Particularly suitable for plants which power factor correction banks has to perform a great numbers of manoeuvres and in presence of devices sensitive to transient over voltage/currents
- Silence: with no mechanical components on the move, the real time capacitor banks are really suitable for applications where the installation of the power factor correction switchboard occurs near places which require minimum noises (banks, data elaboration centres, theatres, cinemas, libraries, schools)
- Reduced maintenance: the lack of mechanical parts reduces the stress on the switchboard which therefore needs a little periodical maintenance compare to systems with traditional electromechanical contactors. This characteristic is really useful in rooms with conducting powder that could through the conductors into crises.

## Power Factor Correction Tuned Filters

MINImatic and MULTImatic can be used for perform harmonic filtering. They are banks with reactance connected in series to the capacitors. The LC circuit made in this way, has a network resonant frequency that is different from the network frequency (50Hz) and depending on the electric values of the components used (resistance, capacity, inductance) are obtained "detuned" filters or "absorption" filters. These are preferable solutions for those plants characterized by the presence of harmonics due to distorting loads (lighting, power electronics, induction ovens, welders etc), for the reasons described below.

### Blocking (detuned) filters

The detuned filters are designed to power factor correction of a system characterized by the presence of harmonics, "protecting" the capacitors that would be damaged. The addition of the filter does not change the system harmonic content: the harmonics will continue to flow without "enter" into power factor corrector. The blocking filters have a tuning frequency lower than that of the harmonic current that circulates in the system with lower order. Typically, the tuning frequency ( $f_N$ ) is 180-190Hz, and the blocking filter is much more robust the lower the  $f_N$ . In systems with particularly high harmonic content, we realize blocking filters tuned to 135Hz and therefore particularly sound.

### Absorption passive filters

Absorption filters are meant for plant power factor correction capacitors and, at the same time, totally or partially solve the problem of plant harmonics. The filter is tuned near the harmonic frequency to be eliminated, (for example 250Hz to eliminate the 5th harmonic) and, consequently, that current will almost completely flow in the filter, leaving the electric circuit "clean". Usually the absorption filter is realized after a careful analysis of the circuit and a measurement campaign of the harmonics in order to come up with a solution really "ad hoc".

## Power factor correction for high voltages systems ( $\geq 550V$ )

The power factor correction systems for applications in nominal voltages of 600/660/690V (eg. voltages used for mining, highway tunnels and rail cargoes on board ship, port cranes, steel mills, paper mills and other "heavy" applications) can be realized in different ways as follows.

### Capacitors star connection

A widely used mode embodiment, but risky, provides a capacitors star connection (fig 1): in this way capacitors are subjected to a voltage equal to the nominal plant divided by  $\sqrt{3}$ .

- Advantages: you can then use capacitors smaller and cheaper, getting more compact and lightweight frameworks
- Disadvantages: in case the capacity of the capacitors degradations, a phenomenon that is intended, however, to take place, the voltage across the capacitors of the star will no longer be balanced but will increase on the side with greater capacity degrades up to reach values higher than the rated voltage of the capacitors themselves. In this situation, the risk of overvoltage with possible consequent capacitors explosion/fire increases dramatically.

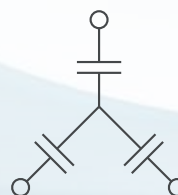

Fig 1: Capacitors star connection

### Using capacitors at full rated voltage, delta-connected

This solution calls for the use of capacitors with a voltage rating at least equal to that of the network, as can be seen in Figure 2.

- Advantages: equipment electrically robust. Even in case of loss of capacity of a capacitor, the other does not suffer any consequences: you reset the malfunctions risks and capacitors damage
- Disadvantages: cabinet bulkier and heavier, with higher costs.

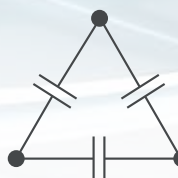

Fig 2: Capacitors delta connection

### The ICAR way

ICAR APFC banks for working voltages higher than 550V are made with delta connected capacitors, and so they have a nominal voltage higher than the system network working voltage; this is the most sound and reliable solution. To improve power factor of 690V plants, ICAR uses 900V polypropylene or metallized paper capacitors.

# Selection criteria depending on the type of plant

The choice of power factor correction equipment must be made by evaluating the design data of the system or, better yet, your electricity bills. The choice of the power factor correction type must be carried out according to the following table, which shows on the ordinate the rate of harmonic distortion of the plant current (THDI<sub>R</sub>%) and in abscissa the ratio between the reactive power Q<sub>C</sub> (in kvar) of the PFC bank and LV/MV transformer apparent power (kVA).

In light of these data, it identifies the box with proposed families, starting from the family that ensures the proper functioning with the best quality/price ratio.

So you choose the automatic power factor corrector series. The fixed power factor correction must have the same electrical characteristics of the automatic (eg, automatic FH20, fixed FD20; automatic HP10, fixed SP20).

The table was made starting from the following assumptions:

- Network voltage 400V
- Initial power factor of the plant 0.7 inductive
- Power factor target 0.95 inductive
- Non linear load with 5°-7°-11°-13° harmonics current.

The hypotheses used are general and valid in the most of cases. In particular situations (harmonics coming from other branch of network, presence of rank equal to or a multiple of 3 harmonics) previous considerations may be invalid.

In these cases, the guarantee of a correct choice of the equipment occurs only as a result of a measurement campaign of harmonic analysis of the network and/or the appropriate calculations. ICAR disclaims any responsibility for incorrect choice of the product.

## Automatic PFC systems selection guidelines

<b>THDIR% &gt; 27</b>	HP10/HP20/TC10	FH20/FH30/FD25	FH20/FH30/FD25	FH20/FH30/FD25	FH20/FH30/FD25	FH20/FH30/FD25	FH20/FH30/FD25
<b>20 &lt; THDIR% ≤ 27</b>	HP10/HP20/TC10	FH20/FH30/FD25	FH20/FH30/FD25	HP20/HP30/TC20	HP30/TC20/FH20	FH20/FH30/FD25	FH20/FH30/FD25
<b>12 &lt; THDIR% ≤ 20</b>	HP10/HP20/TC10	FH20/FH30/FD25	FH20/FH30/FD25	HP20/HP30/TC20	HP20/HP30/TC20	FH20/FH30/FD25	FH20/FH30/FD25
<b>THDIR% ≤ 12</b>	HP10/HP20/TC10	HP20/HP30/TC20	HP30/TC20/FH20	HP10/HP20/TC10	HP20/HP30/TC20	HP30/TC20/FH20	FH20/FH30/FD25
	<b>Q<sub>C</sub> / A<sub>T</sub> ≤ 0,05</b>	<b>0,05 &lt; Q<sub>C</sub> / A<sub>T</sub> ≤ 0,1</b>	<b>0,1 &lt; Q<sub>C</sub> / A<sub>T</sub> ≤ 0,15</b>	<b>0,15 &lt; Q<sub>C</sub> / A<sub>T</sub> ≤ 0,2</b>	<b>0,2 &lt; Q<sub>C</sub> / A<sub>T</sub> ≤ 0,25</b>	<b>0,25 &lt; Q<sub>C</sub> / A<sub>T</sub> ≤ 0,3</b>	<b>Q<sub>C</sub> / A<sub>T</sub> &gt; 0,3</b>

## Fix PFC systems selection guidelines

<b>THDIR% &gt; 25</b>	SP20/RP10/TC10	FD20/FD30/FD25	FD20/FD30/FD25	FD20/FD30/FD25	FD20/FD30/FD25	FD20/FD30/FD25	FD20/FD30/FD25
<b>15 &lt; THDIR% ≤ 25</b>	SP20/RP10/TC10	FD20/FD30/FD25	FD20/FD30/FD25	RP10/RP20/TC20	RP20/TC20/FD25	FD20/FD30/FD25	FD20/FD30/FD25
<b>7 &lt; THDIR% ≤ 15</b>	SP20/RP10/TC10	FD20/FD30/FD25	FD20/FD30/FD25	RP10/RP20/TC20	RP10/RP20/TC20	FD20/FD30/FD25	FD20/FD30/FD25
<b>THDIR% ≤ 7</b>	SP20/RP10/TC10	RP10/RP20/TC10	RP20/TC20/FD20	SP20/RP10/TC10	RP10/RP20/TC20	RP20/TC20/FD20	FD20/FD30/FD25
	<b>Q<sub>C</sub> / A<sub>T</sub> ≤ 0,05</b>	<b>0,05 &lt; Q<sub>C</sub> / A<sub>T</sub> ≤ 0,1</b>	<b>0,1 &lt; Q<sub>C</sub> / A<sub>T</sub> ≤ 0,15</b>	<b>0,15 &lt; Q<sub>C</sub> / A<sub>T</sub> ≤ 0,2</b>	<b>0,2 &lt; Q<sub>C</sub> / A<sub>T</sub> ≤ 0,25</b>	<b>0,25 &lt; Q<sub>C</sub> / A<sub>T</sub> ≤ 0,3</b>	<b>Q<sub>C</sub> / A<sub>T</sub> &gt; 0,3</b>

## Application Example

For example, consider a MV connected system through a LV/MV 1000kVA transformer, and with a THDI<sub>R</sub>% equal to 25%. Assuming that the power factor correction system to be installed has a reactive power of 220kvar, the ratio Q<sub>C</sub>/A<sub>T</sub> is equal to 0.22.









The recommended power factor correction is therefore that in the box identified from the abscissa 0.2 < Q<sub>C</sub> / A<sub>T</sub> ≤ 0.25 and the ordinate 20 < THDI<sub>R</sub> ≤ 27%.

You can choose an HP30 family device, or go to the TC20 family or, for even greater reliability of the solution, choose the FH20 family.

## Standard power factor correction

The standard power factor correction is used in those plants where there are no current heavily deformed (verify the THD% data of the system current, which must be less than  $THDI_R\%$  of the selected power factor correction family) or resonance problems (see the table selection criteria).

If the harmonics presence in the plant is not negligible, are preferred solutions with reinforced capacitors (i.e. with an higher nominal voltage than that of the network). In case of use in systems with heavy duty cycle, or in the case of installation in cabinets with high temperature, solutions with bimetalized papercapacitors are preferred.

			FIX			AUTOMATIC			
									
Capacitor construction technology	Range and Nominal values		SUPER riphaso 5÷50kvar	Riphaso 5÷50kvar	MICRO fix 5÷50kvar	MICRO matic 10÷65kvar	MINI matic 70÷225kvar	MIDI matic 240÷450kvar	MULTI matic from 165kvar
 Polypropylene standard	SP20	$THDI_R\%=7\%$ $THDI_C\%=40\%$ $U_N=400V$	✓	✓	✓				
 Polypropylene standard	RP10	$THDI_R\%=15\%$ $THDI_C\%=60\%$ $U_N=460V$	✓	✓	✓				
 Polypropylene standard	RP20	$THDI_R\%=20\%$ $THDI_C\%=70\%$ $U_N=550V$	✓	✓	✓				
 High Energy Density Polypropylene	HP10	$THDI_R\%=12\%$ $THDI_C\%=50\%$ $U_N=415V$				✓	✓	✓	✓
 High Energy Density Polypropylene	HP20	$THDI_R\%=20\%$ $THDI_C\%=70\%$ $U_N=460V$				✓	✓	✓	✓
 High Energy Density Polypropylene	HP30	$THDI_R\%=27\%$ $THDI_C\%=85\%$ $U_N=550V$					✓		✓
 Metallized Paper	TC10	$THDI_R\%=27\%$ $THDI_C\%=85\%$ $U_N=400V$	✓	✓	✓	✓	✓		✓
 Metallized Paper	TC20	$THDI_R\%=27\%$ $THDI_C\%=90\%$ $U_N=460V$	✓	✓	✓		✓		✓

This table is meant for standard 400V working voltage capacitor bank. For higher voltage plants, please consult ICAR.

## Power factor correction with blocking reactors







The power factor correction with blocking reactors (this solution is called in different ways in the technical literature such as "blocking filters", or "detuned filters", or "detuned power factor correctors", etc.) is a solution used when a current flows in the electric system with a high harmonic content (THD) and / or with the resonance risk with the MV/LV transformer. In these cases, the installation of a "normal" power factor corrector, devoid of blocking reactors, can cause the rapid degradation of the capacitors and cause dangerous electrical and mechanical stresses in the components of power plant (cables, busbars, switches, transformers).

Chokes protect the capacitors by harmonics and at the same time exclude the resonances risk; leave without sacrificing the harmonic content of the current system \*.

\* If you want to reduce the system harmonic content, you must install active or passive filters. Consult us.

This type of power factor correction is therefore to be preferred for systems with important non-linear loads (lighting not luminescent, power electronics, VSD, soft starters, induction furnaces, welding machines...).

ICAR offers two types of solutions with power factor correction with blocking reactors: one with 180Hz blocking frequency (detuned to 3.6 times the line frequency) and another one with 135Hz (2.7). It's correct noting that the lower the tuning frequency is the more robust is the cabinet, because the reactor should have a larger iron core. ICAR power factor correction with blocking reactor, solutions are made with capacitors and inductors produced in the group; also are used only capacitors with rated voltage higher than that of the network, to ensure strength and durability counteracting the Ferranti effect (permanent overvoltage on the capacitor due to the blocking inductance).

		FIX			AUTOMATIC			
		SUPER riphaso	Riphaso 20÷25kvar	MICRO fix	MICRO matic	MINI matic 10÷80kvar	MIDI matic 110 -220kvar	MULTI matic from 100kvar
Capacitor construction technology	Range and Nominal values							
	Polypropylene standard FD20 THDI <sub>R</sub> %<60% THDV%<6% U <sub>N</sub> =550V f <sub>N</sub> =180Hz (n=3,6)		✓					
	Polypropylene standard FD30 THDI <sub>R</sub> %>60% THDV%<6% U <sub>N</sub> =550V f <sub>N</sub> =135Hz (n=2,7)		✓					
	High Energy Density Polypropylene FH20 THDI <sub>R</sub> %<60% THDV%<6% U <sub>N</sub> =550V f <sub>N</sub> =180Hz (n=3,6)					✓	✓	✓
	High Energy Density Polypropylene FH30 THDI <sub>R</sub> %>60% THDV%<6% U <sub>N</sub> =550V f <sub>N</sub> =135Hz (n=2,7)					✓		✓
	Metallized Paper FD25 THDI <sub>R</sub> %<60% THDV%<6% U <sub>N</sub> =460V f <sub>N</sub> =180Hz (n=3,6)		✓					✓
	Metallized Paper FD35 THDI <sub>R</sub> %>60% THDV%<6% U <sub>N</sub> =550V f <sub>N</sub> =135Hz (n=2,7)		✓					✓

This table is meant for standard 400V working voltage capacitor bank. For higher voltage plants, please consult ICAR. For plant having high voltage distortion (THDV%>6%) ICAR can offer the special range FD25V. Please ask our sales department for details

# Selection of the CT, its position and how to connect it to the APFC bank

The electronic regulator installed on the capacitor bank calculates the power factor of the plant that has to be corrected by measuring a phase to phase voltage and the related 90° lagging current. The wiring which is necessary to obtain the signal is realized inside the APFC bank, therefore for a correct operation it is necessary to properly choose, position and wire the CT, which is not included in the capacitor bank.

The CT has to be chosen according to the characteristics of the load that has to be compensated and to the distance between its point of installation and the regulator:

- The primary of the CT has to be chosen according to the current absorbed by the loads that have to be compensated; it does not depend on the power of the APFC bank. The primary has to be approximately the same (or slightly higher) of the maximum current which can be absorbed by the load. However it is better not to choose a CT with an excessive primary: if this happens, when the load will absorb a limited current the CT will supply to the secondary a current which will be too weak to be calculated by the regulator. For example, if the load that has to be compensated has a maximum absorption of 90A, it is advisable to choose a CT with a 100A primary
- The secondary of the CT must be 5A. If you want to use a CT with 1A secondary you will have to parameterize the regulator
- The performance of the CT (apparent power) must be chosen taking into consideration the dissipation of the cable which connects the CT to the APFC bank. The table below shows how many VA are dissipated for each linear meter of a cable with different sections: to correctly calculate the wiring dissipation you need to consider the total route of the cable (way there and way back)

Cable section (mm <sup>2</sup> )	VA for each meter of cable at 20°C <sup>1</sup>
2,5 <sup>2</sup>	0,41
4	0,254
6	0,169
10	0,0975
16	0,062

1. For each 10°C of temperature variation, the VA absorbed by the cables increase by 4%, the above values are extracted from the typical resistance of flexible A class cables
2. Minimum section for the connection of cables between current transformer and regulator.

- The precision of the CT is very important to avoid problems of bad functioning of the APFC bank. Choose class 1 CT or, even better, class 0,5.

The wiring has to be carried out with an appropriate section, to not excessively weaken the signal coming from the secondary of the CT: choose a 2,5mm<sup>2</sup> cable section only if the wiring between the CT and regulator is 1 m max. Use cable section at least 4mm<sup>2</sup> for wirings up to 10m, 6mm<sup>2</sup> up to 20m and 10 mm<sup>2</sup> for more than 20m wirings. Connect to earth one of the two clamps of the CT. It is strongly recommended to use a dedicated CT for the APFC bank, to avoid to put in series more than one device (ammeter, multimeter) on the same CT.

## Position of the CT

As before mentioned, the electronic regulator installed on the APFC bank accurately calculates the cos phi of the plant if it can measure a phase to phase voltage and the related 90° lagging current. Since the wiring is already internally carried out on the APFC bank on L2 and L3 phases downstream the load break switch (clamps 9 and 10, see the scheme), the CT must be positioned on phase L1 of the power cable upstream the APFC bank (below image, in green). The side of the CT with P1 (or K) mark has to be oriented to the line (upstream). The wiring of the secondary of the CT (clamps S1 and S2) to the APFC bank (clamps L and K) is made by the customer, according to the instructions in the previous points\*.

Please note that possible positions here below indicated in red are wrong because:

1. The CT is downstream the APFC bank
2. The CT is on the wrong phase (L2)
3. The CT is on the wrong phase (L3)
4. The CT is installed on the cable that goes to the APFC bank.

For further information read the regulator's manual.



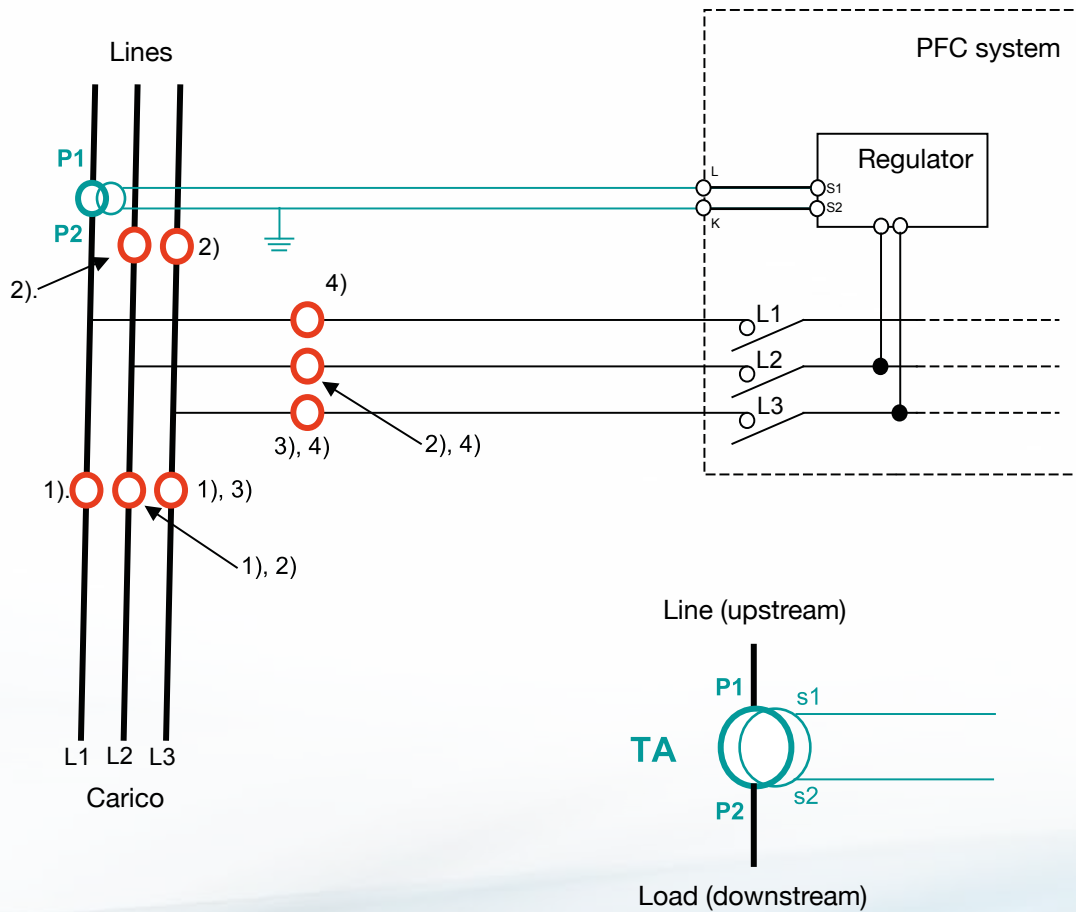

## Selection of APFC bank protection device rated current

The low Voltage APFC bank equipped with self-healing capacitors are compliant with IEC EN 60831-1/2 (capacitors) and IEC EN 61439-1/2, IEC EN 61921-1 (complete devices) regulations.

According the above-mentioned regulations, the capacitor bank must be able to work in continuous supporting:

- a) An RMS value of 1,3 times the nominal current (this regulation takes into consideration that, when harmonics are present in the system, capacitors are overloaded)
- b) A voltage 10% higher than the nominal value of the network, to cope with fluctuations of networks (see regulation IEC EN 50160).

Known this, and considering that APFC banks can have a tolerance on the nominal reactive power up to 5% more than nominal one (while for the single capacitors the tolerance on capacity is up to 10% more than nominal one), it is possible to indicate the calculation necessary for the choice and setup of the protection device to be installed upstream the APFC bank (Circuit Breaker or Fused Load Break Switch).

### Calculation of the current

Maximum absorbed current

$$I_{n_{max}} = 1,3 \times 1,1 \times 1,05 \times \frac{Q_n}{\sqrt{3} \times V_n} = 1,5 I_n$$

Where  $I_n$  is the nominal current of the device calculated with the data present on the label, that is to say  $V_n$  (nominal voltage of the network) and  $Q_n$  (nominal reactive power of the APFC bank at the nominal voltage of the network).

It is therefore necessary to choose and install a protection device (Circuit Breaker or Fused Load Break Switch) with current  $\geq$  or equal to  $I_{n_{max}}$  value according to which it has to be dimensioned the cable (or bars) which supply the APFC bank.

# Legend

- On board capacitors technology:
- standard polypropylene
  - high gradient polypropylene
  - bimetalized paper

Equipment type

Capacitors type

Common technical specifications

Available solutions

Short description

**AUTOMATIC POWER FACTOR CORRECTION SYSTEM**

HP10

U <sub>in</sub>	U <sub>o</sub>	U <sub>rated</sub>	I	THD <sub>v</sub> %	THD <sub>i</sub> %
400-415V	415V	400V	80-70	5%	50%



**GENERALITIES:**

- Die-cast metal enclosure painted with epoxidic dust paint, colour RAL 7035.
- Auxiliary transformer to separate power and auxiliary circuit parts (110V).
- Load-break switch with door interlock designed at 1.44E-1, 20 per IEC 60601-1 art. 64.
- Capacitors with damping resistors to limit capacitors inrush current.
- HOT-V-K self-extinguish cable according to IEC 20/22/1 and IEC 60672-2-1 standards.
- Microprocessor Power Factor Correction relay.
- Single phase self-healing metallized polypropylene capacitor with U<sub>rated</sub> 115V rated voltage.

All components inside the products are compliant with EU (RoHS).

**TECHNICAL CHARACTERISTICS:**

Rated operational voltage	U <sub>rated</sub> x 1.1
Rated frequency	50/60
Max current overload (in operation)	1.2xIn (continuous) 2xIn (x 300s) 3xIn (x 100s) 4xIn (x 60s)
Max voltage overload (in operation)	1.4xUn (x 1 min)
Max current overload (in bank)	1.5xIn
Max voltage overload (in bank)	1.15xUn
Insulating voltage (bank)	80kV
Temperature range (operation)	-15/+50°C
Temperature range (bank)	-1/+40°C
Discharge device	on each bank
Use	indoor
Service	continuous
Capacitors connection	delta
Operation devices	capacitors connection (ACB)
Total inrush losses	- 2W/kvar
Inner surface finish	zinc passivation
Standards (operation)	IEC 61001-1/2
Standards (bank)	IEC 61459-UL, IEC 61961

Part number	Power (kvar)		Banks (N=300V)	Steps	Discom factor (N)	KvAr (kA)	PFC Controller	Weights (kg)	Dimensions (mm (chapt. 7))		
	U <sub>in</sub> 415V	U <sub>in</sub> 400V							width	height	depth
KGAF01400000	14	12.8	1.8-8-7-3	7	85	50	SLGA	12	48	7	
KGAF20000000	28	25.6	3.6-7-3-2	5	85	50	SLGA	12	48	7	
KGAF20000001	28	25.6	1.8-3.6-3-2	11	85	50	SLGA	18	50	7	
KGAF20000002	28	25.6	3.6-7-3-14.4	7	85	50	SLGA	14	48	7	
KGAF20000003	30	27	1.8-3.6-7-2-14.4	16	85	50	SLGA	17	50	7	
KGAF22000000	32	28.8	2-7-2-14.4	4	100	50	SLGA	16	48	7	
KGAF22000001	32	30.4	3.6-7-2-14.4	8	100	50	SLGA	18	50	7	
KGAF22000002	36	32.4	1.8-3.6-3-14.4	18	100	50	SLGA	20	50	7	
KGAF24000000	44	39.6	3.6-7-2-14.4	11	125	50	SLGA	22	50	7	
KGAF24000001	44	40.8	3.6-7-3-14.4	13	125	50	SLGA	24	50	7	
KGAF24000002	48	44	3.6-7-3-14.4	15	125	50	SLGA	28	50	7	
KGAF27000000	54	48.6	7.2-14.4-3-14.4	9	150	50	SLGA	26	50	7	
FGAV30000000	60	54	7.2-14.4-3-14.4	10	200	5	SLGA	41	50	7	
FGAV31000000	112	102	7.2-14.4-3-14.4	14	200	5	SLGA	47	50	7	
FGAV32000000	128	115	7.2-14.4-3-14.4	17	400	5	SLGA	51	50	7	
FGAV33000000	144	130	14.4-14.4-3-14.4	10	400	5	SLGA	54	50	7	
FGAV34000000	160	145	14.4-14.4-3-14.4	13	400	5	SLGA	57	50	7	
FGAV35000000	180	162	14.4-14.4-3-14.4	15	800	5	SLGA	69	57	7	
FGAV36000000	240	216	14.4-14.4-3-14.4	18	800	5	SLGA	81	57	7	
FGAV37000000	270	243	14.4-14.4-3-14.4	17	800	25	SLGA	150	57	7	
FGAV38000000	300	270	14.4-14.4-3-14.4	10	800	25	SLGA	170	57	7	
FGAV39000000	400	360	14.4-14.4-3-14.4	10	800	30	SLGA	210	57	7	
FGAV40000000	480	432	14.4-14.4-3-14.4	10	1000	30	SLGA	250	57	7	
FGAV41000000	480	432	14.4-14.4-3-14.4	10	800	50	SLGA	180	72	7	
FGAV42000000	480	432	14.4-14.4-3-14.4	10	1000	50	SLGA	220	72	7	
FGAV43000000	540	486	14.4-14.4-3-14.4	10	1000	50	SLGA	270	72	7	
FGAV44000000	540	486	14.4-14.4-3-14.4	10	1000	50	SLGA	420	72	7	
FGAV45000000	720	675	14.4-14.4-3-14.4	10	1000	50	SLGA	420	72	7	
FGAV46000000	800	720	14.4-14.4-3-14.4	10	1000	50	SLGA	520	72	7	
FGAV47000000	800	720	14.4-14.4-3-14.4	10	1000	50	SLGA	580	72	7	
FGAV48000000	900	810	14.4-14.4-3-14.4	10	1000	50	SLGA	580	72	7	
FGAV49000000	1080	972	14.4-14.4-3-14.4	10	1000	50	SLGA	620	72	7	
FGAV51000000	1120	1008	14.4-14.4-3-14.4	10	1000	50	SLGA	680	72	7	







1. Maximum allowed value according to IEC 60311 art. 20-1.  
2. Maximal in the conditions of full rated capacitor production in practice.  
3. Other related upon request. The HP10 series and HP10max series are not available without option controlled by the capacitor connection device.  
4. Full power version under C&D E.P.S.

Part numbers and detailed technical features, divided by family device size and cutting in kvar







Other available versions with the same type of capacitor. Refer to the general catalog, or contact your Regional Sales Office

# Power factor correction solutions with standard or high gradient metallized polypropylene capacitors

## In this chapter you will find the following ranges

	<b>SP20</b>	Fix Power Factor Correction Systems with standard polypropylene film and 400V nominal voltage capacitors
	<b>RP10</b>	Fix Power Factor Correction Systems with standard polypropylene film and 460V nominal voltage capacitors
	<b>HP10</b>	Automatic Power Factor Correction Systems with high energy density polypropylene film and 415V nominal voltage capacitors
	<b>HP20</b>	Automatic Power Factor Correction Systems with high energy density polypropylene film and 460V nominal voltage capacitors
	<b>FH20</b>	Automatic and fix detuned Power Factor Correction Systems with 180Hz detuned reactors and high energy density polypropylene film and 550V nominal voltage capacitors .
	<b>FH30</b>	Automatic detuned Power Factor Correction Systems with 135Hz detuned reactors and high energy density polypropylene film and 550V nominal voltage capacitors.

## Other versions and ranges available (see the general catalog on [www.icar.com](http://www.icar.com))

	<b>RP20</b>	Fix Power Factor Correction Systems with standard polypropylene film and 460V nominal voltage capacitors
	<b>HP30</b>	Automatic Power Factor Correction Systems with high energy density polypropylene film and 550V nominal voltage capacitors
	<b>FH20/S</b>	Thyristor Switched Automatic detuned Power Factor Correction Systems with 180Hz detuned reactors and high energy density polypropylene film and 550V nominal voltage capacitors.
	<b>FH30/S</b>	Thyristor Switched Automatic detuned Power Factor Correction Systems with 135Hz detuned reactors and high energy density polypropylene film and 550V nominal voltage capacitors.
	<b>HP70</b>	660/690V Automatic Power Factor Correction Systems with high energy density polypropylene film and 900V nominal voltage capacitors
	<b>FH70</b>	660/690V Automatic and fix 180Hz detuned Power Factor Correction Systems with detuned reactors and high energy density polypropylene film and 900V nominal voltage capacitors

NB: see page 10 for standard and optional features.



# CRM25

**TECHNICAL CHARACTERISTICS:**

Rated operational voltage	U <sub>e</sub> =400-460-550V
Rated frequency	50Hz
Max current overload I <sub>n</sub>	1,3 I <sub>n</sub>
Max voltage overload V <sub>n</sub>	1.1xV <sub>n</sub>
Insulating voltage	3/15kV - U <sub>e</sub> ≤660Vac
Temperature range	-25/+55°C
Capacitance tolerance	-5÷+10%
Terminal voltage test	2.15xU <sub>N</sub> 10 sec.
Service	continuous
Capacitors connection	polypropylene
Standards	IEC 60831-1/2

**GENERALITIES:**

- Metallic case with protection degree IP00 (other on request)
- Internal overpressure protection system
- Resin or oil impregnation.

All parts inside these products are compliant with Safety Regulations.

Range	Part number	Model	Rated Voltage U <sub>N</sub> (V)	MAX Voltage U <sub>MAX</sub> (V)	Power (kvar)	Capacitance (μF)	DIM (mm)	Weight (kg)	Pcs/box
<b>SP20</b>	CRMT166163400C0	<b>CRM25-11C-1.66-400</b>	400	<b>440</b>	1,66	<b>33,3</b>	55x128	<b>0,4</b>	36
	CRMT208163400B0	<b>CRM25-11B-2.08-400</b>	400	<b>440</b>	2,08	<b>41,3</b>	55x128	<b>0,4</b>	36
	CRMT333163400A0	<b>CRM25-11A-3.33-400</b>	400	<b>440</b>	3,33	<b>66,6</b>	60x138	<b>0,5</b>	36
	CRMT416163400A0	<b>CRM25-11A-4.16-400</b>	400	<b>440</b>	4,16	<b>82,7</b>	60x138	<b>0,5</b>	36
<b>RP10</b>	CRMM166163400B0	<b>CRM25-11B-1.66-460</b>	460	<b>500</b>	1,66	<b>25</b>	55x128	<b>0,4</b>	36
	CRMM333163400B0	<b>CRM25-11B-3.33-460</b>	460	<b>500</b>	3,33	<b>50</b>	60x138	<b>0,5</b>	36
	CRMM372163400B0	<b>CRM25-11B-3.72-460</b>	460	<b>500</b>	3,72	<b>56</b>	60x138	<b>0,5</b>	36
<b>RP20</b>	CRMR166163300A0	<b>CRM25-11A-1.66-550</b>	550	<b>600</b>	1,66	<b>17,5</b>	45x128	<b>0,3</b>	50
	CRMR333163400A0	<b>CRM25-11A-3.33-550</b>	550	<b>600</b>	3,33	<b>35</b>	60x138	<b>0,5</b>	36



# CRM25



## TECHNICAL CHARACTERISTICS:

Rated operational voltage	U <sub>e</sub> =400-460-550V
Rated frequency	50Hz
Max current overload I <sub>n</sub>	1,3 I <sub>n</sub> (continuous) 2 I <sub>n</sub> (x 380s) 3 I <sub>n</sub> (x150s) 4 I <sub>n</sub> (x70s) 5 I <sub>n</sub> (x45s)
Max voltage overload V <sub>n</sub>	3xU <sub>n</sub> (x 1 minute)
Insulating voltage	3/15kV - U <sub>e</sub> ≤660Vac
Temperature range	-25/+55°C
Capacitance tolerance	-5÷+10%
Terminal voltage test	2.15xU <sub>N</sub> 10 sec.
Service	continuous
Capacitors connection	high gradient metallized polypropylene
Standards	IEC 60831-1/2

## GENERALITIES:

- Metallic case with protection degree IP00
- Internal overpressure protection system
- Oil impregnation vacuum packed.

All parts inside these products are compliant with Safety Regulations.

Range	Part number	Model	Rated Voltage U <sub>N</sub> (V)	MAX Voltage U <sub>MAX</sub> (V)	Power (kvar)	Capacitance (µF)	DIM (mm)	Weight (kg)	Pcs/box
HP10	CRMK69006320SB0	CRM-25-11A-0.69-415	415	456	0,69	12,2	55x78	0,25	36
	CRMK13816320SB0	CRM-25-11A-1.38-415	415	456	1,38	25,4	55x78	0,25	36
	CRMK275163400A0	CRM25-11A-2.75-415	415	456	2,75	50,8	60x138	0,5	36
	CRMK550163400A0	CRM25-11A-5.50-415	415	456	5,5	101,7	60x138	0,5	36
HP20	CRMM69006320SB0	CRM-25-11A-0.69-460	460	500	0,69	10,3	55x78	0,25	36
	CRMM13816320SB0	CRM-25-11A-1.38-460	460	500	1,38	20,6	55x78	0,25	36
	CRMM275163400A0	CRM25-11A-2.75-460	460	500	2,75	41,3	60x138	0,5	36
	CRMM550163400A0	CRM25-11A-5.50-460	460	500	5,5	82,7	60x138	0,5	36
HP30 FH20	CRMR13816320SB0	CRM25-11A-1.38-550	550	600	1,38	14,5	55x78	0,25	36
	CRMR275163400A0	CRM25-11A-2.75-550	550	600	2,75	28,9	60x138	0,5	36
	CRMR550163400A0	CRM25-11A-5.50-550	550	600	5,5	57,9	60x138	0,5	36

# SP20

U <sub>e</sub>	U <sub>N</sub>	U <sub>MAX</sub> <sup>1</sup>	f	THDI <sub>R</sub> %	THDI <sub>C</sub> % <sup>2</sup>
400V	400V	440V	50 Hz	≤7%	≤40%



SUPERriphaso



Riphaso



MICROfix

## TECHNICAL CHARACTERISTICS:

Rated operational voltage	U <sub>e</sub> =400V
Rated frequency	50Hz
Max current overload I <sub>n</sub>	1.3xI <sub>n</sub>
Max voltage overload V <sub>n</sub>	1.1xU <sub>n</sub>
Insulating voltage (SUPERriphaso, Riphaso)	3/15kV - U <sub>e</sub> ≤660Vac
Insulating voltage (MICROfix)	690V
Temperature range (capacitor bank)	-5/+40°C
Temperature range (capacitors)	-25/+55°C
Discharge device	on each bank
Use	indoor
Service	continuous
Capacitors connection	delta
Total Joule losses	~ 2W/kvar
Inner surface finish (MICROfix)	zinc passivation
Applicable standards	IEC 61439-1/2, IEC 61921
Capacitors standards	IEC 60831-1/2

	Part number	Power (kvar) U <sub>e</sub> =400V	Modules n°	Weight (kg)	Dimens. (see chapt 7)
<b>SUPERriphaso</b>	SRWT250150C1000	2,5	1	1	21
	SRWT500150C1000	5	1	1,7	21
	SRWT100250C1000	10	1	2,1	21
	SRWT150250C2000	15	2	3,8	22
	SRWT200250C2000	20	2	4,2	22
	SRWT250250C3000	25	3	5,9	23
	SRWT300250C3000	30	3	6,3	23
	SRWT400250C4000	40	4	8,4	24
	SRWT500250C5000	50	5	10,5	25

	Part number	Power (kvar) U <sub>e</sub> =400V	Weight (kg)	Dimens. (see chapt 7)
<b>Riphaso</b>	RPHT500150C0300	5	4,5	31
	RPHT100250C0300	10	5	31
	RPHT150250C0600	15	6	31
	RPHT200250C0600	20	6,5	31
	RPHT250250C0900	25	7,5	32
	RPHT300250C0900	30	8	32
	RPHT400250C1200	40	9,5	32
	RPHT500250C1500	50	11	32

	Part number	Power (kvar) U <sub>e</sub> =400V	LBS (A)	Weight (kg)	Dimens. (see chapt 7) <sup>3</sup>
<b>MICROfix</b>	FTPPF1500051A00	5	40	8	41
	FTPPF2100051A00	10	40	9	41
	FTPPF2150051A00	15	100	10	41
	FTPPF2200051A00	20	100	12	41
	FTPPF2250051A00	25	100	13	41
	FTPPF2300051A00	30	100	15	41
	FTPPF2400051A00	40	125	18	42
	FTPPF2500051A00	50	125	20	42
	FTPPF2600051A00	60	200	22	42

1. IEC /CEI 60831-1 max allowed value  
 2. Beyond this value harmonic amplification is likely  
 3. Available in IP55 enclosure as well (drawing 43).

### SUPERriphaso: GENERALITIES

- Plastic enclosure painted with epossidic dust paint, colour RAL7030, with protection degree IP40
- Single phase self-healing metallized polypropylene capacitors with U<sub>N</sub>=400V rated voltage.
- Discharge resistance.

All components inside this products are compliant with EU Safety Regulations.

### Riphaso: GENERALITIES

- Metallic enclosure painted with epossidic dust paint, colour RAL 7035 with IP3X protection degree
- Single phase self-healing metallized polypropylene capacitors with U<sub>N</sub>=400V rated voltage
- Discharge resistance.

All components inside this products are compliant with EU Safety Regulations.

### MICROfix: GENERALITIES

- Metallic enclosure internally and externally painted with epossidic dust paint, color RAL 7035
- Load-break switch with door interlock, designed at 1,495 I<sub>n</sub> according to IEC 60831-1 art.34
- N07V-K self-extinguish cable according to IEC 20/22-II and IEC 50627-2-1 standards
- IP 3X degree of protection
- Single phase self-healing metallized polypropylene capacitors with U<sub>N</sub>=400V rated voltage, capacitors equipped with discharge resistors
- Signal lamps power on.

All components inside this products are compliant with EU Safety Regulations.

U <sub>e</sub>	U <sub>N</sub>	U <sub>MAX</sub> <sup>1</sup>	f	THDI <sub>R</sub> %	THDI <sub>C</sub> % <sup>2</sup>
400-460V	460V	500V	50 Hz	≤15%	≤60%

### TECHNICAL CHARACTERISTICS:

Rated operational voltage	U <sub>e</sub> =400-460V
Rated frequency	50Hz
Max current overload I <sub>n</sub>	1.3xI <sub>n</sub>
Max voltage overload V <sub>n</sub>	1.1xU <sub>n</sub>
Insulating voltage (SUPERriphaso, Riphaso)	3/15kV - U <sub>e</sub> ≤660Vac
Insulating voltage (MICROfix)	690V
Temperature range (capacitor bank)	-5/+40°C
Temperature range (capacitors)	-25/+55°C
Discharge device	on each bank
Use	indoor
Service	continuous
Capacitors connection	delta
Total Joule losses	~ 2W/kvar
Inner surface finish (MICROfix)	zinc passivation
Applicable standards	IEC 61439-1/2, IEC 61921
Capacitors standards	IEC 60831-1/2



SUPERriphaso



Riphaso



MICROfix

	Part number	Power (kvar)		Modules n°	Weight (kg)	Dimens. (see chapt. 7)
		U <sub>e</sub> =460V	U <sub>e</sub> =400V			
SUPERriphaso	SRWM250150C1000	2,5	1,9	1	1	21
	SRWM500150C1000	5	3,8	1	1,7	21
	SRWM100250C1000	10	7,6	1	2,1	21
	SRWM150250C2000	15	11,4	2	3,8	22
	SRWM200250C2000	20	15,2	2	4,2	22
	SRWM250250C3000	25	19	3	5,9	23
	SRWM300250C3000	30	22,8	3	6,3	23
	SRWM400250C4000	40	30,4	4	8,4	24
	SRWM500250C5000	50	38	5	10,5	25

### SUPERriphaso: GENERALITIES

- Plastic enclosure painted with epossidic dust paint, colour RAL7030, with protection degree IP40
- Single phase self-healing metallized polypropylene capacitors with U<sub>N</sub>=460V rated voltage
- Discharge resistance.

All components inside this products are compliant with EU Safety Regulations.

	Part number	Power (kvar)		Weight (kg)	Dimens. (see chapt. 7)
		U <sub>e</sub> =460V	U <sub>e</sub> =400V		
Riphaso	RPHM500150C0300	5	3,8	4,5	31
	RPHM100250C0300	10	7,6	5	31
	RPHM150250C0600	15	11,4	6	31
	RPHM200250C0600	20	15,2	6,5	31
	RPHM250250C0900	25	19	7,5	32
	RPHM300250C0900	30	22,8	8	32
	RPHM400250C1200	40	30,4	9,5	32
	RPHM500250C1500	50	38	11	32

### Riphaso: GENERALITIES

- Metallic enclosure painted with epossidic dust paint, colour RAL 7035 with IP3X protection degree
- Single phase self-healing metallized polypropylene capacitors with U<sub>N</sub>=460V rated voltage
- Discharge resistance.

All components inside this products are compliant with EU Safety Regulations.

	Part number	Power (kvar)		LBS (A)	Weight (kg)	Dimens. (see chapt. 7) <sup>3</sup>
		U <sub>e</sub> =460V	U <sub>e</sub> =400V			
MICROfix	FTPLF1500051A00	5	3,8	40	8	41
	FTPLF2100051A00	10	7,6	40	9	41
	FTPLF2150051A00	15	11,4	40	10	41
	FTPLF2200051A00	20	15,2	40	12	41
	FTPLF2250051A00	25	19	100	13	41
	FTPLF2300051A00	30	22,8	100	15	41
	FTPLF2400051A00	40	30,4	125	18	42
	FTPLF2500051A00	50	38	125	20	42
	FTPLF2600051A00	60	45	125	22	42

### MICROfix: GENERALITIES

- Metallic enclosure internally and externally painted with epossidic dust paint, color RAL 7035
- Load-break switch with door interlock, designed at 1,495 I<sub>n</sub> according to IEC 60831-1 art.34.
- N07V-K self-extinguish cable according to IEC 20/22-II and IEC 50627-2-1 standards
- IP 3X degree of protection
- Single phase self-healing metallized polypropylene capacitors with U<sub>N</sub>=460V rated voltage, capacitors equipped with discharge resistors
- Signal lamps power on.

All components inside this products are compliant with EU Safety Regulations.

1. IEC /CEI 60831-1 max allowed value  
 2. Beyond this value harmonic amplification is likely  
 3. Available in IP55 enclosure as well (drawing 43).



# FD20

U <sub>e</sub>	U <sub>N</sub>	U <sub>MAX</sub> <sup>1</sup>	f	THDI <sub>R</sub> %	f <sub>N</sub>	THDV%
400V	550V	600V	50 Hz	≤60%	180 Hz	≤6%

100% NON LINEAR LOAD IN NETWORK



### TECHNICAL CHARACTERISTICS:

Rated operational voltage	U <sub>e</sub> =400V
Rated frequency	50Hz
Max current overload I <sub>n</sub>	1,3 I <sub>n</sub>
Max voltage overload V <sub>n</sub>	1.1xU <sub>e</sub>
Insulating voltage	3/15kV - U <sub>e</sub> ≤660Vac
Temperature range (capacitor bank)	-5/+40°C
Temperature range (capacitors)	25/+55°C
Discharge device	on each bank
Use	indoor
Capacitors connection	delta
Total Joule losses	~ 6W/kvar
Standards (capacitor bank)	IEC 61439-1/2, IEC 61921
Standards (capacitors)	IEC 60831-1/2

### Riphaso: GENERALITIES:

- Metallic enclosure internally and externally painted with epossidic dust paint, color RAL 7035.
- IP 3X degree of protection
- Single phase self-healing metallized paper capacitors with U<sub>N</sub>=460V rated voltage, capacitors equipped with discharge resistors
- Three phase harmonic blocking reactors, designed for 180Hz blocking frequency (p=7,7%).

All components inside this products are compliant with EU Safety Regulations.

Riphaso	Part number	Power (kvar) U <sub>e</sub> =400V	Weight (kg)	Dimens. (see chapt. 7)
	RPHT250252Z1200	25	32	33

<sup>1</sup> IEC 60831-1 max allowed value



U <sub>e</sub>	U <sub>N</sub>	U <sub>MAX</sub> <sup>1</sup>	f	THDI <sub>R</sub> %	THDI <sub>C</sub> % <sup>2</sup>
400-415V	415V	455V	50 Hz	≤12%	≤50%



### TECHNICAL CHARACTERISTICS:

Rated operational voltage	U <sub>e</sub> =400-415V
Rated frequency	50Hz
Max current overload I <sub>n</sub> (capacitors)	1,3xI <sub>n</sub> (continuous) 2xI <sub>n</sub> (x 380s) 3xI <sub>n</sub> (x 150s) 4xI <sub>n</sub> (x 70s) 5xI <sub>n</sub> (x 45s)
Max voltage overload V <sub>n</sub> (capacitors)	3xU <sub>n</sub> (x 1 minute)
Max current overload I <sub>n</sub> (bank)	1.3xI <sub>n</sub>
Max voltage overload V <sub>n</sub> (bank)	1.1xU <sub>e</sub>
Insulating voltage (bank)	690V
Temperature range (capacitors)	-25/+55°C
Temperature range (bank)	-5/+40°C
Discharge device	on each bank
Use	indoor
Service	continuous
Capacitors connection	delta
Operation devices	capacitors contactors (AC6b)
Total Joule losses	~ 2W/kvar
Inner surface finish	zinc passivation
Standards (capacitors)	IEC 60831-1/2
Standards (bank)	IEC 61439-1/2, IEC 61921

### GENERALITIES:

- Zink-passivated metallic enclosure painted with epossidic dust paint, colour RAL 7035
- Auxiliary transformer to separate power and auxiliary circuit parts (110V)
- Load-break switch with door interlock designed at 1,495\* I<sub>n</sub> as per IEC 60831-1 art.34
- Contactors with damping resistors to limit capacitors inrush current
- N07V-K self-extinguish cable according to IEC 20/22/II and IEC 50672-2-1 standards
- Microprocessor Power Factor Correction relay
- Single phase self-healing metallized polypropylene capacitor with U<sub>N</sub>=415V rated voltage.

All components inside this products are compliant with EU Safety.

	Part number	Power (kvar)		Banks U <sub>e</sub> =400V	Steps	Disconnector (A)	I <sub>cc</sub> <sup>3</sup> (kA)	PFC Controller	Weight (kg)	Dimensions (see chapt. 7)		
		U <sub>e</sub> =415V	U <sub>e</sub> =400V							IP3X	IP4X	IP55 <sup>4</sup>
MICROmatic	IC0AKF214050652	14	12,6	1.8-3.6-7.2	7	63	50	5LGA	12	49	/	/
	IC0AKF220050652	20	18	3.6-7.2-7.2	5	63	50	5LGA	13	49	/	/
	IC0AKF222050652	22	19,8	1.8-3.6-2x7.2	11	80	50	5LGA	16	50	/	/
	IC0AKF228050652	28	25,2	3.6-7.2-14.4	7	80	50	5LGA	14	49	/	/
	IC0AKF230050652	30	27	1.8-3.6-7.2-14.4	15	80	50	5LGA	17	50	/	/
	IC0AKF232050652	32	28,8	2x7.2-14.4	4	100	50	5LGA	16	49	/	/
	IC0AKF236050652	36	32,4	3.6-2x7.2-14.4	9	100	50	5LGA	18	50	/	/
	IC0AKF238050652	38	34,2	1.8-3.6-2x7.2-14.4	19	100	50	5LGA	20	50	/	/
	IC0AKF244050652	44	39,6	3.6-7.2-2x14.4	11	125	50	5LGA	22	50	/	/
	IC0AKF252050652	52	46,8	3.6-2x7.2-2x14.4	13	125	50	5LGA	24	50	/	/
MINImatic	IC0AKF260050652	60	54	3.6-7.2-3x14.4	15	125	50	5LGA	26	50	/	/
	IC0AKF272050652	72	64,8	7.2-2x14.4-28.8	9	160	50	5LGA	28	50	/	/
	IF0AKF280050652	80	75	7.5-15-22.5-30	10	250	9	5LGA	41	55	/	59
	IF0AKF311250652	112	105	7.5-15-22.5-2x30	14	250	9	5LGA	47	56	/	59
	IF0AKF313650652	136	125	7.5-15-22.5-30-52.5	17	400	9	5LGA	51	56	/	59
	IF0AKF316050652	160	150	15-30-45-60	10	400	9	5LGA	54	56	/	59
	IF0AKF319250652	192	180	15-30-60-75	12	400	9	5LGA	60	57	/	60
	IF0AKF321650652	216	200	15-30-60-90	13	500	9	5LGA	65	57	/	60
	IF0AKF324050652	240	225	15-30-60-120	15	500	9	5LGA	69	57	/	60
	IF0AKF327550884	275	255	15-2x30-3x60	17	630	25	8LGA	150	64	/	/
MIDImatic	IL0FKF332050884	320	300	2x30-4x60	10	800	30	8LGA	170	64	/	/
	IL0FKF340050884	400	375	2x38-4x75	10	800	30	8LGA	210	64	/	/
	IL0FKF348050884	480	450	2x45-4x90	10	1000	30	8LGA	250	64	/	/
	IN0AKF332050700	320	300	2x30-4x60	10	800	50	8BGA	190	/	72	75
MULTImatic	IN0AKF340050700	400	375	2x37.5-4x75	10	1250	50	8BGA	210	/	72	75
	IN0AKF348050700	480	450	2x45-4x90	10	1250	50	8BGA	230	/	72	75
	IN0AKF356050700	560	525	2x52.5-4x105	10	1250	50	8BGA	270	/	74	81
	IN0AKF364050700	640	600	2x60-4x120	10	2x800	50	8BGA	420	/	92	83
	IN0AKF372050700	720	675	2x67.5-4x135	10	2x1250	50	8BGA	500	/	92	83
	IN0AKF380050700	800	750	2x75-4x150	10	2x1250	50	8BGA	520	/	92	83
	IN0AKF388050700	880	825	2x82.5-4x165	10	2x1250	50	8BGA	560	/	92	83
	IN0AKF396050700	960	900	2x90-4x180	10	2x1250	50	8BGA	580	/	92	83
	IN0AKF410450700	1040	975	2x97.5-4x195	10	2x1250	50	8BGA	620	/	94	85
	IN0AKF411250700	1120	1050	2x105-4x210	10	2x1250	50	8BGA	660	/	94	85

1. Maximum allowed value according to IEC 60831-1 art. 20.1

2. Attention: in this conditions of load network harmonic amplification phenomena is possible

3. Other values upon request. For MICROmatic and MIDImatic series short-circuit withstand current conditioned by the upstream protective device

4. For part numbers contact ICAR S.p.A.



# HP20

U <sub>e</sub>	U <sub>N</sub>	U <sub>MAX</sub> <sup>1</sup>	f	THDI <sub>R</sub> %	THDI <sub>C</sub> % <sup>2</sup>
400-415V	460V	500V	50 Hz	≤20%	≤70%



### TECHNICAL CHARACTERISTICS:

Rated operational voltage	U <sub>e</sub> =400-415V
Rated frequency	50Hz
Max current overload I <sub>n</sub> (capacitors)	1,3xI <sub>n</sub> (continous) 2xI <sub>n</sub> (x 380s) 3xI <sub>n</sub> (x 150s) 4xI <sub>n</sub> (x 70s) 5xI <sub>n</sub> (x 45s)
Max voltage overload V <sub>n</sub> (capacitors)	3xU <sub>n</sub> (x 1 minute)
Max current overload I <sub>n</sub> (bank)	1.3xI <sub>n</sub>
Max voltage overload V <sub>n</sub> (bank)	1.1xU <sub>e</sub>
Insulating voltage (bank)	690V
Temperature range (capacitors)	-25/+55°C
Temperature range (bank)	-5/+40°C
Discharge device	on each bank
Use	indoor
Service	continous
Capacitors connection	delta
Operation devices	capacitors contactors( AC6b)
Total Joule losses	~ 2W/kvar
Inner surface finish	zinc passivation
Standards (capacitors)	IEC 60831-1/2
Standards (bank)	IEC 61439-1/2, IEC 61921

### GENERALITIES:

- Zink-passivated metallic enclosure painted with epossidic dust paint, colour RAL 7035
- Auxiliary transformer to separate power and auxiliary circuit parts (110V)
- Load-break switch with door interlock, designed at 1,495\* I<sub>n</sub> as per IEC 60831-1/34
- Contactors with damping resistors to limit capacitors' inrush current (AC6b)
- N07V-K self-extinguish cable according to IEC 20/22/II and IEC 501027-2-1 standards
- Microprocessor Power Factor Correction relay
- Single phase self-healing metallized polypropylene capacitor with U<sub>N</sub>=460V rated voltage.

All components inside this products are compliant with EU Safety Regulations.

	Part number	Power (kvar)			Banks U <sub>e</sub> =400V	Steps	Discon- nector (A)	I <sub>cc</sub> <sup>3</sup> (kA)	PFC Controller	Weight (kg)	Dimensions (see chapt. 7)		
		U <sub>N</sub> =460V	U <sub>e</sub> =415V	U <sub>e</sub> =400V							IP3X	IP4X	IP55 <sup>4</sup>
MICROmatic	IC0JLF214050652	14	11	10,5	1,5-3-6	7	63	50	5LGA	12	49	/	/
	IC0JLF220050652	20	16	15	3-2x6	5	63	50	5LGA	13	49	/	/
	IC0JLF222050652	22	18	16,5	1,5-3-2x6	11	80	50	5LGA	16	50	/	/
	IC0JLF228050652	28	22	21	3-6-12	7	63	50	5LGA	14	49	/	/
	IC0JLF230050652	30	24	22,5	1,5-3-6-12	15	80	50	5LGA	17	50	/	/
	IC0JLF232050652	32	25,6	24	2x6-12	4	80	50	5LGA	16	50	/	/
	IC0JLF236050652	36	29	27	3-2x6-12	9	80	50	5LGA	18	50	/	/
	IC0JLF238050652	38	31	28,5	1,5-3-2x6-12	19	100	50	5LGA	20	50	/	/
	IC0JLF244050652	44	36	33	3-6-2x12	11	100	50	5LGA	22	50	/	/
	IC0JLF252050652	52	42	39	3-2x6-2x12	13	100	50	5LGA	24	50	/	/
MINImatic	IC0JLF260050652	60	49	45	3-6-3x12	15	125	50	5LGA	26	50	/	/
	IC0JLF272050652	72	58	54	6-4x12	9	250	50	5LGA	29	50	/	/
	IF0JLF280050652	80	65	60	6-12-18-24	10	250	9	5LGA	41	55	/	59
	IF0JLF311250652	112	91	84	6-12-18-2x24	14	250	9	5LGA	47	56	/	59
	IF0JLF313650652	136	110	102	6-12-18-24-42	17	250	9	5LGA	51	56	/	59
	IF0JLF316050652	160	130	120	12-24-36-48	10	400	9	5LGA	54	56	/	59
	IF0JLF319250652	192	155	144	12-24-48-60	12	400	9	5LGA	60	57	/	60
	IF0JLF321650652	216	168	156	12-24-48-72	13	400	9	5LGA	65	57	/	60
	IF0JLF324050652	240	194	180	12-24-48-96	15	400	9	5LGA	69	57	/	60
	IF0JLF327250652	272	220	204	24-2x48-84	8	500	9	5LGA	74	58	/	61
MIDImatic	IL0ULF332050884	320	259	240	2x24-4x48	10	630	25	8LGA	230	64	/	/
	IL0ULF340050884	400	324	300	2x30-4x60	10	800	30	8LGA	255	64	/	/
	IL0ULF348050884	480	389	360	2x36-4x72	10	800	30	8LGA	275	64	/	/
MULTImatic	INONLF332050700	320	259	240	2x24-4x48	10	630	25	8BGA	252	/	72	75
	INONLF340050700	400	324	300	2x30-4x60	10	800	50	8BGA	274	/	72	75
	INONLF348050700	480	389	360	2x36-4x72	10	800	50	8BGA	300	/	72	75
	INONLF356050700	560	454	420	2x42-4x84	10	1250	50	8BGA	320	/	74	81
	INONLF364050700	640	518	480	2x48-4x96	10	1250	50	8BGA	340	/	74	81
	INONLF372050700	720	583	540	2x54-4x108	10	1250	50	8BGA	526	/	70	73
	INONLF380050700	800	648	600	2x60-4x120	10	2x800	50	8BGA	552	/	92	83
	INONLF388050700	880	713	660	2x66-4x132	10	2x800	50	8BGA	574	/	92	83
	INONLF396050700	960	778	720	2x72-4x144	10	2x800	50	8BGA	600	/	92	83
	INONLF410450700	1040	842	780	2x78-4x156	10	2x1250	50	8BGA	620	/	94	85
	INONLF411250700	1120	907	840	2x84-4x168	10	2x1250	50	8BGA	640	/	94	85
	INONLF412050700	1200	972	900	2x90-4x180	10	2x1250	50	8BGA	670	/	94	85
	INONLF412850700	1280	1037	960	2x96-4x192	10	2x1250	50	8BGA	690	/	94	85
	INONLF413650700	1360	1102	1020	2x102-4x204	10	2x1250	50	8BGA	710	/	90	93
INONLF414450700	1440	1166	1080	2x108-4x216	10	2x1250	50	8BGA	730	/	90	93	

1. Maximum allowed value according to IEC 60831-1 art. 20.1

2. Attention: in this conditions of load network harmonic amplification phenomena is possible

3. Other values upon request. For MICROmatic and MIDImatic series short-circuit withstand current conditioned by the upstream protective device

4. For part numbers contact ICAR S.p.A.



# FH20

U <sub>e</sub>	U <sub>N</sub>	U <sub>MAX</sub> <sup>1</sup>	f	THD <sub>I</sub> R%	f <sub>N</sub>	THD <sub>V</sub> %
400-415V	550V	600V	50 Hz	≤60%	180 Hz	≤6%

100% NON LINEAR LOAD IN NETWORK



### TECHNICAL CHARACTERISTICS:

Rated operational voltage	U <sub>e</sub> =400-415V
Rated frequency	50Hz
Max current overload I <sub>n</sub> (capacitors)	1,3xI <sub>n</sub> (continuous) 2xI <sub>n</sub> (x 380s) 3xI <sub>n</sub> (x 150s) 4xI <sub>n</sub> (x 70s) 5xI <sub>n</sub> (x 45s)
Max voltage overload V <sub>n</sub> (capacitors)	3xU <sub>n</sub> (x 1 minute)
Max current overload I <sub>n</sub> (bank)	1.3xI <sub>n</sub>
Max voltage overload V <sub>n</sub> (bank)	1.1xU <sub>e</sub>
Insulating voltage (bank)	690V
Temperature range (capacitors)	-25/+55°C
Temperature range (bank)	-5/+40°C
Discharge device	on each bank
Use	indoor
Service	continuous
Capacitors connection	delta
Operation devices	capacitors
Total Joule losses	~ 6W/kvar
Inner surface finish	zinc passivation
Standards (capacitors)	IEC 60831-1/2
Standards (bank)	IEC 61439-1/2, IEC 61921

### GENERALITIES:

- Zink-passivated metallic enclosure painted with epossidic dust paint, colour RAL 7035
- Auxiliary transformer to separate power and auxiliary circuit parts (110V)
- Load-break switch with door interlock, designed at 1,495\* I<sub>n</sub> as per IEC 60831-1 art.34
- Contactors
- N07V-K self-extinguish cable according to IEC 20/22/II and IEC 50627-2-1 standards
- Microprocessor Power Factor Correction relay
- Control and protection multimeter MCP5 (on MULTImatic cabinets only), integrated in 8BGA controller
- Single phase self-healing metallized polypropylene capacitors with U<sub>N</sub>= 550V rated voltage
- Three phase detuning choke with tuning frequency 180Hz (7,7%).

All components inside this products are compliant with EU Safety Regulations.

	Part number	Power (kvar)		Steps	Banks U <sub>e</sub> =400V	Disconnector (A)	Icc <sup>2</sup> (kA)	PFC Controller	Weight (kg)	Dimensions (see chapt. 7)		
		U <sub>e</sub> =415V	U <sub>e</sub> =400V							IP3X	IP4X	IP55 <sup>3</sup>
MINImatic	IF7AFF210050662	11	10	4	2x2.5-5	125	9	5LGA	41	56	/	59
	IF7AFF220050662	21	20	8	2x2.5-5-10	125	9	5LGA	47	56	/	59
	IF7AFF230050662	31	30	6	2x5-2x10	125	9	5LGA	57	56	/	59
	IF7AFF240050662	42	40	8	2x5-10-20	125	9	5LGA	74	57	/	60
	IF7AFF250050662	52	50	10	2x5-2x10-20	125	9	5LGA	78	57	/	60
	IF7AFF260050662	62	60	6	2x10-2x20	250	9	5LGA	100	57	/	60
	IF7AFF270050662	73	70	7	10-3x20	250	9	5LGA	112	58	/	61
MIDI matic	IF7AFF280050662	83	80	8	2x10-3x20	250	9	5LGA	126	58	/	61
	IL4FFF311050892	116	110	11	10-20-2x40	250	15	8BGA + MCP5	220	64	/	/
	IL4FFF315050892	158	150	15	10-20-3x40	400	20	8BGA + MCP5	260	64	/	/
	IL4FFF318050892	194	180	9	20-2x40-80	400	20	8BGA + MCP5	285	64	/	/
	IL4FFF322050892	235	220	11	20-40-2x80	630	20	8BGA + MCP5	320	64	/	/
MULTImatic	IN7AFF310050701	107	100	5	20-2x40	250	17	8BGA + MCP5	220	/	72	75
	IN7AFF314050701	150	140	7	20-40-80	400	25	8BGA + MCP5	260	/	72	75
	IN7AFF318050701	194	180	9	20-2x40-80	400	25	8BGA + MCP5	300	/	72	75
	IN7AFF322050701	235	220	11	20-40-2x80	630	25	8BGA + MCP5	325	/	72	75
	IN7AFF326050701	278	260	13	20-2x40-2x80	630	25	8BGA + MCP5	365	/	74	82
	IN7AFF330050701	321	300	15	20-40-3x80	800	50	8BGA + MCP5	385	/	74	82
	IN7AFF334050701	364	340	17	20-2x40-3x80	800	50	8BGA + MCP5	415	/	70	76
	IN7AFF338050701	407	380	19	20-40-4x80	1250	50	8BGA + MCP5	445	/	70	76
	IN7AFF342050701	450	420	21	20-2x40-2x80-160	1250	50	8BGA + MCP5	475	/	71	77
	IN7AFF346050701	492	460	23	20-40-3x80-1x160	1250	50	8BGA + MCP5	505	/	71	77
	IN7AFF350050701	535	500	25	20-2x40-80-2x160	2x630	25	8BGA + MCP5	775	/	94	86
	IN7AFF356050701	600	560	7	80-3x160	2x800	50	8BGA + MCP5	800	/	94	86
	IN7AFF364050701	685	640	8	2x80-3x160	2x800	50	8BGA + MCP5	860	/	94	86
	IN7AFF372050701	770	720	9	80-4x160	2x1250	50	8BGA + MCP5	920	/	90	96
	IN7AFF380050701	856	800	10	2x80-4x160	2x1250	50	8BGA + MCP5	980	/	90	96
IN7AFF388050701	942	880	11	80-5x160	2x1250	50	8BGA + MCP5	1040	/	91	95	
IN7AFF396050701	1027	960	12	2x80-3x160-1x320	2x1250	50	8BGA + MCP5	1100	/	91	95	

1. Maximum allowed value according to CEI EN 60831-1 art. 20.1

2. This other values upon request. For MIDImatic short-circuit withstand current conditioned by the upstream protective device.

3. For part numbers contact ICAR Spa

### Other available versions

**FH20/S:** Thyristor switched and detuned capacitor banks, for fast changing loads. Available in MULTImatic only.



# FH30



MINImatic



MULTImatic

### GENERALITIES:

- Zink-passivated metallic enclosure painted with epossidic dust paint, colour RAL 7035
- Auxiliary transformer to separate power and auxiliary circuit parts (110V)
- Load-break switch with door interlock, designed at  $1,495 \cdot I_n$  as per IEC 60831-1/34
- Contactors
- N07V-K self-extinguish cable according to IEC 20/22/II and IEC 501027-2-1 standards
- Microprocessor Power Factor Correction relay
- Control and protection multimeter MCP5, integrated in 8BGA controller
- Single phase self-healing metallized polypropylene capacitor with  $U_N=550V$  rated voltage
- Three phase detuning choke with tuning frequency 180Hz (7,7%). All components inside this products are compliant with EU Safety Regulations.

U <sub>e</sub>	U <sub>N</sub>	U <sub>MAX</sub> <sup>1</sup>	f	THDI <sub>R</sub> %	f <sub>N</sub>	THDV <sub>R</sub> %
400-415V	550V	600V	50 Hz	100%	180 Hz	≤6%

### TECHNICAL CHARACTERISTICS:

Rated operational voltage	U <sub>e</sub> =400-415V
Rated frequency	50Hz
Max current overload I <sub>n</sub> (capacitors)	1,3xI <sub>n</sub> (continous) 2xI <sub>n</sub> (x 380s) 3xI <sub>n</sub> (x 150s) 4xI <sub>n</sub> (x 70s) 5xI <sub>n</sub> (x 45s)
Max voltage overload V <sub>n</sub> (capacitors)	3xU <sub>n</sub> (x 1 minute)
Max current overload I <sub>n</sub> (bank)	1.3xI <sub>n</sub>
Max voltage overload V <sub>n</sub> (bank)	1.1xU <sub>e</sub>
Insulating voltage (bank)	690V
Temperature range (capacitors)	-25/+55°C
Temperature range (bank)	-5/+40°C
Discharge device	on each bank
Use	indoor
Service	continous
Capacitors connection	delta
Operation devices	capacitors
Total Joule losses	~ 8W/kvar
Inner surface finish	zinc passivation
Standards (capacitors)	IEC 60831-1/2
Standards (bank)	IEC 61439-1/2, IEC 61921

	Part number	Power (kvar)		Banks U <sub>e</sub> =400V	Steps	Discon- nector (A)	I <sub>cc</sub> <sup>2</sup> (kA)	PFC Controller	Weight (kg)	Dimensions (see chapt. 7)		
		U <sub>e</sub> =415V	U <sub>e</sub> =400V							IP3X	IP4X	IP55 <sup>3</sup>
MINImatic	IF7JFF210050671	11	10	2x2.5-5	4	125	9	5LGA	41	56	/	59
	IF7JFF220050671	21	20	2x2.5-5-10	8	125	9	5LGA	47	56	/	59
	IF7JFF230050671	31	30	2x5-2x10	6	125	9	5LGA	57	56	/	59
	IF7JFF240050671	42	40	2x5-10-20	8	125	9	5LGA	74	57	/	60
	IF7JFF250050671	52	50	2x5-2x10-20	10	250	9	5LGA	78	58	/	61
	IF7JFF260050671	62	60	2x10-2x20	6	250	9	5LGA	100	58	/	61
	IF7JFF270050671	73	70	10-3x20	7	250	9	5LGA	112	58	/	61
MULTImatic	IN7JFF310050702	107	100	20-2x40	5	250	17	8BGA + MCP5	220	/	72	75
	IN7JFF314050702	150	140	20-40-80	7	400	25	8BGA + MCP5	260	/	72	75
	IN7JFF318050702	194	180	20-2x40-80	9	400	25	8BGA + MCP5	300	/	72	75
	IN7JFF322050702	235	220	20-40-2x80	11	630	25	8BGA + MCP5	325	/	72	75
	IN7JFF326050702	278	260	20-2x40-2x80	13	630	25	8BGA + MCP5	365	/	74	82
	IN7JFF330050702	321	300	20-40-3x80	15	800	50	8BGA + MCP5	385	/	74	82
	IN7JFF334050702	364	340	20-2x40-3x80	17	800	50	8BGA + MCP5	415	/	70	76
	IN7JFF338050702	407	380	20-40-4x80	19	1250	50	8BGA + MCP5	445	/	70	76
	IN7JFF342050702	450	420	20-2x40-2x80-160	21	1250	50	8BGA + MCP5	475	/	71	77
	IN7JFF346050702	492	460	20-40-3x80-1x160	23	1250	50	8BGA + MCP5	505	/	71	77
	IN7JFF350050702	535	500	20-2x40-80-2x160	25	2x630	25	8BGA + MCP5	775	/	94	86
	IN7JFF356050702	600	560	80-3x160	7	2x800	50	8BGA + MCP5	800	/	94	86
	IN7JFF364050702	685	640	2x80-3x160	8	2x800	50	8BGA + MCP5	860	/	94	86
	IN7JFF372050702	770	720	80-4x160	9	2x1250	50	8BGA + MCP5	920	/	90	96
	IN7JFF380050702	856	800	2x80-4x160	10	2x1250	50	8BGA + MCP5	980	/	90	96
	IN7JFF388050702	942	880	80-5x160	11	2x1250	50	8BGA + MCP5	1040	/	91	95
	IN7JFF396050702	1027	960	2x80-3x160-1x320	12	2x1250	50	8BGA + MCP5	1100	/	91	95

1. Maximum allowed value according to IEC 60831-1 art. 20.1

2. This other values upon request

3. For part numbers contact ICAR S.p.A.

### Other available versions

**FH30/S:** Thyristor switched and detuned capacitor banks, for fast changing loads. Available in MULTImatic only.

U <sub>e</sub>	U <sub>N</sub>	U <sub>MAX</sub> <sup>1</sup>	f	THDI <sub>R</sub> %	THDI <sub>C</sub> % <sup>2</sup>
400-415V	415V	455V	50 Hz	≤12%	≤50%



MICRO rack



MINI rack



MULTI rack

### TECHNICAL CHARACTERISTICS:

Rated operational voltage	U <sub>e</sub> =400-415V
Rated frequency	50Hz
Max current overload I <sub>n</sub> (capacitors)	1,3xI <sub>n</sub> (continuous) 2xI <sub>n</sub> (x 380s) 3xI <sub>n</sub> (x 150s) 4xI <sub>n</sub> (x 70s) 5xI <sub>n</sub> (x 45s)
Max voltage overload V <sub>n</sub> (capacitors)	3xU <sub>n</sub> (x 1 minute)
Max current overload I <sub>n</sub> (tray)	1.3xI <sub>n</sub>
Max voltage overload V <sub>n</sub> (tray)	1.1xU <sub>e</sub>
Insulating voltage (tray)	690V
Temperature range (capacitors)	-25/+55°C
Discharge device	on each bank
Use	indoor
Service	continuous
Capacitors connection	delta
Operation devices	contactors for capacitors (AC6b)
Total Joule losses	~ 2W/kvar
Inner surface finish	zinc passivation
Standards (capacitors)	IEC 60831-1/2
Standards (tray)	IEC 61439-1/2, IEC 61921

### GENERALITIES:

- Contactors with damping resistors to limit capacitors' inrush current
- N07V-K self-extinguish cable according to IEC 20/22/II and IEC 50627-2-1 standards
- Three-phase fuse holder type NH00
- Power fuses NH00-gG
- Single phase self-healing metallized polypropylene capacitors with U<sub>N</sub>=415V rated voltage
- Discharge devices

All components inside this products are compliant with EU Safety Regulations.

MULTI-rack trays can also be used on MIDImatic systems from the PFCS production date 1st of June, 2016.

	Part number	Power (kvar)		Banks U <sub>e</sub> =400V	Weight (kg)	Dim (see chapt. 7) IP00
		U <sub>e</sub> =415V	U <sub>e</sub> =400V			
MICRO rack	IC1DKK120050000	2	1,8	1,8	1,7	108
	IC1DKK140050000	4	3,6	3,6	2	108
	IC1DKK180050000	8	7,2	7,2	2	108
	IC1DKK216050000	16	14,4	14,4	2,3	108
MINI rack	IW0AKK216050000	16	15	15	4	110
	IW0AKK232050000	32	30	30	6	110
	IW0AKK256050000	56	52,5	22.5-30	11	110
	IW0AKK280050268	80	75	15-30-30	13	110
	IW0AKK280050000	80	75	7.5-15-22.5-30	14	110
MULTI rack	IX0AKK280050000	80	75	2x7.5-4x15	19	120
	IX0AKK316050000	160	150	2x15-4x30	27	120

1. Maximum allowed value according to CEI EN 60831-1 art. 20.1

2. Attention: in this conditions of load network harmonic amplification phenomena is possible

U <sub>e</sub>	U <sub>N</sub>	U <sub>MAX</sub> <sup>1</sup>	f	THDI <sub>R</sub> %	THDI <sub>C</sub> % <sup>2</sup>
400-415V	460V	500V	50 Hz	≤20%	≤70%



MICRO  
rack



MINI  
rack



MULTI  
rack

## TECHNICAL CHARACTERISTICS:

Rated operational voltage	U <sub>e</sub> =400-415V
Rated frequency	50Hz
Max current overload I <sub>n</sub> (capacitors)	1,3xI <sub>n</sub> (continous) 2xI <sub>n</sub> (x 380s) 3xI <sub>n</sub> (x 150s) 4xI <sub>n</sub> (x 70s) 5xI <sub>n</sub> (x 45s)
Max voltage overload V <sub>n</sub> (capacitors)	3xU <sub>n</sub> (x 1 minute)
Max current overload I <sub>n</sub> (tray)	1.3xI <sub>n</sub>
Max voltage overload V <sub>n</sub> (tray)	1.1xU <sub>e</sub>
Insulating voltage (tray)	690V
Temperature range (capacitors)	-25/+55°C
Discharge device	on each bank
Use	indoor
Service	continous
Capacitors connection	delta
Operation devices	contactors for capacitors (AC6b)
Total Joule losses	~ 2W/kvar
Inner surface finish	zinc passivation
Standards (capacitors)	IEC 60831-1/2
Standards (tray)	IEC 61439-1/2, IEC 61921

## GENERALITIES:

- Contactors with damping resistors to limit capacitors' inrush current
- N07V-K self-extinguish cable according to IEC 20/22/II and IEC 50627-2-1 standards
- Three-phase fuse holder type NH00
- Power fuses NH00-gG
- Single phase self-healing metallized polypropylene capacitors with U<sub>N</sub>=460V rated voltage
- Discharge devices.

All components inside this products are compliant with EU Safety Regulations.

MULTI-rack trays can also be used on MIDImatic systems from the PFCS production date 1st of June, 2016.

	Part number	Power (kvar)			Banks U <sub>e</sub> =400V	Weight (kg)	Dim (see chapt. 7) IP00
		U <sub>e</sub> =460V	U <sub>e</sub> =415V	U <sub>e</sub> =400V			
MICRO rack	IC1DLK120050000	2	1,6	1,5	1,5	1,7	108
	IC1DLK140050000	4	3,2	3	3	2	108
	IC1DLK180050000	8	6,5	6	6	2	108
	IC1DLK216050000	16	13	12	12	2,3	108
MINI rack	IW0JLK216050000	16	13	12	12	4	110
	IW0JLK232050000	32	26	24	24	6	110
	IW0JLK256050000	56	45	42	18-24	11	110
	IW0JLK280050268	80	65	60	12-2x24	13	110
	IW0JLK280050000	80	65	60	6-12-18-24	14	110
MULTI rack	IX0NLK280050000	80	65	60	2x6-4x12	19	120
	IX0NLK316050000	160	129	120	2x12-4x24	27	120

1. Maximum allowed value according to CEI EN 60831-1 art. 20.1

2. Attention: in this conditions of load network harmonic amplification phenomena is possible

U <sub>e</sub>	U <sub>N</sub>	U <sub>MAX</sub> <sup>1</sup>	f	THDI <sub>R</sub> %	f <sub>N</sub>	THDV%
400-415V	550V	600V	50 Hz	≤60%	180 Hz	≤6%



MINI rack



MULTI rack

### TECHNICAL CHARACTERISTICS:

Rated operational voltage	U <sub>e</sub> =400-415V
Rated frequency	50Hz
Max current overload I <sub>n</sub> (capacitors)	1,3xI <sub>n</sub> (continuous) 2xI <sub>n</sub> (x 380s) 3xI <sub>n</sub> (x 150s) 4xI <sub>n</sub> (x 70s) 5xI <sub>n</sub> (x 45s)
Max voltage overload V <sub>n</sub> (capacitors)	3xU <sub>n</sub> (x 1 minute)
Max current overload I <sub>n</sub> (tray)	1.3xI <sub>n</sub>
Max voltage overload V <sub>n</sub> (tray)	1.1xU <sub>e</sub>
Insulating voltage (tray)	690V
Temperature range (capacitors)	-25/+55°C
Discharge device	on each bank
Use	indoor
Service	continuous
Capacitors connection	delta
Operation devices	contactors
Total Joule losses	~ 6W/kvar
Inner surface finish	zinc passivation
Standards (capacitors)	IEC 60831-1/2
Standards	IEC 61439-1/2, IEC 61921

### GENERALITIES:

- Contactors
- N07V-K self-extinguish cable according to IEC 20/22/II and IEC 50627-2-1 standards
- Three-phase fuse holder type NH00
- Power fuses NH00-gG
- Single phase self-healing metallized polypropylene capacitors with U<sub>N</sub>=550V rated voltage
- Discharge devices
- Three phase detuning choke with tuning frequency 180Hz (p=7,7%).

All components inside this products are compliant with EU Safety Regulations.

MULTI-rack trays can also be used on MIDmatic systems from the PFCS production date 1st of June, 2016.

	Part number	Power (kvar)		Banks U <sub>e</sub> =400V	Weight (kg)	Dim (see chapt. 7) IP00
		U <sub>e</sub> =415V	U <sub>e</sub> =400V			
MINI rack Filter	IW7TFK155050010	5,5	5	2x2.5	14	135
	IW7TFK210050274	11	10	2x5	19	135
	IW7TFK210050010	11	10	10	15	135
	IW7TFK215050010	16	15	5-10	22	135
	IW7TFK220050248	21	20	2x10	24	135
	IW7TFK220050010	21	20	20	20	135
MULTI rack Filter	IX7TFF220050010	21	20	20	25	130
	IX7TFF240050010	42	40	40	38	130
	IX7TFF260050010	63	60	20-40	63	130
	IX7TFF280050010	84	80	80	54	130

1. Maximum allowed value according to CEI EN 60831-1 art. 20.1

### Other available versions

**FH20/S:** Thyristor switched and detuned capacitor banks, for fast changing loads. Available in MULTImatic only.

U <sub>e</sub>	U <sub>N</sub>	U <sub>MAX</sub> <sup>1</sup>	f	THDI <sub>R</sub> %	f <sub>N</sub>	THDV <sub>R</sub> %
400-415V	550V	600V	50 Hz	100%	135 Hz	≤6%



MINI  
rack



MULTI  
rack

## TECHNICAL CHARACTERISTICS:

Rated operational voltage	U <sub>e</sub> =400-415V
Rated frequency	50Hz
Max current overload I <sub>n</sub> (capacitors)	1,3xI <sub>n</sub> (continuous) 2xI <sub>n</sub> (x 380s) 3xI <sub>n</sub> (x 150s) 4xI <sub>n</sub> (x 70s) 5xI <sub>n</sub> (x 45s)
Max voltage overload V <sub>n</sub> (capacitors)	3xU <sub>n</sub> (x 1 minute)
Max current overload I <sub>n</sub> (tray)	1.3xI <sub>n</sub>
Max voltage overload V <sub>n</sub> (tray)	1.1xU <sub>e</sub>
Insulating voltage (tray)	690V
Temperature range (capacitors)	-25/+55°C
Discharge device	on each bank
Use	indoor
Service	continuous
Capacitors connection	delta
Operation devices	contactors
Total Joule losses	~ 8W/kvar
Inner surface finish	zinc passivation
Standards (capacitors)	IEC 60831-1/2
Standards	IEC 61439-1/2, IEC 61921

## GENERALITIES:

- Contactors
- N07V-K self-extinguish cable according to IEC 20/22/II and IEC 50627-2-1 standards
- Three-phase fuse holder type NH00
- Power fuses NH00-gG
- Single phase self-healing metallized polypropylene capacitors with U<sub>N</sub>=550V rated voltage
- Discharge devices
- Three phase detuning choke with tuning frequency 135Hz.

All components inside this products are compliant with EU Safety Regulations.

MULTI-rack trays can also be used on MIDimatic systems from the PFCS production date 1st of June, 2016.

	Part number	Power (kvar)		Banks U <sub>e</sub> =400V	Weight (kg)	Dim (see chapt. 7) IP00
		U <sub>e</sub> =415V	U <sub>e</sub> =400V			
MINI rack Filter	IW7JFK155050009	5,5	5	2x2.5	14	135
	IW7JFK210050249	11	10	2x5	21	135
	IW7JFK210050009	11	10	10	17	135
	IW7JFK215050009	16	15	5-10	24	135
	IW7JFK220050009	21	20	20	22	135
MULTI rack Filter	IX7JFF220050009	21	20	20	27	130
	IX7JFF240050009	42	40	40	40	130
	IX7JFF260050009	63	60	20-40	65	130
	IX7JFF280050009	84	80	80	56	130

1. Maximum allowed value according to CEI EN 60831-1 art. 20.1



## Other available versions

**FH30/S:** Thyristor switched and detuned capacitor banks, for fast changing loads. Available in MULTImatic only.













# Power factor correction solutions with metallized paper capacitors

## In this chapter you will find the following ranges

	<b>TC10</b>	Fix Power Factor Correction Systems with metallized paper and 400V nominal voltage capacitors
	<b>FD25</b>	Fix Power Factor Correction Systems with 180Hz Detuned Reactors and metallized paper and 460V nominal voltage capacitors

## Other versions and ranges available (see the general catalog on [www.icar.com](http://www.icar.com))

	<b>TC20</b>	Automatic and Fix Power Factor Correction Systems with metallized paper and 460V nominal voltage capacitors.
	<b>TC10/S</b>	Thyristor Switched Automatic Power Factor Correction Systems with metallized paper and 400V nominal voltage capacitors
	<b>TC20/S</b>	Thyristor Switched Automatic Power Factor Correction Systems with metallized paper and 460V nominal voltage capacitors
	<b>FD25/S</b>	Thyristor Switched Automatic detuned Power Factor Correction Systems with 180Hz detuned reactors and metallized paper and 460V nominal voltage capacitors.
	<b>FD25V</b>	High THDV Automatic detuned Power Factor Correction with Systems 180Hz detuned reactors and metallized paper and 460V nominal voltage capacitors.
	<b>FD35</b>	Automatic detuned Power Factor Correction Systems with 135Hz detuned reactors and metallized paper and 550V nominal voltage capacitors.
	<b>FD35/S</b>	Thyristor Switched Automatic detuned Power Factor Correction Systems with 135Hz detuned reactors and metallized paper and 550V nominal voltage capacitors.
	<b>TC70</b>	660/690V Automatic Power Factor Correction Systems with metallized paper and 900V nominal voltage capacitors.
	<b>FD70</b>	660/690V Automatic and fix 180Hz detuned Power Factor Correction Systems with detuned reactors and metallized paper and 900V nominal voltage capacitors.
	<b>FD70V</b>	660/690V, High THDV Automatic detuned Power Factor Correction Systems with 180Hz detuned reactors and high energy density polypropylene film and 900V nominal voltage capacitors.

NB: see page 10 for standard and optional features.



# CRM25

**TECHNICAL CHARACTERISTICS:**

Rated operational voltage	U <sub>e</sub> =400-460-550V
Rated frequency	50Hz
Max current overload I <sub>n</sub>	3xI <sub>n</sub> (continuous) 4xI <sub>n</sub> (x 1600s) 5xI <sub>n</sub> (x 800s)
Max voltage overload V <sub>n</sub>	1.1xU <sub>n</sub>
Insulating voltage	3/15kV - U <sub>e</sub> ≤660Vac
Temperature range	-25/+85°C
Capacitance tolerance	-5÷+10%
Terminal voltage test	2.15xU <sub>N</sub> 10 sec
Service	continuous
Capacitors connection	metallized paper
Standards	IEC 60831-1/2

**GENERALITIES:**

- Metallic case with protection degree IP00
- Internal overpressure protection system
- Oil impregnation vacuum packed.

All components inside this products are compliant with EU Safety Regulations.

Range	Part number	Model	Rated Voltage U <sub>N</sub> (V)	Max. Voltage U <sub>MAX</sub> (V)	Power (kvar)	Capacitance (μF)	Dim (cap7)	Weight (kg)	Pcs/box
TC10	CRMT250163400A0	CRM25-11A-2.50-400	400	440	2,5	50	60x138	0,5	36
TC20 - FD25	CRMM250163400A0	CRM25-11A-2.50-460	460	500	2,5	37	60x138	0,5	36
FD35	CRMR250163400A0	CRM25-11A-2.50-550	550	605	2,5	26	60x138	0,5	36

U <sub>e</sub>	U <sub>N</sub>	U <sub>MAX</sub> <sup>1</sup>	f	THDI <sub>R</sub> %	THDI <sub>C</sub> % <sup>2</sup>
400V	400V	440V	50 Hz	≤27%	≤85%

### TECHNICAL CHARACTERISTICS:

Rated operational voltage	U <sub>e</sub> =400V
Rated frequency	50Hz
Max current overload I <sub>n</sub> (capacitors)	3xI <sub>n</sub> (continuous) 4xI <sub>n</sub> (x 1600s) 5xI <sub>n</sub> (x 800s)
Max current overload I <sub>n</sub> (bank)	1.3xI <sub>n</sub>
Max voltage overload V <sub>n</sub>	1.1xU <sub>n</sub>
Insulating voltage (SUPERriphaso, Riphaso)	3/15kV - U <sub>e</sub> ≤660Vac
Insulating voltage (MICROfix)	690V
Temperature range (bank)	-5/+40°C
Temperature range (capacitors)	-25/+85°C
Discharge device	on each bank
Use	indoor
Service	continuous
Capacitors connection	delta
Total Joule losses	~ 3W/kvar
Inner surface finish (MICROfix)	zinc passivation
Standards (bank)	IEC 60831-1/2
Standards (capacitors)	IEC 61439-1/2, IEC 61921



SUPERriphaso



Riphaso



MICROfix

	Part number	Power (kvar) U <sub>e</sub> =400V	Modules n°	Weight (kg)	Dimens. (see chapt. 7)
SUPER riphaso	SRWT750153C1000	7,5	1	2,1	21
	SRWT150253C2000	15	2	4,2	22
	SRWT225253C3000	22,5	3	6,3	23
	SRWT300253C4000	30	4	8,4	24
	SRWT375253C5000	37,5	5	10,5	25

### SUPERriphaso: Generalities

- Plastic enclosure painted with epossidic dust paint, colour RAL7030
- Protection degree IP40
- Single phase self-healing bimetalized paper capacitors with U<sub>N</sub>=400V rated voltage
- Discharge resistance.

All components inside this products are compliant with EU Safety Regulations.

	Part number	Power (kvar) U <sub>e</sub> =400V	Weight (kg)	Dimens. (see chapt. 7)
Riphaso	RPHT750153C0300	7,5	4,5	31
	RPHT150253C0600	15	6	31
	RPHT225253C0900	22,5	8	32
	RPHT300253C1200	30	9,5	32
	RPHT375253C1500	37,5	11	32

### Riphaso: Generalities

- Metallic enclosure painted with epossidic dust paint, colour RAL 7035
- IP3X protection degree
- Single phase self-healing bimetalized paper capacitors with U<sub>N</sub>=400V rated voltage
- Discharge resistance.

All components inside this products are compliant with EU Safety Regulations.

	Part number	Power (kvar) U <sub>e</sub> =400V	LBS (A)	Weight (kg)	Dimens. (see chapt. 7)
MICROfix	FTVFF1750051A00	7,5	40	8	41
	FTVFF2150051A00	15	40	12	41
	FTVFF2225051A00	22,5	100	15	41
	FTVFF2300051A00	30	125	18	42
	FTVFF2375051A00	37,5	125	20	42
	FTVFF2450051A00	45	125	22	42

### MICROfix: Generalities

- Metallic enclosure internally and externally painted with epossidic dust paint, color RAL 7035
- Load-break switch with door interlock, designed at 1,495 I<sub>n</sub> according to IEC 60831-1 art.34
- N07V-K self-extinguish cable according to IEC 20/22-II and IEC 50627-2-1
- IP 3X degree of protection
- Single phase self-healing metallized paper capacitors with U<sub>N</sub>=400V rated voltage, capacitors equipped with discharge resistors
- Signal lamps power on.

All components inside this products are compliant with EU Safety Regulations.

1. IEC 60831-1 max allowed value  
2. Beyond this value harmonic amplification is likely  
3. Available in IP55 enclosure as well (drawing 43).



# FD25

U <sub>e</sub>	U <sub>N</sub>	U <sub>MAX</sub> <sup>1</sup>	f	THDI <sub>R</sub> %	f	THDV%
400V	460V	500V	50 Hz	≤60%	180 Hz	≤6%

100% NON LINEAR LOAD IN NETWORK

**TECHNICAL CHARACTERISTICS:**

Rated operational voltage	U <sub>e</sub> =400V
Rated frequency	50Hz
Max current overload I <sub>n</sub>	3xI <sub>n</sub> (continuous) 4xI <sub>n</sub> (1600s) 5xI <sub>n</sub> (800s)
Max current overload I <sub>n</sub> (bank)	1.3xI <sub>n</sub>
Max voltage overload V <sub>n</sub>	1.1xU <sub>e</sub>
Insulating voltage (bank)	3/15kV - U <sub>e</sub> ≤660Vac
Temperature range	-5/+40°C
Temperature range (capacitors)	-25/+85°C
Discharge device	on each bank
Service	continuous
Capacitors connection	delta
Perdite Joule totali	~ 6W/kvar
Standards (capacitors)	IEC 60831-1/2
Standards (bank)	IEC 61439-1/2, IEC 6192

**Generalities:**

- Metallic enclosure internally and externally painted with epossidic dust paint, colour RAL 7035
- IP 3X degree of protection
- Single phase self-healing metallized paper capacitors with U<sub>N</sub>=460V rated voltage, capacitors equipped with discharge resistors
- Three phase harmonic blocking reactors, designed for 180Hz blocking frequency (p=7,7%).

All components inside this products are compliant with EU Safety Regulations.

Riphaso	Part number	Power (kvar) U <sub>e</sub> =400V	Weight (kg)	Dimens. (see chapt. 7)
	RPHT250252Z1201	25	32	33

**Other available versions**

**FD25V:** Detuned capacitor, equipped with extended linearity harmonic blocking reactors. Suitable for plants with (THDV≤8%)

1. IEC 60831-1 Maximum allowed value



# TC10

U <sub>e</sub>	U <sub>N</sub>	U <sub>MAX</sub> <sup>1</sup>	f	THDI <sub>R</sub> %	THDI <sub>C</sub> % <sup>2</sup>
400V	400V	440V	50 Hz	≤27%	≤85%



MICRO matic



MINI matic



MULTI matic

### TECHNICAL CHARACTERISTICS:

Rated operational voltage	U <sub>e</sub> =400V
Rated frequency	50Hz
Max current overload I <sub>n</sub> (capacitors)	3xI <sub>n</sub> (continuous) 4xI <sub>n</sub> (1600s) 5xI <sub>n</sub> (800s)
Max current overload I <sub>n</sub> (bank)	1.3xI <sub>n</sub>
Max voltage overload V <sub>n</sub> (bank)	1.1xU <sub>e</sub>
Insulating voltage (bank)	690V
Temperature range (capacitors)	-25/+85°C
Temperature range (bank)	-5/+40°C
Discharge device	on each bank
Use	indoor
Service	continuous
Capacitors connection	delta
Operation devices	capacitors contactors (AC6b)
Total Joule losses	~ 3W/kvar
Inner surface finish	zinc passivation
Standards (capacitors)	IEC 60831-1/2
Standards (bank)	IEC 61439-1/2, IEC 1921

### Generalities:

- Zinc-passivated metallic enclosure painted with epossidic dust paint, colour RAL 7035
- Auxiliary transformer to separate power and auxiliary circuit parts (110V)
- Load-break switch with door interlock designed at 1,495\* I<sub>n</sub> as per IEC 60831-1 art.34
- Contactors with damping resistors to limit capacitors' inrush current
- N07V-K self-extinguish cable according to IEC 20/22/II and IEC 50621-2-1 standards
- Microprocessor Power Factor Correction relay
- Single phase self-healing bimetalized paper capacitors with U<sub>N</sub>=400V rated voltage.

All components inside this products are compliant with EU Safety Regulations.

	Part number IP3X	Power (kvar) U <sub>e</sub> =400V	Banks U <sub>e</sub> =400V	Steps n°	Di- scon- nector (A)	I <sub>cc</sub> <sup>3</sup> (kA)	PFC Controller	Weight (kg)	Dimensions (see chapt. 7)		
									IP3X	IP4X <sup>4</sup>	IP55 <sup>4</sup>
MICRO matic	IC2AFF214050652	14	2-4-8	7	63	50	5LGA	12	49	/	/
	IC2AFF222050652	22	2-4-2x8	11	63	50	5LGA	16	50	/	/
	IC2AFF230050652	30	2-4-3x8	15	80	50	5LGA	17	50	/	/
	IC2AFF236050652	36	4-4x8	9	100	50	5LGA	22	50	/	/
MINI matic	IF2AFF237550652	37,5	7.5-2x15	5	125	9	5LGA	81	55	/	59
	IF2AFF252550652	52,5	7.5-15-30	7	125	9	5LGA	84	56	/	59
	IF2AFF275050652	75	7.5-15-22.5-30	10	250	9	5LGA	94	56	/	59
	IF2AFF290050652	90	7.5-15-30-37.5	12	250	9	5LGA	106	57	/	60
	IF2AFF311250652	112,5	7.5-15-30-60	15	250	9	5LGA	115	57	/	60
	IF2AFF313550652	135	15-2x30-60	9	400	9	5LGA	126	58	/	61
	IF2AFF315050652	150	15-30-45-60	10	400	9	5LGA	132	58	/	61
MULTI matic	IN2AFF316550700	165	15-5x30	11	400	25	8BGA	240	/	72	75
	IN2AFF320650700	206	18.75-5x37.5	11	630	25	8BGA	280	/	72	75
	IN2AFF324850700	248	22.5-5x45	11	630	25	8BGA	300	/	72	75
	IN2AFF328950700	289	26.25-5x52.5	11	630	25	8BGA	340	/	74	81
	IN2AFF333050700	330	30-5x60	11	800	50	8BGA	360	/	74	81
	IN2AFF337150700	371	33.75-5x67.5	11	800	50	8BGA	400	/	70	73
	IN2AFF341350700	413	37.5-5x75	11	1250	50	8BGA	420	/	70	73
	IN2AFF345450700	454	41.25-5x82.5	11	2x630	25	8BGA	580	/	92	83
	IN2AFF349550700	495	45-5x90	11	2x630	25	8BGA	600	/	92	83
	IN2AFF353650700	536	48.75-5x97.5	11	2x630	25	8BGA	640	/	94	85
	IN2AFF357850700	578	52.5-5x105	11	2x800	50	8BGA	660	/	94	85
	IN2AFF361950700	619	56.25-5x112.5	11	2x800	50	8BGA	700	/	94	85
	IN2AFF366050700	660	60-5x120	11	2x800	50	8BGA	720	/	94	85
	IN2AFF370150700	701	63.75-5x127.5	11	2x800	50	8BGA	740	/	90	93
	IN2AFF374350700	743	67.5-5x135	11	2x1250	50	8BGA	760	/	90	93
	IN2AFF378450700	784	71.25-5x142.5	11	2x1250	50	8BGA	820	/	90	93
	IN2AFF382550700	825	75-5x150	11	2x1250	50	8BGA	840	/	90	93

1. Maximum allowed value according to CEI EN 60831-1 art. 20.1

2. Attention: in this conditions of load network harmonic amplification phenomena is possible

3. Other values upon request

4. For part numbers of these executions contact ICAR S.p.A

5. Short-circuit current with fuses

### Other available versions

**TC10/S:** Thyristor switched capacitor banks, for fast changing loads. Available in MULTImatic only.



# FD25

U <sub>e</sub>	U <sub>N</sub>	U <sub>MAX</sub> <sup>1</sup>	f	THDI <sub>R</sub> %	f <sub>N</sub>	THDV%
400V	460V	500V	50 Hz	≤60%	180 Hz	≤6%

100% NON LINEAR LOAD IN NETWORK



### TECHNICAL CHARACTERISTICS:

Rated operational voltage	U <sub>e</sub> =400-415V
Rated frequency	50Hz
Max current overload I <sub>n</sub> (capacitors)	3xI <sub>n</sub> (continuous) 4xI <sub>n</sub> (1600s) 5xI <sub>n</sub> (800s)
Max current overload I <sub>n</sub> (bank)	1.3xI <sub>n</sub>
Max voltage overload V <sub>n</sub> (bank)	1.1xU <sub>e</sub>
Insulating voltage (bank)	690V
Temperature range (capacitors)	-25/+85°C
Temperature range (bank)	-5/+40°C
Discharge device	on each bank
Use	indoor
Service	continuous
Capacitors connection	delta
Operation devices	capacitors
Total Joule losses	~ 6W/kvar
Inner surface finish	zinc passivation
Standards (capacitors)	IEC 60831-1/2
Standards (bank)	IEC 61439-1/2, IEC 61921

### Generalities:

- Zink-passivated metallic enclosure painted with epossidic dust paint, colour RAL 7035
- Auxiliary transformer to separate power and auxiliary circuit parts (110V)
- Load-break switch with door interlock, designed at 1,495\* I<sub>n</sub> as per IEC 60831-1 art.34
- Contactors
- N07V-K self-extinguish cable according to IEC 20/22/II and IEC 50627-2-1 standards
- Microprocessor Power Factor Correction relay
- Control and protection multimeter MCP5, integrated in RPC8BGA controller
- Single phase self-healing bimetalized paper capacitors with U<sub>N</sub>= 460V rated voltage
- Three phase detuning choke with tuning frequency 180Hz (ρ=7,7%).

All components inside this products are compliant with EU Safety Regulations.

	Part number IP3X	Power (kvar) U <sub>e</sub> =400V	Banks U <sub>e</sub> =400V	Steps n°	Disconnecter (A)	I <sub>cc</sub> <sup>2</sup> (kA)	PFC Controller	Weight (kg)	Dimensions (see chapt. 7)		
									IP3X	IP4X <sup>3</sup>	IP55 <sup>3</sup>
MULTImatic	IN5AFF288050701	88	12,5-25-50	7	250	17	8BGA + MCP5	250	/	72	75
	IN5AFF313850701	138	12,5-25-2x50	11	400	25	8BGA + MCP5	315	/	72	75
	IN5AFF317550701	175	25-3x50	7	400	25	8BGA + MCP5	380	/	74	81
	IN5AFF322550701	225	25-4x50	9	630	25	8BGA + MCP5	460	/	70	76
	IN5AFF327550701	275	25-5x50	11	630	25	8BGA + MCP5	520	/	71	77
	IN5AFF335050701	350	2x25-2x50-2x100	14	2x400	25	8BGA + MCP5	740	/	94	85
	IN5AFF340050701	400	2x50-3x100	8	2x630	25	8BGA + MCP5	800	/	94	85
	IN5AFF345050701	450	50-4x100	9	2x630	25	8BGA + MCP5	860	/	90	96
	IN5AFF350050701	500	2x50-4x100	10	2x630	25	8BGA + MCP5	920	/	90	96
	IN5AFF355050701	550	50-5x100	11	2x800	50	8BGA + MCP5	980	/	91	95
	IN5AFF360050701	600	2x50-3x100-200	12	2x800	50	8BGA + MCP5	1040	/	91	95
	IN5AFF365050701	650	50-4x100-200	13	3x630	25	8BGA + MCP5	1330	/	101	103
	IN5AFF370050701	700	2x50-2x100-2x200	14	3x630	25	8BGA + MCP5	1355	/	101	103
	IN5AFF375050701	750	50-3x100-2x200	15	3x630	25	8BGA + MCP5	1380	/	101	103
	IN5AFF380050701	800	2x50-100-3x200	16	3x800	50	8BGA + MCP5	1495	/	102	104
IN5AFF385050701	850	3x50-3x100-2x200	17	3x800	50	8BGA + MCP5	1525	/	102	104	
IN5AFF390050701	900	3x100-3x200	9	3x800	50	8BGA + MCP5	1560	/	102	104	

1. Maximum allowed value according to IEC 60831-1 art. 20.1

2. Other values upon request

3. For part numbers contact ICAR Spa

### Other available versions

**FD25/S:** Thyristor switched capacitor banks, for fast changing loads. Available in MULTImatic only.

**FD25V:** Detuned capacitor bank, equipped with extended linearity harmonic blocking reactors. Expressively designed for plants with THDV≤8%.

U <sub>e</sub>	U <sub>N</sub>	U <sub>MAX</sub> <sup>1</sup>	f	THDI <sub>R</sub> %	THDI <sub>C</sub> % <sup>2</sup>
400V	400V	440V	50 Hz	≤27%	≤85%



MICRO rack



MINI rack



MULTI rack

### TECHNICAL CHARACTERISTICS:

Rated operational voltage	U <sub>e</sub> =400V
Rated frequency	50Hz
Max current overload I <sub>n</sub> (capacitors)	3xI <sub>n</sub> (continuous) 4xI <sub>n</sub> (1600s) 5xI <sub>n</sub> (800s)
Max current overload I <sub>n</sub> (tray)	1.3xI <sub>n</sub>
Max voltage overload V <sub>n</sub> (tray)	1.1xU <sub>e</sub>
Insulating voltage (tray)	690V
Temperature range (capacitors)	-25/+85°C
Temperature range (tray)	-5/+40°C
Discharge device	on each bank
Use	indoor
Service	continuous
Capacitors connection	delta
Operation devices	contactors for capacitors (AC6b)
Total Joule losses	~ 3W/kvar
Inner surface finish	zinc passivation
Standards (capacitors)	IEC 60831-1/2
Standards	IEC 61439-1/2, IEC 61921

### Generalities:

- Contactors with damping resistors to limit capacitors' inrush current
- N07V-K self-extinguish cable according to IEC 20/22/II and IEC 50627-2-1 standards
- Three-phase fuse holder type NH00
- Power fuses NH00-gG
- Single phase self-healing bimetalized paper capacitors with U<sub>N</sub>=400V rated voltage
- Discharge devices.

All components inside this products are compliant with EU Safety Regulations.

	Part number	Power (kvar) U <sub>e</sub> =400V	Banks U <sub>e</sub> =400V	Weight (kg)	Dim (see chapt. 7) IP00
MICRO rack	IC2FFF120050000	2	2	2	108
	IC2FFF140050000	4	4	2	108
	IC2FFF180050000	8	8	2	108
MINI rack	NRVF17505101100	7,5	7,5	10	110
	NRVF21505101100	15	15	11	110
	NRVF22255103200	22,5	7.5-15	13	110
	NRVF23005102200	30	2x15	14	110
	NRVF23755105300	37,5	7.5-2x15	16	110
MULTI rack	MRKT41225318600	41,25	3.75-5x7.5	19	120
	MRKT82525333600	82,5	7.5-5x15	27	120

1. Maximum allowed value according to CEI 60831-1 art. 20.1

2. Attention: in this conditions of load network harmonic amplification phenomena is possible

### Other available versions

**TC10/S:** Thyristor switched capacitor banks, for fast changing loads. Available in MULTImatic only.

U <sub>e</sub>	U <sub>N</sub>	U <sub>MAX</sub> <sup>1</sup>	f	THD <sub>I<sub>R</sub></sub> %	f <sub>N</sub>	THDV%
400V	460V	500V	50 Hz	≤60%	180 Hz	≤6%

100% NON LINEAR LOAD IN NETWORK



MULTI  
rack

### TECHNICAL CHARACTERISTICS:

Rated operational voltage	U <sub>e</sub> =400V
Rated frequency	50Hz
Max current overload I <sub>n</sub> (capacitors)	3xI <sub>n</sub> (continuous) 4xI <sub>n</sub> (1600s) 5xI <sub>n</sub> (800s)
Max current overload I <sub>n</sub> (tray)	1.3xI <sub>n</sub>
Max voltage overload V <sub>n</sub> (tray)	1.1xU <sub>e</sub>
Insulating voltage (tray)	690V
Temperature range (capacitors)	-25/+85°C
Temperature range (tray)	-5/+40°C
Discharge device	on each bank
Use	indoor
Service	continuous
Capacitors connection	delta
Operation devices	capacitors
Total Joule losses	~ 6W/kvar
Inner surface finish	zinc passivation
Standards (capacitors)	IEC 60831-1/2
Standards (tray)	IEC 60439-1/2, IEC 61921

### Generalities:

- Contactors
- N07V-K self-extinguish cable according to IEC 20/22/II and IEC 50627-2-1 standards
- Three-phase fuse holder type NH00
- Power fuses NH00-gG
- Single phase self-healing bimetalized paper capacitors with U<sub>N</sub>= 460V rated voltage
- Discharge devices
- Three phase detuning choke with tuning frequency 180Hz (ρ=7,7%).

All components inside this products are compliant with EU Safety Regulations.

	Code	Power (kvar) U <sub>e</sub> =400V	Banks U <sub>e</sub> =400V	Weight (kg)	Dim (see chapt. 7) IP00
MULTI rack	MRKT25025112101	25	25	24	130
	IX5AFF237550010	37,5	12,5-25	35	130
	MRKT50025924100	50	50	46	130

1. Max allowed value according to IEC 60831-1 art. 20.1

### Other available versions

**FD25/S:** Thyristor switched capacitor banks, for fast changing loads. Available in MULTImatic only.

**FD25V:** Detuned capacitor bank, equipped with extended linearity harmonic blocking reactors. Expressively designed for plants with THDV≤8%.



# Passive and active harmonic filters

## Passive Filters

ICAR proposes FT10 passive filters tuned on the 5<sup>th</sup> harmonic, made with bimetalized paper capacitors, for a better durability guarantee and long-term absorption precision.

The FT10 passive filters are available in MULTImatic enclosures and standard versions ranging from 60kvar (120A 5<sup>th</sup> harmonic current consumption) to 180kvar (360A). It is possible to create custom versions.

Refer to Power Factor Correction general catalog on [www.icar.com](http://www.icar.com)



MULTI  
matic

## Active filters

The presence of a strong harmonic content in the current flowing in the electric system can cause significant problems:

- Malfunction of electric devices
- Tripping of protection devices
- Overheating of cables, bars, transformers
- Vibration and breakage due to mechanical stress
- Increase the voltage drops on the lines
- Voltage distortion.

The active filter is an electronic device that measures the line current harmonic content, calculates the individual harmonic components in the network and for each inject an equal current (per module and harmonic order) but in phase opposition. In this way it eliminates the present harmonics and leaves unchanged the current at network frequency.

The active filters are preferred when the network harmonic content is on a wide spectrum (for example, the 3<sup>rd</sup>, the 5<sup>th</sup>, the 7<sup>th</sup>, the 11<sup>th</sup>, the 13<sup>th</sup>) and/or when there is a resonance risk.

The active filters are dimensioned for current, considering the total rms value of the harmonic currents that are to be deleted from the network.

The FA30 active filters are made with digital technology and are able to guarantee high performance in terms of:

- Speed of response
- Robustness and reliability for use in heavy industrial environments
- Speed of maintenance / repair
- Adaptation to changes in the network harmonic content due to changes in the network topology and / or new non-linear loads presence.

The FA30 active filters are available in several versions, from 30A 400V.

For more information, see the documentation on the website [www.icar.com](http://www.icar.com) or consult your Regional Sales Office.



# Reactive power regulators and protections

The reactive power regulator is, together with the capacitors and reactors (in detuned filter cabinets), the key component of the automatic power factor correction system. It is in fact the "intelligent" element, responsible for the verification of the power factor of the load, in function of which controls the switching on and off of the capacitors batteries in order to maintain the power factor of the system beyond the target.

The reactive power regulators RPC used in automatic ICAR power factor correction systems are designed to provide the desired power factor while minimizing the wearing on the banks of capacitors, accurate and reliable in measuring and control functions are simple and intuitive in installation and consultation.

By purchasing a ICAR automatic power factor correction system you receive it ready for commissioning. In fact the controller is already set, you just need to connect it to the line CT and set the value of the primary current.

The controller automatically recognizes the current direction of the CT secondary, to correct any wiring errors.

The flexibility of ICAR regulators allows you to modify all the parameters to customize its operation to fit the actual characteristics of the system to be corrected (threshold power factor, sensitivity of step switching, reconnecting time of the steps, presence of photovoltaics, etc.).

As described below, the ICAR regulators offer important features as for the maintenance and management of the power factor correction bank, aimed at identifying and solving problems, which could lead to its damage with consequent life expectancy reduction.

















RPC 5LGA



RPC 8LGA



RPC 8BGA

System Range	PFC Controller
 MICROmatic	RPC 5LGA 
 MINImatic	RPC 5LGA 
 MINImatic filter	RPC 5LGA 
 MIDImatic	RPC 8LGA 
 MIDImatic filter	RPC 8BGA +MCP5 standard 
 MULTImatic	RPC 8BGA +MCP5 opzionale 
 MULTImatic filter	RPC 8BGA +MCP5 in standard 

## Reactive power regulators 5LGA RPC and RPC 8LGA

The new reactive power regulator RPC 5LGA equips Micromatic and Minimatic automatic power factor correction systems, while the new regulator RPC 8LGA equips MIDimatic. Both are managed by a microprocessor and offer many features maintaining a simple user interface locally or from a PC. They are characterized by a large LCD display with text messages (in 6 languages: ITA, ENG, FRA, SPA, POR, GER) and icons for quick and intuitive navigation.

The regulators are very flexible: they are in fact able to adjust the power factor between 0,8 inductive and 0,8 capacitive, to operating with power from 100 to 440 VAC, to run on the 4 quadrants for cogeneration installations, to accept in Input CT secondary 5A or 1A .

The regulators have standard temperature control and the ability to configure one of the available relays for activating visual alarms sound at a distance; also control the distortion of current and voltage.

Regulators RPC 5LGA-8LGA can operate in automatic or manual mode: in the first case in complete autonomy by switching batteries available up to the desired power factor; in the second case it will be the operator to force the insertion and disconnection of the battery: the regulator still oversee operations to prevent potential damage to the capacitors (for example by assessing compliance of discharge times before a subsequent insertion).

The slot allows you to add additional functions:

- OUT2NO for two additional digital outputs
- COM485 communication module for connection to network RS485 (Modbus)
- COM232 communication module for connection to network RS232 (Modbus)
- WEBETH communication module for connection to the Ethernet network (Modbus), available only for RPC 8LGA.

### Measurement functions

Regulators RPC 5LGA and 8LGA provide many standard measurements in order to check and monitor the correct electrical and temperature conditions of the power factor correction system. Display shows the following values: power factor, voltage, current, delta kvar (reactive power missing to reach the target power factor), average weekly power factor, total harmonic distortion of the current system (THDI<sub>R</sub>%) with detailed harmonic for harmonic from 2nd to 15th, total harmonic distortion of the voltage (THDV%) with detail for harmonic from 2nd to 15th, total harmonic distortion in the current% (THDI%) capacitor, temperature. The controller stores and makes available for consultation the maximum value of each of these variables, to evaluate the most severe stress suffered by the automatic power factor correction since the last reset: the temperature, the voltage and the total harmonic distortion have a strong impact on the capacitors as if they hold more than the nominal values can drastically reduce the service life.



### Alarms

Regulators RPC ICAR show many different alarms:

- Under-compensation: the alarm is activated if, with all the steps of power factor correction switched on, the power factor is lower than the desired value
- Over-compensation: the alarm is activated if, with all the steps of power factor correction switched off, the power factor is greater than the desired value
- Minimum and maximum current: to assess the condition of the system load
- Minimum and maximum voltage: to evaluate the stresses due to the variations of the supply voltage
- Maximum THD%: to assess the pollution of network as regards to harmonic current
- Maximum temperature in the enclosure: to monitor the capacitor climatic conditions
- Short voltage interruptions.

Alarms are programmable (enable, threshold, time on / off).

### Display Indications

The LCD display icons and text provides the following information for quick identification of the state of the system:

- Operating mode automatic/manual
- Status of each battery (on / off)
- Recognition power factor inductive / capacitive
- Type of value displayed
- Active alarm code, and explanatory text (in a language of choice among the 6 available: ITA, ENG, FRA, SPA, POR, GER).

### Contacts

The regulators RPC 5LGA and 8LGA have power contacts for controlling the steps, to control the eventual cooling fan and for the activation of alarms to distance; contacts are NO and have a range of 1.5A to 5A at 250Vac or 440Vac. A contact is in exchange for alarm functions (NO or NC).

## Technical characteristics

- Microprocessor control
- Auxiliary supply voltage: 100 to 440 VAC
- Frequency: 50Hz / 60Hz
- Voltage measuring input : 100 to 600V
- Current measuring input : 5A (1A programmable)
- Current reading range: from 25mA to 6A (from 25mA to 1.2A)
- Automatic current way sensing: yes
- Operation in systems with cogeneration: yes
- Power consumption: 9.5 VA
- Output relay : 5A - 250Vac
- Cos  $\phi$  adjustment: from 0.5 ind to 0.5 cap
- Step Switching Time: 1s ÷ 1000s
- Alarm relay: yes
- Degree of protection: IP54 on front and IP20 at terminals
- Operating temperature: -20 ° C to + 60 ° C
- Storage temperature: -30 ° C to + 80 ° C
- Optical port Front: for communication USB or WIFI with dedicated accessories
- Compliance with the standards: IEC EN 61010-1; IEC / EN 61000-6-2; IEC / EN 61000-6-4; UL508; CSA C22-2 n ° 14.

	RPC 5LGA	RPC 8LGA
<b>Output relays:</b>	5 (up to 7)	8 (up to 12)
<b>Dimensions:</b>	96x96mm	144x144mm
<b>Weight:</b>	0,35kg	0,65kg

## Additional modules

The regulator RPC 5LGA has the ability to accommodate, in the back slot, an additional module.

The regulator RPC 8LGA has two rear slots to accommodate up to two additional modules. Once installed an additional module, the controller recognizes and activates the menu for its programming. Additional modules can be installed even in the bank already in service.

Slots for additional module may be already used by ICAR to implement necessary functions to the context in which the controller is mounted. If you decide to add a module to an already operating, ensure that there is an available slot.

- OUT2NO two digital outputs device to control additional steps (two relays 5A 250Vac)
- COM232 interface RS232 isolated
- COM485 interface RS485 isolated
- WEBETH communication module for connection to the Ethernet network, available only for RPC 8LGA.

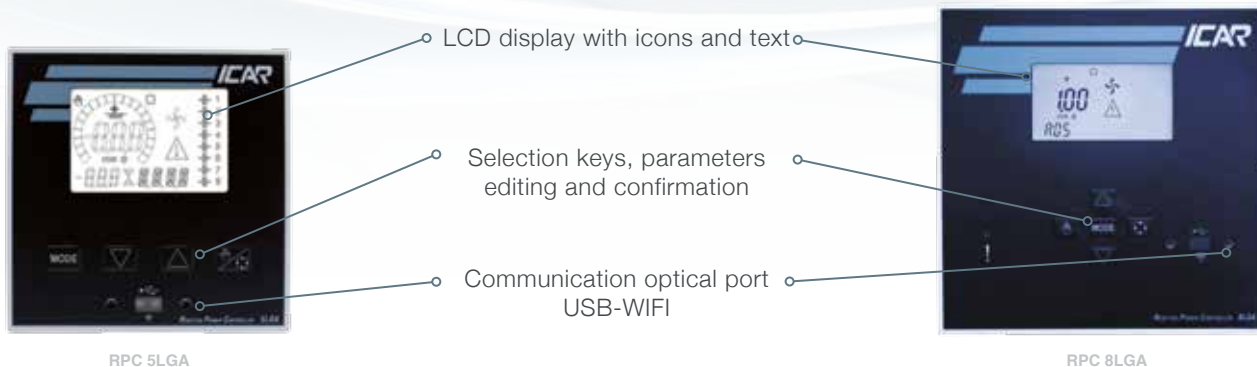

# Reactive power regulators RPC 8BGA

The RPC 8BGA reactive power regulator equips MULTImatic automatic power factor correction systems.

It is a very innovative controller, with exclusive features:

- High electrical performance
- Extended Capabilities
- Graphic display
- Advanced communication
- Upgradability, even after installation
- Powerful supervision software.

More details below, referring to the following page tables and manuals for further information.

**High electrical performance:** The 8BGA controller is equipped with powerful hardware, which allows a considerable electrical performances: it can be connected to the CT secondary 5A or 1A, it can work on networks with voltages from 100 to 600Vac with a measuring range from 75VAC to 760VAC, it can be connected to a single CT (typical configuration of the power factor correction) or three-CTs (for a more accurate measurement of the power factor, and this fact makes the 8BGA controller to refocus and to be a multimeter as well).

**Extended Capabilities:** The 8BGA reactive power regulator is controlled by a powerful microprocessor that allows a set of new functions to solve problems even in complex plant.

8BGA can work master-slave functions, handles up to 10 languages simultaneously, can be used in MV systems managing the transformation ratio of the VT, it can support multiple inputs and outputs via optional modules, it can handle target cos phi from 0.5 inductive to 0.5 capacitive. 8BGA can build a network of 4 wired units (one master three slaves) to be able to handle up to 32 steps of power factor correction in a consistent and uniform way.

**Graphical display with high readability:** forget the regulators with small displays and difficult to read: 8BGA will amaze you with its display matrix graphic LCD 128x80 pixels.

The detail and sharpness allow intuitive navigation between the different menus, represented with text and icons.

**Advanced communication:** 8BGA born to be a regulator able to communicate in a manner in line with the latest technology: Ethernet, RS485, GSM / GPRS modem, USB, WIFI.

Now you can see the information of the company cos phi, without having to go in front of the regulator. It will be the controller to inform you by posting, if you wish, SMS or email. Or you can consult a tablet, a smartphone, or PC.

The information about the cos phi is important, because it impacts heavily on the company's income statement.

**Evolutivity:** the "basic" 8BGA regulator can be enhanced with up to four additional modules "plug and play" which greatly expands its performance. And 'possible to add additional control relays (up to a total of 16), even for a static control (thyristors), digital and analog inputs, analog outputs, communication modules. Your controller can become a small PLC, and the PFC system can become a point of data aggregation, for remote communication.

## Measurement functions and help to maintain

8BGA is a real evolved multimeter, thanks also to the graphic display of excellent readability and to the powerful microprocessor . The measured parameters are the basic ones (cos phi, FP, V, I, P, Q, A, Ea, Er) with the addition of the distortion of the voltage and current (THD, histogram of the value of each harmonic, waveform graphic visualization).

If 8BGA is connected to three CT, the harmonic analysis is detailed for each phase, in order to identify any anomalies of single phase loads. 8BGA measure and count values that can help in ruling the PFC (temperature, number of switching of each step). 8BGA also suggests the maintenance to be carried out by means of simple messages on the display.

Keep efficient capacitor becomes much easier.

8BGA stores the maximum values of current, voltage, temperature, each associated with the date and time of the event for a better analysis of what happened.

## Alarms

The set of alarms (maximum and minimum voltage, maximum and minimum current, over and under-compensation, overload of the capacitors, maximum temperature, microinterruption) associated with the readability of the messages on the display allows a better understanding of what happened.

Even alarm programming (enable / disable, delay, relapse etc.) is easier and faster.



## 8BGA Power Factor Correction Controller: Technical parameters

### Technical characteristics

- Auxiliary supply voltage: 100÷440Vac
- Frequency: 50Hz/60Hz
- Voltage Measuring range: 100÷600Vac (-15% / +10%)
- Current Measuring range: 5A (1A selectable)
- Current incoming range: from 25mA to 6A (from 10mA to 1,2A)
- Automatic phase sequence reading: yes
- Compensation in cogeneration: yes
- Burden: 9,5 VA
- Output relay current: 5A – 250Vac
- Cos  $\phi$  range: from 0,5 ind to 0,5 cap
- Step switching time: 1s÷1000s
- Alarm relay: yes
- Degree of protection: IP54
- Working temperature range: from -20°C to 60°C
- Storage temperature range: from -30°C to + 80°C
- USB optic communication port (with COMUSB)
- Temperature Control: from -30°C to +85°C
- Standards compliance: IEC EN 61010-1; IEC/EN 61000-6-2; IEC/EN 61000-6-3; UL508; CSA C22-2 n°14
- Step output relays: 5 (expandible till 7)
- Dimensions: 96x96mm
- Weight: 0,35Kg
- Part number: A25060046411000.

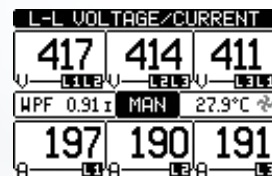
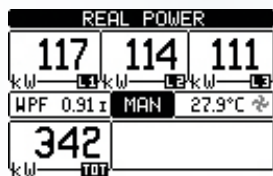
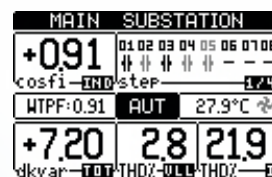
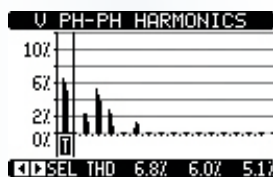

Selection, modification and enter push buttons.

LED watchdog and alarm

Graphic display 128x80 pixel

USB – WIFI Optic netport

## RPC 8BGA Power Factor Correction Controller: additional modules

The RPC 8BGA controller accommodates up to 4 additional modules "plug & play".

Once you have added an additional module, the controller recognizes and activates the menu for its programming. Additional modules can also be installed in the rear.

### Digital inputs and outputs

These modules allow you to increase the contacts funding for control of the steps contactors (OUT2NO module) or thyristors (STR4NO module) switched banks, or to add inputs and / or digital / analog acquisition of parameters and implementing simple logic.

- OUT2NO module 2 digital outputs to control additional steps (two relays 5A 250 Vac)
- STR4NO module 4 static outputs for thyristor control steps (range SPEED)
- INP4OC module 4 digital inputs
- 2IN2SO module 2 digital inputs and 2 static outputs
- INP2AN module 2 analog inputs
- OUT2AN module 2 analog outputs.



### Protection functions (MCP5) and data logging (DATLOG)

The control and protection module MCP5 allows a more detailed inspection of the electrical parameter that can damage the capacitors, thanks to algorithms particularly suitable for equipment consisting of capacitors and reactors (detuned filters MULTImatic FH20, FH30, FD25, FD25V, FD35, FH70, FD70).

The data logging module adds the ability to record events, for a better understanding and diagnosis of troubled plants.

- MCP5 module for protection and control for additional safety of capacitors, especially suitable in the detuned banks
- DATLOG data logger module with real time clock and battery backup for data retention.

### Communication functions

RPC 8BGA regulator is very powerful in terms of communication.

The modules dedicated to these functions allow multiple solutions to remotely control the power factor system and all other variables measured, calculated or obtained from the instrument.

- COM232 isolated RS232 interface
- COM485 RS485 opto-isolated
- WEBETH Ethernet interface with webserver function
- COMPRO isolated Profibus-DP interface
- COMGSM GPRS / GSM modem
- CX01 cable connection from the RPC 8BGA optical port to the USB port of the computer for programming, downloading / uploading data, diagnostics etc
- CX02 device to connect the optical port in the PRC 8BGA via WIFI: for programming, downloading / uploading data, diagnostics etc



### App<sup>1</sup>

App available for WIFI interfacing with the RPC 8BGA controller via tablet or smartphone. For iOS and Android.

You have the following functions:

- Set of up regulator
- Sending commands
- Reading information
- Download information and data residing on board.

1. For availability contact us



# Enerscope-3S

## Portable Power Quality and Energy Analyzer



Enerscope-3S is the ideal tool for both Power Quality troubleshooting and discovering Energy Savings.

### Main benefits:

- Three-phase measuring and logging instrument
- Include Power Factor Correction and Harmonics measurements
- Economic
- Easy and ready to use
- Portable
- Autonomy of over 24 hours with rechargeable batteries.

### Main features

- Handheld product and therefore, light and easy to use
- 4 voltage measuring channels: 3 with common neutral + 1 auxiliary independent
- 5 current inputs: 3 independent + 1 for neutral current + 1 auxiliary
- Equipped with flexible current clamps up to 3000A
- High performance battery pack with more than 24 hours of battery life, so that extended measurement campaigns can also be performed without using main power supply
- Powerful but compact external power supply, compatible with all types of sockets (USA/JP, EU, UK, AU)
- Multilingual menus (English, Italian, German, Spanish, French)
- Automatic connection test to check if electrical connections are correct
- Micro SD memory card for extended measurement campaigns
- Special PC software, allowing for advanced analysis of data stored on USD card.

### Functionalities

Calculation engine based on 16bit microprocessor, allowing for the measurement of all electrical parameters (V I P Q A F PF THD% etc.) in TRMS value, as well as:

- Measurement of minimum, average and peak instant values on 4 quadrants (absorbed and generated)
- Absorbed and generated power counters (kWh kVA kVAr), which can be password protected
- Current and voltage harmonics (all 7 input channels) up to the 50th order
- Network interruptions & microinterruptions
- Dips (brownouts)
- Swells (overvoltages)
- EN50160 test (reference standard for power quality)
- Event log (last 5 alarms, 5 dips, 5 swells, 5 interruptions)
- Power measurement over 4 time periods (tariffs), which can be set for threephase and each single phase
- 6 different electrical systems which can be analysed: single-phase; two-phase; three-phase (unbalanced); three-phase + neutral (unbalanced); three-phase (balanced); three-phase + neutral (balanced)
- Medium voltage connection available
- Solar inverter efficiency measurement.

### Power menu:

Active [W]	PF	Reactive [var]	PF	Apparent [VA]	PF	Power Factor	Load	Avg P-Q-S-PF [AUX]	Min P-Q-S-PF [AUX]	Max P-Q-S-PF [AUX]	Max Q P-Q-S-PF [AUX]
L1 3.637k	0.94	L1 1.224k	0.94	L1 3.788k	0.94	L1 0.947	Cap	P 3.565k W	P 0.000 W	P 128.5k W	P 6.849k W
L2 5.538k	0.96	L2 1.525k	0.96	L2 5.700k	0.96	L2 0.968	Ind	Q 1.247k var	Q -2.999k var	Q 33.86k var	Q 1.663k var
L3 6.818k	0.93	L3 2.516k	0.93	L3 6.801k	0.94	L3 0.975	Ind	S 3.816k VA	S 0.000 VA	S 132.9k VA	S 7.085k VA
3PH 15.99k		3PH 5.266k		3PH 16.28k		3PH 0.993	Ind	PF 0.934 Ind	PF 0.000 Ind	PF 0.995 Ind	PF 0.969 Ind
Endv L2: 1.646		Endv L2: 1.630		Endv L2: 2.085		Endv L2: 1.941		Vrms 3F: 394.8	Endv L2: 1.244	Endv L2: 2.085	Vrms 3F: 393.9



# Dimensions

Dimensions tolerance  $\pm 10\text{mm}$

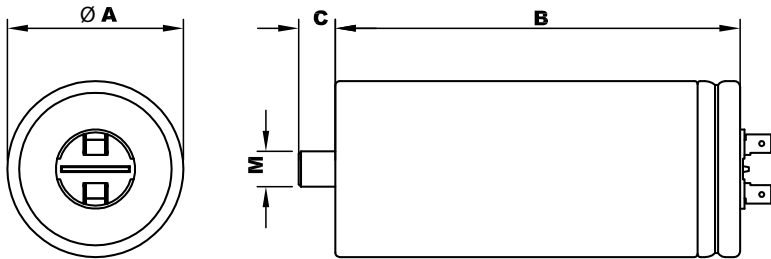

Drawing	$\varnothing A$	B	C	M
1	40	103	10	8
2	45	128	10	8
3	55	128	12,5	12
4	60	138	12,5	12

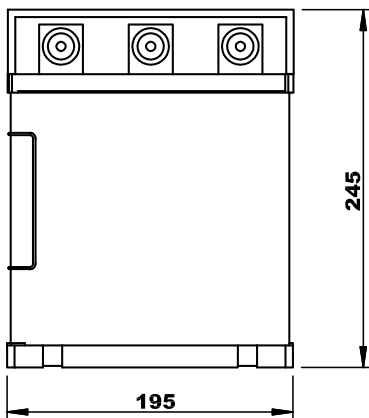

Drawing	C	C1	C2	C3	C4	C5
21	89					
22		165				
23			241			
24				317		
25					393	
26						469

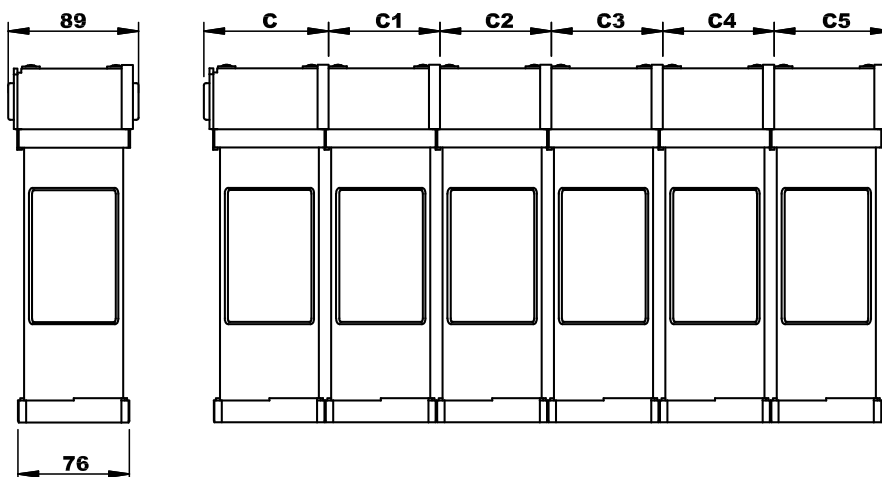

31

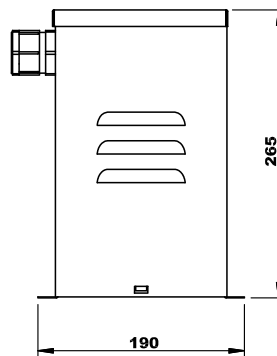
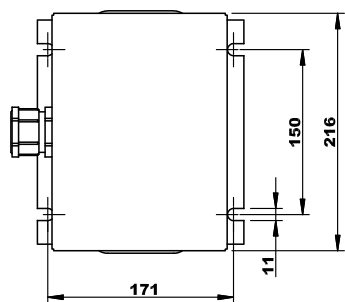

32

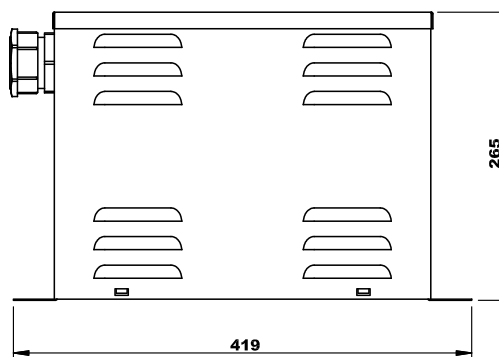
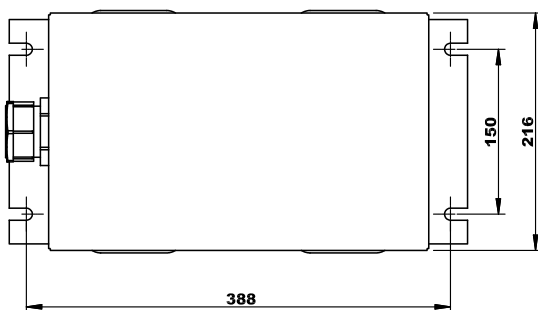

33

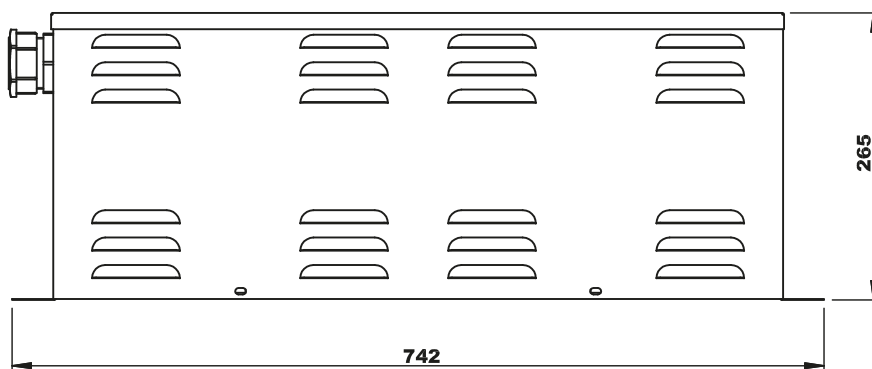

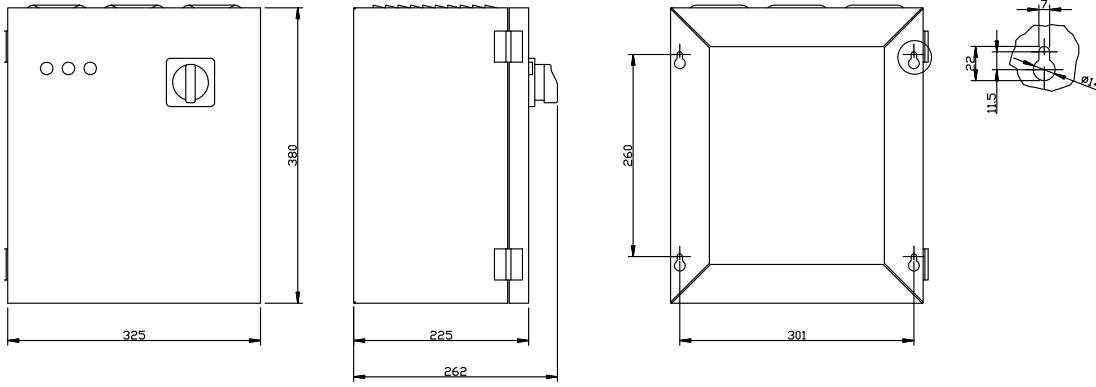

41

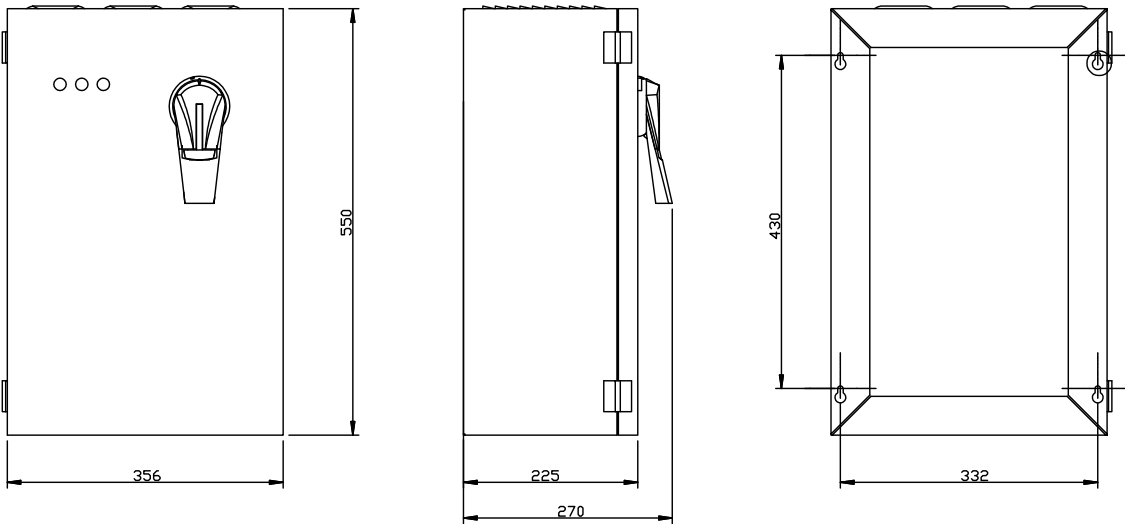

42

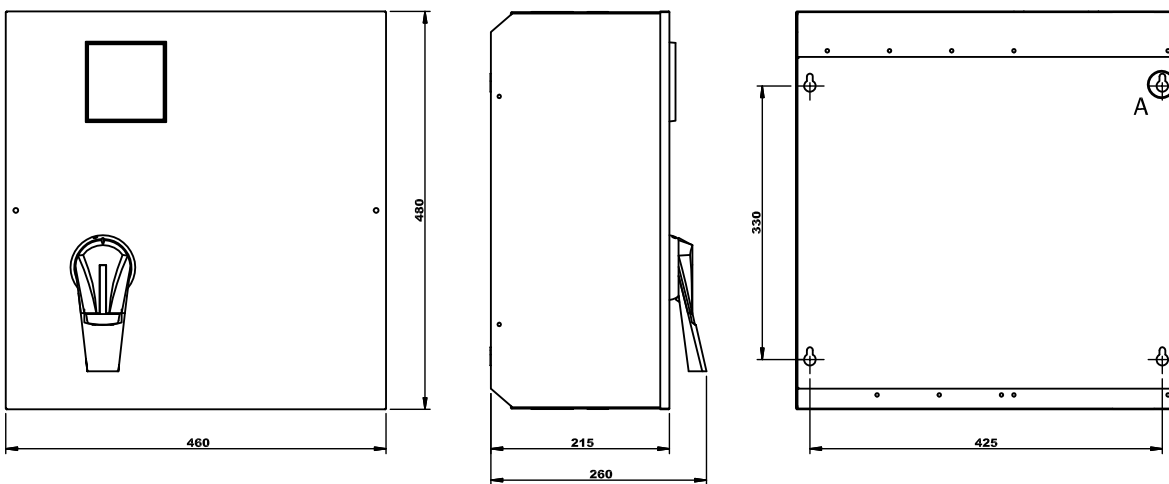

49

# DIMENSIONS

50

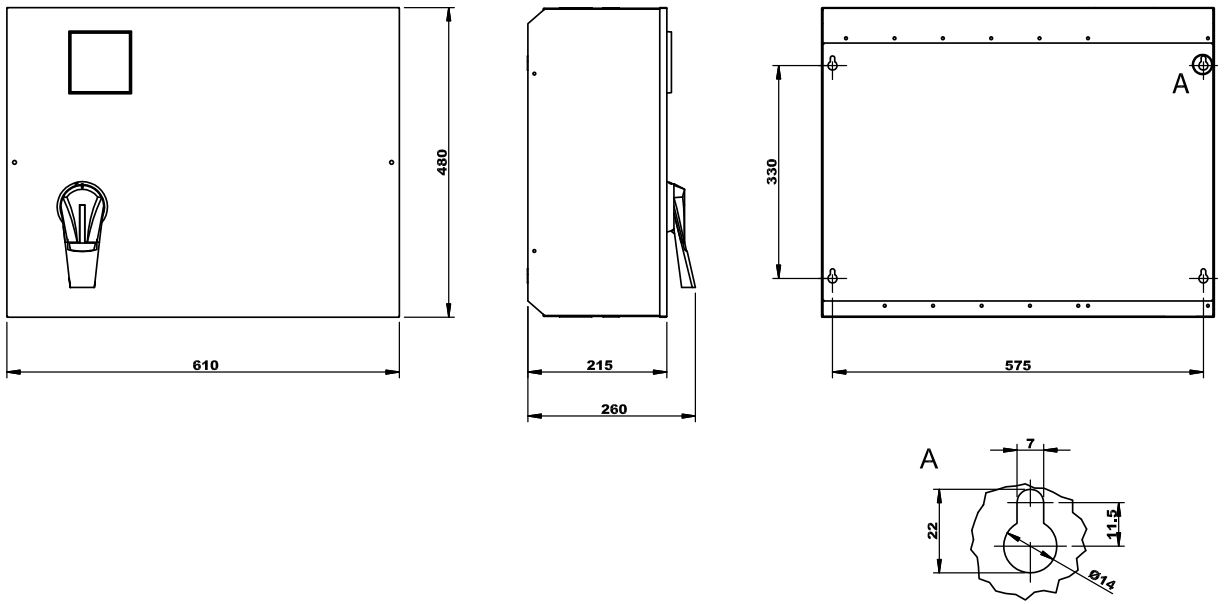

Applicable to drawings  
55, 56, 57, 58

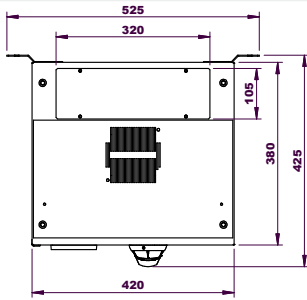

Top view with cable incoming inlet

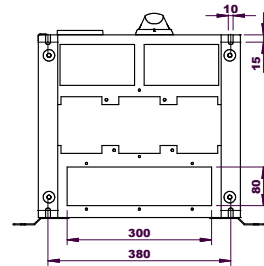

Bottom view with cable incoming inlet

55

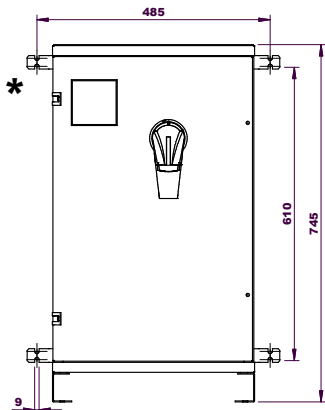

\* Fixing pads are removable

56

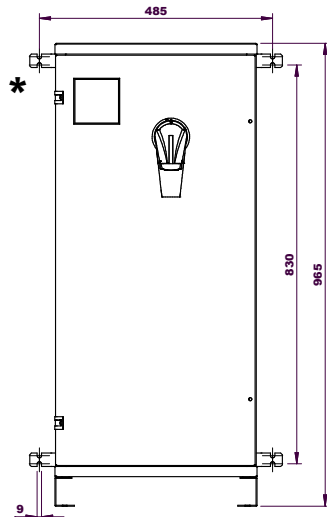

Fixing pads are removable

57

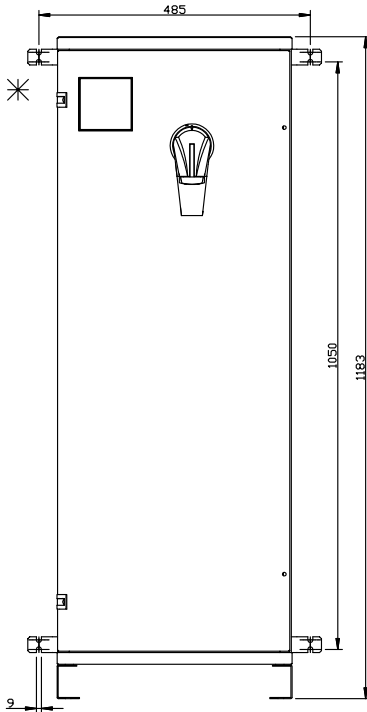

58

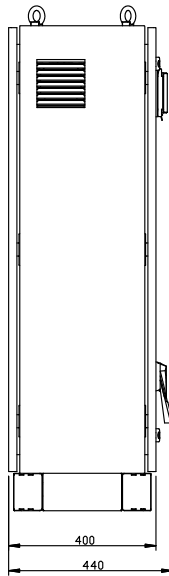
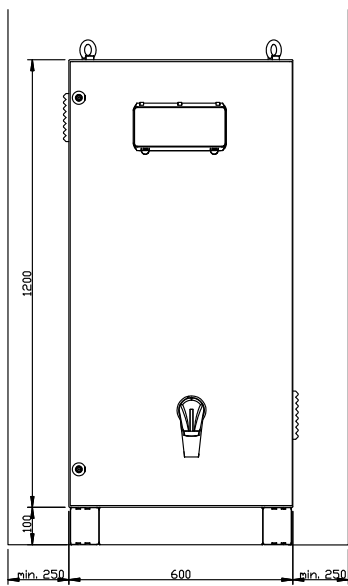
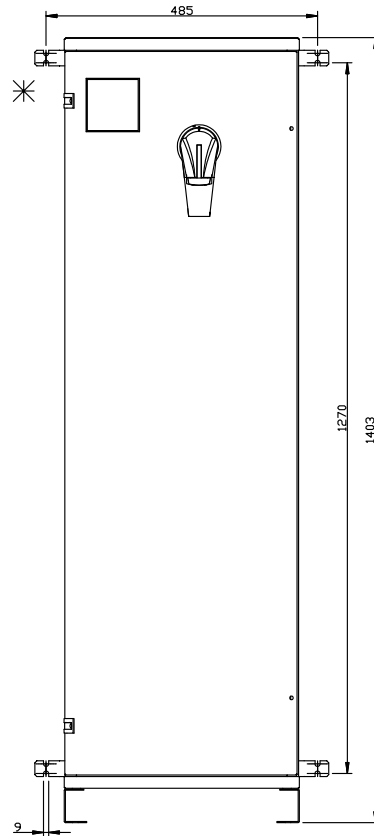

Bottom view with cable incoming inlet

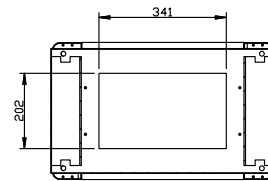

Floor cabinet fixing

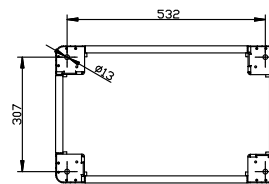

59

60

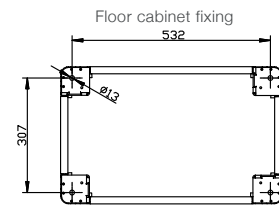
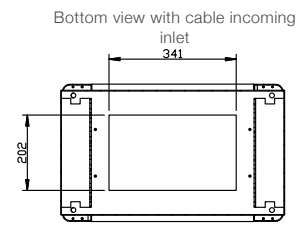
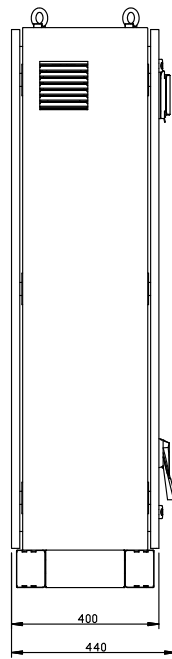
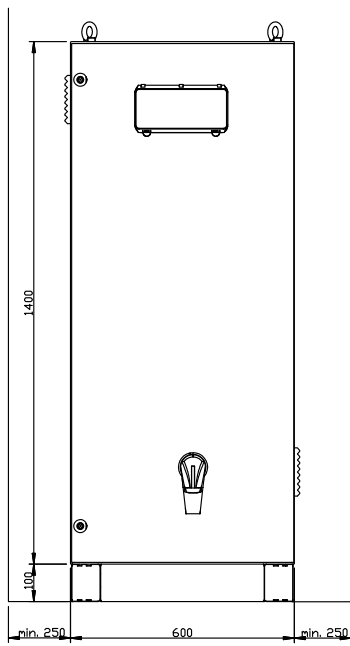

61

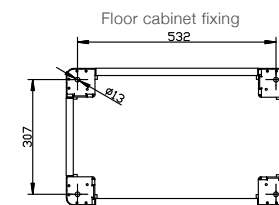
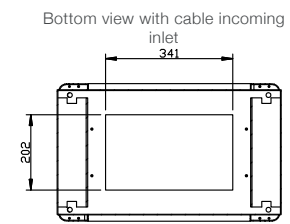
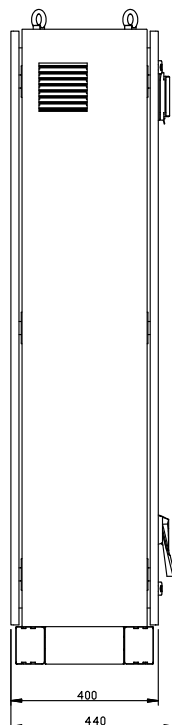
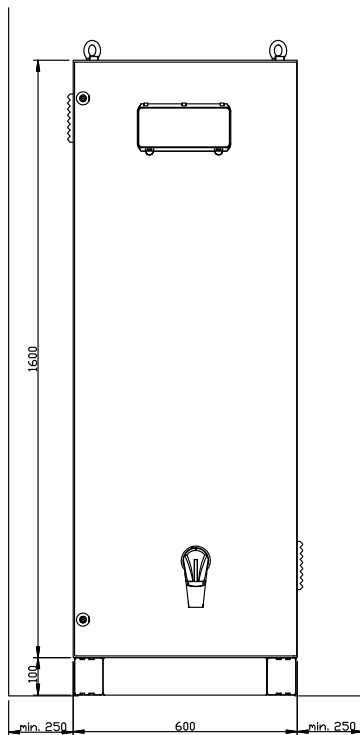

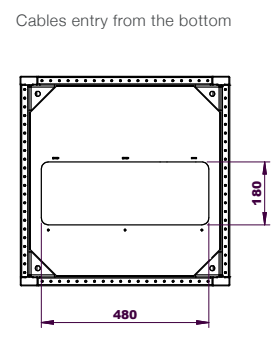
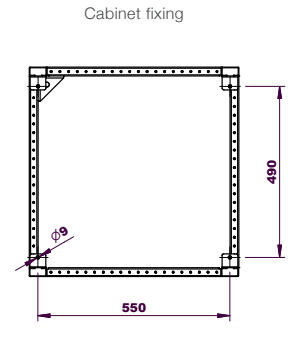
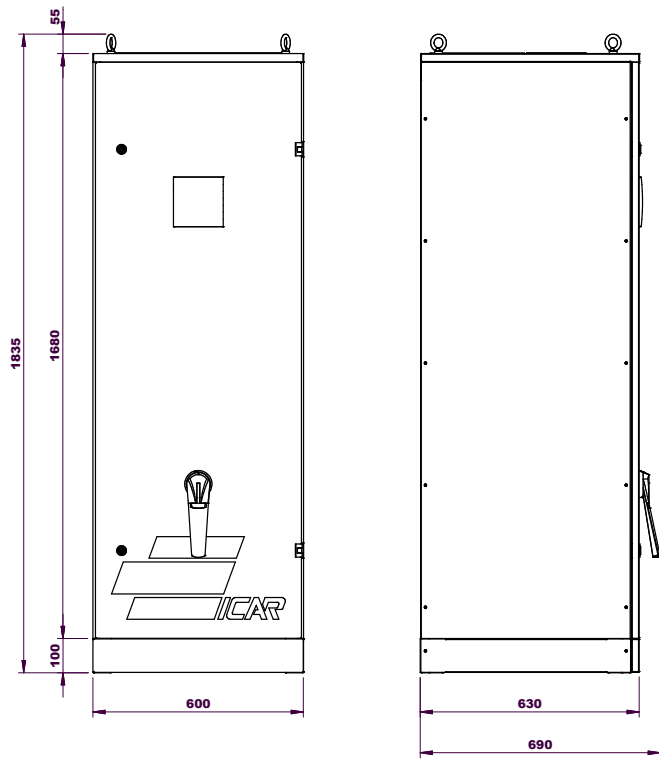

64

Applicable to drawings  
70, 71, 72, 73, 74, 75,  
76, 77, 78, 80, 81, 82

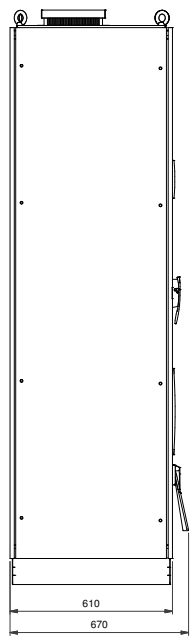
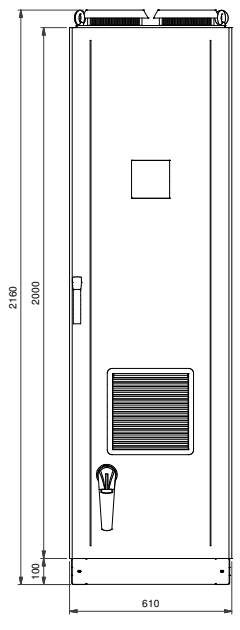
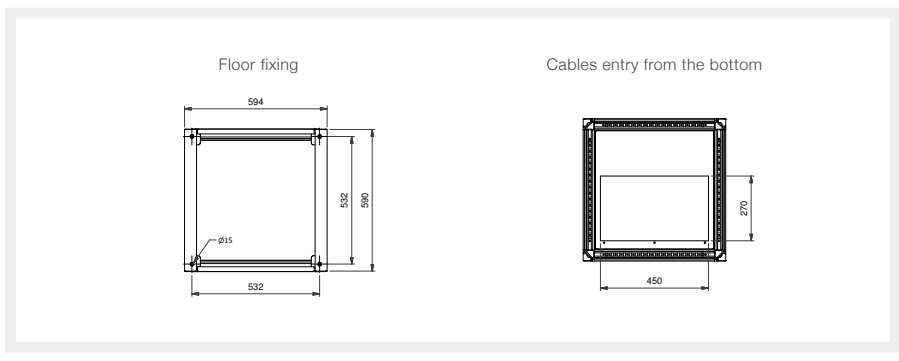

70

71

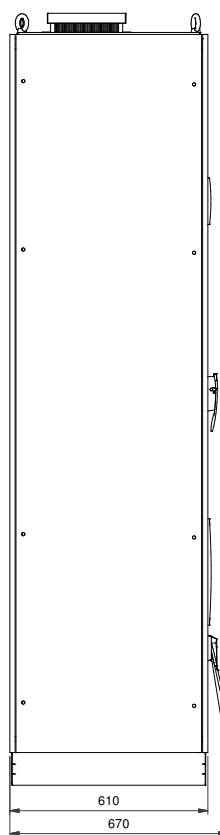
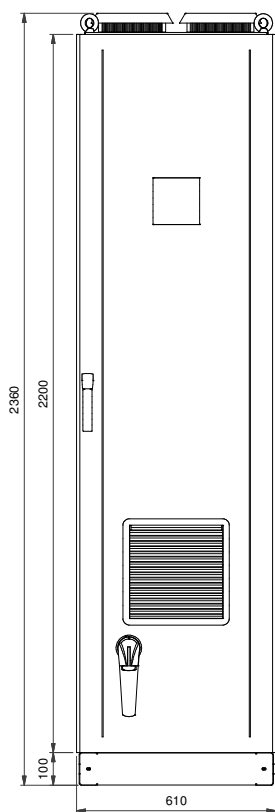

72

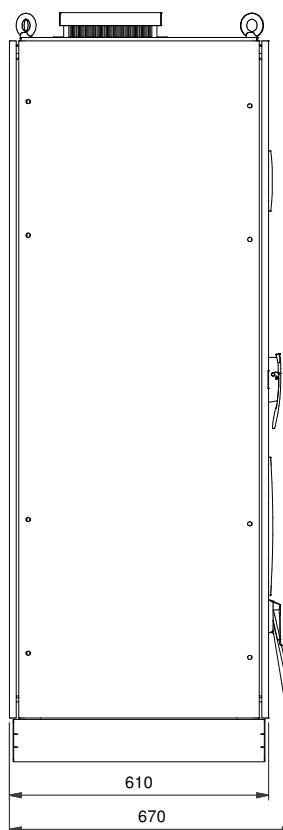
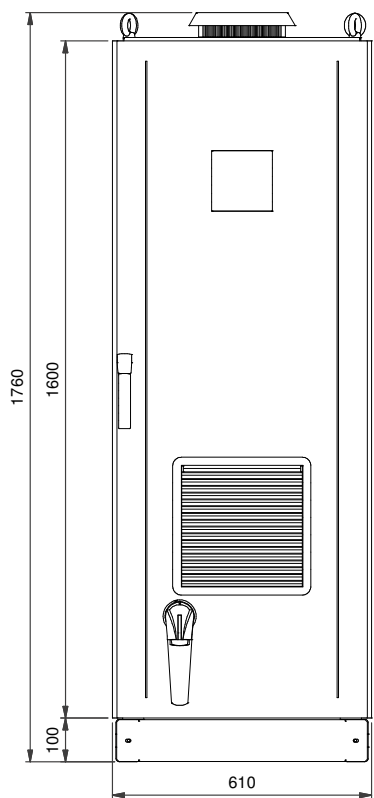



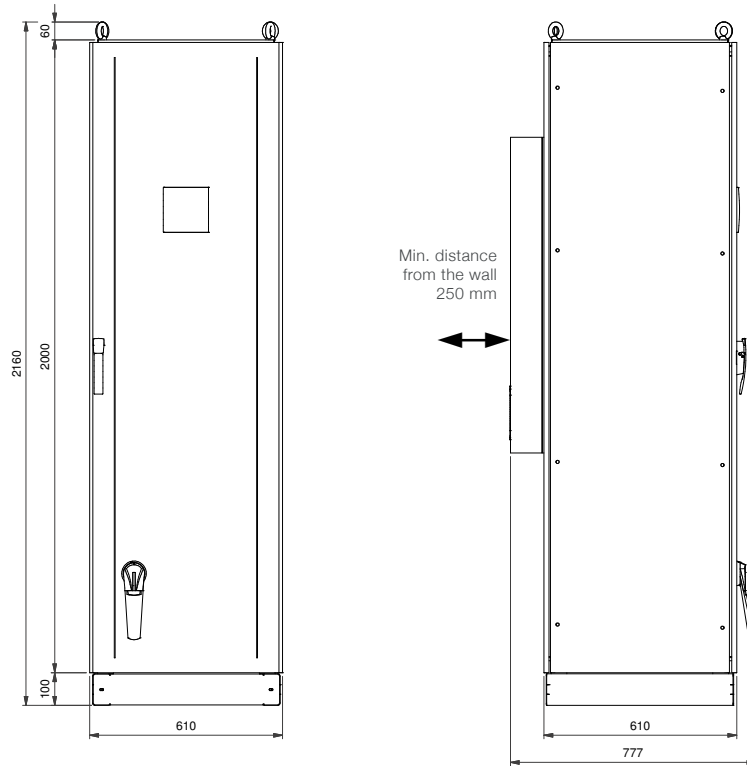

73

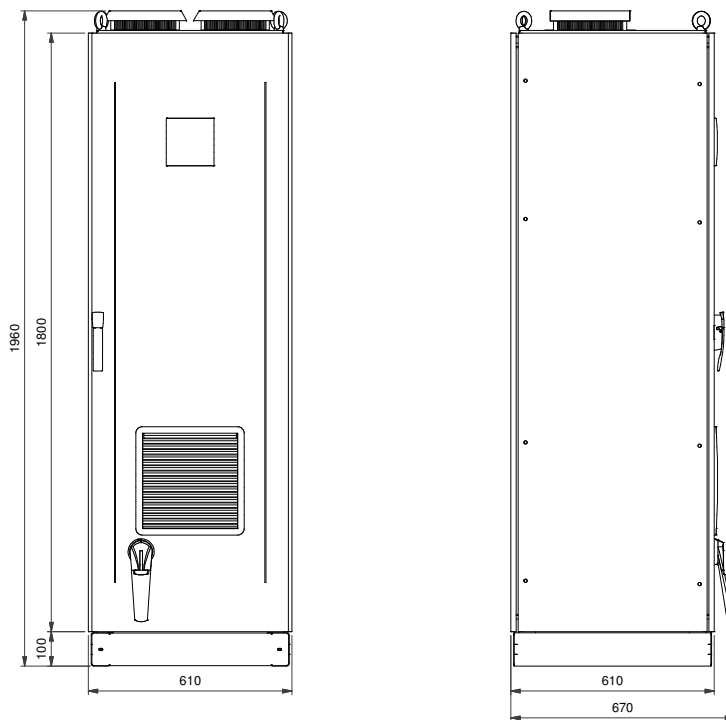

74

75

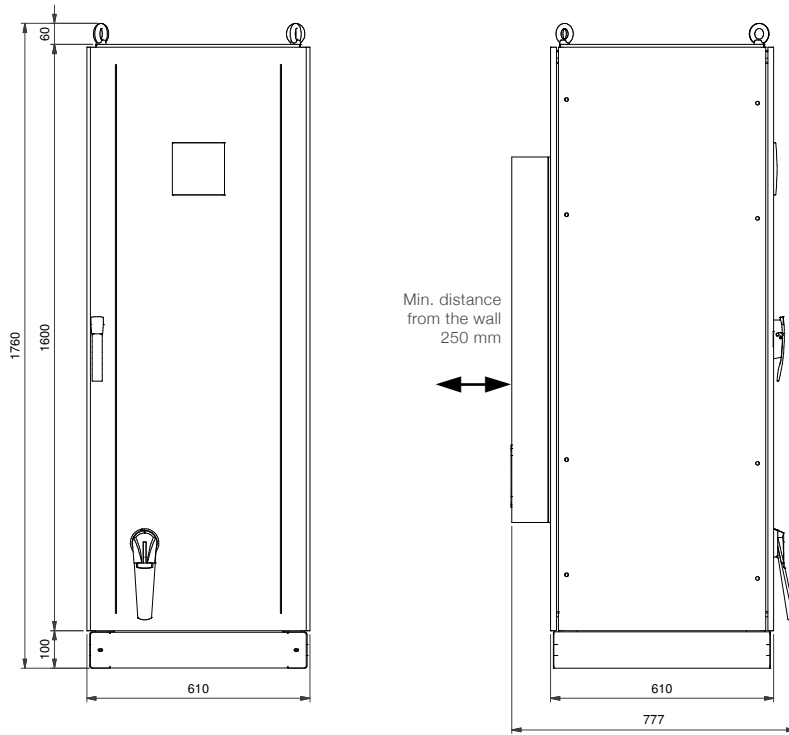

76

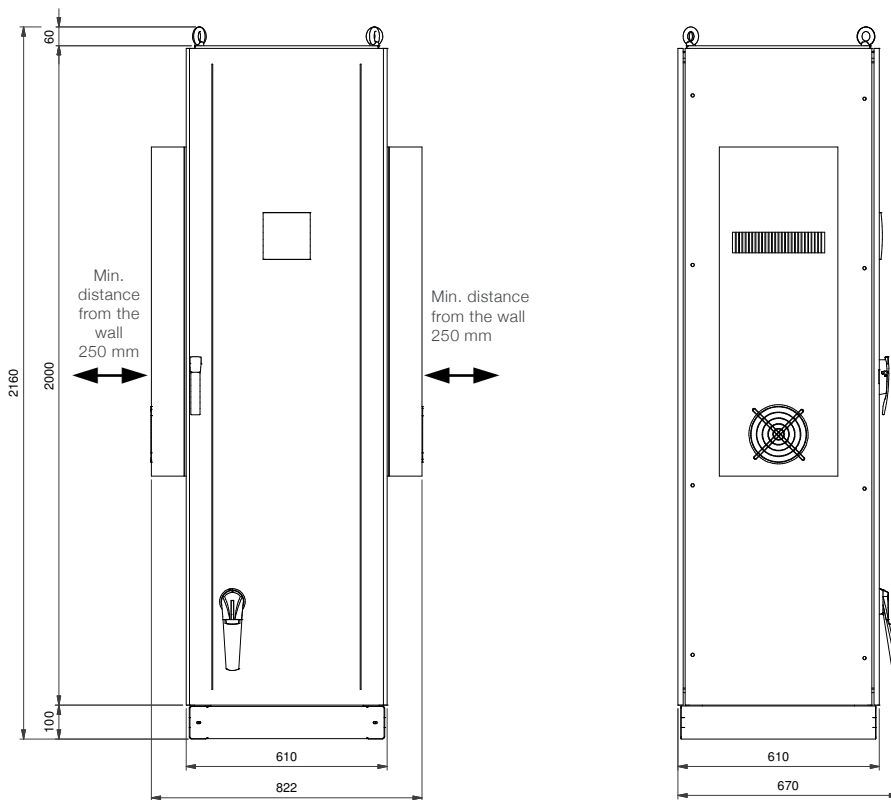

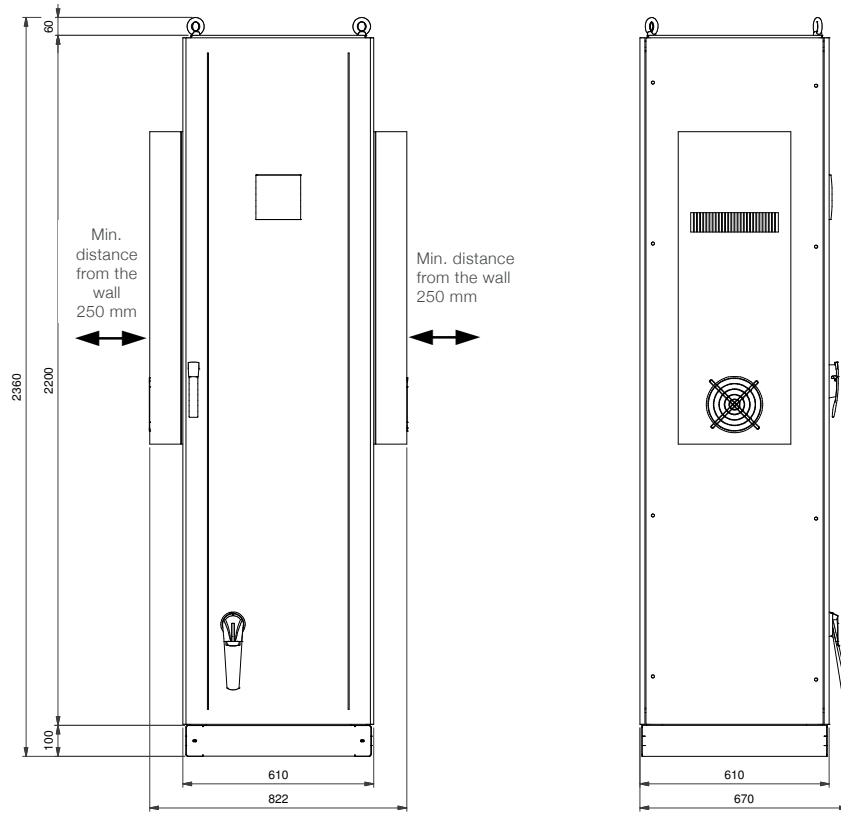

77

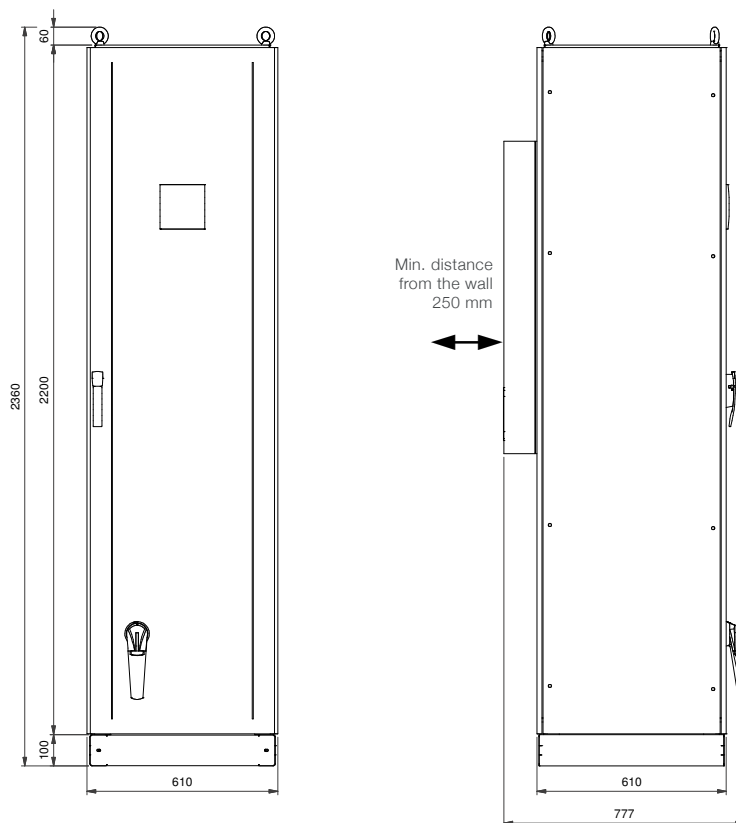

78

80

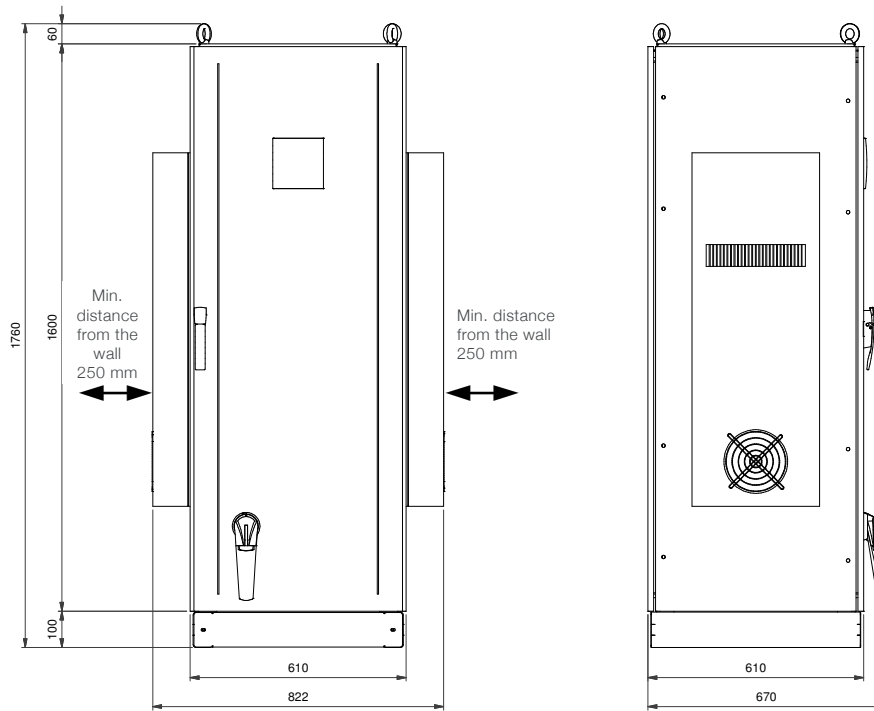

81

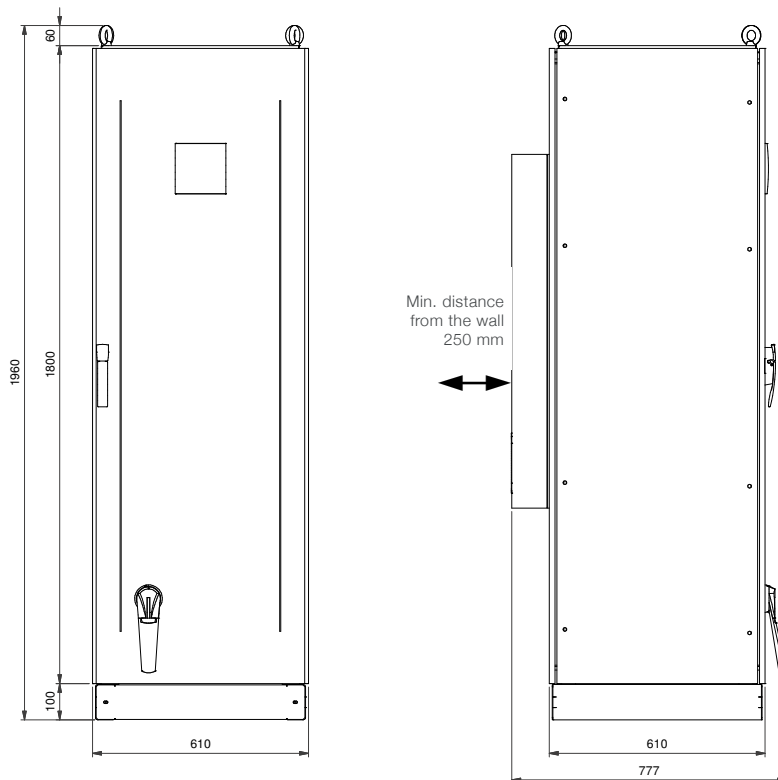

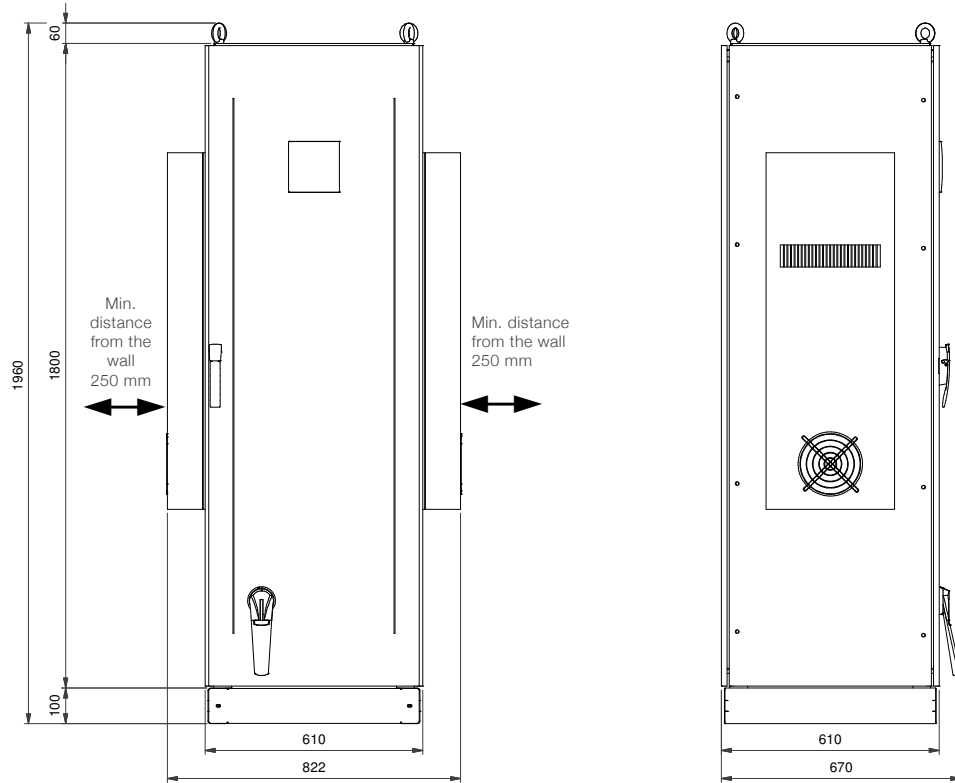

82

Applicable to drawings 83, 84, 85, 86, 90, 91, 92, 93, 94, 95, 96, 98

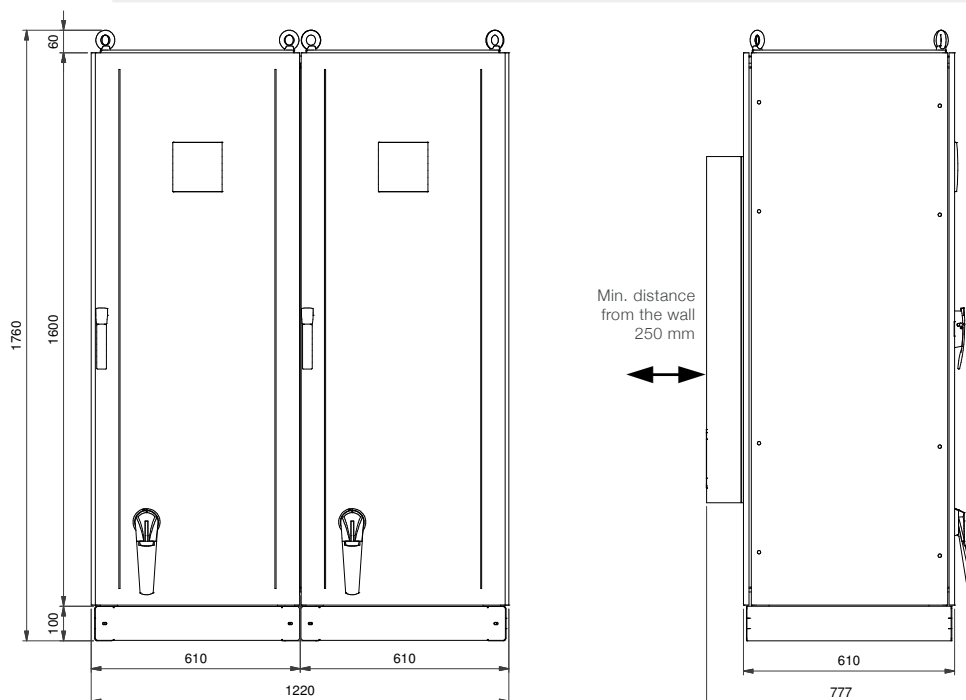
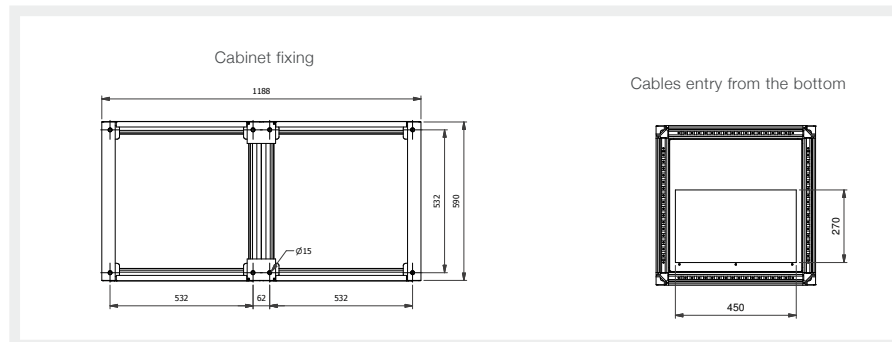

83

NB: I MULTImatic in due colonne hanno due sezionatori e necessitano di due ingressi cavo. Per versioni con unico ingresso cavi, consultateci

# DIMENSIONS

84

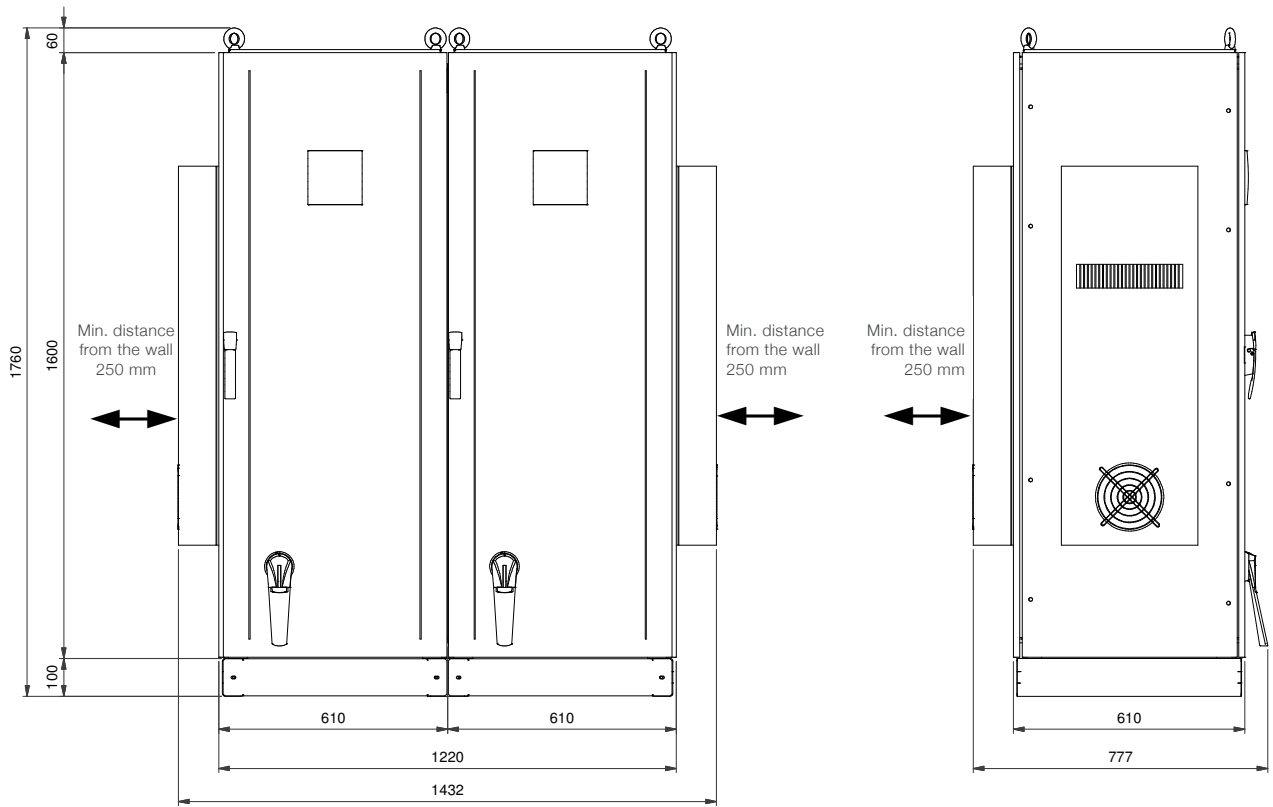

NB: I MULTImatic in due colonne hanno due sezionatori e necessitano di due ingressi cavo. Per versioni con unico ingresso cavi, consultateci

85

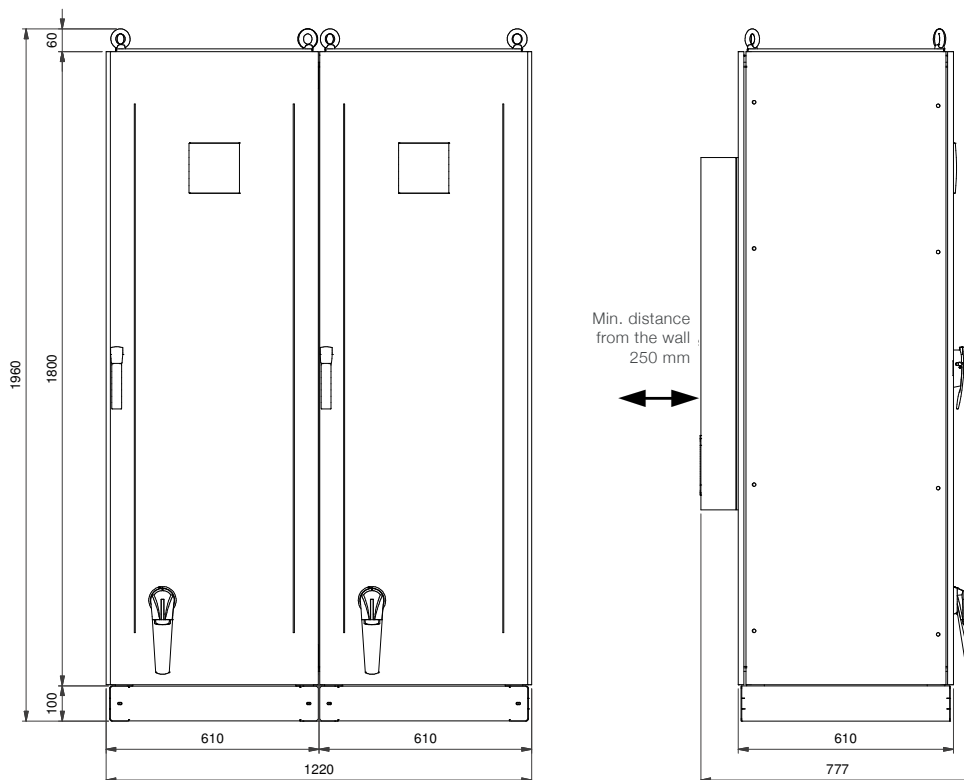

NB: I MULTImatic in due colonne hanno due sezionatori e necessitano di due ingressi cavo. Per versioni con unico ingresso cavi, consultateci

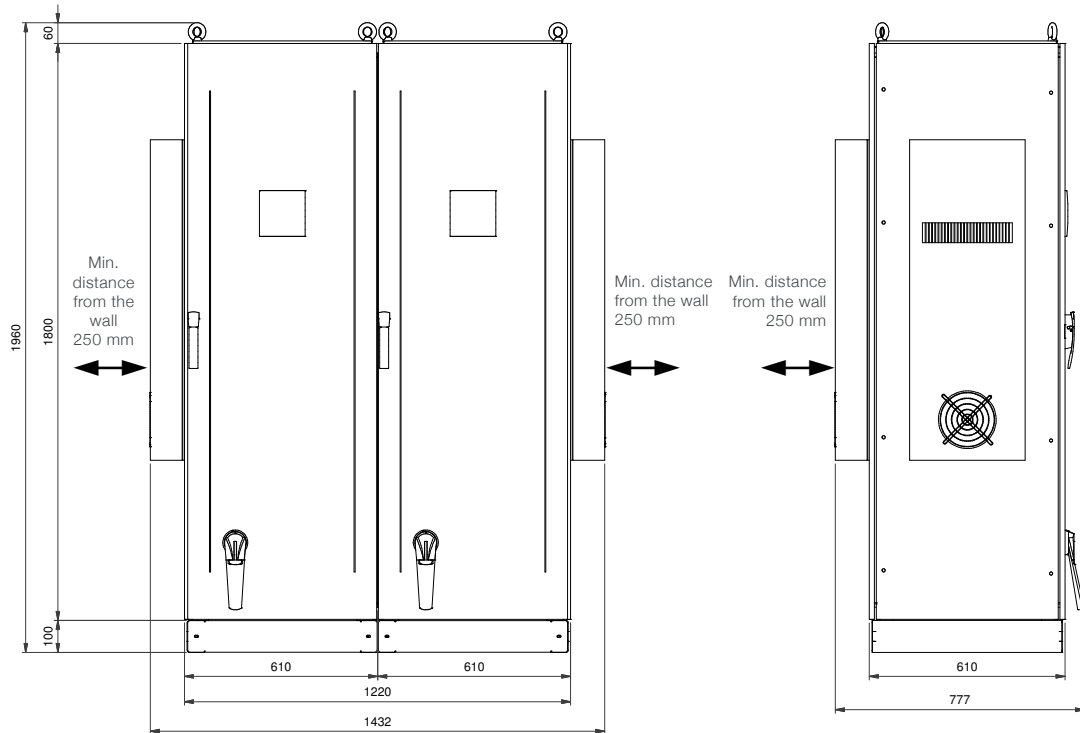

86

NB: I MULTimatic in due colonne hanno due sezionatori e necessitano di due ingressi cavo. Per versioni con unico ingresso cavi, consultateci

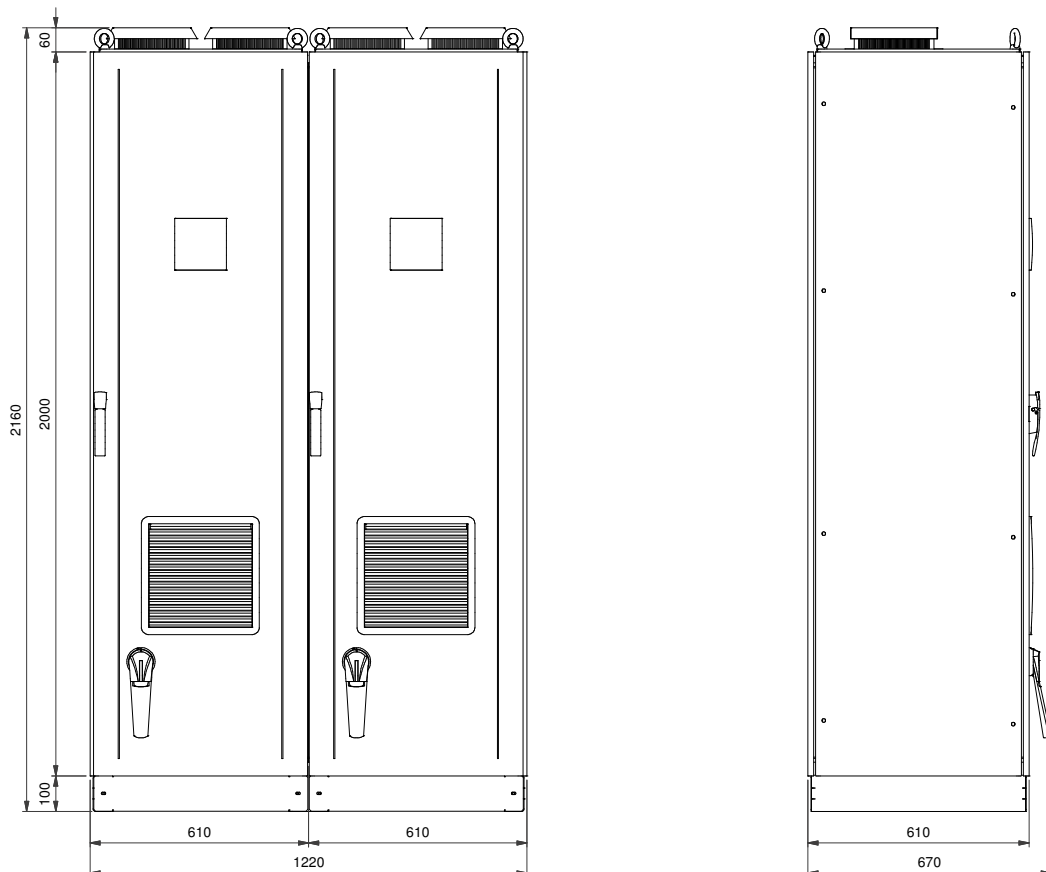

90

NB: I MULTimatic in due colonne hanno due sezionatori e necessitano di due ingressi cavo. Per versioni con unico ingresso cavi, consultateci

91

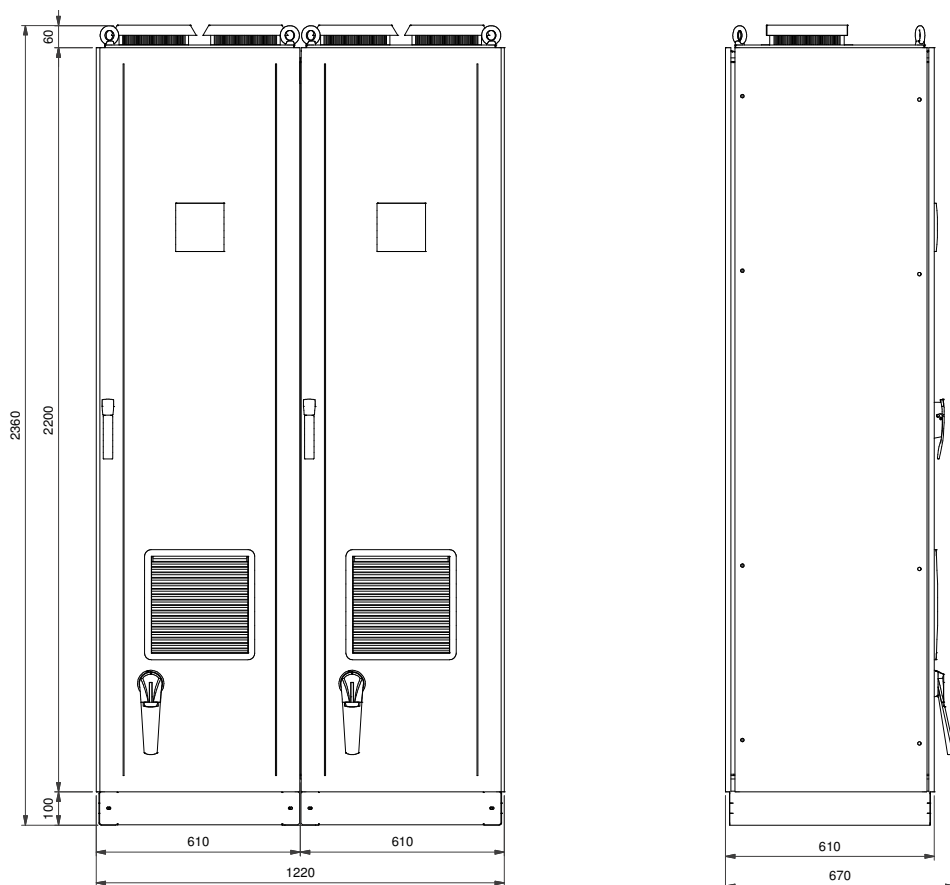

NB: I MULTImatic in due colonne hanno due sezionatori e necessitano di due ingressi cavo. Per versioni con unico ingresso cavi, consultateci

92

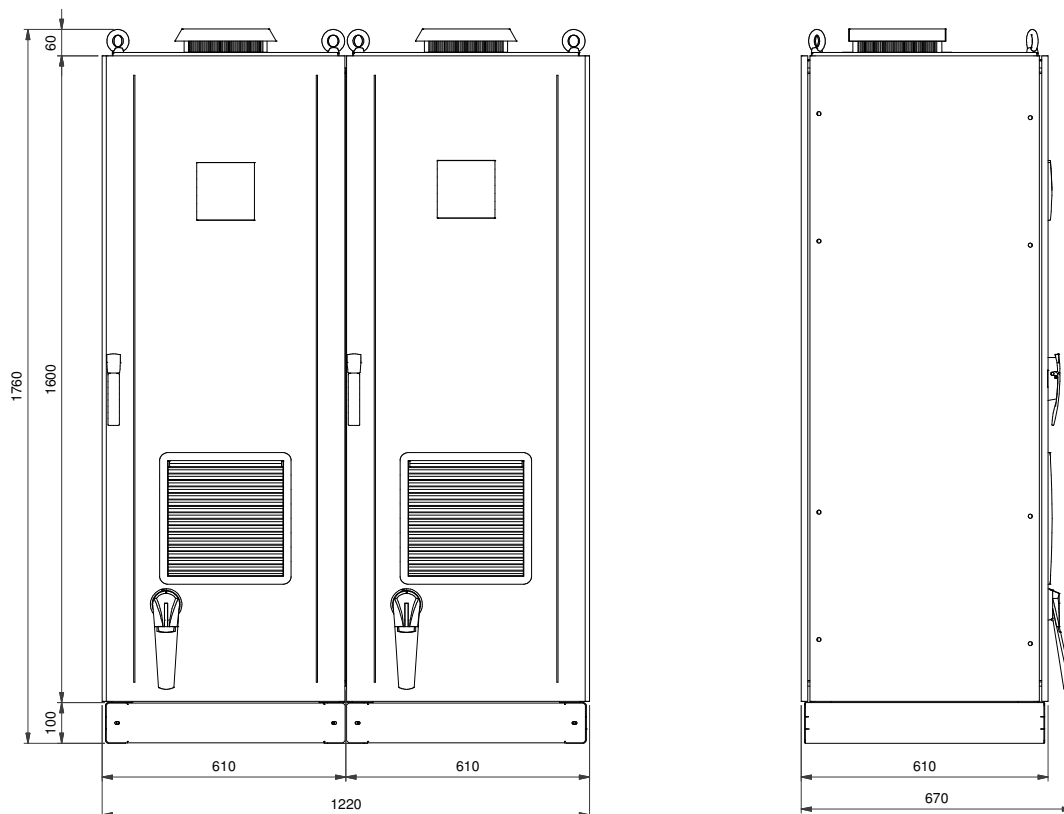

NB: I MULTImatic in due colonne hanno due sezionatori e necessitano di due ingressi cavo. Per versioni con unico ingresso cavi, consultateci



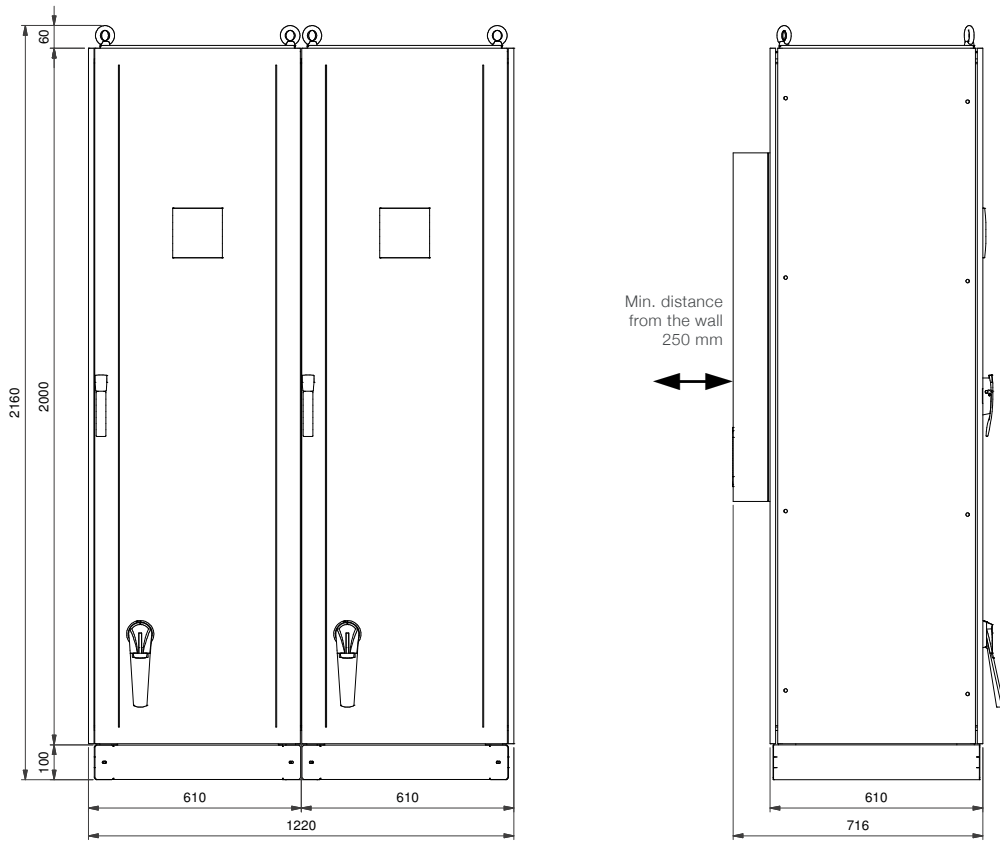

93

NB: I MULTImatic in due colonne hanno due sezionatori e necessitano di due ingressi cavo. Per versioni con unico ingresso cavi, consultateci

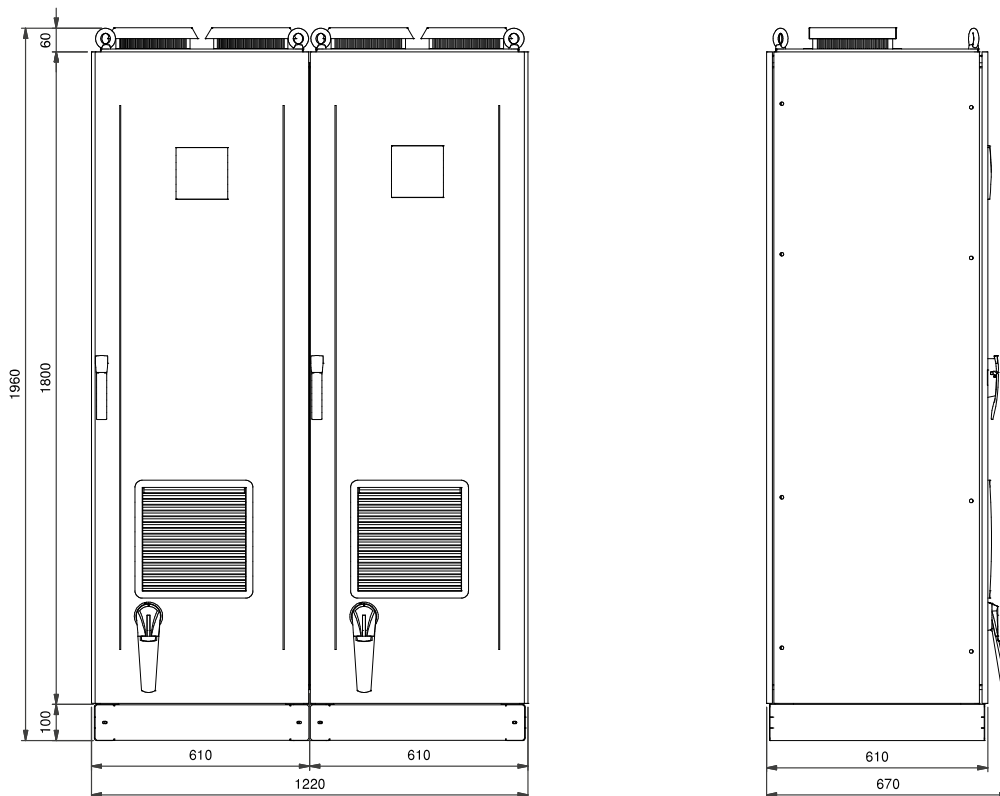

94

NB: I MULTImatic in due colonne hanno due sezionatori e necessitano di due ingressi cavo. Per versioni con unico ingresso cavi, consultateci

95

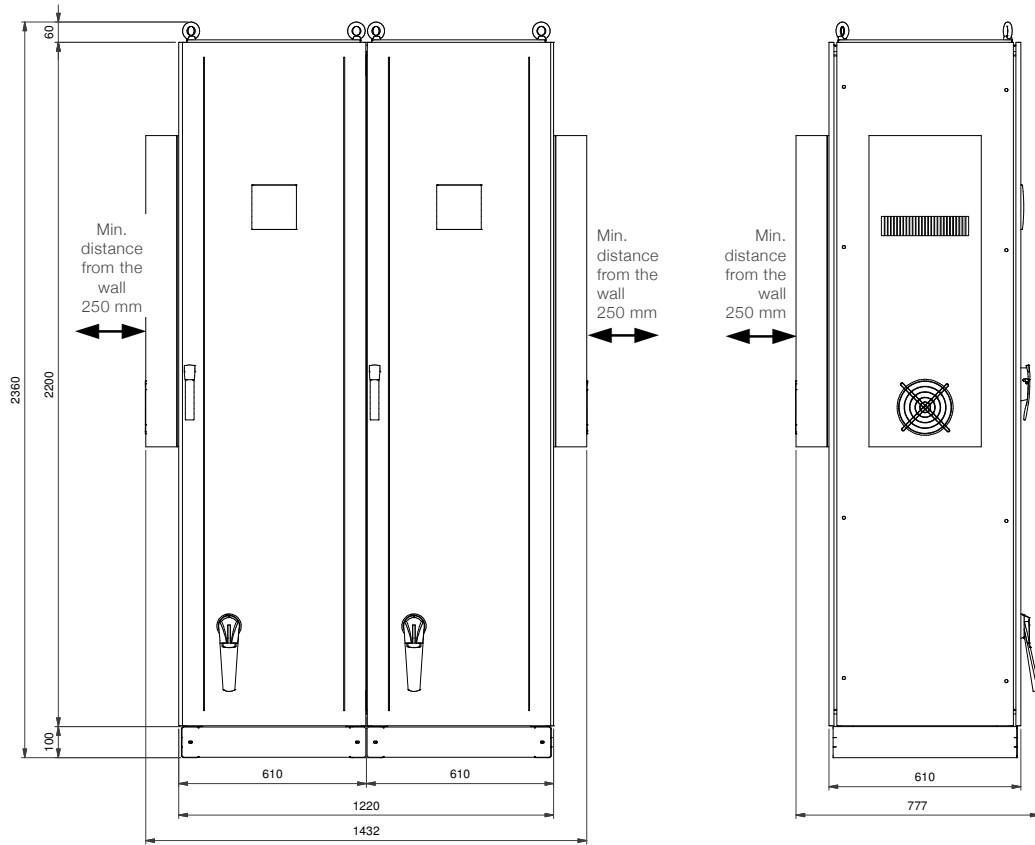

NB: I MULTImatic in due colonne hanno due sezionatori e necessitano di due ingressi cavo. Per versioni con unico ingresso cavi, consultateci

96

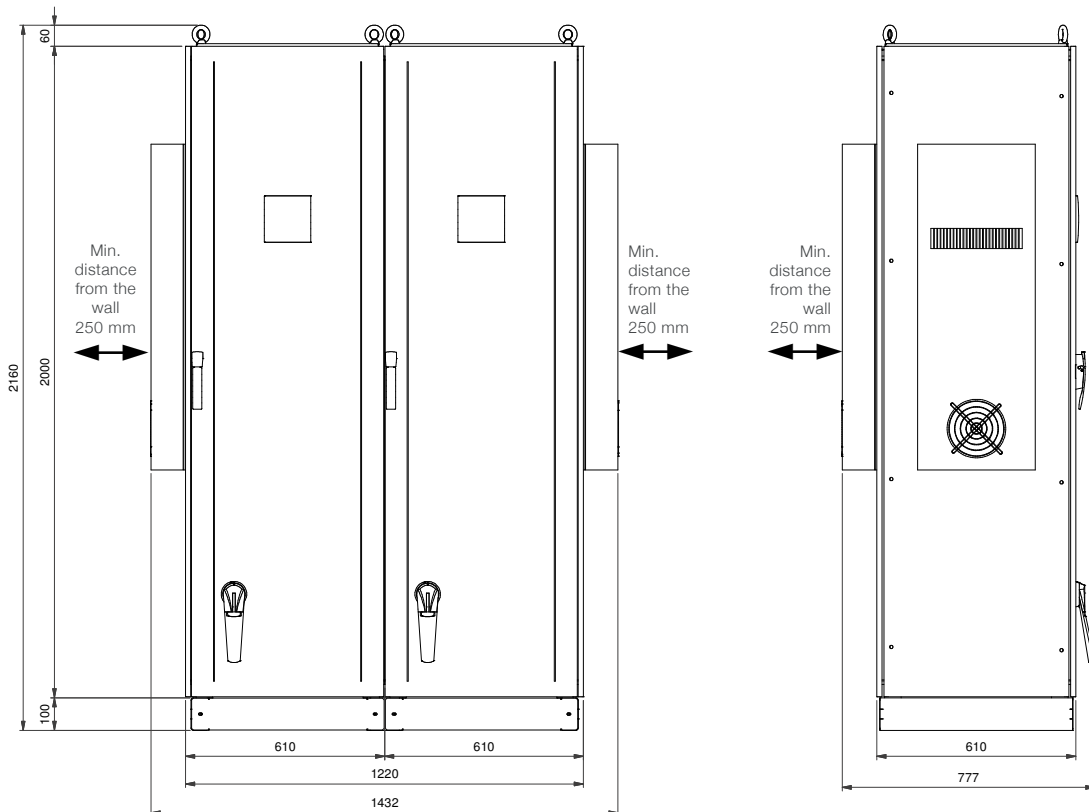

NB: I MULTImatic in due colonne hanno due sezionatori e necessitano di due ingressi cavo. Per versioni con unico ingresso cavi, consultateci

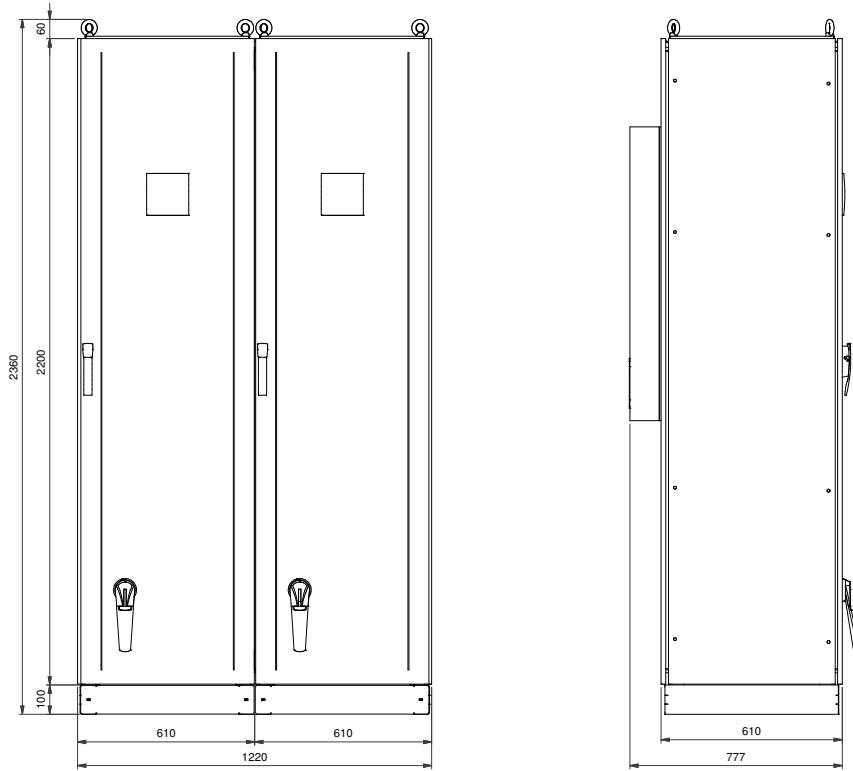

98

NB: I MULTImatic in due colonne hanno due sezionatori e necessitano di due ingressi cavo. Per versioni con unico ingresso cavi, consultateci

Applicable to drawings  
101, 102, 103, 104

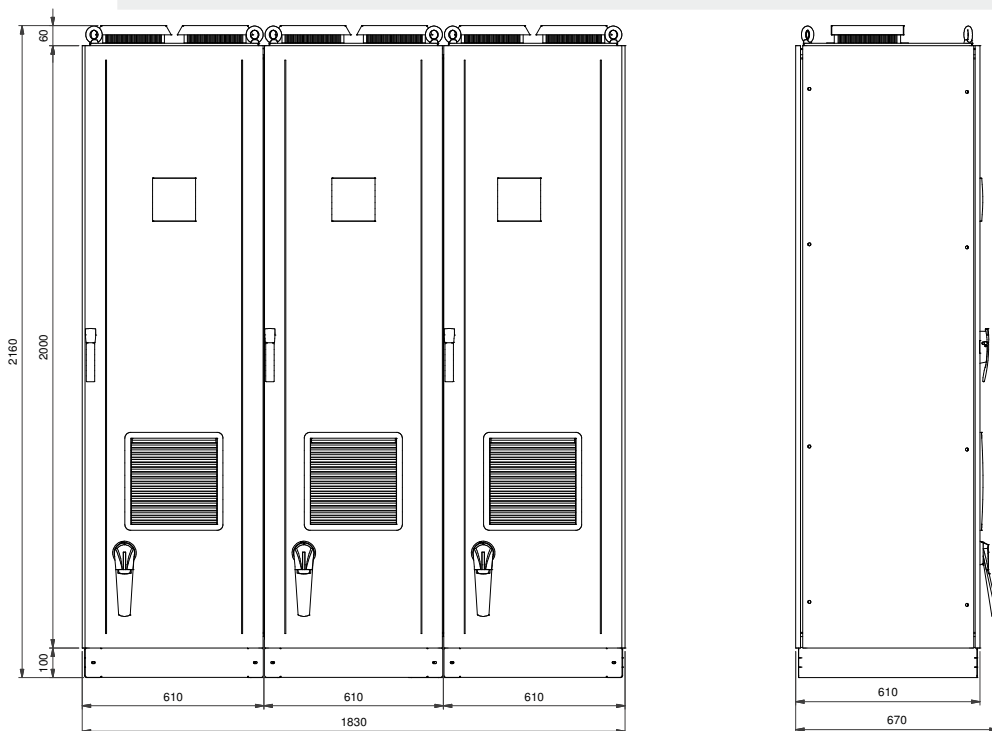
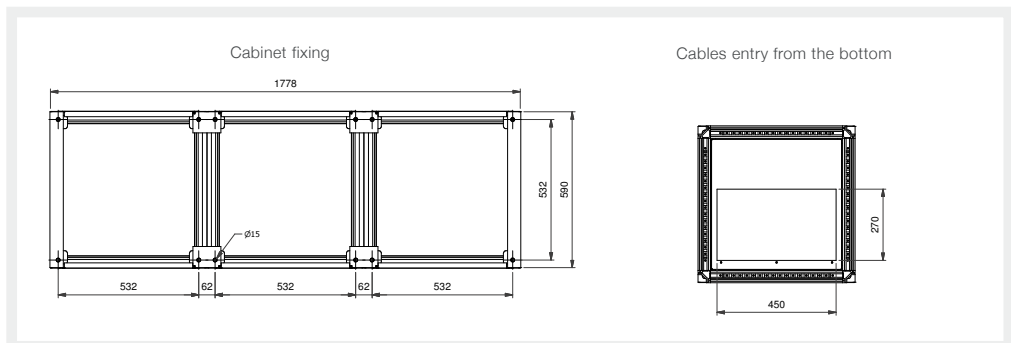

101

NB: I MULTImatic in tre colonne hanno due sezionatori e necessitano di tre ingressi cavo. Per versioni con unico ingresso cavi, consultateci

102

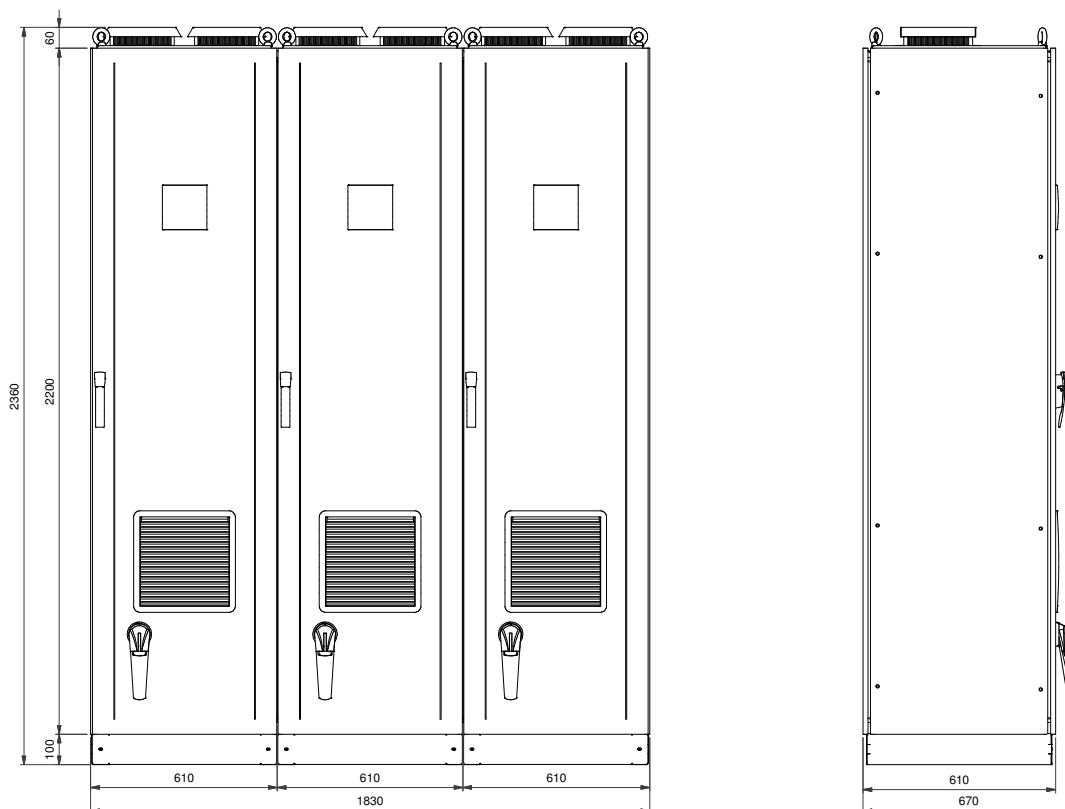

NB: I MULTImatic in tre colonne hanno tre sezionatori e necessitano di tre ingressi cavo. Per versioni con unico ingresso cavi, consultateci

103

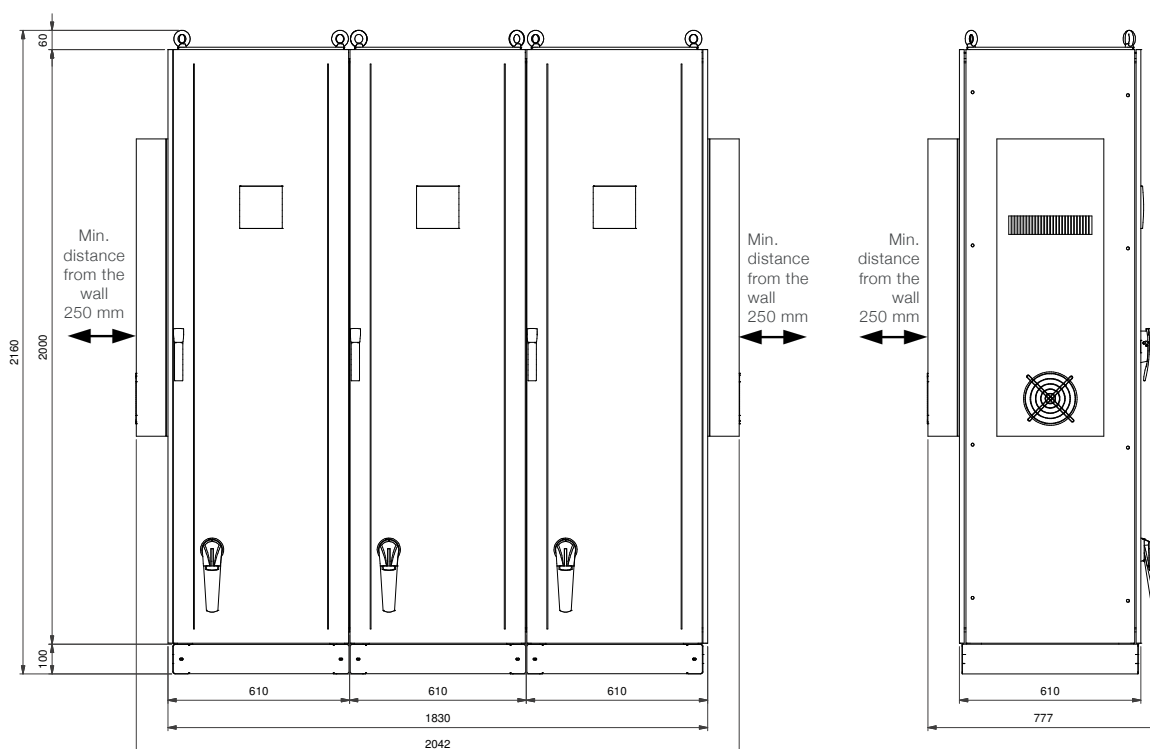

NB: I MULTImatic in tre colonne hanno tre sezionatori e necessitano di tre ingressi cavo. Per versioni con unico ingresso cavi, consultateci

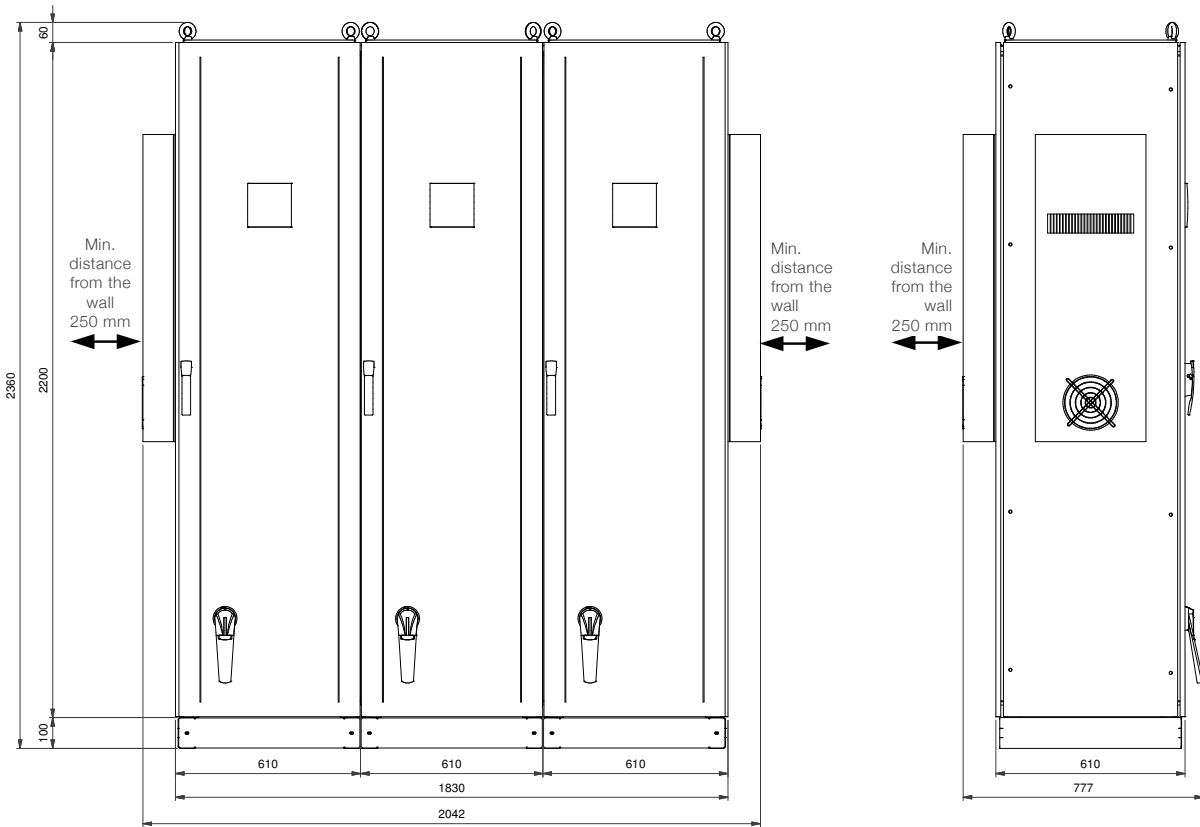

104

NB: I MULTImatic in tre colonne hanno tre sezionatori e necessitano di tre ingressi cavo. Per versioni con unico ingresso cavi, consultateci

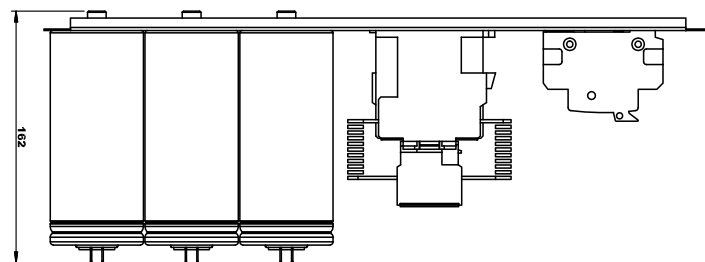
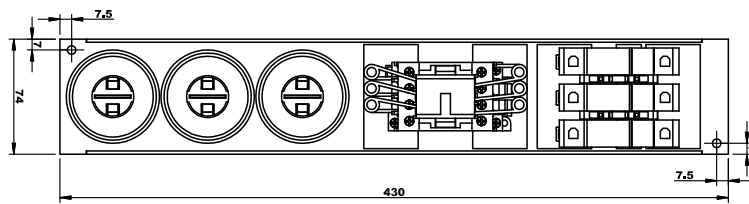

108

110

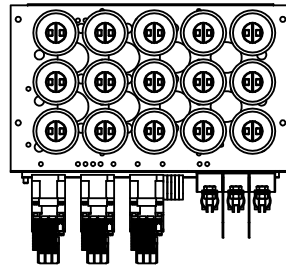
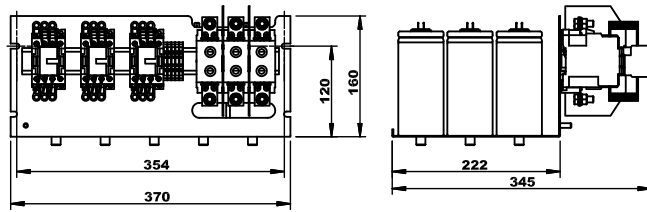

120

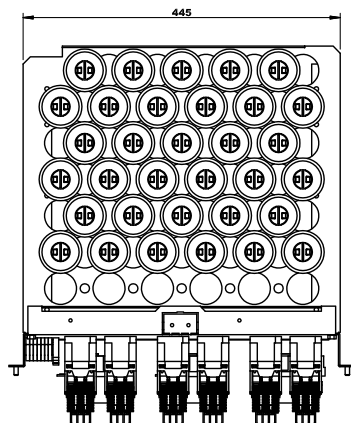
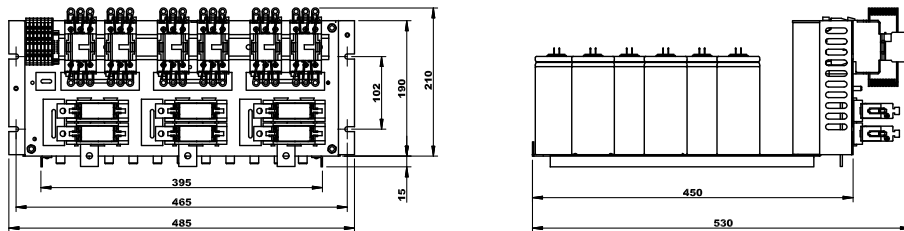

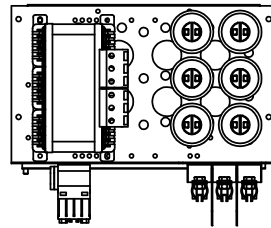
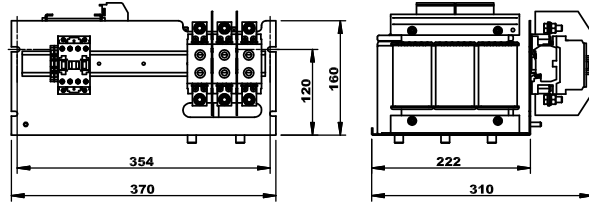
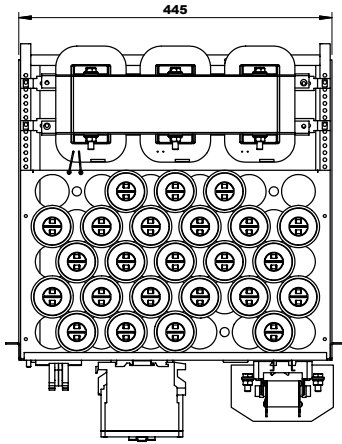
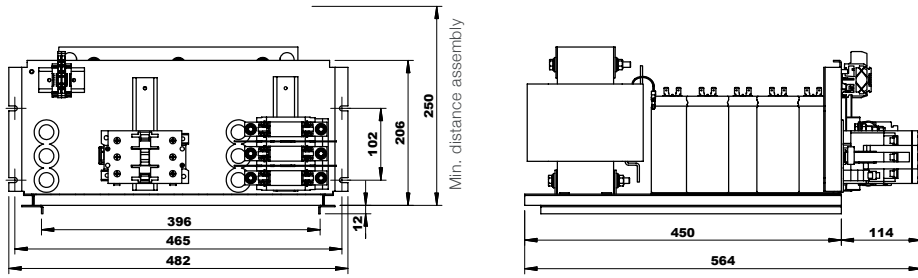

135

130

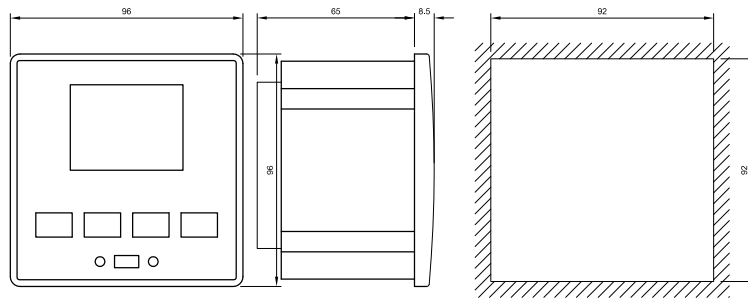

Overall dimensions

Depth

Drilling

144

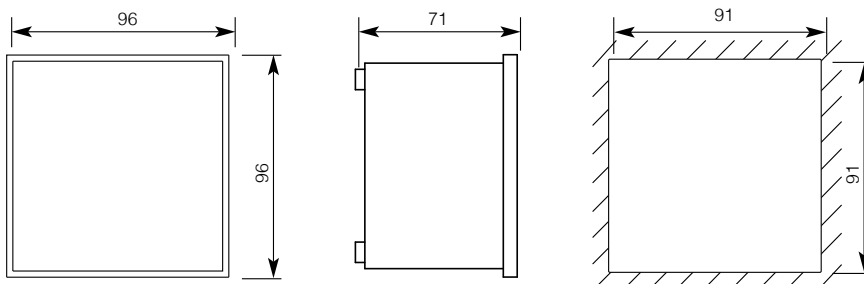

Overall dimensions

Depth

Drilling

145

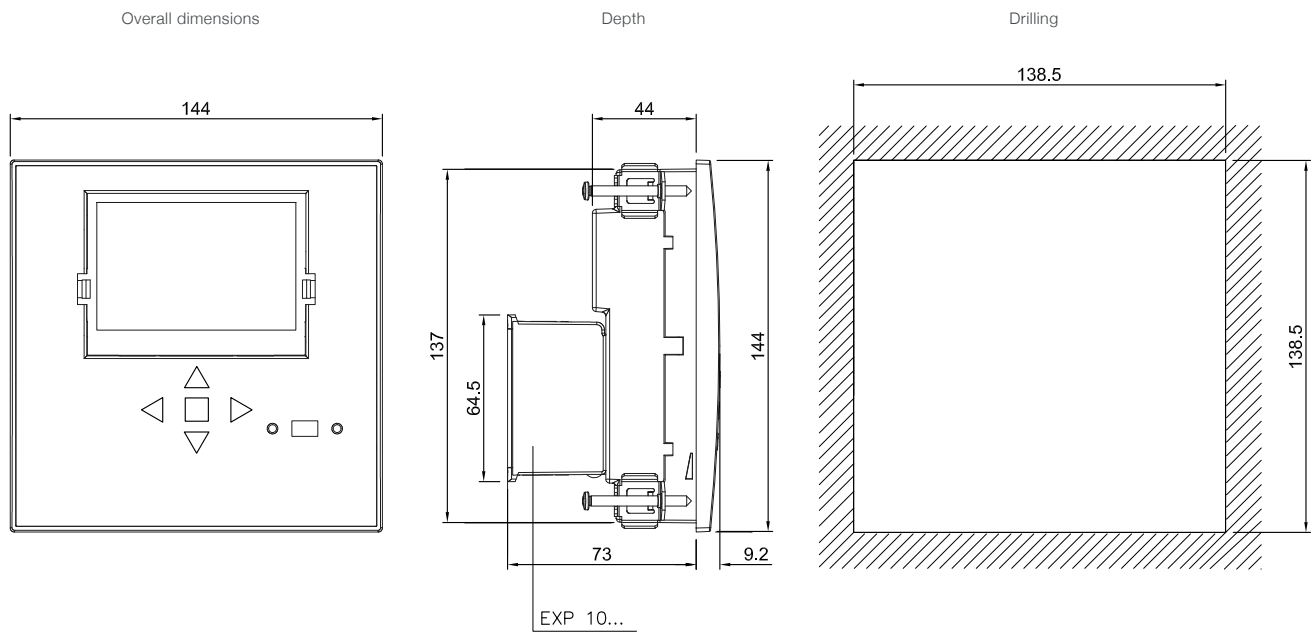

\* Con moduli posteriori aggiuntivi la profondità totale dietro portella è di 73mm

147



## APPENDIX

K factor for turning active power into reactive power to achieve target power factor.

Existing Power Factor	Target Power Factor									
	0,9	0,91	0,92	0,93	0,94	0,95	0,96	0,97	0,98	0,99
0,30	2,695	2,724	2,754	2,785	2,817	2,851	2,888	2,929	2,977	3,037
0,31	2,583	2,611	2,641	2,672	2,704	2,738	2,775	2,816	2,864	2,924
0,32	2,476	2,505	2,535	2,565	2,598	2,632	2,669	2,710	2,758	2,818
0,33	2,376	2,405	2,435	2,465	2,498	2,532	2,569	2,610	2,657	2,718
0,34	2,282	2,310	2,340	2,371	2,403	2,437	2,474	2,515	2,563	2,623
0,35	2,192	2,221	2,250	2,281	2,313	2,348	2,385	2,426	2,473	2,534
0,36	2,107	2,136	2,166	2,196	2,229	2,263	2,300	2,341	2,388	2,449
0,37	2,027	2,055	2,085	2,116	2,148	2,182	2,219	2,260	2,308	2,368
0,38	1,950	1,979	2,008	2,039	2,071	2,105	2,143	2,184	2,231	2,292
0,39	1,877	1,905	1,935	1,966	1,998	2,032	2,069	2,110	2,158	2,219
0,40	1,807	1,836	1,865	1,896	1,928	1,963	2,000	2,041	2,088	2,149
0,41	1,740	1,769	1,799	1,829	1,862	1,896	1,933	1,974	2,022	2,082
0,42	1,676	1,705	1,735	1,766	1,798	1,832	1,869	1,910	1,958	2,018
0,43	1,615	1,644	1,674	1,704	1,737	1,771	1,808	1,849	1,897	1,957
0,44	1,557	1,585	1,615	1,646	1,678	1,712	1,749	1,790	1,838	1,898
0,45	1,500	1,529	1,559	1,589	1,622	1,656	1,693	1,734	1,781	1,842
0,46	1,446	1,475	1,504	1,535	1,567	1,602	1,639	1,680	1,727	1,788
0,47	1,394	1,422	1,452	1,483	1,515	1,549	1,586	1,627	1,675	1,736
0,48	1,343	1,372	1,402	1,432	1,465	1,499	1,536	1,577	1,625	1,685
0,49	1,295	1,323	1,353	1,384	1,416	1,450	1,487	1,528	1,576	1,637
0,50	1,248	1,276	1,306	1,337	1,369	1,403	1,440	1,481	1,529	1,590
0,51	1,202	1,231	1,261	1,291	1,324	1,358	1,395	1,436	1,484	1,544
0,52	1,158	1,187	1,217	1,247	1,280	1,314	1,351	1,392	1,440	1,500
0,53	1,116	1,144	1,174	1,205	1,237	1,271	1,308	1,349	1,397	1,458
0,54	1,074	1,103	1,133	1,163	1,196	1,230	1,267	1,308	1,356	1,416
0,55	1,034	1,063	1,092	1,123	1,156	1,190	1,227	1,268	1,315	1,376
0,56	0,995	1,024	1,053	1,084	1,116	1,151	1,188	1,229	1,276	1,337
0,57	0,957	0,986	1,015	1,046	1,079	1,113	1,150	1,191	1,238	1,299
0,58	0,920	0,949	0,979	1,009	1,042	1,076	1,113	1,154	1,201	1,262
0,59	0,884	0,913	0,942	0,973	1,006	1,040	1,077	1,118	1,165	1,226
0,60	0,849	0,878	0,907	0,938	0,970	1,005	1,042	1,083	1,130	1,191
0,61	0,815	0,843	0,873	0,904	0,936	0,970	1,007	1,048	1,096	1,157
0,62	0,781	0,810	0,839	0,870	0,903	0,937	0,974	1,015	1,062	1,123
0,63	0,748	0,777	0,807	0,837	0,870	0,904	0,941	0,982	1,030	1,090
0,64	0,716	0,745	0,775	0,805	0,838	0,872	0,909	0,950	0,998	1,058
0,65	0,685	0,714	0,743	0,774	0,806	0,840	0,877	0,919	0,966	1,027
0,66	0,654	0,683	0,712	0,743	0,775	0,810	0,847	0,888	0,935	0,996
0,67	0,624	0,652	0,682	0,713	0,745	0,779	0,816	0,857	0,905	0,966
0,68	0,594	0,623	0,652	0,683	0,715	0,750	0,787	0,828	0,875	0,936
0,69	0,565	0,593	0,623	0,654	0,686	0,720	0,757	0,798	0,846	0,907
0,70	0,536	0,565	0,594	0,625	0,657	0,692	0,729	0,770	0,817	0,878
0,71	0,508	0,536	0,566	0,597	0,629	0,663	0,700	0,741	0,789	0,849
0,72	0,480	0,508	0,538	0,569	0,601	0,635	0,672	0,713	0,761	0,821
0,73	0,452	0,481	0,510	0,541	0,573	0,608	0,645	0,686	0,733	0,794
0,74	0,425	0,453	0,483	0,514	0,546	0,580	0,617	0,658	0,706	0,766
0,75	0,398	0,426	0,456	0,487	0,519	0,553	0,590	0,631	0,679	0,739
0,76	0,371	0,400	0,429	0,460	0,492	0,526	0,563	0,605	0,652	0,713
0,77	0,344	0,373	0,403	0,433	0,466	0,500	0,537	0,578	0,626	0,686
0,78	0,318	0,347	0,376	0,407	0,439	0,474	0,511	0,552	0,599	0,660
0,79	0,292	0,320	0,350	0,381	0,413	0,447	0,484	0,525	0,573	0,634
0,80	0,266	0,294	0,324	0,355	0,387	0,421	0,458	0,499	0,547	0,608
0,81	0,240	0,268	0,298	0,329	0,361	0,395	0,432	0,473	0,521	0,581
0,82	0,214	0,242	0,272	0,303	0,335	0,369	0,406	0,447	0,495	0,556
0,83	0,188	0,216	0,246	0,277	0,309	0,343	0,380	0,421	0,469	0,530
0,84	0,162	0,190	0,220	0,251	0,283	0,317	0,354	0,395	0,443	0,503
0,85	0,135	0,164	0,194	0,225	0,257	0,291	0,328	0,369	0,417	0,477
0,86	0,109	0,138	0,167	0,198	0,230	0,265	0,302	0,343	0,390	0,451
0,87	0,082	0,111	0,141	0,172	0,204	0,238	0,275	0,316	0,364	0,424
0,88	0,055	0,084	0,114	0,145	0,177	0,211	0,248	0,289	0,337	0,397
0,89	0,028	0,057	0,086	0,117	0,149	0,184	0,221	0,262	0,309	0,370
0,90	-	0,029	0,058	0,089	0,121	0,156	0,193	0,234	0,281	0,342
0,91	-	-	0,030	0,060	0,093	0,127	0,164	0,205	0,253	0,313
0,92	-	-	-	0,031	0,063	0,097	0,134	0,175	0,223	0,284
0,93	-	-	-	-	0,032	0,067	0,104	0,145	0,192	0,253
0,94	-	-	-	-	-	0,034	0,071	0,112	0,160	0,220
0,95	-	-	-	-	-	-	0,037	0,078	0,126	0,186

MV/LV transformer No Load Power Factor.

Transformer Power kVA	Oil Transformer kvar	Cast Resin Transformer kvar
10	1	1,5
20	2	1,7
50	4	2
75	5	2,5
100	5	2,5
160	7	4
200	7,5	5
250	8	7,5
315	10	7,5
400	12,5	8
500	15	10
630	17,5	12,5
800	20	15
1000	25	17,5
1250	30	20
1600	35	22
2000	40	25
2500	50	35
3150	60	50

Three Phase Asynchronous Motors. Special care to self-excitation.

Motor Power		Reactive Power (kvar)				
HP	kW	3000 rpm	1500 rpm	1000 rpm	750 rpm	500 rpm
0,4	0,55	-	-	0,5	0,5	-
1	0,73	0,5	0,5	0,6	0,6	-
2	1,47	0,8	0,8	1	1	-
3	2,21	1	1	1,2	1,6	-
5	3,68	1,6	1,6	2	2,5	-
7	5,15	2	2	2,5	3	-
10	7,36	3	3	4	4	5
15	11	4	5	5	6	6
30	22,1	10	10	10	12	15
50	36,8	15	20	20	25	25
100	73,6	25	30	30	30	40
150	110	30	40	40	50	60
200	147	40	50	50	60	70
250	184	50	60	60	70	80

Typical Power Factor of few common loads.

	<b>cos phi</b>	
Office appliances (computers, printers, etc)		<b>0,7</b>
Fridges		<b>0,8</b>
Commercial mall		<b>0,85</b>
Office block		<b>0,8</b>
Extruders		<b>0,4÷0,7</b>
Resistor furnaces		<b>1</b>
Arc furnaces		<b>0,8</b>
Induction furnaces		<b>0,85</b>
Incandescent lamps		<b>1</b>
Discharge lamps		<b>0,4÷0,6</b>
Fluorescent lamps without integrated PFC		<b>0,5</b>
Fluorescent lamps with integrated PFC		<b>0,9÷0,93</b>
LED lamps without integrated PFC		<b>0,3÷0,6</b>
LED lamps with integrated PFC		<b>0,9÷0,95</b>
Asynchronous motor		
	<b>Load Factor</b>	
	<b>0</b>	<b>0,2</b>
	<b>25%</b>	<b>0,55</b>
	<b>50%</b>	<b>0,72</b>
	<b>75%</b>	<b>0,8</b>
	<b>100%</b>	<b>0,85</b>
Mechanical workshop		<b>0,6÷0,7</b>
Carpentry		<b>0,7÷0,8</b>
Hospital		<b>0,8</b>
Glassworks		<b>0,8</b>
Food appliances with VSD		<b>0,99</b>
Photovoltaic plants with site exchange		<b>0,1÷0,9</b>

[www.icar.com](http://www.icar.com)

On internet ICAR web you'll find,  
more information about PFC:

- **ANY NEWS**
- **REFERENCES**
- **ICAR SERVICES**
- **ALL DOCUMENTS FOR DOWNLOAD**
  - **manuals**
  - **catalogues and brochures**
  - **technical newsletters for**
    - quick installation guidelines
    - CT selection and positioning
    - Selection of PFC in case of photovoltaic plants
    - Selection and tuning of PFC upstream protections
    - Selection table for heavily polluted and resonance risk plants
    - Selection table for replacement of old controllers
    - Meaning of error messages and problem solving.

Similar information  
is available for  
MV Power Factor Correction



**ICAR S.p.A.**  
Via Isonzo, 10  
20900 Monza (MB) - Italy  
tel. +39 039 83.951  
fax +39 039 83.32.27  
[www.icar.com](http://www.icar.com)  
[sales@icar.com](mailto:sales@icar.com)



TECHNICAL FEATURES AND DIMENSIONS OF THIS CATALOGUE CAN BE CHANGED WITHOUT ICAR PRIOR NOTICE.  
ICAR DECLINES ANY RESPONSIBILITY FOR DAMAGES TO HUMANS OR OBJECTS FROM WRONG SELECTION OR USE OF ICAR MADE PRODUCTS.