

70m LONG DISTANCE

AC power driven photosensor

- Specifications are subject to change without prior notice.
- Specifications and technical information not mentioned here are written in Instruction Manual. Or visit our website for details.
- All the warnings and cautions to know prior to use are given in Instruction Manual.

OPTEX
FA **OPTEX FA CO., LTD.**

600-8815 Kyoto, Shimogyo, Chudoji Awata 91, Japan
TEL. +81-(0)75-325-2920 FAX. +81-(0)75-325-2921
<http://www.optex-fa.com>



Photoelectric Sensor V2 series



- BGS types with a rugged duty housing.
- Up to 100 cm sensing distance (BGS-2V100).
- The large lenses assure stable sensing.
- IP67, QD types are available.

Applications



Gate control (V2T-7000)

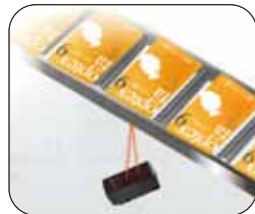

Magazines on roller conveyor (BGS-2V50)



Parking control (V2T-7000)



Tire counting (V2R-1200)

A large projecting and receiving lens results in a strong projected beam. Ideal for use in tough conditions like a foggy atmosphere.



Only 1 cm of dead area (Retro-reflective types)



Connector can be rotated for added flexibility when mounting. (DC Power type)

The connector rotates 90 degrees for added flexibility when mounting. IP67 is maintained even with the connector.



Circuit diagram

AC/DC type

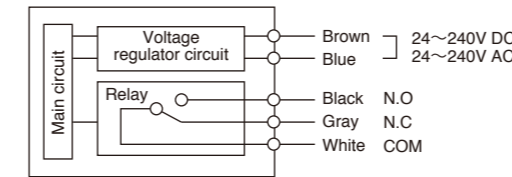

DC Emitter

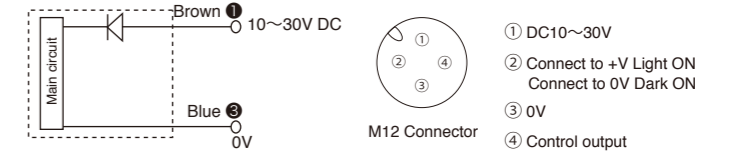

DC NPN type

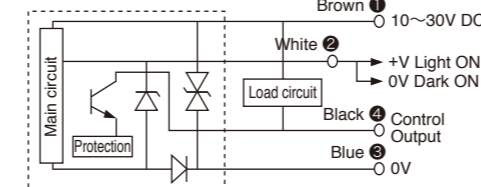

DC PNP type

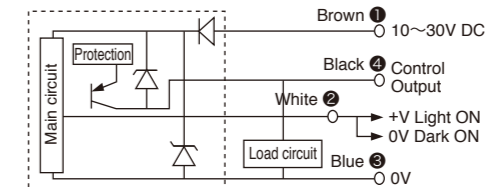

Dimensions

Cable type

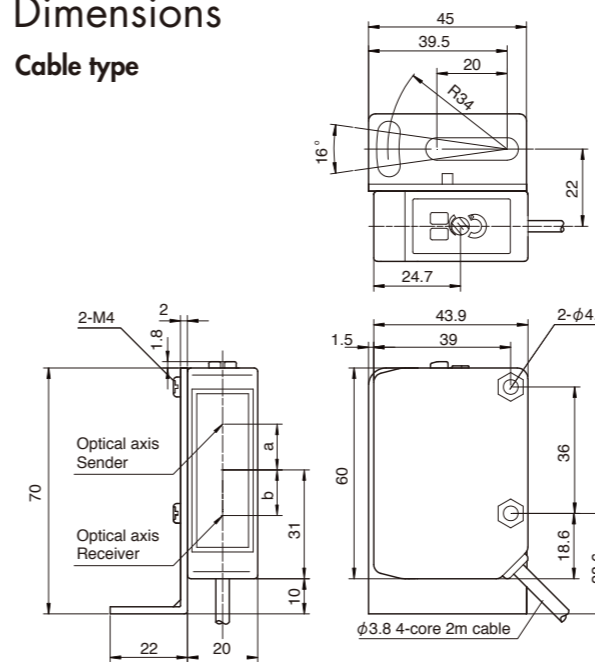

	BGS-2V	V2R-1200	V2T-7000
a	13	16.8	44
b	BGS Short 12.6 / mid 13 / long 13.6	19	-

Connector type

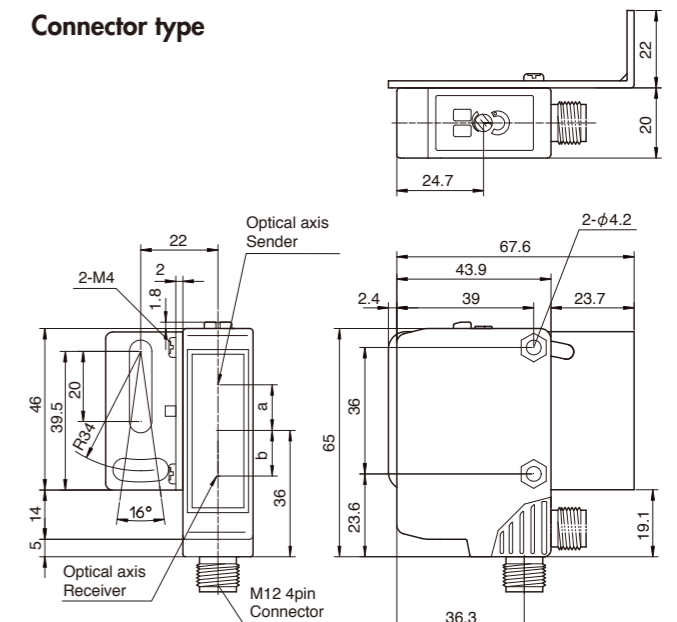

	BGS-2V	V2R-1200	V2T-7000
a	13	16.8	49
b	BGS Short 12.6 / mid 13 / long 13.6	24	-

Specifications

Model	V2 series AC/DC type					V2 series DC type				
	Thru-beam	Retro-reflective (polarized filter)	BGS			Thru-beam	Retro-reflective (polarized filter)	BGS		
			Long range	Middle range	Short range			Long range	Middle range	Short range
Cable type	V2T-7000	V2R-1200	BGS-2V100	BGS-2V50	BGS-2V30	V2T-7000D(N,P)	V2R-1200D(N,P)	BGS-2V100(N,P)	BGS-2V50(N,P)	BGS-2V30(N,P)
Connector type	—	—	—	—	—	V2T-7000CD(N,P)	V2R-1200CD(N,P)	BGS-2V100C(N,P)	BGS-2V50C(N,P)	BGS-2V30C(N,P)
Detecting distance	70m	0.01~12m*1	25~100cm	15~50cm	10~30cm	70m	0.01~12m*1	25~100cm	15~50cm	10~30cm
Light source	Red LED									
Supply voltage	DC24~240V±10% AC24~240V±10% 50/60Hz					DC10~30V Including ripple (P-P)10%				
Current consumption	3VA max.(class A) 2VA max.(class A) 4VA max.(class B) 2.5VA max.(class B)					35mA max.				
Response time	15ms max.					0.5ms max.		3ms max.		2ms max.
Hysteresis	—					—		15% max.		5% max.
Control output	Relay 1C DC30V 2A / AC250V 3A max.					NPN/PNP open collector DC30V 100mA max. (Residual voltage 1.8V max)				
Operation mode	Light ON					Light ON / Dark ON selectable by wiring				
Sensitivity adjustment	2 rotation volume									
Indicator	Output indicator (orange LED) / Stable indicator (green LED)									
Ambient temp./humidity	-25~55°C / 35~85%RH (No condensation of freezing)									
Storage temp./humidity	-40~70°C / 35~95%RH									
Environmental illuminance	Sun light:10000 lx max. Incandescent light:3000 lx max.									
Protection category/material	IP67 (IEC 144)/Case: ABS (Glass fiber include) Front cover : PC (PMMA for retro-ref.type)									

*1 Reflector V-61

EXCESS GAIN

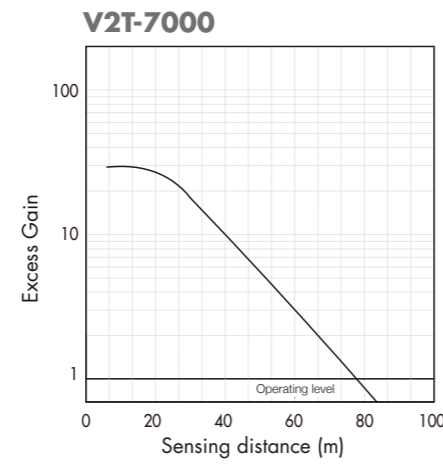
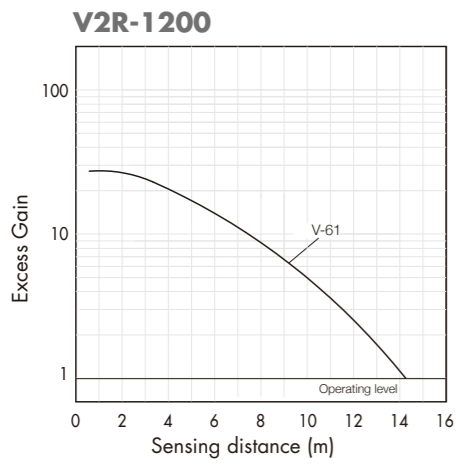

INTERFERENCE AREA

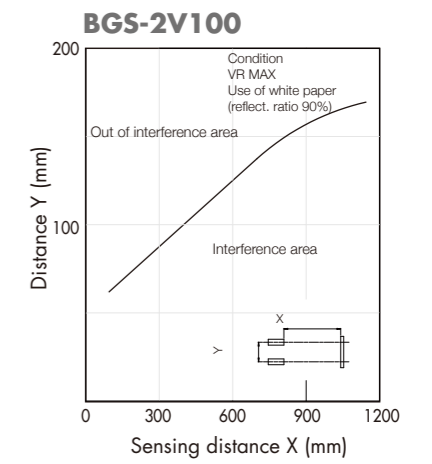
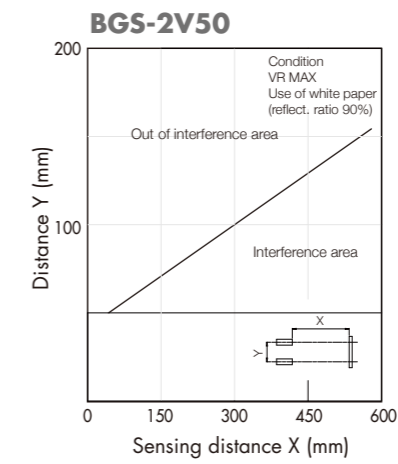
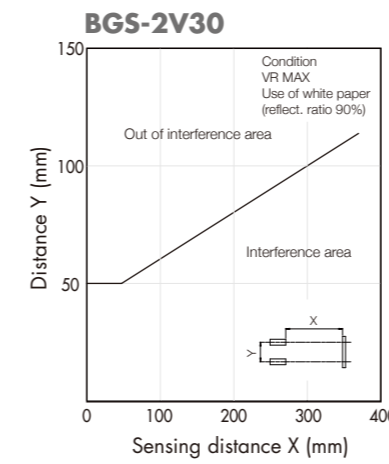

SENSING AREA

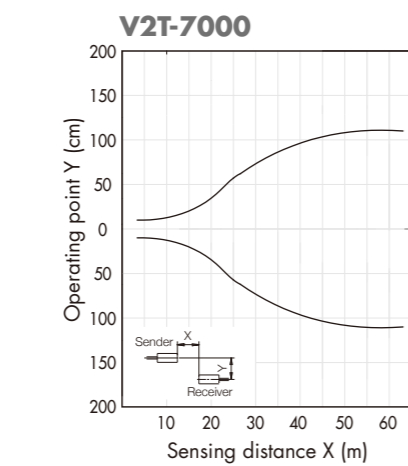
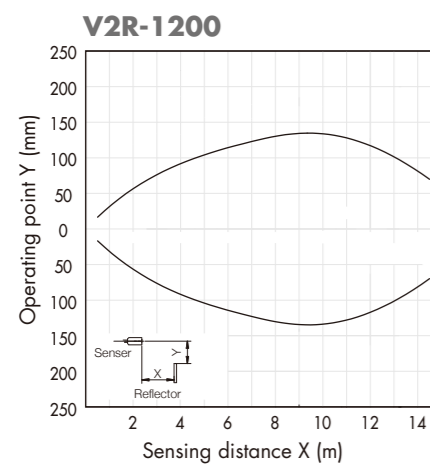
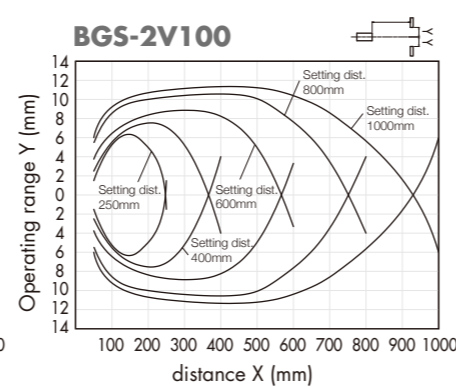
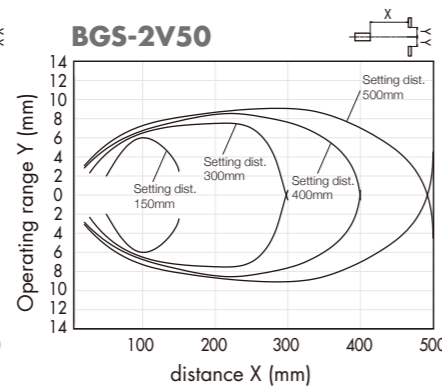
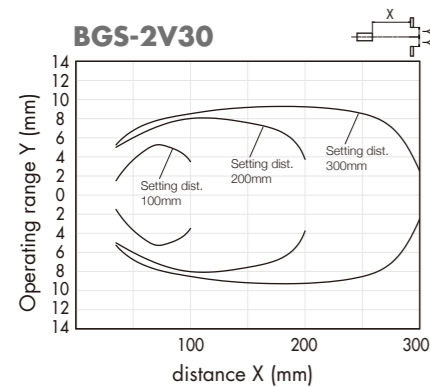

SPOT SIZE

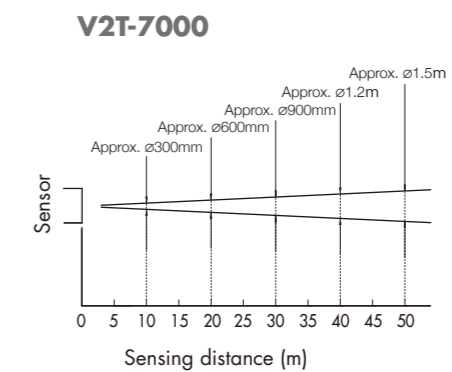
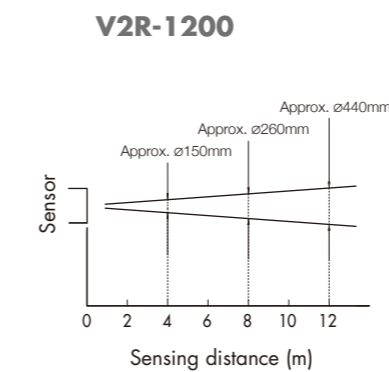
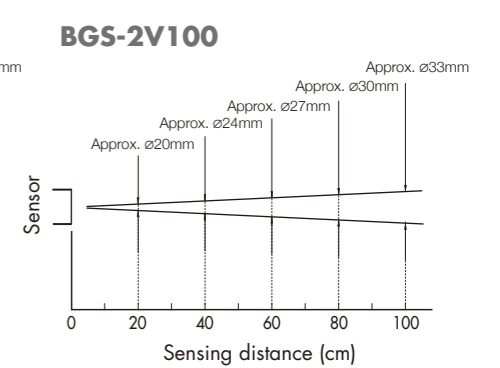
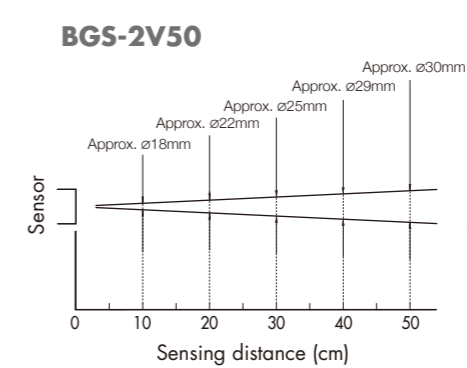
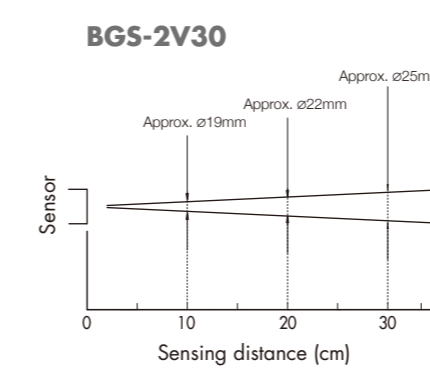

MATERIAL CHARACTERISTICS

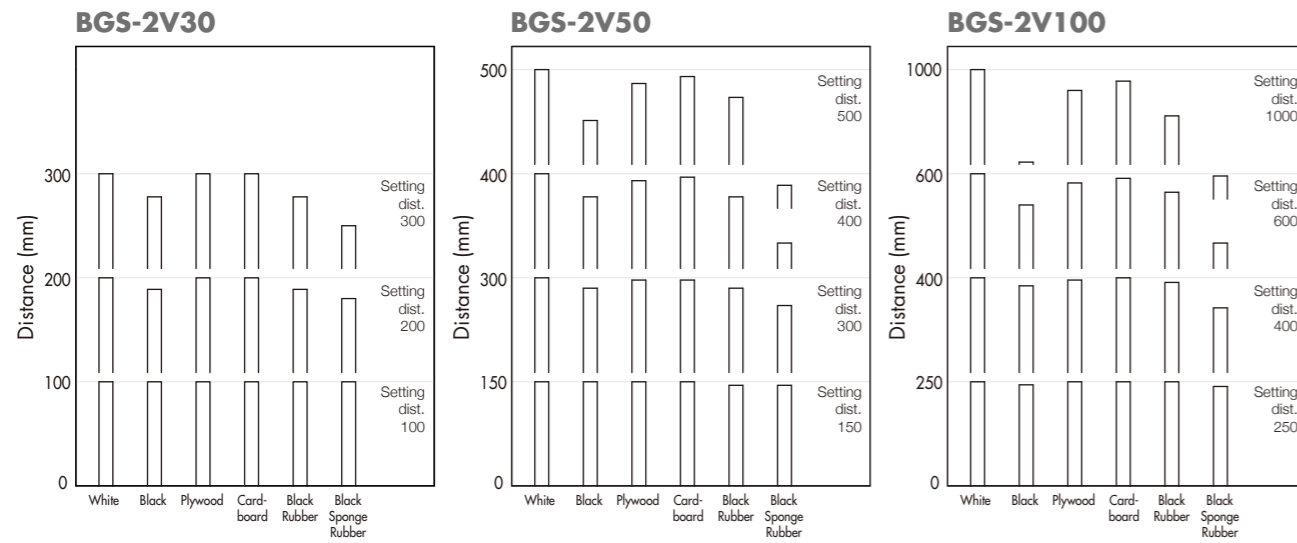

COLOR CHARACTERISTICS

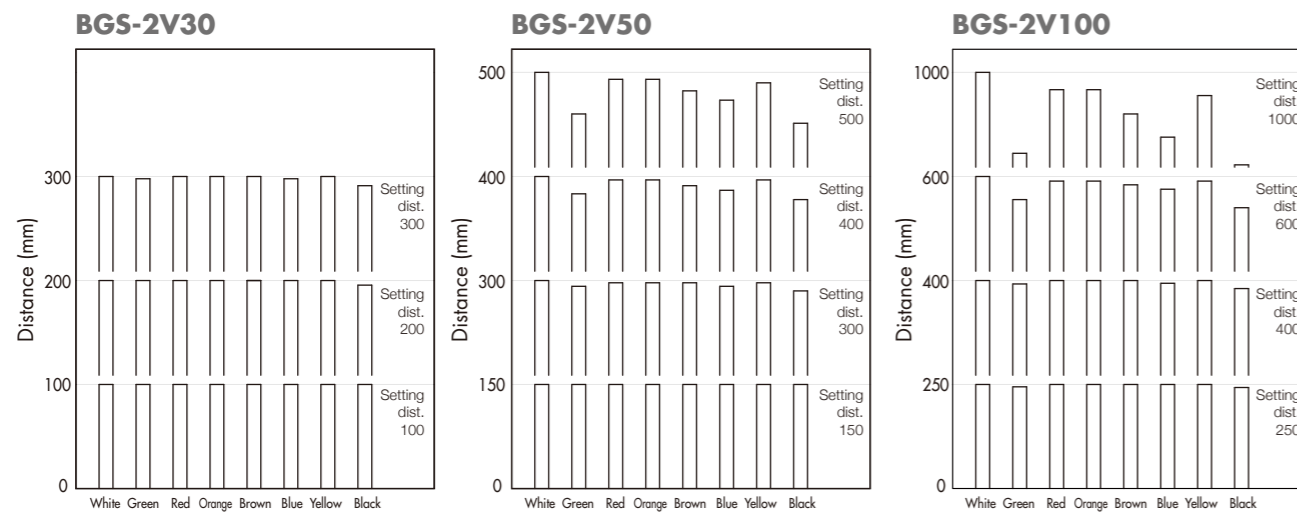

HYSTERESIS

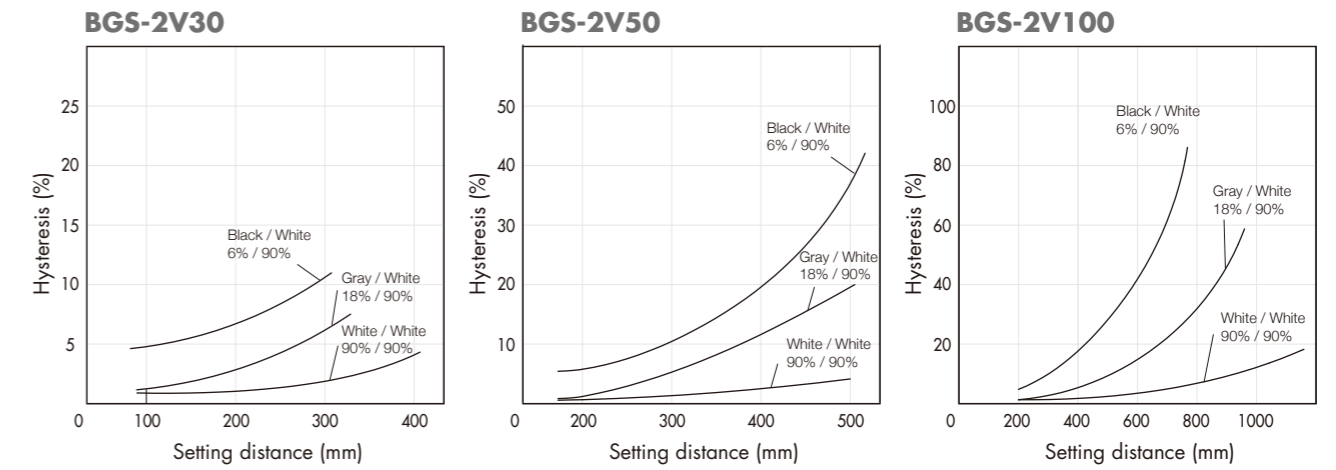

Options

Standard reflector V-61

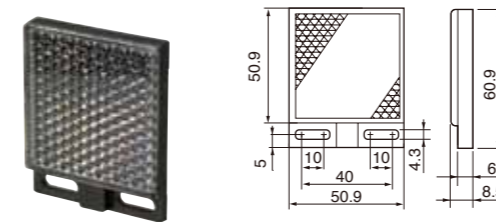

Small reflector V-42

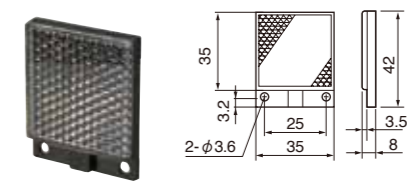

M12 connector cable
DOL-1204-G02M

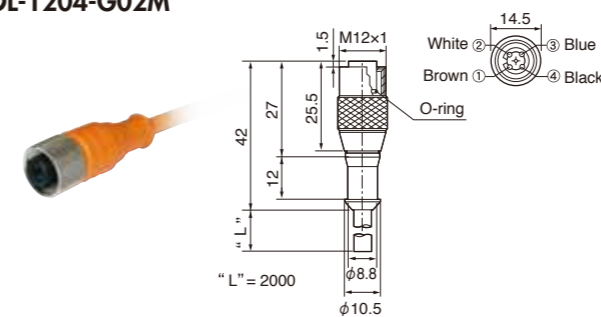

(Unit : mm)