

Selection diagram

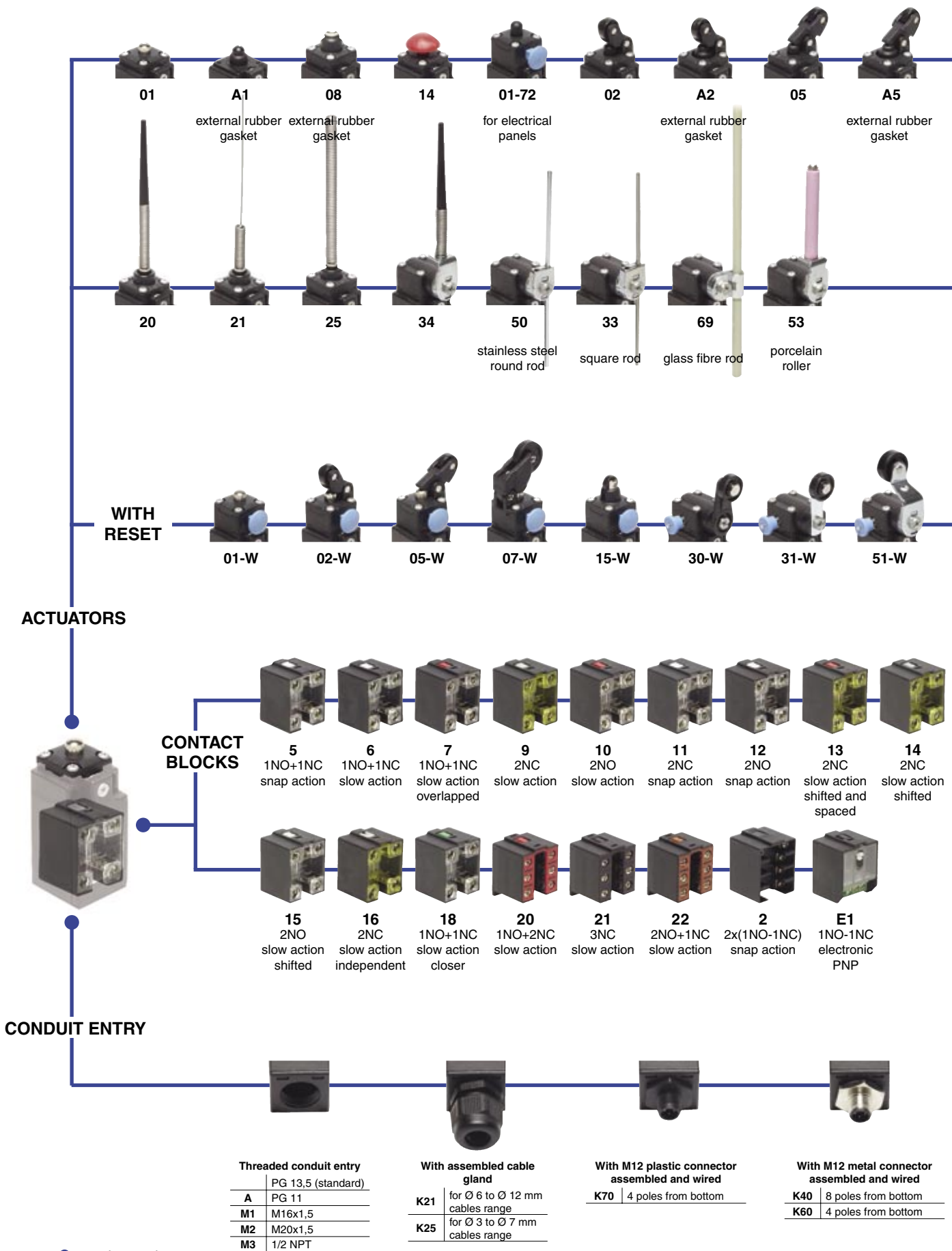

● product option
 → accessory sold separately

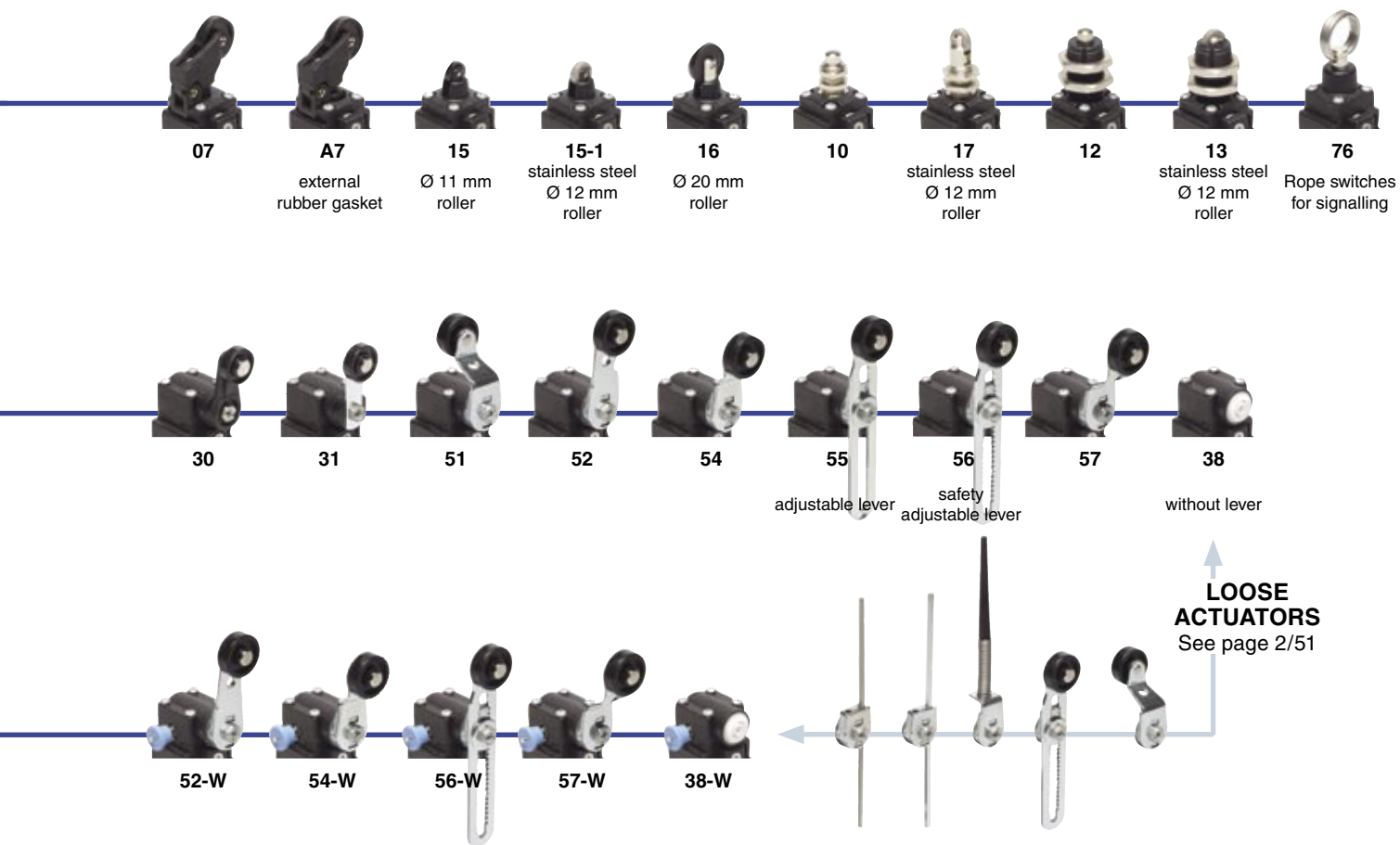

LOOSE ACTUATORS
See page 2/51

Code structure

Attention! The feasibility of a code number does not mean the effective availability of a product. Please contact our sales office.

FR 502-1WXGM2K70

Housing		Preinstalled cable gland or connectors	
FR	polymer housing, one conduit entry		no cable gland or connector (standard)
Contact blocks		K21	with assembled cable gland suitable for Ø 6 to Ø 12 mm cables range
5	1NO+1NC, snap action	K40	with M12 metal connector assembled and wired, 8 poles (only for contact blocks 2, 20, 21, 22)
6	1NO+1NC, slow action
7	1NO+1NC, slow action overlapped	For the complete list of all combinations, please contact our technical office.	
...	Threaded conduit entry	
Actuators			A PG 11
01	short plunger		M1 M16x1,5
02	roller lever		M2 M20x1,5
05	offset roller lever		M3 1/2 NPT
...	Contacts type	
Suffix		G	silver contacts (standard)
	no suffix (standard)		silver contacts gold plated 1 µm (contact block 2 excluded)
1	with stainless steel roller: - Ø 12 mm for actuator 15 - Ø 14 mm for actuators A2, 02, A5, 05 - Ø 20 mm for actuators 31, 51, 52, 54, 55, 56, 57	External metallic parts	
2	with Ø 35 mm polymer roller (see special loose actuators on page 2/52)	X	zinc plated steel (standard)
3	with Ø 50 mm rubber roller (see special loose actuators on page 2/52)		stainless steel
4	with Ø 50 mm overhanging rubber roller (see special loose actuators on page 2/52)	Reset hooking	
			without reset (standard)
		W	normal reset hooking
		W1	shorter reset hooking





© 2005 Copyright Pizzato Elettrica



Main data

- Polymer housing, one conduit entry
- Protection degree IP67
- 17 contact blocks available
- 43 actuators available
- External stainless steel parts versions
- M12 assembled connector versions
- Silver contacts gold plated versions



Markings and quality marks:

Approval IMQ: EG610
 Approval UL: E131787
 Approval CSA: LA 93682-1
 Approval EZU: 1010151

Technical data

Housing

Made of glass-reinforced polymer, self-extinguishing, shock-proof thermoplastic resin and with double insulation 
 One threaded conduit entry
 Protection degree: IP67 

General data

Ambient temperature: from -25°C to +80°C
 Version for operation in ambient temperature from -40°C to +80°C on request
 Max operating frequency: 3600 operations cycles¹/hour
 Mechanical endurance: 20 million operations cycles¹
 Assembling position: any
 (1) One operation cycle means two movements, one to close and one to open contacts, as foreseen by IEC 947-5-1 standard.

Cross section of the conductors (flexible copper wire)

Contact blocks 20, 21, 22, 33, 34:	min.	1 x 0,34 mm ²	(1 x AWG 22)
	max.	2 x 1,5 mm ²	(2 x AWG 16)
Contact blocks 5, 6, 7, 9, 10, 11, 12, 13, 14, 15, 16, 18:	min.	1 x 0,5 mm ²	(1 x AWG 20)
	max.	2 x 2,5 mm ²	(2 x AWG 14)
Contact block 2:	min.	1 x 0,5 mm ²	(1 x AWG 20)
	max.	2 x 1,5 mm ²	(2 x AWG 16)

In conformity with standards:

IEC 947-5-1, IEC 337-1, EN 60947-5-1, CEI EN 60947-5-1, CEI 17-45, EN 50047, CEI 17-33, IEC 204-1, EN 60204-1, CEI 44-5, EN 1088, EN ISO 12100-1, EN ISO 12100-2, IEC 529, EN 60529, CEI 70-1, NFC 63-140, VDE 0660-200, VDE 0113, CENELEC EN 50013.

Approvals:

IEC 947-5-1, UL 508, CSA C22-2 nr.14.

In conformity with requirements requested by:

Low Voltage Directive 73/23/EEC and subsequent modifications and completions.
 Machinery Directive 98/37/EEC.
 Electromagnetic Compatibility 89/336/EEC and subsequent modifications and completions.

Positive contact opening in conformity with standards:

IEC 947-5-1, EN 60947-5-1, CEI EN 60947-5-1, VDE 0660-206.

Installation for safety applications:

Use only switches marked with the symbol . The safety circuit must always be connected with the **NC contacts** (normally closed contacts: 11-12, 21-22 or 31-32) as stated in the **standard CEI EN 60947-5-1, encl. K, par. 2**. The switch must be actuated with **at least up to the positive opening travel** shown in the travels diagrams on page 6/15. The switch must be actuated **at least with the positive opening force**, shown in brackets, underneath each article, near the value of the min. force.

 **For the correct installation of all articles, please see “Utilization requirements” chapter, from page 6/1 to page 6/4.**

Electrical data		Utilization categories				
without connector	Thermal current (I _{th}):	10 A	Alternate current: AC15 (50...60 Hz)			
	Rated insulation voltage (U _i):	500 VAC 600 VDC 400 VAC for contact blocks 20, 21, 22, 33, 34	U _e (V)	250	400	500
	Protection against short circuits:	fuse 10 A 500 V type aM	I _e (A)	6	4	1
	Pollution degree:	3	Direct current: DC13			
			U _e (V)	24	125	250
			I _e (A)	6	1,1	0,4
with 4 or 5 poles M12 connector	Thermal current (I _{th}):	4 A	Alternate current: AC15 (50...60 Hz)			
	Rated insulation voltage (U _i):	250 VAC 300 VDC	U _e (V)	24	120	250
	Protection against short circuits:	fuse 4 A 500 V type gG	I _e (A)	4	4	4
	Pollution degree:	3	Direct current: DC13			
			U _e (V)	24	125	250
			I _e (A)	4	1,1	0,4
with 8 poles M12 connector	Thermal current (I _{th}):	2 A	Alternate current: AC15 (50...60 Hz)			
	Rated insulation voltage (U _i):	30 VAC 36 VDC	U _e (V)	24		
	Protection against short circuits:	fuse 2 A 500 V type gG	I _e (A)	2		
	Pollution degree:	3	Direct current: DC13			
			U _e (V)	24		
			I _e (A)	2		

Data type approved by IMQ and EZU

Rated insulation voltage (Ui): 500 VAC
 400 VAC for contact blocks 20, 21, 22, 33, 34

Thermal current (Ith): 10 A

Protection against short circuits: fuse 10 A 500 V type aM

Protection degree: IP67

MV terminals (screw clamps)

Pollution degree 3

Utilization category: AC15

Operation voltage (Ue): 400 VAC (50 Hz)

Operation current (Ie): 3 A

Forms of the contact element: Za, Zb, Za+Za, Y+Y, X+X, Y+Y+X, Y+Y+Y, Y+X+X

Positive opening of contacts on contact block 5, 6, 7, 9, 11, 12, 13, 14, 16, 18, 20, 21, 22, 33, 34

In conformity with standards: EN60947-1, EN 60947-5-1 and subsequent modifications and completions, fundamental requirements of the Low Voltage Directive 73/23 EEC and subsequent modifications and completions.

Please contact our technical service for the list of type approved products.

Data type approved by UL

Utilization categories Q300 (69 VA, 125-250 VDC)
 A600 (720 VA, 120-600 VAC)

Data of the housing type 1, 4X (indoor use only), 12, 13

In conformity with standard: UL 508

For all contact blocks except 2 and 3 use 60 or 75 °C copper (Cu) conductor and wire size No. 12-14 AWG. Terminal tightening torque of 7,1 Lb-In.

For contact blocks 2 and 3 use 60 or 75 °C copper (Cu) conductor and wire size No. 14 AWG. Terminal tightening torque of 12 Lb-In.

Please contact our technical service for the list of type approved products.

Data type approved by CSA

Utilization categories Q300 (69 VA, 125-250 VDC)
 A600 (720 VA, 120-600 VAC)

Data of the housing type 1, 4X (indoor use only), 12, 13

In conformity with standard: CSA C22-2 nr.14

Please contact our technical service for the list of type approved products.

Adjustable levers

In switches with revolving lever it is possible to adjust the lever with 10° steps for the whole 360° range. The positive movement transmission is always guaranteed thanks to the particular geometrical coupling between the lever and the revolving shaft as prescribed for safety applications by the German standard BG-GS-ET-15.

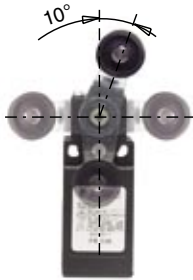

Overturning levers

It's possible to fasten the lever on switches on straight or reverse side, maintaining the positive coupling. In this way it is possible to obtain two different work plans of the lever.





Rotating heads

In all switches, it is possible to rotate the head in 90° steps.



Working operation of contact block 16 with independent contacts

The contact block 16 has two NC contacts, both with positive opening activated independently according to the lever turning direction.

<p>Lever turned to left</p>  <p>Contacts diagram</p> <pre> 11 / 12 21 \ 22 </pre>	<p>Lever not turned</p>  <p>Contacts diagram</p> <pre> 11 / 12 21 / 22 </pre>	<p>Lever turned to right</p>  <p>Contacts diagram</p> <pre> 11 \ 12 21 / 22 </pre>
--	--	---

2 Position switches FR series

Contacts type:

- R** = snap action
- L** = slow action
- LO** = slow action overlapped
- LS** = slow action shifted
- LV** = slow action shifted and spaced
- LI** = slow action independent
- LA** = slow action closer
- E** = electronic PNP

Contact blocks

		With external rubber gasket	With stainless steel roller on request	With external rubber gasket With stainless steel roller on request	
5	R	FR 501 \rightarrow 1NO+1NC	FR 5A1 \rightarrow 1NO+1NC	FR 502 \rightarrow 1NO+1NC	FR 5A2 \rightarrow 1NO+1NC
6	L	FR 601 \rightarrow 1NO+1NC	FR 6A1 \rightarrow 1NO+1NC	FR 602 \rightarrow 1NO+1NC	FR 6A2 \rightarrow 1NO+1NC
7	LO	FR 701 \rightarrow 1NO+1NC	FR 7A1 \rightarrow 1NO+1NC	FR 702 \rightarrow 1NO+1NC	FR 7A2 \rightarrow 1NO+1NC
9	L	FR 901 \rightarrow 2NC	FR 9A1 \rightarrow 2NC	FR 902 \rightarrow 2NC	FR 9A2 \rightarrow 2NC
10	L	FR 1001 2NO	FR 10A1 2NO	FR 1002 2NO	FR 10A2 2NO
11	R	FR 1101 \rightarrow 2NC	FR 11A1 \rightarrow 2NC	FR 1102 \rightarrow 2NC	FR 11A2 \rightarrow 2NC
12	R	FR 1201 2NO	FR 12A1 2NO	FR 1202 2NO	FR 12A2 2NO
13	LV	FR 1301 \rightarrow 2NC	FR 13A1 \rightarrow 2NC	FR 1302 \rightarrow 2NC	FR 13A2 \rightarrow 2NC
14	LS	FR 1401 \rightarrow 2NC	FR 14A1 \rightarrow 2NC	FR 1402 \rightarrow 2NC	FR 14A2 \rightarrow 2NC
15	LS	FR 1501 2NO	FR 15A1 2NO	FR 1502 2NO	FR 15A2 2NO
18	LA	FR 1801 \rightarrow 1NO+1NC	FR 18A1 \rightarrow 1NO+1NC	FR 1802 \rightarrow 1NO+1NC	FR 18A2 \rightarrow 1NO+1NC
20	L	FR 2001 \rightarrow 1NO+2NC	FR 20A1 \rightarrow 1NO+2NC	FR 2002 \rightarrow 1NO+2NC	FR 20A2 \rightarrow 1NO+2NC
21	L	FR 2101 \rightarrow 3NC	FR 21A1 \rightarrow 3NC	FR 2102 \rightarrow 3NC	FR 21A2 \rightarrow 3NC
22	L	FR 2201 \rightarrow 2NO+1NC	FR 22A1 \rightarrow 2NO+1NC	FR 2202 \rightarrow 2NO+1NC	FR 22A2 \rightarrow 2NO+1NC
2	R	FR 201 2x(1NO-1NC)		FR 202 2x(1NO-1NC)	FR 2A2 2x(1NO-1NC)
E1	E	FR E101 1NO-1NC	FR E1A1 1NO-1NC	FR E102 1NO-1NC	FR E1A2 1NO-1NC
Max speed		page 6/3 - type 4	page 6/3 - type 4	page 6/3 - type 3	page 6/3 - type 3
Min. force		8 N (25 N \rightarrow)	6 N (25 N \rightarrow)	6 N (25 N \rightarrow)	4,3 N (25 N \rightarrow)
Travel diagrams		page 6/15 - group 1	page 6/15 - group 1	page 6/15 - group 2	page 6/15 - group 2

		With stainless steel roller on request	With external rubber gasket With stainless steel roller on request	With external rubber gasket	
5	R	FR 505 \rightarrow 1NO+1NC	FR 5A5 \rightarrow 1NO+1NC	FR 507 \rightarrow 1NO+1NC	FR 5A7 \rightarrow 1NO+1NC
6	L	FR 605 \rightarrow 1NO+1NC	FR 6A5 \rightarrow 1NO+1NC	FR 607 \rightarrow 1NO+1NC	FR 6A7 \rightarrow 1NO+1NC
7	LO	FR 705 \rightarrow 1NO+1NC	FR 7A5 \rightarrow 1NO+1NC	FR 707 \rightarrow 1NO+1NC	FR 7A7 \rightarrow 1NO+1NC
9	L	FR 905 \rightarrow 2NC	FR 9A5 \rightarrow 2NC	FR 907 \rightarrow 2NC	FR 9A7 \rightarrow 2NC
10	L	FR 1005 2NO	FR 10A5 2NO	FR 1007 2NO	FR 10A7 2NO
11	R	FR 1105 \rightarrow 2NC	FR 11A5 \rightarrow 2NC	FR 1107 \rightarrow 2NC	FR 11A7 \rightarrow 2NC
12	R	FR 1205 2NO	FR 12A5 2NO	FR 1207 2NO	FR 12A7 2NO
13	LV	FR 1305 \rightarrow 2NC	FR 13A5 \rightarrow 2NC	FR 1307 \rightarrow 2NC	FR 13A7 \rightarrow 2NC
14	LS	FR 1405 \rightarrow 2NC	FR 14A5 \rightarrow 2NC	FR 1407 \rightarrow 2NC	FR 14A7 \rightarrow 2NC
15	LS	FR 1505 2NO	FR 15A5 2NO	FR 1507 2NO	FR 15A7 2NO
18	LA	FR 1805 \rightarrow 1NO+1NC	FR 18A5 \rightarrow 1NO+1NC	FR 1807 \rightarrow 1NO+1NC	FR 18A7 \rightarrow 1NO+1NC
20	L	FR 2005 \rightarrow 1NO+2NC	FR 20A5 \rightarrow 1NO+2NC	FR 2007 \rightarrow 1NO+2NC	FR 20A7 \rightarrow 1NO+2NC
21	L	FR 2105 \rightarrow 3NC	FR 21A5 \rightarrow 3NC	FR 2107 \rightarrow 3NC	FR 21A7 \rightarrow 3NC
22	L	FR 2205 \rightarrow 2NO+1NC	FR 22A5 \rightarrow 2NO+1NC	FR 2207 \rightarrow 2NO+1NC	FR 22A7 \rightarrow 2NO+1NC
2	R	FR 205 2x(1NO-1NC)	FR 2A5 2x(1NO-1NC)	FR 207 2x(1NO-1NC)	FR 2A7 2x(1NO-1NC)
E1	E	FR E105 1NO-1NC	FR E1A5 1NO-1NC	FR E107 1NO-1NC	FR E1A7 1NO-1NC
Max speed		page 6/3 - type 3	page 6/3 - type 3	page 6/3 - type 3	page 6/3 - type 3
Min. force		6 N (25 N \rightarrow)	4,3 N (25 N \rightarrow)	4 N (25 N \rightarrow)	3 N (25 N \rightarrow)
Travel diagrams		page 6/15 - group 2	page 6/15 - group 2	page 6/15 - group 3	page 6/15 - group 3

Accessories
See page 5/1

Items with code on the green background are available in stock

All measures in the drawings are in mm

- Contacts type:
- R** = snap action
 - L** = slow action
 - LO** = slow action overlapped
 - LS** = slow action shifted
 - LV** = slow action shifted and spaced
 - LI** = slow action independent
 - LA** = slow action closer
 - E** = electronic PNP

With external rubber gasket

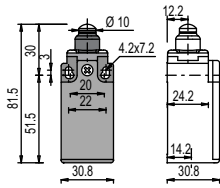

Fixed only by threaded head in vertical position

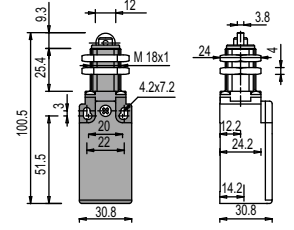
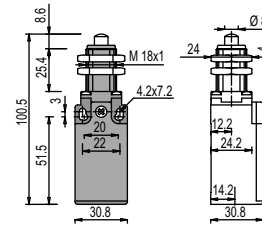
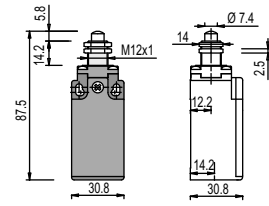

Contact blocks

5	R	FR 508	1NO+1NC	FR 510	1NO+1NC	FR 512	1NO+1NC	FR 513	1NO+1NC
6	L	FR 608	1NO+1NC	FR 610	1NO+1NC	FR 612	1NO+1NC	FR 613	1NO+1NC
7	LO	FR 708	1NO+1NC	FR 710	1NO+1NC	FR 712	1NO+1NC	FR 713	1NO+1NC
9	L	FR 908	2NC	FR 910	2NC	FR 912	2NC	FR 913	2NC
10	L	FR 1008	2NO	FR 1010	2NO	FR 1012	2NO	FR 1013	2NO
11	R	FR 1108	2NC	FR 1110	2NC	FR 1112	2NC	FR 1113	2NC
12	R	FR 1208	2NO	FR 1210	2NO	FR 1212	2NO	FR 1213	2NO
13	LV	FR 1308	2NC	FR 1310	2NC	FR 1312	2NC	FR 1313	2NC
14	LS	FR 1408	2NC	FR 1410	2NC	FR 1412	2NC	FR 1413	2NC
15	LS	FR 1508	2NO	FR 1510	2NO	FR 1512	2NO	FR 1513	2NO
18	LA	FR 1808	1NO+1NC	FR 1810	1NO+1NC	FR 1812	1NO+1NC	FR 1813	1NO+1NC
20	L	FR 2008	1NO+2NC	FR 2010	1NO+2NC	FR 2012	1NO+2NC	FR 2013	1NO+2NC
21	L	FR 2108	3NC	FR 2110	3NC	FR 2112	3NC	FR 2113	3NC
22	L	FR 2208	2NO+1NC	FR 2210	2NO+1NC	FR 2212	2NO+1NC	FR 2213	2NO+1NC
2	R	FR 208	2x(1NO-1NC)	FR 210	2x(1NO-1NC)	FR 212	2x(1NO-1NC)	FR 213	2x(1NO-1NC)
E1	E	FR E108	1NO-1NC	FR E110	1NO-1NC	FR E112	1NO-1NC	FR E113	1NO-1NC
Max speed		page 6/3 - type 4		page 6/3 - type 4		page 6/3 - type 4		page 6/3 - type 2	
Min. force		8 N (25 N \rightarrow)		8 N (25 N \rightarrow)		8 N (25 N \rightarrow)		8 N (25 N \rightarrow)	
Travel diagrams		page 6/15 - group 1		page 6/15 - group 1		page 6/15 - group 1		page 6/15 - group 1	

Ø 11 mm polymer roller

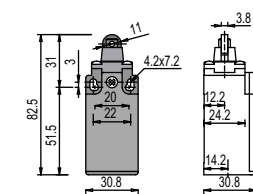

Ø 12 mm stainless steel roller

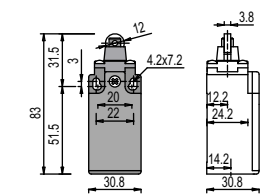

Contact blocks

5	R	FR 514	1NO+1NC	FR 515	1NO+1NC	FR 515-1	1NO+1NC	FR 516	1NO+1NC
6	L	FR 614	1NO+1NC	FR 615	1NO+1NC	FR 615-1	1NO+1NC	FR 616	1NO+1NC
7	LO	FR 714	1NO+1NC	FR 715	1NO+1NC	FR 715-1	1NO+1NC	FR 716	1NO+1NC
9	L	FR 914	2NC	FR 915	2NC	FR 915-1	2NC	FR 916	2NC
10	L	FR 1014	2NO	FR 1015	2NO	FR 1015-1	2NO	FR 1016	2NO
11	R	FR 1114	2NC	FR 1115	2NC	FR 1115-1	2NC	FR 1116	2NC
12	R	FR 1214	2NO	FR 1215	2NO	FR 1215-1	2NO	FR 1216	2NO
13	LV	FR 1314	2NC	FR 1315	2NC	FR 1315-1	2NC	FR 1316	2NC
14	LS	FR 1414	2NC	FR 1415	2NC	FR 1415-1	2NC	FR 1416	2NC
15	LS	FR 1514	2NO	FR 1515	2NO	FR 1515-1	2NO	FR 1516	2NO
18	LA	FR 1814	1NO+1NC	FR 1815	1NO+1NC	FR 1815-1	1NO+1NC	FR 1816	1NO+1NC
20	L	FR 2014	1NO+2NC	FR 2015	1NO+2NC	FR 2015-1	1NO+2NC	FR 2016	1NO+2NC
21	L	FR 2114	3NC	FR 2115	3NC	FR 2115-1	3NC	FR 2116	3NC
22	L	FR 2214	2NO+1NC	FR 2215	2NO+1NC	FR 2215-1	2NO+1NC	FR 2216	2NO+1NC
2	R	FR 214	2x(1NO-1NC)	FR 215	2x(1NO-1NC)	FR 215-1	2x(1NO-1NC)	FR 216	2x(1NO-1NC)
E1	E	FR E114	1NO-1NC	FR E115	1NO-1NC	FR E115-1	1NO-1NC	FR E116	1NO-1NC
Max speed		page 6/3 - type 4		page 6/3 - type 2		page 6/3 - type 2		page 6/3 - type 2	
Min. force		8 N (25 N \rightarrow)		8 N (25 N \rightarrow)		8 N (25 N \rightarrow)		8 N (25 N \rightarrow)	
Travel diagrams		page 6/15 - group 1		page 6/15 - group 1		page 6/15 - group 1		page 6/15 - group 1	

Accessories
See page 5/1

Items with code on the green background are available in stock

2 Position switches FR series

Contacts type:

- R** = snap action
- L** = slow action
- LO** = slow action overlapped
- LS** = slow action shifted
- LV** = slow action shifted and spaced
- LI** = slow action independent
- LA** = slow action closer
- E** = electronic PNP

Contact blocks

Fixed only by threaded head in vertical position

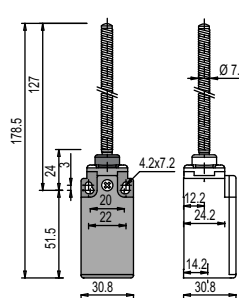
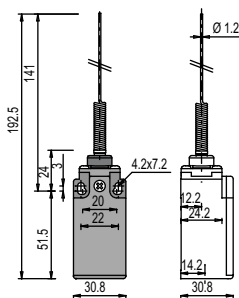
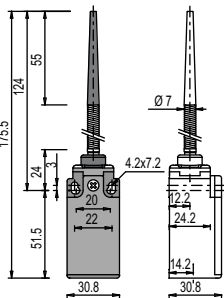
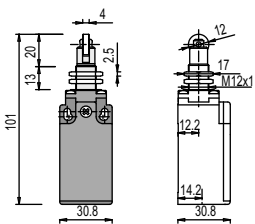

5	R	FR 517	1NO+1NC	FR 520	1NO+1NC	FR 521	1NO+1NC	FR 525	1NO+1NC
6	L	FR 617	1NO+1NC						
7	LO	FR 717	1NO+1NC						
9	L	FR 917	2NC						
10	L	FR 1017	2NO	FR 1020	2NO	FR 1021	2NO	FR 1025	2NO
11	R	FR 1117	2NC						
12	R	FR 1217	2NO	FR 1220	2NO	FR 1221	2NO	FR 1225	2NO
13	LV	FR 1317	2NC						
14	LS	FR 1417	2NC						
15	LS	FR 1517	2NO						
18	LA	FR 1817	1NO+1NC	FR 1820	1NO+1NC	FR 1821	1NO+1NC	FR 1825	1NO+1NC
20	L	FR 2017	1NO+2NC	FR 2020	1NO+2NC	FR 2021	1NO+2NC	FR 2025	1NO+2NC
21	L	FR 2117	3NC	FR 2120	3NC	FR 2121	3NC	FR 2125	3NC
22	L	FR 2217	2NO+1NC	FR 2220	2NO+1NC	FR 2221	2NO+1NC	FR 2225	2NO+1NC
2	R	FR 217	2x(1NO-1NC)	FR 220	2x(1NO-1NC)	FR 221	2x(1NO-1NC)	FR 225	2x(1NO-1NC)
E1	E	FR E117	1NO-1NC	FR E120	1NO-1NC	FR E121	1NO-1NC	FR E125	1NO-1NC
Max speed		page 6/3 - type 2		1 m/s		1 m/s		1 m/s	
Min. force		8 N (25 N ⊕)		0,06 Nm		0,04 Nm		0,11 Nm	
Travel diagrams		page 6/15 - group 1		page 6/15 - group 4		page 6/15 - group 4		page 6/15 - group 4	

Other rollers available. See page 2/52

3x3 mm square rod

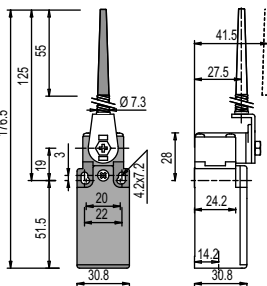
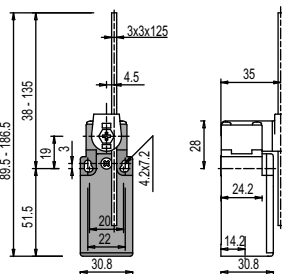
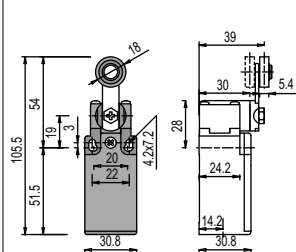
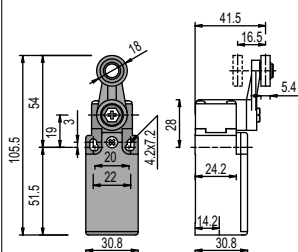

Contact blocks

5	R	FR 530	1NO+1NC	FR 531	1NO+1NC	FR 533	1NO+1NC	FR 534	1NO+1NC
6	L	FR 630	1NO+1NC	FR 631	1NO+1NC	FR 633	1NO+1NC	FR 634	1NO+1NC
7	LO	FR 730	1NO+1NC	FR 731	1NO+1NC	FR 733	1NO+1NC	FR 734	1NO+1NC
9	L	FR 930	2NC	FR 931	2NC	FR 933	2NC	FR 934	2NC
10	L	FR 1030	2NO	FR 1031	2NO	FR 1033	2NO	FR 1034	2NO
11	R	FR 1130	2NC	FR 1131	2NC	FR 1133	2NC	FR 1134	2NC
12	R	FR 1230	2NO	FR 1231	2NO	FR 1233	2NO	FR 1234	2NO
13	LV	FR 1330	2NC	FR 1331	2NC	FR 1333	2NC	FR 1334	2NC
14	LS	FR 1430	2NC	FR 1431	2NC	FR 1433	2NC	FR 1434	2NC
15	LS	FR 1530	2NO	FR 1531	2NO	FR 1533	2NO	FR 1534	2NO
16	LI	FR 1630	2NC	FR 1631	2NC	FR 1633	2NC	FR 1634	2NC
18	LA	FR 1830	1NO+1NC	FR 1831	1NO+1NC	FR 1833	1NO+1NC	FR 1834	1NO+1NC
20	L	FR 2030	1NO+2NC	FR 2031	1NO+2NC	FR 2033	1NO+2NC	FR 2034	1NO+2NC
21	L	FR 2130	3NC	FR 2131	3NC	FR 2133	3NC	FR 2134	3NC
22	L	FR 2230	2NO+1NC	FR 2231	2NO+1NC	FR 2233	2NO+1NC	FR 2234	2NO+1NC
2	R	FR 230	2x(1NO-1NC)	FR 231	2x(1NO-1NC)	FR 233	2x(1NO-1NC)	FR 234	2x(1NO-1NC)
E1	E	FR E130	1NO-1NC	FR E131	1NO-1NC	FR E133	1NO-1NC	FR E134	1NO-1NC
Max speed		page 6/3 - type 1		page 6/3 - type 1		1,5 m/s		1,5 m/s	
Min. force		0,1 Nm (0,25 Nm ⊕)		0,1 Nm (0,25 Nm ⊕)		0,1 Nm		0,1 Nm	
Travel diagrams		page 6/15 - group 5		page 6/15 - group 5		page 6/15 - group 5		page 6/15 - group 5	

Accessories
See page 5/1

Items with code on the green background are available in stock

- Contacts type:
- R** = snap action
 - L** = slow action
 - LO** = slow action overlapped
 - LS** = slow action shifted
 - LV** = slow action shifted and spaced
 - LI** = slow action independent
 - LA** = slow action closer
 -  = electronic PNP

Ø 3 mm stainless steel round rod

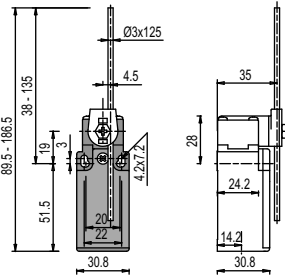

Other rollers available. See page 2/52

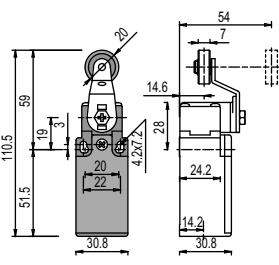

Other rollers available. See page 2/52

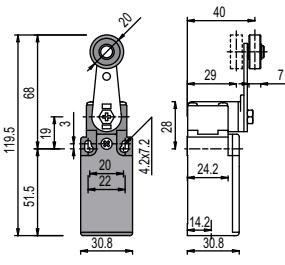

Porcelain roller

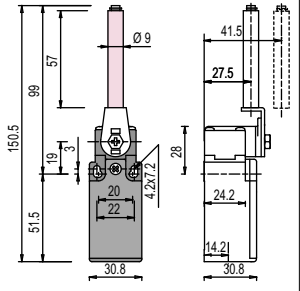

Contact blocks	FR 550	1NO+1NC	FR 551	1NO+1NC	FR 552	1NO+1NC	FR 553-E0V9	1NO+1NC
5 R	FR 550	1NO+1NC	FR 551	1NO+1NC	FR 552	1NO+1NC	FR 553-E0V9	1NO+1NC
6 L	FR 650	1NO+1NC	FR 651	1NO+1NC	FR 652	1NO+1NC	FR 653-E0V9	1NO+1NC
7 LO	FR 750	1NO+1NC	FR 751	1NO+1NC	FR 752	1NO+1NC	FR 753-E0V9	1NO+1NC
9 L	FR 950	2NC	FR 951	2NC	FR 952	2NC	FR 953-E0V9	2NC
10 L	FR 1050	2NO	FR 1051	2NO	FR 1052	2NO	FR 1053-E0V9	2NO
11 R	FR 1150	2NC	FR 1151	2NC	FR 1152	2NC		
12 R	FR 1250	2NO	FR 1251	2NO	FR 1252	2NO	FR 1253-E0V9	2NO
13 LV	FR 1350	2NC	FR 1351	2NC	FR 1352	2NC	FR 1353-E0V9	2NC
14 LS	FR 1450	2NC	FR 1451	2NC	FR 1452	2NC	FR 1453-E0V9	2NC
15 LS	FR 1550	2NO	FR 1551	2NO	FR 1552	2NO	FR 1553-E0V9	2NO
16 LI	FR 1650	2NC	FR 1651	2NC	FR 1652	2NC		
18 LA	FR 1850	1NO+1NC	FR 1851	1NO+1NC	FR 1852	1NO+1NC	FR 1853-E0V9	1NO+1NC
20 L	FR 2050	1NO+2NC	FR 2051	1NO+2NC	FR 2052	1NO+2NC	FR 2053-E0V9	1NO+2NC
21 L	FR 2150	3NC	FR 2151	3NC	FR 2152	3NC	FR 2153-E0V9	3NC
22 L	FR 2250	2NO+1NC	FR 2251	2NO+1NC	FR 2252	2NO+1NC	FR 2253-E0V9	2NO+1NC
2 R	FR 250	2x(1NO-1NC)	FR 251	2x(1NO-1NC)	FR 252	2x(1NO-1NC)	FR 253-E0	2x(1NO-1NC)
E1 	FR E150	1NO-1NC	FR E151	1NO-1NC	FR E152	1NO-1NC	FR E153-E0V9	1NO-1NC
Max speed	1,5 m/s		page 6/3 - type 1		page 6/3 - type 1		0,5 m/s	
Min. force	0,1 Nm		0,1 Nm (0,25 Nm ⊕)		0,1 Nm (0,25 Nm ⊕)		0,06 Nm (0,25 Nm ⊕)	
Travel diagrams	page 6/15 - group 5		page 6/15 - group 5		page 6/15 - group 5		page 6/15 - group 6	

Other rollers available. See page 2/52

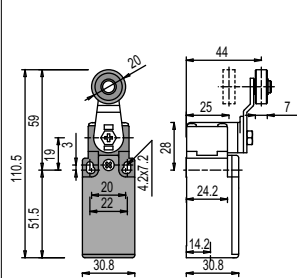

Other rollers available. See page 2/52

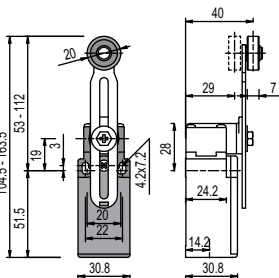

Other rollers available. See page 2/52

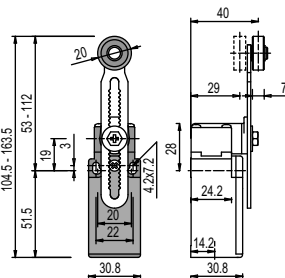

Other rollers available. See page 2/52

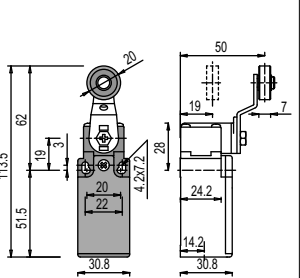

Contact blocks	FR 554	1NO+1NC	FR 555	1NO+1NC	FR 556	1NO+1NC	FR 557	1NO+1NC
5 R	FR 554	1NO+1NC	FR 555	1NO+1NC	FR 556	1NO+1NC	FR 557	1NO+1NC
6 L	FR 654	1NO+1NC	FR 655	1NO+1NC	FR 656	1NO+1NC	FR 657	1NO+1NC
7 LO	FR 754	1NO+1NC	FR 755	1NO+1NC	FR 756	1NO+1NC	FR 757	1NO+1NC
9 L	FR 954	2NC	FR 955	2NC	FR 956	2NC	FR 957	2NC
10 L	FR 1054	2NO	FR 1055	2NO	FR 1056	2NO	FR 1057	2NO
11 R	FR 1154	2NC	FR 1155	2NC	FR 1156	2NC	FR 1157	2NC
12 R	FR 1254	2NO	FR 1255	2NO	FR 1256	2NO	FR 1257	2NO
13 LV	FR 1354	2NC	FR 1355	2NC	FR 1356	2NC	FR 1357	2NC
14 LS	FR 1454	2NC	FR 1455	2NC	FR 1456	2NC	FR 1457	2NC
15 LS	FR 1554	2NO	FR 1555	2NO	FR 1556	2NO	FR 1557	2NO
16 LI	FR 1654	2NC	FR 1655	2NC	FR 1656	2NC	FR 1657	2NC
18 LA	FR 1854	1NO+1NC	FR 1855	1NO+1NC	FR 1856	1NO+1NC	FR 1857	1NO+1NC
20 L	FR 2054	1NO+2NC	FR 2055	1NO+2NC	FR 2056	1NO+2NC	FR 2057	1NO+2NC
21 L	FR 2154	3NC	FR 2155	3NC	FR 2156	3NC	FR 2157	3NC
22 L	FR 2254	2NO+1NC	FR 2255	2NO+1NC	FR 2256	2NO+1NC	FR 2257	2NO+1NC
2 R	FR 254	2x(1NO-1NC)	FR 255	2x(1NO-1NC)	FR 256	2x(1NO-1NC)	FR 257	2x(1NO-1NC)
E1 	FR E154	1NO-1NC	FR E155	1NO-1NC	FR E156	1NO-1NC	FR E157	1NO-1NC
Max speed	page 6/3 - type 1		page 6/3 - type 1		page 6/3 - type 1		page 6/3 - type 1	
Min. force	0,1 Nm (0,25 Nm ⊕)		0,1 Nm (0,25 Nm ⊕)		0,1 Nm (0,25 Nm ⊕)		0,1 Nm (0,25 Nm ⊕)	
Travel diagrams	page 6/15 - group 5		page 6/15 - group 5		page 6/15 - group 5		page 6/15 - group 5	

Accessories
See page 5/1

Items with code on the green background are available in stock

(1) Positive opening only with lever adjusted on the max. See page 2/51

2 Position switches FR series

Contacts type:

- R** = snap action
- L** = slow action
- LO** = slow action overlapped
- LS** = slow action shifted
- LV** = slow action shifted and spaced
- LI** = slow action independent
- LA** = slow action closer
- E** = electronic PNP

Glass fibre rod

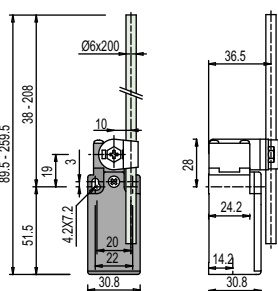

Rope switches for signalling

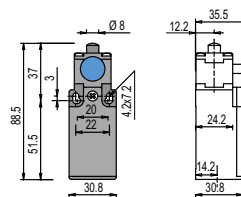
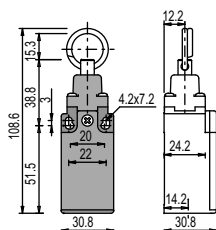

Contact blocks					
5	R	FR 569	1NO+1NC	FR 576	1NO+1NC
6	L	FR 669	1NO+1NC	FR 676	1NO+1NC
7	LO	FR 769	1NO+1NC	FR 776	1NO+1NC
9	L	FR 969	2NC	FR 976	2NO
10	L	FR 1069	2NO	FR 1076	2NC
11	R	FR 1169	2NC	FR 1176	2NO
12	R	FR 1269	2NO	FR 1276	2NC
13	LV	FR 1369	2NC	FR 1376	2NO
14	LS	FR 1469	2NC	FR 1476	2NO
15	LS	FR 1569	2NO	FR 1576	2NC
16	LI	FR 1669	2NC		
18	LA	FR 1869	1NO+1NC	FR 1876	1NO+1NC
20	L	FR 2069	1NO+2NC	FR 2076	2NO+1NC
21	L	FR 2169	3NC	FR 2176	3NO
22	L	FR 2269	2NO+1NC	FR 2276	1NO+2NC
2	R	FR 269	2x(1NO-1NC)	FR 276	2x(1NO-1NC)
E1	E	FR E169	1NO-1NC		
Max speed		1,5 m/s		0,5 m/s	
Min. force		0,1 Nm		initial 20 N - final 40 N	
Travel diagrams		page 6/15 - group 5		page 6/15 - group 7	
					FR 501-72 R 1NO+1NC
					FR 1001-72 2NO
					This switch can be installed on doors of electrical boards. It is used to switch on possible signal devices, once the door is open (e.g. three-phase flashing devices, etc.) The operator assigned to the board maintenance may simulate the closing of the door by pushing the blue push button. At the end of the maintenance the functionality of the switch will be automatically reestablished easily by closing the door of the board.
					page 6/3 - type 4
					8 N (25 N R)
					page 6/15 - group 1

Position switches FR series with reset

With stainless steel roller on request

With stainless steel roller on request

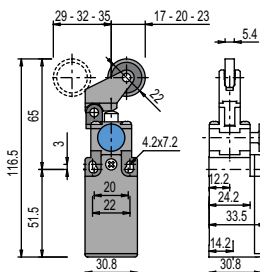
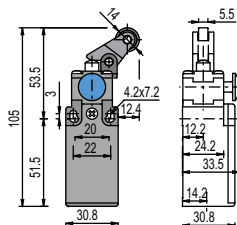
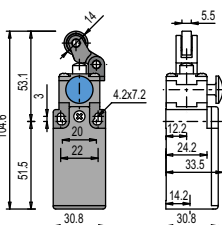
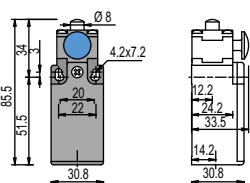

Contact blocks					
5	R	FR 501-W R	1NO+1NC	FR 502-W R	1NO+1NC
6	L	FR 601-W R	1NO+1NC	FR 602-W R	1NO+1NC
7	LO	FR 701-W R	1NO+1NC	FR 702-W R	1NO+1NC
9	L	FR 901-W R	2NC	FR 902-W R	2NC
10	L	FR 1001-W	2NO	FR 1002-W	2NO
11	R	FR 1101-W R	2NC	FR 1102-W R	2NC
12	R	FR 1201-W	2NO	FR 1202-W	2NO
13	LV	FR 1301-W R	2NC	FR 1302-W R	2NC
14	LS	FR 1401-W R	2NC	FR 1402-W R	2NC
15	LS	FR 1501-W	2NO	FR 1502-W	2NO
18	LA	FR 1801-W R	1NO+1NC	FR 1802-W R	1NO+1NC
20	L	FR 2001-W R	1NO+2NC	FR 2002-W R	1NO+2NC
21	L	FR 2101-W R	3NC	FR 2102-W R	3NC
22	L	FR 2201-W R	2NO+1NC	FR 2202-W R	2NO+1NC
2	R	FR 201-W	2x(1NO-1NC)	FR 202-W	2x(1NO-1NC)
Max speed		page 6/3 - type 4		page 6/3 - type 3	
Min. force		8 N (25 N R)		6 N (25 N R)	
Travel diagrams		page 6/16 - group 1		page 6/16 - group 2	
					FR 505-W R 1NO+1NC
					FR 507-W R 1NO+1NC
					FR 605-W R 1NO+1NC
					FR 607-W R 1NO+1NC
					FR 705-W R 1NO+1NC
					FR 707-W R 1NO+1NC
					FR 905-W R 2NC
					FR 907-W R 2NC
					FR 1005-W 2NO
					FR 1007-W 2NO
					FR 1105-W R 2NC
					FR 1107-W R 2NC
					FR 1205-W 2NO
					FR 1207-W 2NO
					FR 1305-W R 2NC
					FR 1307-W R 2NC
					FR 1405-W R 2NC
					FR 1407-W R 2NC
					FR 1505-W 2NO
					FR 1507-W 2NO
					FR 1805-W R 1NO+1NC
					FR 1807-W R 1NO+1NC
					FR 2005-W R 1NO+2NC
					FR 2007-W R 1NO+2NC
					FR 2105-W R 3NC
					FR 2107-W R 3NC
					FR 2205-W R 2NO+1NC
					FR 2207-W R 2NO+1NC
					FR 205-W 2x(1NO-1NC)
					FR 207-W 2x(1NO-1NC)
					page 6/3 - type 3
					4 N (25 N R)
					page 6/16 - group 3

Accessories
See page 5/1

Items with code on the green background are available in stock

- Contacts type:
- R** = snap action
 - L** = slow action
 - LO** = slow action overlapped
 - LS** = slow action shifted
 - LV** = slow action shifted and spaced
 - LI** = slow action independent
 - LA** = slow action closer
 - ⏏** = electronic PNP

With stainless steel roller on request

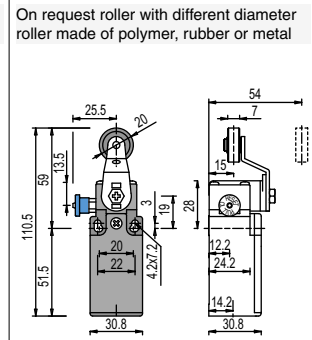
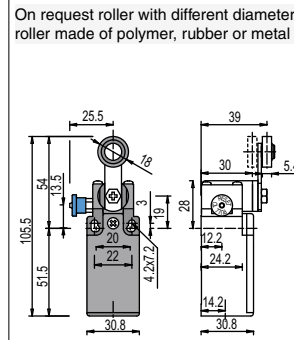
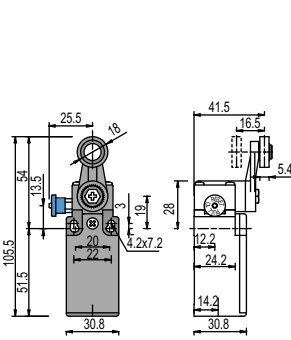
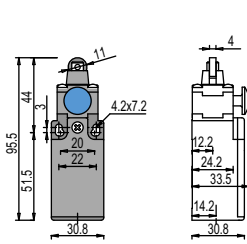

Contact blocks	FR 515-W	FR 530-W	FR 531-W	FR 551-W
5	R FR 515-W	⊖ FR 530-W	⊕ FR 531-W	⊕ FR 551-W
6	L FR 615-W	⊖ FR 630-W	⊕ FR 631-W	⊕ FR 651-W
7	LO FR 715-W	⊖ FR 730-W	⊕ FR 731-W	⊕ FR 751-W
9	L FR 915-W	⊖ FR 930-W	⊕ FR 931-W	⊕ FR 951-W
10	L FR 1015-W	⊖ FR 1030-W	⊖ FR 1031-W	⊖ FR 1051-W
11	R FR 1115-W	⊖ FR 1130-W	⊕ FR 1131-W	⊕ FR 1151-W
12	R FR 1215-W	⊖ FR 1230-W	⊖ FR 1231-W	⊖ FR 1251-W
13	LV FR 1315-W	⊖ FR 1330-W	⊖ FR 1331-W	⊖ FR 1351-W
14	LS FR 1415-W	⊖ FR 1430-W	⊖ FR 1431-W	⊖ FR 1451-W
15	LS FR 1515-W	⊖ FR 1530-W	⊖ FR 1531-W	⊖ FR 1551-W
18	LA FR 1815-W	⊕ FR 1830-W	⊕ FR 1831-W	⊕ FR 1851-W
20	L FR 2015-W	⊕ FR 2030-W	⊕ FR 2031-W	⊕ FR 2051-W
21	L FR 2115-W	⊕ FR 2130-W	⊕ FR 2131-W	⊕ FR 2151-W
22	L FR 2215-W	⊕ FR 2230-W	⊕ FR 2231-W	⊕ FR 2251-W
2	R FR 215-W	⊖ FR 230-W	⊖ FR 231-W	⊖ FR 251-W
Max speed	page 6/3 - type 2		page 6/3 - type 1	
Min. force	8 N (25 N ⊕)		0,1 Nm (0,25 Nm ⊕)	
Travel diagrams	page 6/16 - group 1		page 6/16 - group 4	

On request roller with different diameter roller made of polymer, rubber or metal

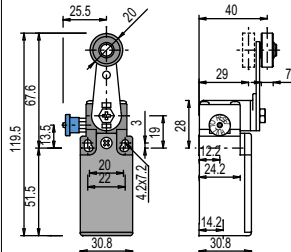

On request roller with different diameter roller made of polymer, rubber or metal

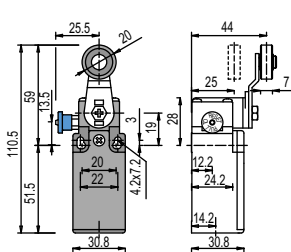

On request roller with different diameter roller made of polymer, rubber or metal

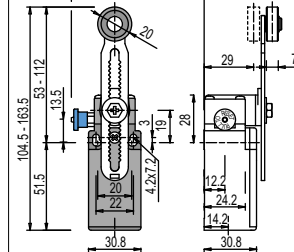

On request roller with different diameter roller made of polymer, rubber or metal

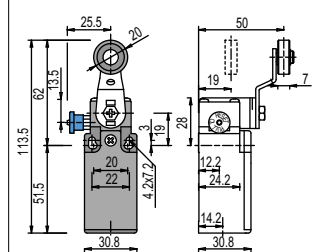

Contact blocks	FR 552-W	FR 554-W	FR 556-W	FR 557-W
5	R FR 552-W	⊖ FR 554-W	⊕ FR 556-W	⊕ FR 557-W
6	L FR 652-W	⊖ FR 654-W	⊕ FR 656-W	⊕ FR 657-W
7	LO FR 752-W	⊖ FR 754-W	⊕ FR 756-W	⊕ FR 757-W
9	L FR 952-W	⊖ FR 954-W	⊕ FR 956-W	⊕ FR 957-W
10	L FR 1052-W	⊖ FR 1054-W	⊖ FR 1056-W	⊖ FR 1057-W
11	R FR 1152-W	⊖ FR 1154-W	⊕ FR 1156-W	⊕ FR 1157-W
12	R FR 1252-W	⊖ FR 1254-W	⊖ FR 1256-W	⊖ FR 1257-W
13	LV FR 1352-W	⊖ FR 1354-W	⊖ FR 1356-W	⊖ FR 1357-W
14	LS FR 1452-W	⊖ FR 1454-W	⊖ FR 1456-W	⊖ FR 1457-W
15	LS FR 1552-W	⊖ FR 1554-W	⊖ FR 1556-W	⊖ FR 1557-W
18	LA FR 1852-W	⊕ FR 1854-W	⊕ FR 1856-W	⊕ FR 1857-W
20	L FR 2052-W	⊕ FR 2054-W	⊕ FR 2056-W	⊕ FR 2057-W
21	L FR 2152-W	⊕ FR 2154-W	⊕ FR 2156-W	⊕ FR 2157-W
22	L FR 2252-W	⊕ FR 2254-W	⊕ FR 2256-W	⊕ FR 2257-W
2	R FR 252-W	⊖ FR 254-W	⊖ FR 256-W	⊖ FR 257-W
Max speed	page 6/3 - type 1		page 6/3 - type 1	
Min. force	0,1 Nm (0,25 Nm ⊕)		0,1 Nm (0,25 Nm ⊕)	
Travel diagrams	page 6/16 - group 4		page 6/16 - group 4	

Accessories
See page 5/1

Items with code on the green background are available in stock

2 Position switches FR series

Position switches with revolving lever without actuator

Contacts type:

- R** = snap action
- L** = slow action
- LO** = slow action overlapped
- LS** = slow action shifted
- LV** = slow action shifted and spaced
- LI** = slow action independent
- LA** = slow action closer
- △** = electronic PNP

Contact blocks

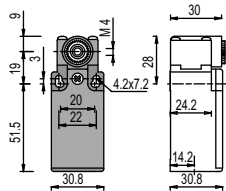

with manual reset knob

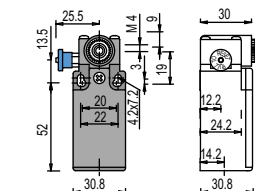

IMPORTANT

For safety applications: join only switches and actuators marked with symbol \ominus .
For more information about safety applications see page 6/1.

5	R	FR 538	\ominus 1NO+1NC	FR 538-W	\ominus 1NO+1NC
6	L	FR 638	\ominus 1NO+1NC	FR 638-W	\ominus 1NO+1NC
7	LO	FR 738	\ominus 1NO+1NC	FR 738-W	\ominus 1NO+1NC
9	L	FR 938	\ominus 2NC	FR 938-W	\ominus 2NC
10	L	FR 1038	2NO	FR 1038-W	2NO
11	R	FR 1138	\ominus 2NC	FR 1138-W	\ominus 2NC
12	R	FR 1238	2NO	FR 1238-W	2NO
13	LV	FR 1338	\ominus 2NC	FR 1338-W	\ominus 2NC
14	LS	FR 1438	\ominus 2NC	FR 1438-W	\ominus 2NC
15	LS	FR 1538	2NO	FR 1538-W	2NO
16	LI	FR 1638	\ominus 2NC		
18	LA	FR 1838	\ominus 1NO+1NC	FR 1838-W	\ominus 1NO+1NC
20	L	FR 2038	\ominus 1NO+2NC	FR 2038-W	\ominus 1NO+2NC
21	L	FR 2138	\ominus 3NC	FR 2138-W	\ominus 3NC
22	L	FR 2238	\ominus 2NO+1NC	FR 2238-W	\ominus 2NO+1NC
2	R	FR 238	2x(1NO-1NC)	FR 238-W	2x(1NO-1NC)
E1	△	FR E138	1NO-1NC		
Min. force		0,1 Nm (0,25 Nm \ominus)		0,1 Nm (0,25 Nm \ominus)	
Travel diagrams		page 6/15 - group 5		page 6/16 - group 4	

Items with code on the green background are available in stock

Accessories
See page 5/1

Loose actuators

IMPORTANT: These loose actuators can be used with items of series FR, FM, FX, FZ, FK only

10 pcs pack	Ø 18 mm roller	Ø 18 mm roller	Adjustable square rod 3x3x125 mm	Flexible rod actuator	Adjustable round rod Ø 3x125 mm	Polymer roller Ø 20 mm	
Article	VF LE30 \ominus	VF LE31 \ominus	VF LE33	VF LE34	VF LE50	VF LE51 \ominus	
10 pcs pack	Polymer roller Ø 20 mm	Porcelain roller	Polymer roller Ø 20 mm	Adjustable actuator with polymer roller	Adjustable safety actuator with polymer roller	Polymer roller Ø 20 mm	Adjustable glass fibre rod
Article	VF LE52 \ominus	VF LE53 \ominus (2)	VF LE54 \ominus	VF LE55 \ominus (1)	VF LE56 \ominus	VF LE57 \ominus	VF LE69

- Only orders for multiple quantities of the packs are accepted.

- (1) Actuator VF LE55 suits to safety applications only if adjusted to its max length, as you can see in figure beside. If you need an adjustable lever for safety applications, use the adjustable safety lever VF LE56.

- (2) The position switch obtained by assembling the switch FR •38 (e.g. FR 538, FR 638) with the actuator VF LE53 will not present the same travel diagrams and actuating forces as the position switch FR •53-E0V9 (e.g. FR 553-E0V9, FR 653-E0V9...).

- (4) The actuator cannot be oriented to inside direction because it will mechanically interfere with the switch head.

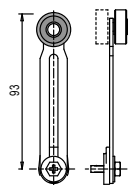

Special loose actuators

IMPORTANT: These loose actuators can be used with items of series FR, FM, FX, FZ, FK only

Ø 20 mm stainless steel rollers						10 pcs pack
VF LE31-1 (1)	VF LE51-1 (1)	VF LE52-1 (1)	VF LE54-1 (1)	VF LE55-1 (1) (1)	VF LE56-1 (1)	VF LE57-1 (1)
Ø 35 mm polymer rollers						10 pcs pack
VF LE31-2 (4)	VF LE51-2 (4)	VF LE52-2 (1)	VF LE54-2 (4)	VF LE55-2 (1) (1)	VF LE56-2 (1)	VF LE57-2 (1)
Ø 40 mm rubber rollers						10 pcs pack
VF LE31-R5 (4)	VF LE51-R5 (4)	VF LE52-R5 (1)	VF LE54-R5 (4)	VF LE55-R5 (1) (1)	VF LE56-R5 (1)	VF LE57-R5 (4)
Ø 50 mm rubber rollers						10 pcs pack
	VF LE51-3 (4)	VF LE52-3 (4)	VF LE54-3 (4)	VF LE55-3 (1) (1)	VF LE56-3 (1)	VF LE57-3 (4)
Ø 50 mm overhanging rubber rollers						10 pcs pack
	VF LE55-4 (1) (1)					VF LE56-4 (1)