

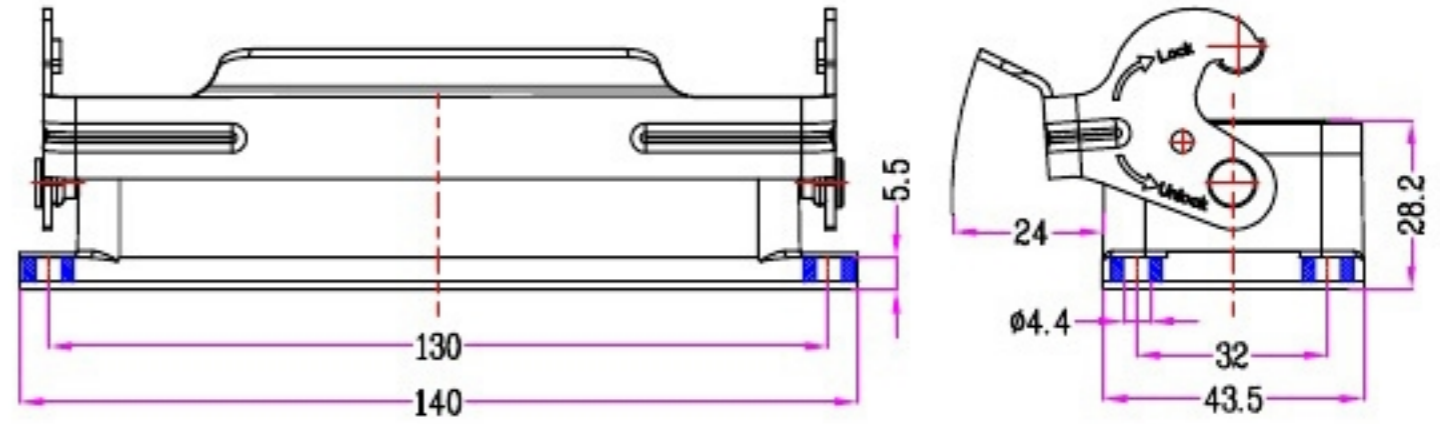

1	2	3	4	5
Identification	Type name	Part number	Thread(M/PG)	Lever type
Housings	HZW-H24B-ST-1PL	81 304 024 201		Metal
Bulkhead mounting				

REVISION DATA				
6	7	8		
SYM	ECN	DESCRIPTION	DATE	APPROVED

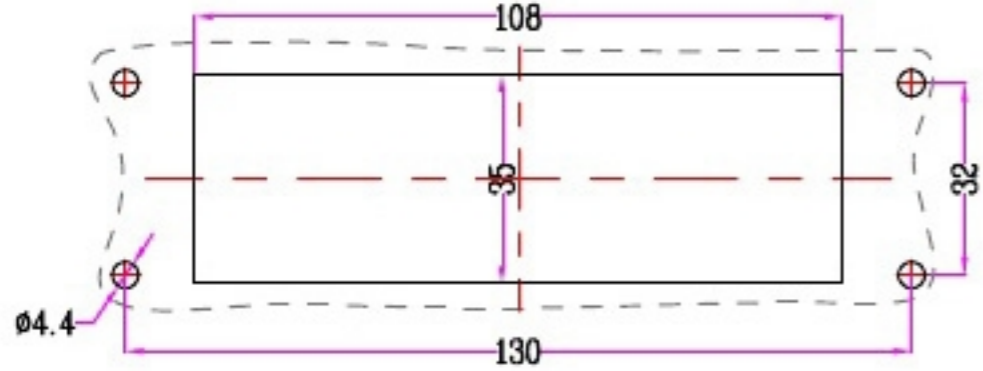

Bulkhead mounting  
Panel cut out

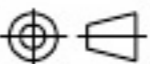

	SIGNATURE	DATE	Units	mm	 宁波欧科瑞连接器有限公司 NINGBO OKERUI CONNECTOR CO.,LTD.		
DRAW			Size	A4			
DESIGN			Scale		TYPE NAME	HZW-H24B-ST-1PL	
CHECK			Sheet	1/1	Part number	81 304 024 201	REV
APPROVE			Proj.		File path	OKR. 24B. H24BL	A0