

ASSEMBLY - VIEW FROM TOP

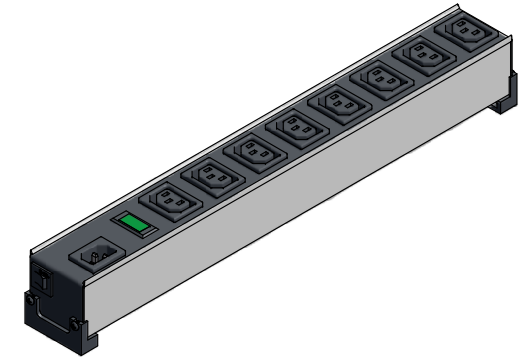

ISOMETRIC VIEW

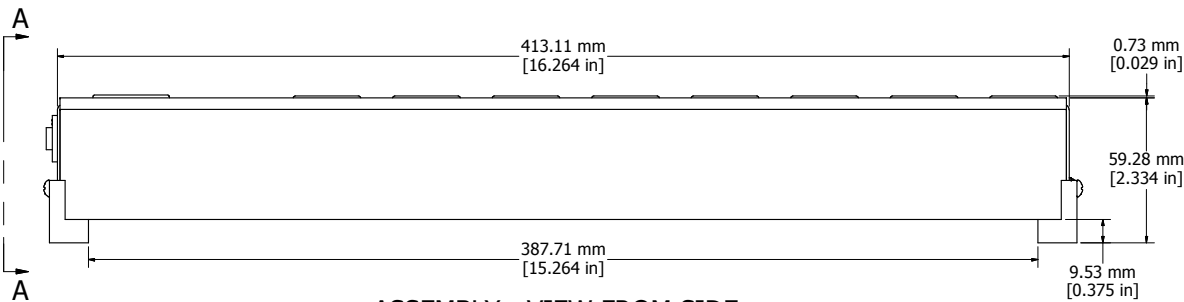

ASSEMBLY - VIEW FROM SIDE

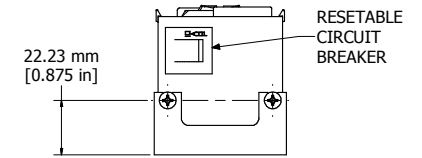

VIEW A-A

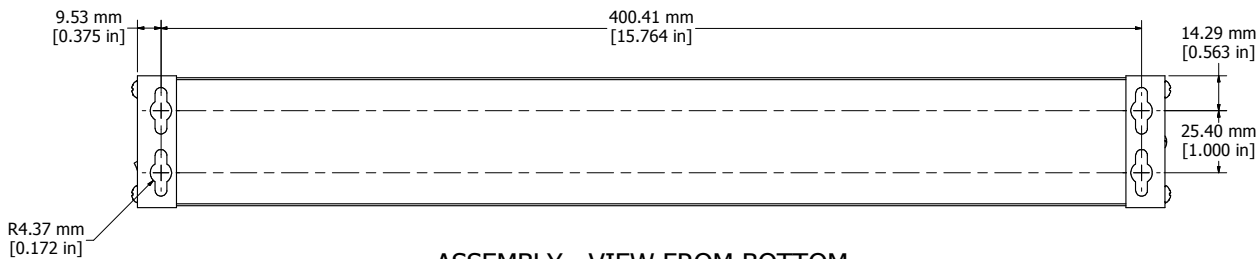

ASSEMBLY - VIEW FROM BOTTOM

1581T8
Finish - Top - Black Painted Steel
Bottom - Aluminum Extrusion
Rated - 100-240 VAC, 50/60 Hz, 10 Amps
Approvals - cULus Listed UL 60950-1 (2nd Edition); Amd1 + Amd2, and CAN/CSA C22.2 No. 60950-1-07 (2nd Edition); Amd1 + Amd2 - TÜV-SÜD Certified to EN 60950-1:2006/A2:2013-09, and IEC 60950-1 (ed.2); am1;am2 - CE compliant to European Low Voltage Directive 2014/35/EU

