



# ESSENTRA

COMPONENTS

## FOR EVERYTHING ENCLOSURE

### PVC EDGE PROTECTOR

- Provides excellent protection for steel edges
- 9 styles available
- Simple to install

SEE PAGES 498-499

### DRAWER SLIDES

- Available in light, medium and heavy duty
- Full or 3/4 extension

SEE PAGES 502-503

### GAS STRUTS AND FITTINGS

- Widely used in medical & laboratory, furniture, automotive and industrial equipment
- For opening, closing, tilting and damping
- Simple adjustment - can be done after installation

SEE PAGES 504-508

[www.essentracomponents.co.uk](http://www.essentracomponents.co.uk)



# GASKETING AND ENCLOSURE ACCESSORIES

---

GASKETING

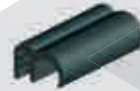

490

DRAWER SLIDES, GAS STRUTS  
AND LID STAYS



502

DRAWING POCKETS AND  
COUNTER SCREENS

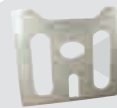

514

# GASKETING

## EPDM Sponge Adhesive Seal

SR5561

Black EPDM

- Supplied in rolls of 10m
- Easy to apply adhesive seal
- Ideal for metal enclosures

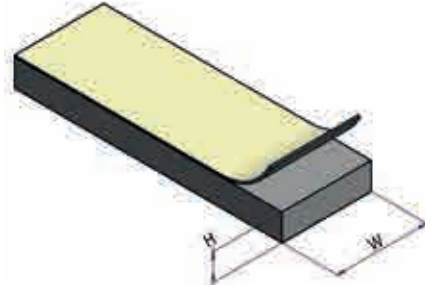

Part Number	Dimensions		Roll Length (m)
	W (mm)	H (mm)	
1200310001	10	3	10
1200510001	10	5	10
1200315001	15	3	10
1200515001	15	5	10
1200320001	20	3	10
1200520001	20	5	10
1200325001	25	3	10
1200530001	30	5	10

## Weather/Gasketing Strip

SR 1867

Black Neoprene, Nitrile, PVC blend

- Rubber-based permanent adhesive on one side (not recommended for direct UV exposure)
- Excellent resistance to acid, ozone and oxidation
- Service Temperature: -28°C to 101°C
- Density (kg/m<sup>3</sup>): 64 - 112
- Compression Deflection: 140 - 350 g/cm<sup>2</sup>
- For HVAC or electrical enclosures, lighting fixtures, vibration dampening and more



Part Number	Dimensions (mm)		Roll Length (m)	Rolls Per Carton
	Width	Thickness		
472061	12.7	3.2	15	20
472063	25.4	3.2	15	10
472067	12.7	6.4	15	20
472069	25.4	6.4	15	10

## Adhesive Bubble Gasket

SR5556

Black EPDM

- Supplied in rolls of 20m
- Easy to apply adhesive seal
- Type 6 splits down the centre to divide into 2x10m

### Type 1

Part Number	Type	Roll Length (m)
490765	1	20

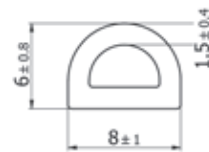

Type 1



### Type 2

Part Number	Type	Roll Length (m)
490766	2	20

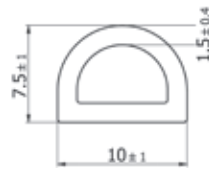

Type 2



### Type 3

Part Number	Type	Roll Length (m)
490767	3	20

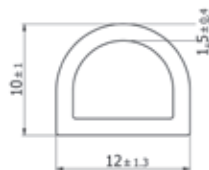

Type 3



### Type 4

Part Number	Type	Roll Length (m)
490768	4	20



Type 4



### Type 5

Part Number	Type	Roll Length (m)
490769	5	20

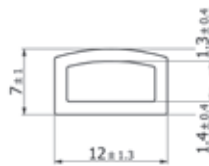

Type 5



### Type 6

Part Number	Type	Roll Length (m)
490770	6	2x10m

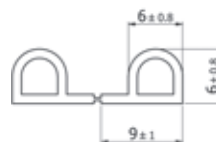

Type 6



## Top Bubble Gasket

SR5559

Black EPDM

- Supplied in rolls of 20m
- Clip on profile offering edge protection and sealing
- Profiles are flexible and are pressed on by hand
- With steel spring core



Type 1

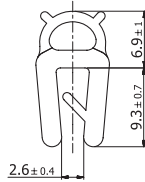

Type 2

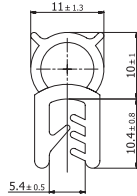

Type 3

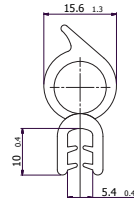

Type 4

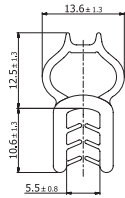

Type 5

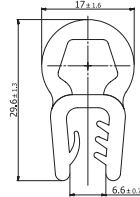

Type 6

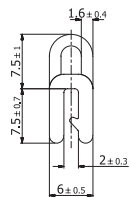

### Type 1

Part Number	Clamping Range (mm)	Type	Roll Length (m)
490743	0.5 - 2	1	20

### Type 2

Part Number	Clamping Range (mm)	Type	Roll Length (m)
34009104001	1 - 3	2	20

### Type 3

Part Number	Clamping Range (mm)	Type	Roll Length (m)
34009139001	2.5 - 3.5	3	20

### Type 4

Part Number	Clamping Range (mm)	Type	Roll Length (m)
490746	2.5 - 4	4	20

### Type 5

Part Number	Clamping Range (mm)	Type	Roll Length (m)
490747	4 - 5	5	20

### Type 6

Part Number	Clamping Range (mm)	Type	Roll Length (m)
34009100001	1 - 1.5	6	20

CONTINUED ON NEXT PAGE

**Top Bubble Gasket** *CONTINUED*

**SR5559**

**Black EPDM**

- Supplied in rolls of 20m
- Clip on profile offering edge protection and sealing
- Profiles are flexible and are pressed on by hand
- With steel spring core

**Type 7**

Part Number	Clamping Range (mm)	Type	Roll Length (m)
490749	0.5 - 1.5	7	20

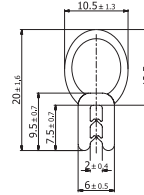

Type 7

**Type 8**

Part Number	Clamping Range (mm)	Type	Roll Length (m)
340091730018	1 - 3	8	20

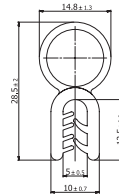

Type 8

**Type 9**

Part Number	Clamping Range (mm)	Type	Roll Length (m)
490751	3 - 5	9	20

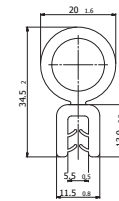

Type 9

**Type 10**

Part Number	Clamping Range (mm)	Type	Roll Length (m)
490752	2 - 3	10	20

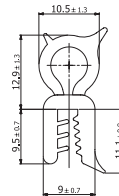

Type 10

**Type 11**

Part Number	Clamping Range (mm)	Type	Roll Length (m)
34009110001	2 - 3.5	11	20

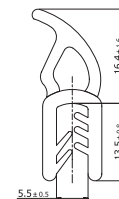

Type 11

## Side Bubble Gasket

SR5558

Black EPDM

- Supplied in rolls of 20m
- Clip on profile offering edge protection and sealing
- Profiles are flexible and pressed on by hand
- With steel spring core

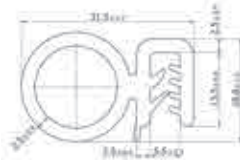

Type 1

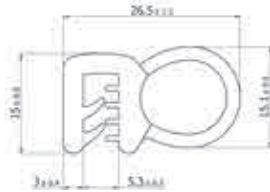

Type 2

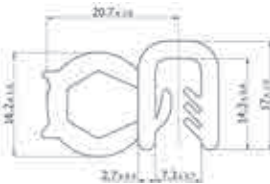

Type 3

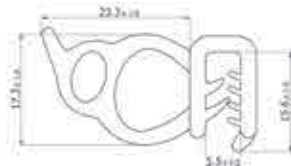

Type 4

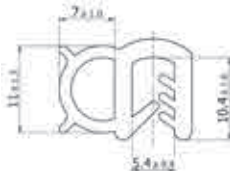

Type 5

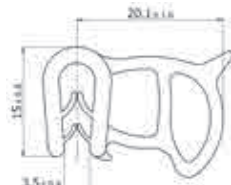

Type 6

### Type 1

Part Number	Clamping Range (mm)	Type	Roll Length (m)
34009083001	1.5 - 3	1	20

### Type 2

Part Number	Clamping Range (mm)	Type	Roll Length (m)
3400905001	2 - 3.5	2	20

### Type 3

Part Number	Clamping Range (mm)	Type	Roll Length (m)
34009041001	3 - 5	3	20

### Type 4

Part Number	Clamping Range (mm)	Type	Roll Length (m)
493007	2 - 5	4	20

### Type 5

Part Number	Clamping Range (mm)	Type	Roll Length (m)
34009002002	1 - 3	5	20

### Type 6

Part Number	Clamping Range (mm)	Type	Roll Length (m)
34009058001	1 - 2.5	6	20

CONTINUED ON NEXT PAGE

**Side Bubble Gasket** *CONTINUED*

SR5558

**Black EPDM**

- Supplied in rolls of 20m
- Clip on profile offering edge protection and sealing
- Profiles are flexible and pressed on by hand
- With steel spring core

**Type 7**

Part Number	Clamping Range (mm)	Type	Roll Length (m)
490737	2 - 3	7	20

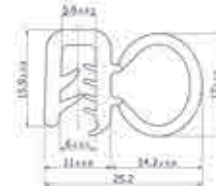

Type 7

**Type 8**

Part Number	Clamping Range (mm)	Type	Roll Length (m)
490738	1.5 - 3	8	20

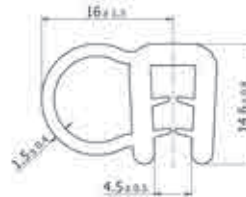

Type 8

**Type 9**

Part Number	Clamping Range (mm)	Type	Roll Length (m)
490739	2 - 3	9	20

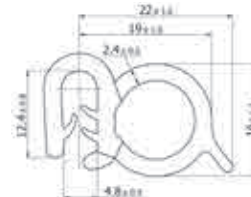

Type 9

**Type 10**

Part Number	Clamping Range (mm)	Type	Roll Length (m)
490740	2 - 3	10	20

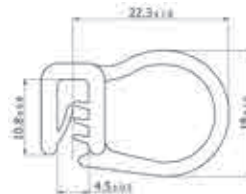

Type 10

**Type 11**

Part Number	Clamping Range (mm)	Type	Roll Length (m)
34009003002	1 - 2	11	20



Type 11

**Type 12**

Part Number	Clamping Range (mm)	Type	Roll Length (m)
490742	0.5 - 2	12	20

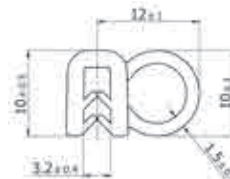

Type 12



## Single Flipper Gasket

SR5554

Black EPDM

- Single EPDM material flipper gasket
- Supplied in rolls of 20m
- Profiles are flexible and are pressed on by hand
- With steel spring core



Type 1



Type 2

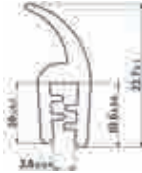

Type 3



Type 4



Type 5



Type 6



### Type 1

Part Number	Clamping Range (mm)	Type	Roll Length (m)
490754	1 - 3	1	20

### Type 2

Part Number	Clamping Range (mm)	Type	Roll Length (m)
490755	1 - 3	2	20

### Type 3

Part Number	Clamping Range (mm)	Type	Roll Length (m)
490756	1 - 3	3	20

### Type 4

Part Number	Clamping Range (mm)	Type	Roll Length (m)
490757	2 - 4	4	20

### Type 5

Part Number	Clamping Range (mm)	Type	Roll Length (m)
490758	2 - 4	5	20

### Type 6

Part Number	Clamping Range (mm)	Type	Roll Length (m)
490759	4 - 6	6	20

## Dual Flipper Gasket

SR5555

Black EPDM

- Dual material; hard rubber carrier to improve grip to panel and softer rubber to aid compression
- Supplied in rolls of 20m
- Profiles are flexible and are pressed on by hand
- With steel spring core

### Type 1

Part Number	Clamping Range (mm)	Type	Roll Length (m)
34009236001	1-3	1	20

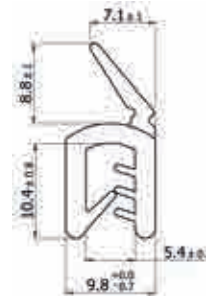

Type 1



### Type 2

Part Number	Clamping Range (mm)	Type	Roll Length (m)
490761	1-3	2	20

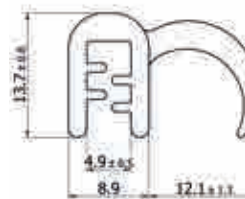

Type 2



### Type 3

Part Number	Clamping Range (mm)	Type	Roll Length (m)
490762	2-3	3	20

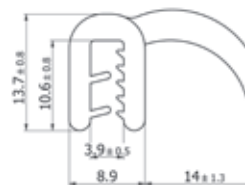

Type 3



### Type 4

Part Number	Clamping Range (mm)	Type	Roll Length (m)
34009205001	2-4	4	20

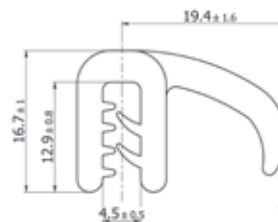

Type 4



### Type 5

Part Number	Clamping Range (mm)	Type	Roll Length (m)
490764	1-3	5	20

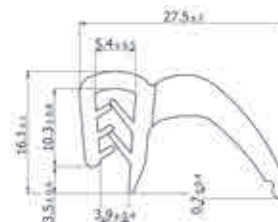

Type 5



## PVC Edge Protector

### Black PVC with steel spring core

- Supplied in rolls of 20m
- Provided protection to steel edges
- Profiles are flexible and pressed on by hand
- Suitable for -25°C to 90°C



Type 1

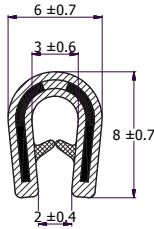

Type 1



Type 2

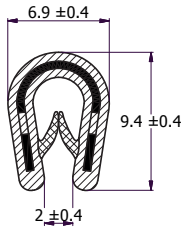

Type 2



Type 3

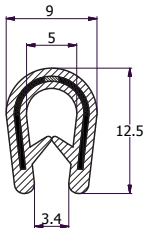

Type 3



Type 4

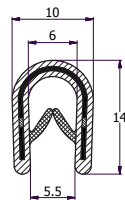

Type 4



Type 5

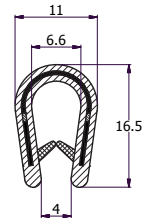

Type 5



Type 6

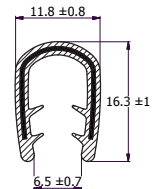

Type 6

### Type 1

Part Number	Clamping Range (mm)	Colour	Roll Length (m)
34009590001	1 - 1.5 MM	Black	20
34009590002	1 - 1.5 MM	Grey	20
34009590003	1 - 1.5 MM	White	20

### Type 2

Part Number	Clamping Range (mm)	Colour	Roll Length (m)
34009504001	1 - 2 MM	Black	20
34009504002	1 - 2 MM	Grey	20
34009504003	1 - 2 MM	White	20

### Type 3

Part Number	Clamping Range (mm)	Colour	Roll Length (m)
34009507001	1.5 - 3 MM	Black	20
34009507002	1.5 - 3 MM	Grey	20
34009507003	1.5 - 3 MM	White	20

### Type 4

Part Number	Clamping Range (mm)	Colour	Roll Length (m)
34009516001	1 - 3 MM	Black	20
34009516002	1 - 3 MM	Grey	20
34009516003	1 - 3 MM	White	20

### Type 5

Part Number	Clamping Range (mm)	Colour	Roll Length (m)
34009530001	2 - 4 MM	Black	20
34009530002	2 - 4 MM	Grey	20
34009530003	2 - 4 MM	White	20

### Type 6

Part Number	Clamping Range (mm)	Colour	Roll Length (m)
34009628001	6 - 8 MM	Black	20
34009628002	6 - 8 MM	Grey	20
34009628003	6 - 8 MM	White	20

**PVC Edge Protector** CONTINUED

**Black PVC with steel spring core**

- Supplied in rolls of 20m
- Provides protection to steel edges
- Profiles are flexible and pressed on by hand
- Suitable for -20°C to 90°C

**Type 7**

Part Number	Clamping Range	Colour	Roll Length (m)
34009901001	1 - 3 MM	Black	20
34009901002	1 - 3 MM	Grey	20
34009901003	1 - 3 MM	White	20

**Type 8**

Part Number	Clamping Range	Colour	Roll Length (m)
34009802001	1.5 - 3 MM	Black	20
34009802002	1.5 - 3 MM	Grey	20
34009802003	1.5 - 3 MM	White	20

**Type 9**

Part Number	Clamping Range	Colour	Roll Length (m)
34009701001	1 - 2 MM	Black	20
34009701002	1 - 2 MM	Grey	20
34009701003	1 - 2 MM	White	20

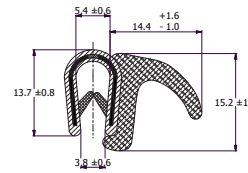

Type 7

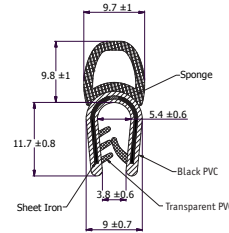

Type 8

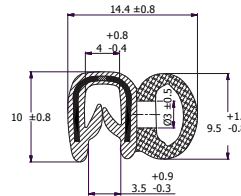

Type 9

**Dual-Hard Self Adhesive**

SR 6491

Solid Black EPDM @ 70° Shore A

Expanded Black EPDM @ 0.65g.ccm S.G.

- Used in industrial and automotive applications
- Ideal in areas of high dynamic uses exposed to rigorous daily demands
- High bond taped profile allows an instant fix and is intended as a permanent attachment
- Tolerances ISO 3302-1 1996 Class E-2 / E-3

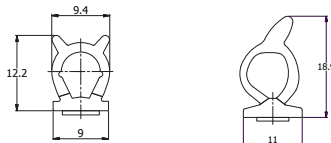

Part Number	Roll Length (m)
551824	20
551825	20

**Steel Inserted Side Bubble Gasket**

SR 6490

Solid Black EPDM @ 70° Shore A

Expanded Black EPDM @ 0.65g.ccm S.G.

- Robustly designed profile for dynamic sealing
- Typically used as door seals on larger heavy duty vehicles
- Steel insert provides an increased grip which is resistant against high vibration

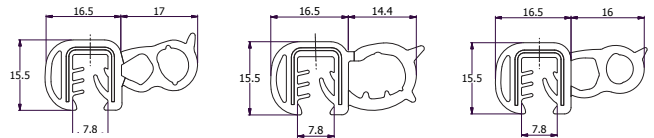

Part Number	Roll Length (m)
551826	20
551827	20
551828	20

## S Profile Glazing Gasket

SR 6489

Solid black EPDM at 60° Shore A

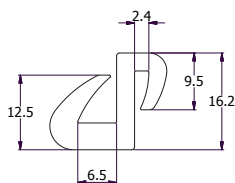
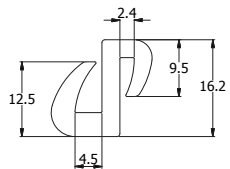

- Easy to fit, used for sealing windows, inspection panel
- Used in lightweight applications
- Ideal when glass or acrylic panels are not subjected to high pressures or exposure to external weather elements
- Tolerances ISO 3302-1 1996 Class E-2

### Type 1

Part Number	Roll Length (m)
551829	20

### Type 2

Part Number	Roll Length (m)
551830	20

## Glazing Gasket

SR 6488

Solid Black EPDM at 70° Shore A

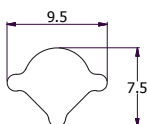
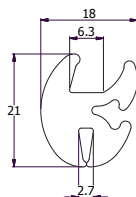
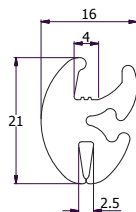
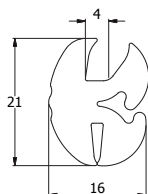

- Easy to fit glazing solution for windows and inspection panels
- Effective weatherproof seal, can be used where there are rigorous environmental demands
- 551834 is the zipper profile and needs to be ordered with Type 1 & 3. Type 2 is supplied with the zipper profile.

### Type 1

Part Number	Roll Length (m)
551831	20

### Type 2

Part Number	Roll Length (m)
551832	20

### Type 3

Part Number	Roll Length (m)
551833	20

### Zipper Profile

Part Number	Roll Length (m)
551834	20

## Round Cord Gasket

SR 6487

EPDM



Part Number		Dimension (mm)	Roll Length
EPDM Sponge	EPDM Solid	∅	(m)
551808	551816	2.5	10
551809	551817	3.0	10
551810	551818	4.0	10
551811	551819	5.0	10
551812	551820	6.0	10
551813	551821	8.0	10
551814	551822	9.5	10
551815	551823	12.0	10

## EMI Gasketing

SR 6500

Polyurethane foam covered in nickel-copper tape.

- EMI Gasket reduce radiated emissions from boxes and enclosures.
- Wide bandwidth response 0.1-180 GHz
- High noise reducing characteristics 80-90dB
- Low Resistivity 0.8 Ω-cm
- Adhesive base for simple installation
- Maximum uncut length 1 metre

### Type 1

Part Number	Dimensions (mm)			Compression Range	Mounting	Fire Rating	Standard Pack Qty (5 X 1M)
	A	B	C				
552044	10.7	9.8	5	10-25%	Adhesive Tape-Non Conductive	V-0	5

### Type 2

Part Number	Dimensions (mm)			Compression Range	Mounting	Fire Rating	Standard Pack Qty (5 X 1M)
	A	B	C				
552045	12.7	12.7	5	10-25%	Adhesive Tape-Non Conductive	V-0	5

### Type 3

Part Number	Dimensions (mm)			Compression Range	Mounting	Fire Rating	Standard Pack Qty (5 X 1M)
	A	B	C				
552046	9.5	6.4	5	10-25%	Adhesive Tape-Non Conductive	V-0	5

### Type 4

Part Number	Dimensions (mm)			Compression Range	Mounting	Fire Rating	Standard Pack Qty (5 X 1M)
	A	B	C				
552047	12.7	6.4	5	10-25%	Adhesive Tape-Non Conductive	V-0	5

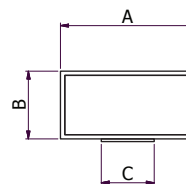
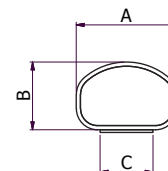
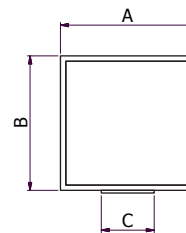
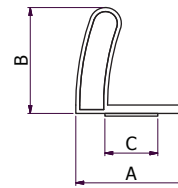

# DRAWER SLIDES, GAS STRUTS AND LID STAYS

## Industrial Drawer Slides

SR2500/SR5492/SR5491

Zinc Plated Steel



### SR 2500/SR 5491

- Front Disconnect
- Full Extension
- Packed in pairs

Part Number		Dimensions (mm)			Std Pack Qty (Pairs)
Zinc Plated Steel	Stainless Steel	Slide Length (mm)	Slide Extension (mm)	Width (mm)	
D2000250A	497889	250	250	45	6
D2000300A	497890	300	300	45	6
D2000350A	497891	350	350	45	6
D2000400A	497892	400	400	45	6
D2000450A	497893	450	450	45	6
D2000500A	497894	500	500	45	6
D2000550A	497895	550	550	45	6
D2000600A	497896	600	600	45	6
D2000650A	497897	650	650	45	4
D2000700A	497898	700	700	45	4

### SR 5492

- 3/4 Extension
- Packed in pairs

Part Number	Dimensions (mm)			Std Pack Qty (Pairs)
	Slide Length (mm)	Slide Extension (mm)	Width (mm)	
497899	250	168	35	6
497900	306	215	35	6
497901	350	255	35	6
497902	400	295	35	6
497903	450	330	35	6
497904	500	375	35	6
497905	557	415	35	6
497906	610	462	35	6
497907	660	494	35	4
497908	710	522	35	4

For drawings showing fixing positions, please visit our website or call our customer service team

**Light/Medium Duty Drawer Slides**

SR 5494

Zinc Plated Steel

**Light Duty**

- 3/4 Extension
- Ideal for use in toolboxes, store fixtures and laboratory furniture
- Packed in pairs

Part Number	Slide Length (mm)	Slide Extension (mm)	Width (mm)	Std Pack Qty (Pairs)
AI-0416	400	281	35	6
AI-0418	450	331	35	6
AI-0420	500	376	35	6
AI-0422*	550	415	35	6

\* alternative design - see web for drawing

**Medium Duty**

- Full Extension
- Ideal for use in medium duty box drawers, store fixtures and furniture
- Packed in pairs

Part Number	Slide Length (mm)	Slide Extension (mm)	Width (mm)	Std Pack Qty (Pairs)
AI-0614	350	357	26.3	6
AI-0616	400	406	26.3	6
AI-0620	500	505	26.3	6

- 3/4 Extension
- Ideal for use in displays, workstations or medical equipment
- Packed in pairs

Part Number	Slide Length (mm)	Slide Extension (mm)	Width (mm)	Std Pack Qty (Pairs)
AI-0718	457	330	35	6
AI-0720	508	381	35	6

For drawings showing fixing positions, please visit our website or call our customer service team



# DRAWER SLIDES, GAS STRUTS AND LID STAYS

## Adjustable Force Gas Struts

SR 5487

Rod: Steel

Fittings: Nylon/Steel

- Widely used in industries such as medical & laboratory, furniture, automotive and industrial equipment for opening, closing, tilting and damping

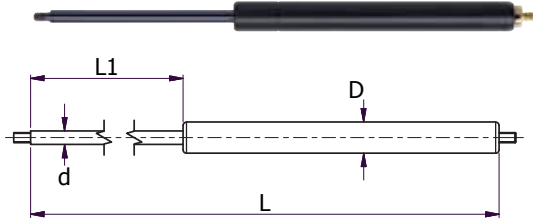

- No need to calculate force
- Force can be adjusted after installation - saves time and effort
- Simple adjustment using standard tool supplied
- Ideal for prototyping and short production runs
- Ideal where application weights vary
- Supplied fitted with ball joints and eye fittings in pack
- Supplied in pairs
- 1 pack contains:
  - 2 x Gas struts
  - 4 x Ball joints
  - 4 x Eyes
  - 1 x Allen Key
  - 1 x Instruction leaflet



### Rods without fittings

Part Number	Rod Diameter d (mm)	Piston Diameter D (mm)	Stroke Length L1 (mm)	Extended Length L (mm)	Static Force (N)	+/- (N)	Ball Joints	Eyes	Std Pack Qty
497819	6	15	40	115	400	20	Nylon	Nylon	1
1253217	6	15	60	160	400	20	Nylon	Nylon	1
1253218	6	15	100	240	400	20	Nylon	Nylon	1
1253219	6	15	150	340	400	20	Nylon	Nylon	1
1253220	6	15	200	440	400	20	Nylon	Nylon	1
497820	8	18	80	210	650	33	Steel	Nylon	1
497821	8	18	100	250	650	33	Steel	Nylon	1
1253221	8	18	100	264	650	33	Steel	Nylon	1
497822	8	18	120	290	650	33	Steel	Nylon	1
497823	8	18	150	350	650	33	Steel	Nylon	1
1253222	8	18	150	364	650	33	Steel	Nylon	1
497824	8	18	160	370	650	33	Steel	Nylon	1
497825	8	18	180	410	650	33	Steel	Nylon	1
1253223	8	18	200	464	650	33	Steel	Nylon	1
1253224	8	18	250	564	650	33	Steel	Nylon	1
1253226	10	23	100	245	1200	60	Steel	Zinc	1
497826	10	23	100	250	1200	60	Steel	Zinc	1
497827	10	23	150	350	1200	60	Steel	Zinc	1
1253227	10	23	200	445	1200	60	Steel	Zinc	1
497828	10	23	200	450	1200	60	Steel	Zinc	1
1253225	10	23	250	545	1200	60	Steel	Zinc	1
1253228	10	23	300	645	1200	60	Steel	Zinc	1
497829	10	23	300	650	1200	60	Steel	Zinc	1
1253229*	14	28	200	480	2500	125	Steel	-	1
1253230*	14	28	300	680	2500	125	Steel	-	1
497830*	14	28	400	860	2500	125	Steel	-	1
1253231*	14	28	400	880	2500	125	Steel	-	1
1253232*	14	28	500	1080	2500	125	Steel	-	1

\*Supplied with ball joints only



### Ball Joints

To Fit Rod Dia. (mm)	Dimensions (mm)			
	L	h	h1	d
6	17.5	10.3	9	M5x0.8-6g
8	18.0	12.5	12	M8x1.25-6g
10	30.0	16.5	13	M8x1.25-6g
14	35.0	20.0	16	M10x1.5-6g

### Eyes

To Fit Rod Dia. (mm)	Dimensions (mm)			
	L	D	d	t
6	17	9	6.1	8
8	21	14	8.3	10
10	21	14	10.3	10

## Fixed Force Gas Struts

SR 6482

Rod: steel

Material finish: Rod - Black nitrided; Tube - Black epoxy powder coated

- Self-contained, maintenance free
- Safe to use with easy positional control
- Suited for use on applications such as acces panels, lids bonnets and hatch covers

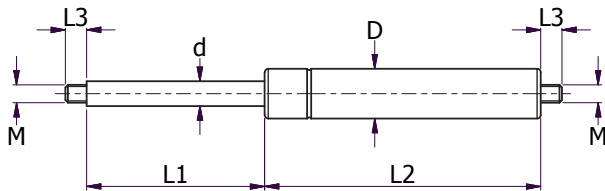

Part Number	Rod Ø d (mm)	Piston Ø D (mm)	Stroke L1 (mm)	Piston L2 (mm)	Fixed Force (N)	± (N)	Thread M	L3 (mm)	Std Pack Qty
551870	6	15	60	90	50	10	M5	10	10
551871	6	15	60	90	100	5	M5	10	10
551872	6	15	60	90	150	8	M5	10	10
551873	6	15	60	90	250	13	M5	10	10
551874	6	15	100	130	150	8	M5	10	10
551875	6	15	100	130	200	10	M5	10	10
551876	6	15	100	130	300	15	M5	10	10
551877	6	15	100	130	400	20	M5	10	10
551878	6	15	150	180	50	10	M5	10	10
551879	6	15	150	180	100	5	M5	10	10
551880	6	15	150	180	150	8	M5	10	10
551881	6	15	150	180	250	13	M5	10	10
551882	6	15	200	230	100	5	M5	10	10
551883	6	15	200	230	200	10	M5	10	10
551884	6	15	200	230	300	15	M5	10	10
551885	6	15	200	230	400	20	M5	10	10
551886	8	18	100	145	100	5	M6	10	10
551887	8	18	100	145	150	8	M6	10	10
551888	8	18	100	145	200	10	M6	10	10
551889	8	18	100	145	250	13	M6	10	10
551890	8	18	100	145	350	18	M6	10	10
551891	8	18	100	145	450	23	M6	10	10
551892	8	18	100	145	550	28	M6	10	10
551893	8	18	100	145	650	33	M6	10	10
551894	8	18	150	195	150	8	M6	10	10
551895	8	18	150	195	250	13	M6	10	10
551896	8	18	150	195	300	15	M6	10	10
551897	8	18	150	195	350	18	M6	10	10
551898	8	18	150	195	400	20	M6	10	10
551899	8	18	150	195	450	23	M6	10	10
551900	8	18	150	195	500	25	M6	10	10
551901	8	18	150	195	550	28	M6	10	10
551902	8	18	150	195	600	30	M6	10	10
551903	8	18	150	195	650	33	M6	10	10
551904	8	18	200	245	100	5	M6	10	10
551905	8	18	200	245	150	8	M6	10	10
551906	8	18	200	245	200	10	M6	10	10
551907	8	18	200	245	250	13	M6	10	10
551908	8	18	200	245	350	18	M6	10	10
551909	8	18	200	245	450	23	M6	10	10

CONTINUED ON NEXT PAGE

# DRAWER SLIDES, GAS STRUTS AND LID STAYS

## Fixed Force Gas Struts *CONTINUED*

SR 6482

Rod: steel

Material finish: Rod - Black nitrided; Tube - Black epoxy powder coated

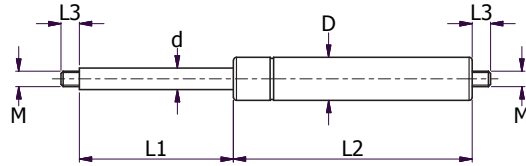

Part Number	Rod Ø d (mm)	Piston Ø D (mm)	Stroke L1 (mm)	Piston L2 (mm)	Fixed Force (N)	± (N)	Thread M	L3 (mm)	Std Pack Qty
551910	8	18	200	245	550	28	M6	10	10
551911	8	18	200	245	650	33	M6	10	10
551912	8	18	250	295	150	8	M6	10	10
551913	8	18	250	295	250	13	M6	10	10
551914	8	18	250	295	300	15	M6	10	10
551915	8	18	250	295	350	18	M6	10	10
551916	8	18	250	295	400	20	M6	10	10
551917	8	18	250	295	450	23	M6	10	10
551918	8	18	250	295	500	25	M6	10	10
551919	8	18	250	295	550	28	M6	10	10
551920	8	18	250	295	600	30	M6	10	10
551921	8	18	250	295	650	33	M6	10	10
551922	10	23	100	145	200	10	M8	12	10
551923	10	23	100	145	400	20	M8	12	10
551924	10	23	100	145	600	30	M8	12	10
551925	10	23	100	145	800	40	M8	12	10
551926	10	23	100	145	1000	50	M8	12	10
551927	10	23	100	145	1200	60	M8	12	10
551928	10	23	150	195	250	13	M8	12	10
551929	10	23	150	195	350	18	M8	12	10
551930	10	23	150	195	500	25	M8	12	10
551931	10	23	150	195	700	35	M8	12	10
551932	10	23	150	195	850	43	M8	12	10
551933	10	23	150	195	1000	50	M8	12	10
551934	10	23	200	245	200	10	M8	12	10
551935	10	23	200	245	300	15	M8	12	10
551936	10	23	200	245	400	20	M8	12	10
551937	10	23	200	245	600	30	M8	12	10
551938	10	23	200	245	900	45	M8	12	10
551939	10	23	200	245	1100	55	M8	12	10
551940	10	23	250	295	400	20	M8	12	10
551941	10	23	250	295	500	25	M8	12	10
551942	10	23	250	295	650	33	M8	12	10
551943	10	23	250	295	800	40	M8	12	10
551944	10	23	250	295	900	45	M8	12	10
551945	10	23	250	295	1000	50	M8	12	10
551946	10	23	300	345	350	18	M8	12	10
551947	10	23	300	345	550	28	M8	12	10
551948	10	23	300	345	750	38	M8	12	10
551949	10	23	300	345	850	43	M8	12	10
551950	10	23	300	345	1000	50	M8	12	10
551951	10	23	300	345	1200	60	M8	12	10

CONTINUED ON NEXT PAGE

## Fixed Force Gas Struts *CONTINUED*

SR 6482

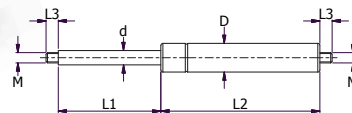

Part Number	Rod Ø d (mm)	Piston Ø D (mm)	Stroke L1 (mm)	Piston L2 (mm)	Fixed Force (N)	± (N)	Thread M	L3 (mm)	Std Pack Qty
551952	14	28	100	155	500	25	10	12	10
551953	14	28	100	155	750	38	10	12	10
551954	14	28	100	155	1000	50	10	12	10
551955	14	28	100	155	1250	63	10	12	10
551956	14	28	100	155	1750	88	10	12	10
551957	14	28	200	255	750	38	10	12	10
551958	14	28	200	255	1000	50	10	12	10
551959	14	28	200	255	1250	63	10	12	10
551960	14	28	200	255	1500	75	10	12	10
551961	14	28	200	255	2000	100	10	12	10
551962	14	28	250	555	500	25	10	12	10
551963	14	28	250	555	750	38	10	12	10
551964	14	28	250	555	1000	50	10	12	10
551965	14	28	250	555	1250	63	10	12	10
551966	14	28	250	555	1750	88	10	12	10

## Multi-Position Gas Strut

Rod: Steel

Fittings: Nylon/Steel

- Multi-position holding of counter-balanced weights
- Customisable external friction adjustment
- Positional control
- Safe to use and operate
- Maintenance free
- 1 pack contains:
  - 2 x Gas strut fitted with ball joints
  - 4 x eyes
  - 1 x Allen Key
  - 1 x Instruction leaflet

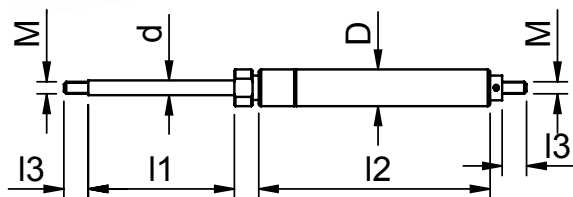

Part Number	Rod Diameter d (mm)	Piston Diameter D (mm)	Stroke Length l1 (mm)	Extended Length l2 (mm)	Static Force (N)	+/- (N)	Ball Joints	Eyes	Std Pack Qty
1253207	6	15	60	170	400	20	Nylon	Nylon	1
1253208	6	15	100	250	400	20	Nylon	Nylon	1
1253209	6	15	150	350	400	20	Nylon	Nylon	1
1253210	6	15	200	450	400	20	Nylon	Nylon	1
1253211	8	18	100	264	650	33	Steel	Nylon	1
1253212	8	18	150	364	650	33	Steel	Nylon	1
1253213	8	18	200	464	650	33	Steel	Nylon	1
1253214	8	18	250	564	650	33	Steel	Nylon	1
1253215	10	23	250	560	1200	60	Steel	Zinc	1
1253216	10	23	300	660	1200	60	Steel	Zinc	1

# DRAWER SLIDES, GAS STRUTS AND LID STAYS

## Stainless Steel Gas Struts

Rod: 316 Stainless Steel

Fittings: Nylon



- High corrosion resistance for external applications
- 1000 hours salt spray tested
- 316L stainless steel tube & rod
- Additional hardness & corrosion resistance via special surface finish
- Supplied in Pairs
- 1 pack contains:
  - 2 x Gas strut fitted with Nylon ball joints
  - 4 x Nylon eyes
  - 1 x Allen Key
  - 1 x Instruction leaflet

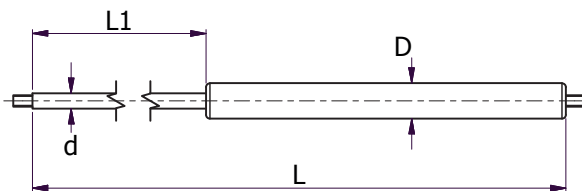

Part Number	Rod Diameter d (mm)	Piston Diameter D (mm)	Stroke Length L1 (mm)	Extended Length L (mm)	Static Force (N)	+/- (N)	Std Pack Qty
1253243	6	15	60	160	400	20	1
1253245	6	15	100	240	400	20	1
1253244	6	15	150	340	400	20	1
1253246	6	15	200	440	400	20	1
1253247	8	18	100	264	650	33	1
1253249	8	18	150	364	650	33	1
1253248	8	18	200	464	650	33	1
1253250	8	18	250	564	650	33	1
1253251	8	18	300	664	650	33	1
1253252	10	23	100	245	1200	60	1
1253253	10	23	200	445	1200	60	1
1253254	10	23	250	545	1200	60	1
1253255	10	23	300	645	1200	60	1
1253256	14	28	200	480	2500	125	1
1253257	14	28	300	680	2500	125	1

## YES, WE CAN CUSTOMISE YOUR GAS STRUT

We're more than what you'll find within these pages. Our expertise, knowledge and experience means we can design and build a bespoke gas strut that perfectly suits your needs.

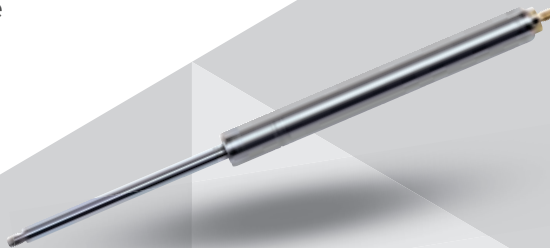

## Safety Locking-Shroud Gas Springs

Rod: Steel

Fittings: Nylon/Steel

- Eliminates the need for separate safety rods in critical lift-assist operations
- Operates automatically
- Safe & easy to use
- Self-contained unit
- Maintenance free
- Supplied in Pairs
- 1 pack contains:
  - 2 x Gas strut (1 safety & 1 adjustable force) fitted with ball joints
  - 4 x Nylon eyes
  - 1 x Allen Key
  - 1 x Instruction leaflet

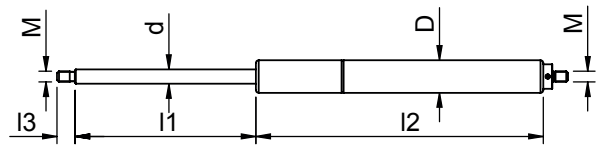

Part Number	Rod Diameter d (mm)	Piston Diameter D (mm)	Stroke Length l1 (mm)	Extended Length l2 (mm)	Static Force (N)	+/- (N)	Std Pack Qty
1253233	8	18	100	264	650	33	1
1253234	8	18	150	364	650	33	1
1253235	8	18	200	464	650	33	1
1253236	8	18	250	564	650	33	1
1253237	8	18	300	664	650	33	1
1253238	10	23	200	465	1200	60	1
1253239	10	23	300	665	1200	60	1
1253240	14	28	200	480	2500	125	1
1253241	14	28	300	680	2500	125	1
1253242	14	28	400	880	2500	125	1

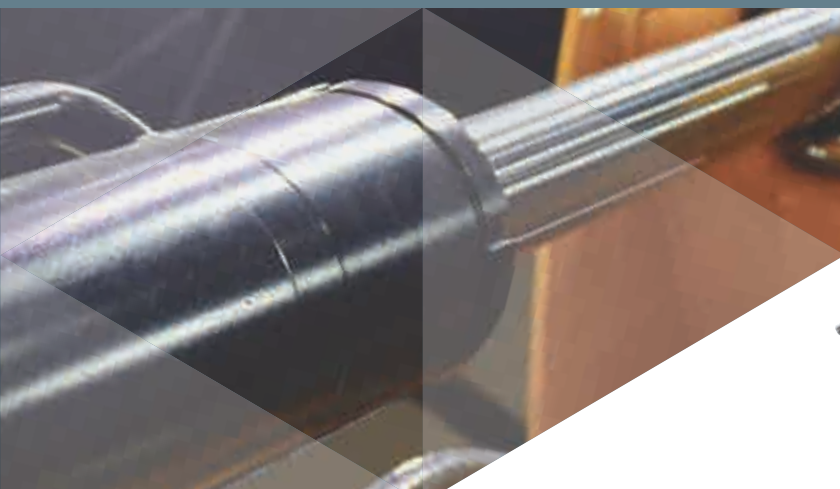

To learn more:

**Call 0845 758 5070**

[www.essentracomponents.co.uk](http://www.essentracomponents.co.uk)

# DRAWER SLIDES, GAS STRUTS AND LID STAYS

## End Fittings

SR 6481

- Different designs and sizes for flexibility of mounting
- Designed to suit your application
- Maintenance free

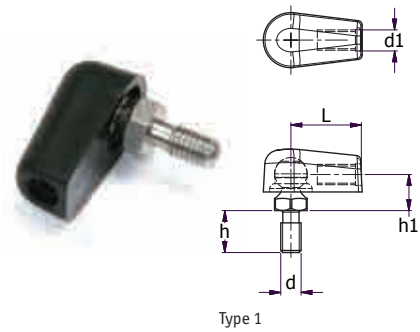

Type 1

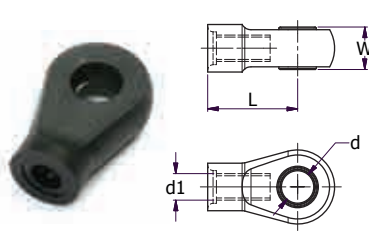

Type 2

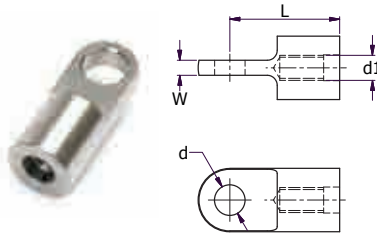

Type 3

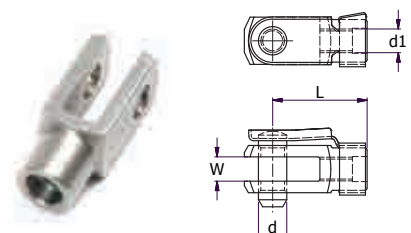

Type 4

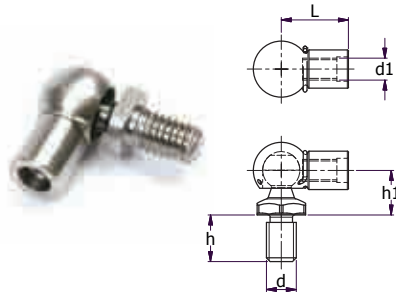

Type 5

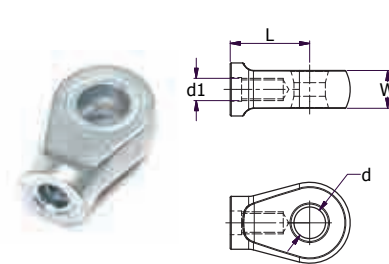

Type 6

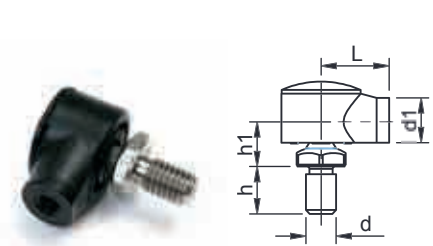

Type 7

Part Number	Material	Type	To fit Gas Strut Ø	Dimensions (mm)						Std Pack Qty
				d	d1	h	h1	W	L	
552018	Nylon	1	6-15	M5x0.8	M5x0.8	10.3	9.0	-	17.5	25
552024	Nylon	1	8-18	-	M6x1.0	-	-	-	17.5	25
552019	Nylon	2	6-15	6.1	M5x0.8	-	-	8.075	17.0	25
552026	Nylon	2	8-18	8.1	M6x1.0	-	-	10.0	21.0	25
552020	Steel	3	6-15	6.1	M5x0.8	-	-	3.0	22.0	25
552035	Steel	3	14-28	10.0	M10x1.5	-	-	10.2	32.0	25
1253202	Stainless Steel	3	-	8.0	M6x1.0	-	-	5.0	25.0	4
1253205	Stainless Steel	3	-	-	M6x 1.0	-	-	8.0	32.0	4
552021*	Steel	4	6-15	5.0	M5x0.8	-	-	5.2	20.0	25
552028*	Steel	4	8-18	6.0	M6x1.0	-	-	6.3	24.0	25
552032*	Steel	4	10-23	8.0	M8x1.25	-	-	8.2	32.0	25
552036*	Steel	4	14-28	10.0	M10x1.5	-	-	10.3	37.0	25
1253201	Stainless Steel	4	8-18	6.0	M6x 1.0	-	-	6.3	24.0	4
1253206	Stainless Steel	4	10-23	8.0	M6x1.0	-	-	8.2	32.0	4
552023	Steel	5	8-18	M8x1.25	M6x1.0	12.5	12.0	-	18.0	25
552025	Steel	5	8-18	M8x1.25	M8x1.25	16.5	13.0	-	30.0	25
552030	Steel	5	10-23	M10x1.5	M10x1.5	20.0	16.0	-	35.0	25
552034	Steel	5	14-28	-	M6x1.0	-	-	-	18.0	25
1253201	Stainless Steel	5	8-18	M8x1.25	M6x1.0	12.5	12.0	-	18.0	4
1253204	Stainless Steel	5	8-18	M8x1.25	M8x1.25	16.5	13.0	-	30.0	4
552027	Zinc	6	8-18	8.3	M6x1.0	-	-	10.0	21.0	25
552031	Zinc	6	10-23	10.3	M8x1.25	-	-	10.0	21.0	25
1253200	Nylon	7	-	12	M8x 1.25	12.5	12	-	18.0	4

\*add plated steel locking clip

552021 with 552022, 552032 with 552033

552028 with 552029,

552036 with 552037

## Mounting Brackets

SR 6480

Carbon steel with zinc and clear passivate

- Easy installation
- A wide range of end fit options available
- Salt spray tested under ASTM B 117
- Designed to accept DIN/ISO standard fixings
- Suitable for gas strut size 8-18 diametre

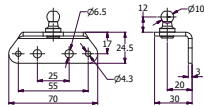

Type 1

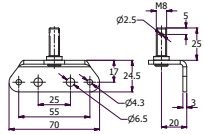

Type 2

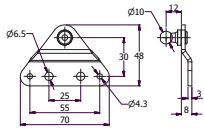

Type 3

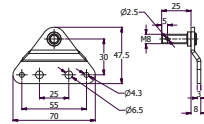

Type 4

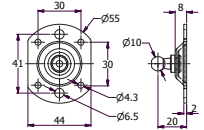

Type 5

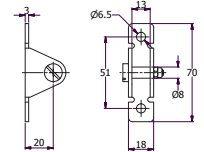

Type 6



### 90° Plated

Part Number	Type	Fit	Std Pack Qty
552039	1	Ball Joint	25
552043	2	Eyes Clevis Fork	25

### Flat Plated

Part Number	Type	Fit	Std Pack Qty
552038	3	Ball Joint	25
552041	4	Eyes Clevis Fork	25

### Raised and U-Plated

Part Number	Type	Fit	Std Pack Qty
552040	5	Ball Joint	25
552042	6	Eyes Clevis Fork	25

## Folding Lid Stays

Carbon Steel with Clear Passivate



- Easy installation & simple to operate
- Supports up to 135kg
- Maintenance free
- Up to 10 adjustment positions
- Stops at any holding position

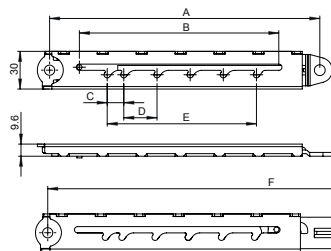

Part Number	Number of positions	A (mm)	B (mm)	C (mm)	D (mm)	E (mm)	F (mm)	Std Pack Qty
1253258	5	141	87	13	13	52	231	10
1253259	10	215	159	13	13	117	373	10
1253260	6	215	155	14	26	118	373	10



# DRAWER SLIDES, GAS STRUTS AND LID STAYS

## Medium Duty Lid Stays

SR 5553

Steel - Zinc Plated Finish / 304 Stainless Steel



- Available in left or right-handed versions
- Ideal for holding open lids, electric panel and inspection covers, etc
- Drilled for screws of  $\varnothing 5\text{mm}$

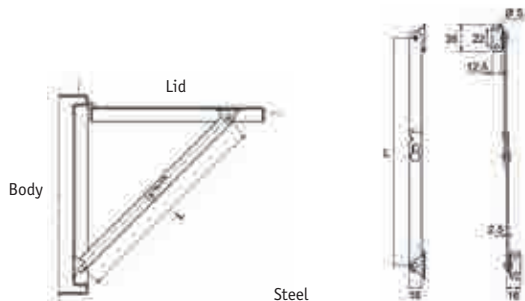

### Steel

Part Number		L (mm)	Std Pack Qty
Left Hand	Right Hand		
07963135002E	07963135001E	135	50
07963202002E	07963202001E	202	50
07963292002E	07963292001E	292	50

### Stainless Steel

Part Number		L (mm)	Std Pack Qty
Left Hand	Right Hand		
07940135002E	07940135001E	135	50
07940202002E	07940202001E	202	50
07940292002E	07940292001E	292	50

## Heavy Duty Lid Stays

SR5571

Steel or 304 Stainless Steel



- 4mm Thick
- Suitable for heavy duty applications
- Ideal for heavy lids, electrical panels or machinery covers

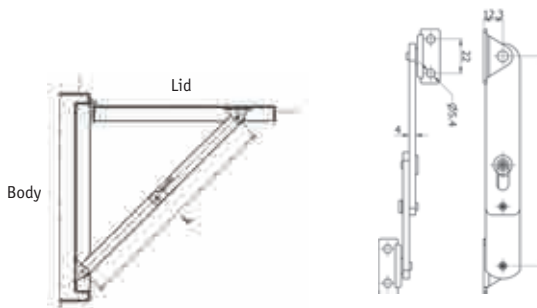

### Steel

Part Number		L (mm)	Std Pack Qty
Left Hand	Right Hand		
27963135002E	27963135001E	135	20
27963202002E	27963202001E	202	20
27963292002E	27963292001E	292	20

### Stainless Steel

Part Number		L (mm)	Std Pack Qty
Left Hand	Right Hand		
27940135002E	27940135001E	135	20
27940202002E	27940202001E	202	20
27940292002E	27940292001E	292	20

## Automatic Locking Lid Stay

SR 5572

Steel / 304 Stainless Steel

- Stay will automatically lock to keep door open
- Can be used as left or right hand

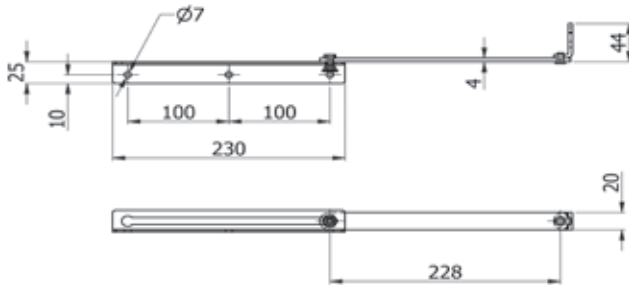

Part Number	Type	Std Pack Qty
17940E	Stainless Steel	20
17963E	Steel	20

## Door Holdback

NBR Rubber

- Provides good shock absorbing properties while the door contacts with the frame of the cabinet
- Keeps the door at open position and can be used instead of cover stays
- Suitable for outdoor cabinets with high corrosion resistance
- Ideal for generators, compressors and machinery covers
- Made from NBR Rubber

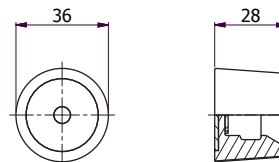
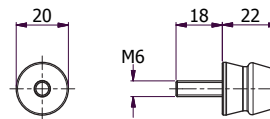

Part Number	Std Pack Qty
34008001	5

# DRAWING POCKETS AND COUNTER SCREENS

## Counter Screens / Inspection Window

SR 5570

ABS

- Allows counters, dials and instruments to be viewed from outside the enclosure
- Supplied with a sealing o-ring

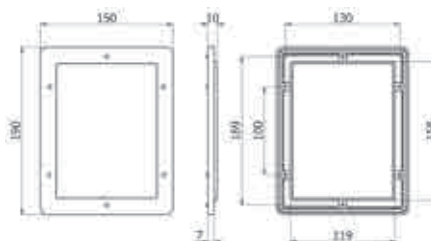

Large

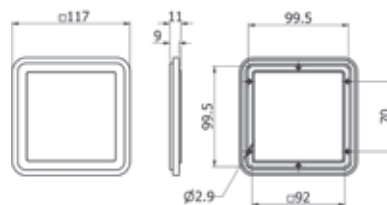

Small

Part Number	Type	Std Pack Qty
2215E	Small	10
2216E	Large	10

## Drawing Pocket

SR 5522

Beige ABS

- Type 1: For use with A4 size documents
- Type 2: For use with A5 size documents
- Self-adhesive strips for quick attachment
- Typical applications include machinery covers & electric panels

Type 1

Type 2



Type 1

Type 2

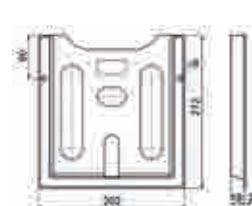
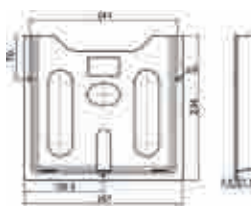

Part Number	Type	Style	Std Pack Qty
2150E	1	A4	50
2152E	2	A5	100

# GO ONLINE TO SEE OUR TOGGLE CLAMP RANGE

Looking for toggle clamps? They're now part of our online-only range. Vertical or horizontal, stainless steel or neoprene – we make it easy to get what you need with fast despatch and outstanding customer service.

You'll also find our toggle clamp plier and coolant hose online, so check them out now at [www.essentracomponents.co.uk](http://www.essentracomponents.co.uk)



To learn more:  
Call: 0845 758 5070

Email: [sales@essentracomponents.co.uk](mailto:sales@essentracomponents.co.uk)