

JUMO GmbH & Co. KG
 Delivery address: Mackenrodtstraße 14,
 36039 Fulda, Germany
 Postal address: 36035 Fulda, Germany
 Phone: +49 661 6003-0
 Fax: +49 661 6003-607
 E-mail: mail@jumo.net
 Internet: www.jumo.net

JUMO Instrument Co. Ltd.
 JUMO House
 Temple Bank, Riverway
 Harlow, Essex CM20 2DY, UK
 Phone: +44 1279 635533
 Fax: +44 1279 635262
 E-mail: sales@jumo.co.uk
 Internet: www.jumo.co.uk

JUMO Process Control, Inc.
 8 Technology Boulevard
 Canastota, NY 13032, USA
 Phone: 315-697-JUMO
 1-800-554-JUMO
 Fax: 315-697-5867
 E-mail: info@jumo.us
 Internet: www.jumo.us



JUMO cTRON 04/08/16

Compact controller with timer and ramp function

Brief description

This series of controllers consists of three, freely configurable and universally applicable compact controllers in various DIN formats for controlling temperature, pressure and other process variables. The main areas of application are heating cabinets, temperature stabilizing and cooling systems, drying and freezing systems and laboratory furnaces and sterilizers in the food, plastics and packaging industries.

With all models, one red and one green seven-segment LED display are used to display process values and parameters. There are a further seven LEDs available to display switch positions, manual mode, ramp function and timer mode. Operation is by four keys on the front panel.

Depending on the hardware configuration, the instruments can be used as 2-state controllers, 3-state controllers, modulating controllers or continuous controllers. Self-optimization, ramp function with adjustable gradients, manual mode, power ON delay, two limit comparators, extensive timer functions and a service counter are included, even in the basic version.

Each instrument has a universal measurement input for an RTD temperature probe, a thermocouple and standard signals (current, voltage); linearizations of more than 20 sensors are stored. All types are equipped with at maximum two binary inputs, one logic output and two relay outputs. In addition every type can optionally be delivered with a third relay output or an analog output.

A setup interface is available as standard for configuration with the setup program (option). The instruments can be integrated into a data network (Modbus) via an optional RS485 interface.

Electrical connection is at the rear, via screw terminals (pluggable terminal strips).



JUMO cTRON 16
Type 702071/ ...



JUMO cTRON 08
Type 702072/ ...



JUMO cTRON 04
Type 702074/ ...

Block structure

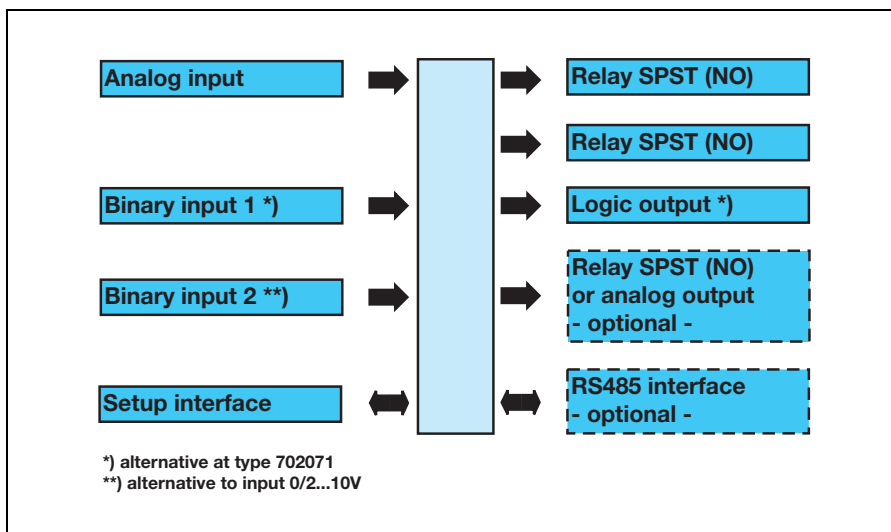

Features

- Programmable user level
- Setpoint changeover
- Ramp function
- Power ON delay
- 2 limit comparators
- Timer function
- Self-optimization
- Service counter
- Fast, user-friendly configuration with the setup program (accessory)
- RS485 interface (optional)

Approvals/marks of conformity (see Technical data)



2009-09-22/00492540

Self-optimization

Standard features include tried and tested self-optimization (oscillatory method), which makes it possible for the controller to be matched to the control loop by a user who is not a control technology expert. The response of the control loop to specific changes in the manipulating variables is evaluated and the controller parameters of proportional band, reset time, derivative time, cycle time and filter time constant are calculated.

User level

Parameters which are frequently changed by the user can be combined at the specially created user level (in the setup program). The operating level available as a factory setting is then hidden.

Binary functions

- Start/cancel self-optimization
 - Change to manual mode
 - Manual mode locking
 - Controller off/on
 - Hold/cancel/reset ramp
 - Setpoint changeover
 - Keyboard/level inhibit
 - Display off
 - Acknowledge limit comparators
 - Acknowledge timer
 - Start/hold/cancel timer
- The binary functions can be combined with one another (in the setup program).

Functions of the outputs

- Analog input variable
- Process value, setpoint
- Ramp end value, setpoint
- Output level, controller outputs
- Timer runtime/time remaining
- Binary inputs
- Limit comparators
- Timer signals
- Tolerance band signal
- Ramp end signal
- Service alarm

Ramp function

The ramp function allows a defined approach of the process value from time t_0 to the setpoint SP. The slope is set by a gradient (Kelvin per minute, per hour or per day) at the configuration level. It is active rising or falling, when the setpoint changes. When the supply voltage is switched on, the ramp function starts with the current process value.

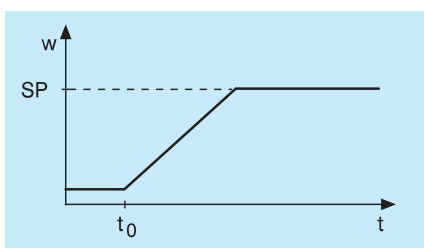

Limit comparators

Two limit comparators are available, each with eight different switching functions. When an alarm value is exceeded, a signal can be output or an internal controller function initiated. Hereby extensive alarm and limit functions can be realized.

Timer

The timer signal can be switched to the binary outputs or processed internally. This allows implementation of time-dependent functions, such as time-limited control or setpoint changeover.

In addition, a time can be specified after the timer ends, to output a time-limited signal after the timer has expired or to specify the duration of time-delayed control.

Service counter

The service counter can monitor the ON period or the switching frequency of a binary signal (of a relay, for example). If a defined limit is exceeded, a signal is generated that can be output at a binary output.

Interfaces

Setup interface

The instrument has a setup interface available as standard. Use this, together with the setup program (accessory) and a setup interface (accessory) to configure the instrument.

RS485 interface

The serial interface is used for communication with higher-level (supervisory) systems. The Modbus protocol is used for transmission.

Setup program

The setup program for configuring the instrument supports several languages (including German, English and French). You can use it to create and edit sets of data and transfer them to the instrument, as well as read them out from it. The data can be stored and printed out. There are additional program modules available to expand the setup program.

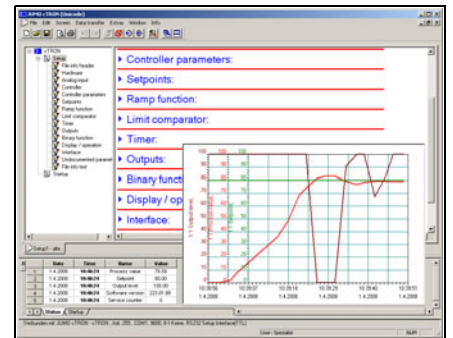

Startup

The startup function is a component of the setup program and is used to record process variables during startup (max. 24 hours). The charts recorded are available on the PC and can be used to document the system, for example.

Displays and controls

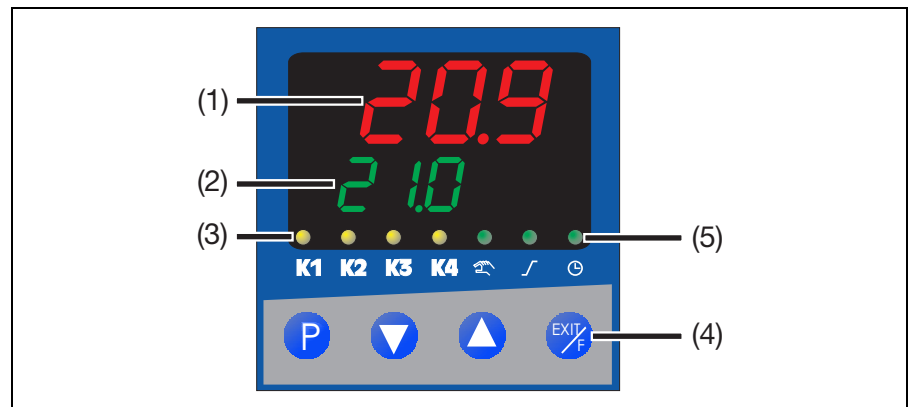

(1)	7-segment display (factory setting: process value) four-digit, red; configurable decimal place (automatic adjustment on display overflow)
(2)	7-segment display (factory setting: setpoint) four-digit, green; configurable decimal place; also used for operator prompting (displaying parameters and level symbols)
(3)	Yellow indicating LED switch positions of binary outputs 1...4 (K1...K4) (display lit = ON)
(4)	Keys programming/one level down; reduce value/previous parameter; increase value/next parameter; exit a level/function key (programmable)
(5)	Green indicating LED manual mode active; ramp function active; timer

Controller parameters

All the parameters are listed in the table, together with their meaning. Some parameters may be missing or inactive for a particular type of controller.

Parameter	Value range	Factory setting	Meaning
Proportional band	0 to 9999 digits	0 digits	Size of the proportional band 0 means that the controller structure is out of action!
Derivative time	0 to 9999sec	80sec	Influences the differential component of the controller output signal
Reset time	0 to 9999sec	350sec	Influences the integral component of the controller output signal
Cycle time	0 to 999.9sec	20.0sec	When using a switched output, the cycle time should be chosen so that the energy flow to the process is as continuous as is practicable without overloading the switching elements.
Contact spacing	0.0 to 999.9 digits	0.0 digits	The spacing between the two control contacts for 3-state or modulating controllers
Switching differential	0.0 to 999.9 digits	1.0 digits	Hysteresis for switching controllers with a proportional band = 0
Actuator time	5 to 3000sec	60sec	Actuator time range used by the control valve for modulating controllers
Working point	-100 to +100%	0%	The output level for P and PD controllers (if x = w, then y = Y0)
Output level limiting	0 to 100%	100%	Maximum limit for the output level
	-100 to +100%	-100%	Minimum limit for the output level

Technical data

Thermocouple input

Designation	Measuring range ²	Measuring accuracy ¹ (incl. cold junction)	Ambient temperature error
Fe-CuNi L	-200 to +900 °C	≤ 0.25%	100ppm/K
Fe-CuNi J EN 60584	-200 to +1200 °C	≤ 0.25%	100ppm/K
Cu-CuNi U	-200 to +600 °C	≤ 0.25%	100ppm/K
Cu-CuNi T EN 60584	-200 to +400 °C	≤ 0.25%	100ppm/K
NiCr-Ni K EN 60584	-200 to +1372 °C	≤ 0.25%	100ppm/K
NiCr-CuNi E EN 60584	-200 to +900 °C	≤ 0.25%	100ppm/K
NiCrSi-NiSi N EN 60584	-100 to +1300 °C	≤ 0.25%	100ppm/K
Pt10Rh-Pt S EN 60584	0 to +1768 °C	≤ 0.25%	100ppm/K
Pt13Rh-Pt R EN 60584	0 to +1768 °C	≤ 0.25%	100ppm/K
Pt30Rh-Pt6Rh B EN 60584	0 to +1820 °C	≤ 0.25% ³	100ppm/K
W5Re-W26Re C	0 to +2320 °C	≤ 0.25%	100ppm/K
W3Re-W25Re D	0 to +2495 °C	≤ 0.25%	100ppm/K
W3Re-W26Re	0 to +2400 °C	≤ 0.25%	100ppm/K
Cold junction	Pt 100, internal		

¹ Accuracy refers to the maximum extent of the measuring range. The linearization accuracy is reduced with short spans.

² The specifications refer to an ambient temperature of 20 °C.

³ in the range 300...1820 °C

Input for RTD temperature probe

Designation	Connection circuit	Measuring range	Measuring accuracy ¹		Ambient temperature error
			3-wire	2-wire	
Pt 100 EN 60751	2-wire / 3-wire	-200 to +850 °C	≤ 0.1%	≤ 0.4%	50ppm/K
Pt 1000 EN 60751	2-wire / 3-wire	-200 to +850 °C	≤ 0.1%	≤ 0.2%	50ppm/K
KTY11-6	2-wire	-50 to +150 °C		≤ 2.0%	50ppm/K
Sensor lead resistance	max. 30Ω per lead for a 3-wire circuit				
Measuring current	approx. 250µA				
Lead compensation	Not required for a 3-wire circuit. With a 2-wire circuit, lead resistance can be compensated by correction of the process value.				

¹ Accuracy refers to the maximum extent of the measuring range. The linearization accuracy is reduced with short spans.

Input for standard signals

Designation	Measuring range	Measuring accuracy ¹	Ambient temperature error
Voltage	0(2) to 10V Input resistance R _E > 100kΩ	≤ 0.1%	100ppm/K
Current	0(4) to 20mA, voltage drop ≤ 2.2V	≤ 0.1%	100ppm/K

¹ Accuracy refers to the maximum extent of the measuring range. The linearization accuracy is reduced with short spans.

Binary inputs

Floating contact	open = inactive; closed = active
------------------	----------------------------------

Measuring circuit monitoring

In the event of a fault, the outputs assume a defined status (configurable).

Sensor	Underrange	Overrange	Probe / lead short-circuit	Probe / lead short-circuit
Thermocouple	•	•	-	•
RTD temperature probe	•	•	•	•
Voltage 2 - 10V 0 - 10V	• -	• •	• -	• -
Current 4 - 20mA 0 - 20mA	• -	• •	• -	• -

• = detected - = not detected

Outputs

Relay SPST (normally open) contact rating contact life	max. 3A at 230V AC resistive load 150,000 operations at rated load/350,000 operations at 1A 310,000 operations at 1A and $\cos \varphi > 0.7$
Logic output	0/14V / 20mA max.
Voltage (option) output signals load resistance accuracy	0 - 10V / 2 - 10V $R_{load} \geq 500\Omega$ $\leq 0.5\%$
Current (option) output signals load resistance accuracy	0 - 20mA / 4 - 20mA $R_{load} \leq 500\Omega$ $\leq 0.5\%$

Controller

Controller type	2-state controller, 3-state controller, modulating controller, continuous controller
Controller structures	P/PI/PD/PID
A/D converter	16-bit resolution
Sampling time	250ms

Timer

Accuracy	$\pm 0.8\% \pm 25\text{ppm/K}$
----------	--------------------------------

Electrical data

Supply voltage (switch-mode PSU)	110 - 240V AC -15/+10%, 48 - 63Hz 20 - 30V AC/DC, 48 - 63Hz
Electrical safety	to EN 61010, Part 1 overvoltage category III, pollution degree 2
Power consumption	max. 13VA
Data backup	EEPROM
Electrical connection	at the rear via screw terminals (pluggable terminal strips), conductor cross-section up to 2.5mm ² (type 702071: up to 1.3 mm ²); see mounting information on Page 5
Electromagnetic compatibility interference emission interference immunity	EN 61326-1 Class A - only for industrial use - to industrial requirements

Interface

Interface type	RS485
Protocol	Modbus
Baud rate	9600, 19200, 38400
Device address	0...255
Max. number of nodes	32

Housing

Housing type	plastic housing for panel mounting to IEC 61554
Depth behind panel	
Type 702071	90.5mm
Type 702072	67.0mm
Type 702074	70.0mm
Ambient/storage temperature range	-5 to +55°C / -40 to +70°C
Climatic conditions	rel. humidity < 90% annual mean, no condensation
Operating position	any
Enclosure protection	to EN 60529, at front IP 65, at rear IP 20
Weight (fully fitted)	
Type 702071	approx. 123 g
Type 702072	approx. 173 g
Type 702074	approx. 252 g

Approvals/marks of conformity

Mark of conformity	Testing laboratory	Certificates/certification numbers	Test basis	valid for
c UL us	Underwriters Laboratories	E201387-A2-UL-1	UL 61010-1 CAN/CSA-C22.2 No. 61010-1	all types

Connection diagram, type 702071 (48mm x 48mm)

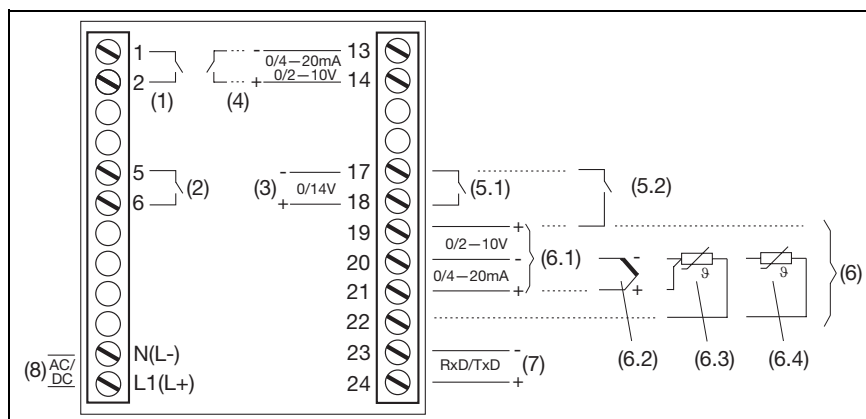

- (1) Output 1 (K1): Relay 230V AC / 3A
- (2) Output 2 (K2): Relay 230V AC / 3A
- (3) Output 3 (K3): Logic 0/14V
(at type 702071 as an alternative to binary input1, configurable)
- (4) Output 4 (K4), optional:
Analog output (0/4 - 20mA or 0/2 - 10V) or relay 230V AC / 3A
- (5.1) Binary input 1 (for floating contact)
(at type 702071 as an alternative to output 3, configurable)
- (5.2) Binary input 2 (for floating contact)
(alternative to input 0/2 - 10V, configurable with setup program)
- (6) Analog input
- (6.1) Standard signals
(0/4 - 20mA or 0/2 - 10V)
(input 0/2 - 10V alternative to binary input 2)
- (6.2) Thermocouple
- (6.3) RTD temperature probe (3-wire)
- (6.4) RTD temperature probe (2-wire)
- (7) RS485 interface (option)
- (8) Power supply
110-240V AC (option: 20-30V AC/DC)

Connection diagram, type 702072 and type 702074

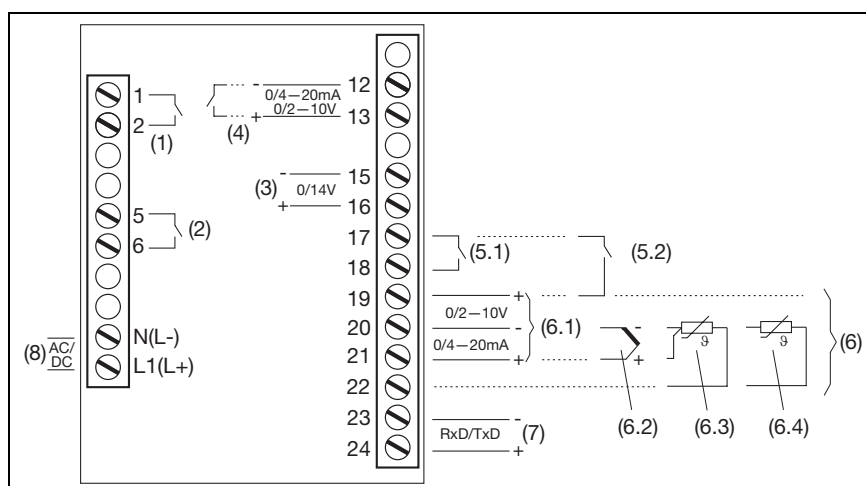

Mounting information for conductor cross-sections

	Type 702071	Type 702072 Type 702074
single-core	≤ 1.3mm ²	≤ 2.5mm ²
finely stranded, with core ferrules	≤ 1.0mm ²	≤ 1.5mm ²

Dimensions

Type 702071

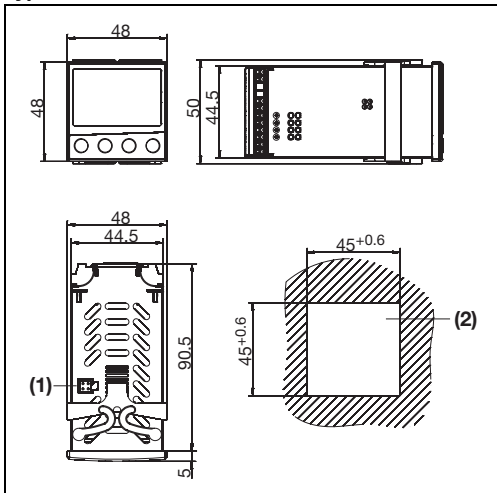

Close mounting		
Minimum spacing of panel cutouts		
Type	horizontal	vertical
without setup connector:		
702071	> 8mm	> 8mm
702072	> 10mm	> 10mm
702074	> 10mm	> 10mm
with setup connector:		
702071	> 8mm	> 65mm
702072	> 10mm	> 10mm
702074	> 10mm	> 10mm

Type 702072

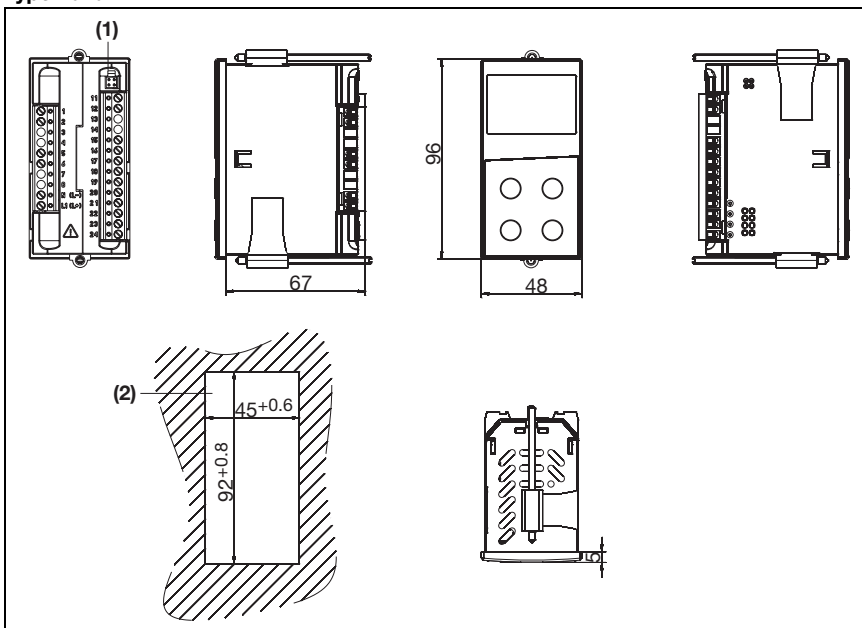

Type 702074

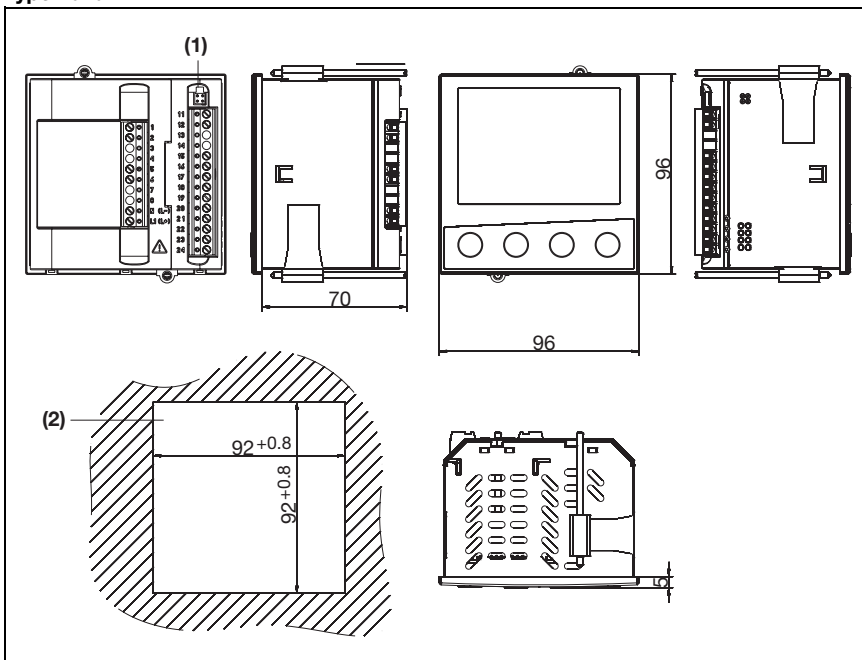

Type description

Basic type

702071	Type 702071 (nominal size 48mm x 48mm) 1 analog input, 2 binary inputs (alternative to logic output and input 0/2...10V, resp.)
702072	Type 702072 (nominal size 48mm x 96mm) 1 analog input, 2 binary inputs (one binary input alternative to input 0/2...10V)
702074	Type 702074 (nominal size 96mm x 96mm) 1 analog input, 2 binary inputs (one binary input alternative to input 0/2...10V)

Basic type extensions

8	Standard, with factory settings
9	Programming to customer specification

Outputs 1 - 2 - 3 - 4

1130	Relay - relay - logic 0/14V
1131	Relay - relay - logic 0/14V - relay
1134	Relay - relay - logic 0/14V - analog output

Supply

23	110 - 240V AC, 48 - 63Hz
25	20 - 30V AC/DC, 48 - 63Hz

Interface

00	without
53	RS485 interface with electrical isolation

/
 -
 -
 -
 Type coding
702071 / 8 - 1130 - 23 - 00 Example

Scope of delivery: - controller
 - seal
 - mounting brackets
 - operating manual B70.2070.0 in DIN A6 format

A CD with demo setup software and PDF documents (operating manual and other documentation) can be ordered separately. Individual documents and programs can be downloaded at www.jumo.net (a charge is made for enabling the software).