

# RL70 INDUSTRIAL TUBE LIGHT

## WATERPROOF INDUSTRIAL TUBE

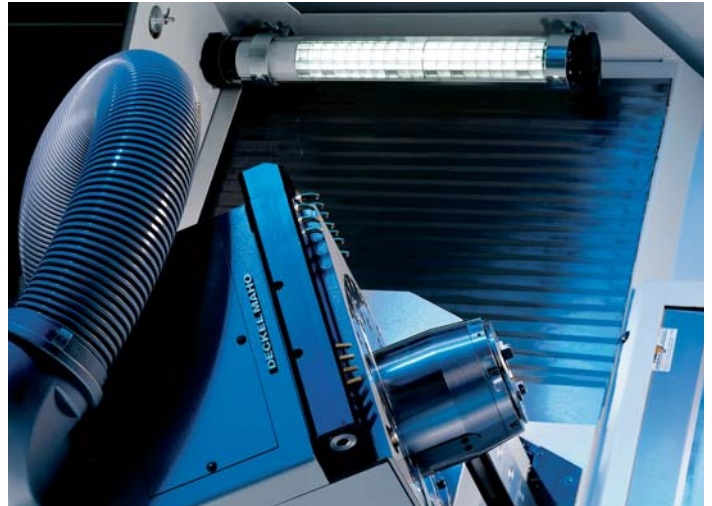

### PRODUCT DESCRIPTION:

The RL70 industrial tube light provides broad, wide area illumination inside the machine compartment and is ideal for areas requiring a high output, linear fluorescent light source. This durable, waterproof (IP67) luminaire is available in varying lengths, with a variety of mounting options to fit a wide range of applications. Available with either glass or acrylic tubes, the RL70 is designed to illuminate hard to reach areas too small for traditional luminaire mounting. It is designed to be impervi-

ous to debris, coolants and lubricants found inside the machine compartment. The RL70 is a robust luminaire designed for illuminating production and machining areas that are subject to these difficult environmental conditions. With a wide range of sizes, variants and mounting accessories, RL70 installs easily in a variety of equipment, machine compartments and enclosures. Our "All-In-One" models come pre-wired with electronic ballasts and 8ft cord sets for plug-in 120V functionality. "H" models include new, smaller, electronic "piggyback" ballasts that are located behind the lamps.

With a 2.75 inch (O.D.) tube available in glass or acrylic, RL70 models are available in lengths from 17" to 67" and provide powerful, glare-free illumination. Low-voltage models are also available in 24V DC for improved safety and connection to an existing 24V power supply on the machine. RL70 provides powerful, glare-free illumination, with controlled, even light distribution to the machining area, insuring increased safety in operating the machine tool. Acrylic tube versions can also be used for production areas, minimizing the potential for damage due to incidental contact with the luminaire.

## PRODUCT INFORMATION

Voltage:	24V DC, 24V AC, 50/60Hz, or 120-277V, 50/60Hz
Lamping:	From 17W T8 to 54W T5HO
Operation:	No integral switch, connect to external switch
Protection Rating:	IP67
Tube Material:	Acrylic or glass

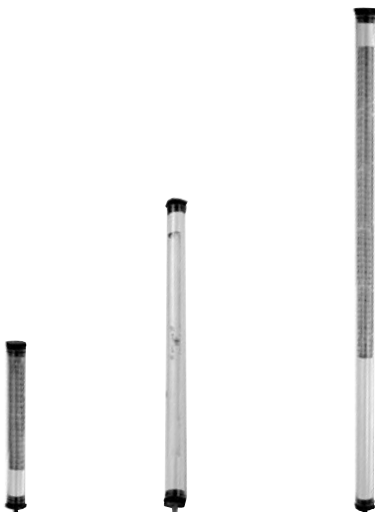

RL70 C SERIES

RL70 S SERIES

RL70 E SERIES

RL70 C Series - For CFL lamps, available w/ magnetic (CV) or electronic ballast (CE)

RL70 E Series - For standard bi-pin T5, T5HO and T8 lamps, electronic ballast only

RL70 S Series - For remote ballast applications, ballast not included

"All-In-One" models are pre-wired with electronic ballast, 8ft cord set and brackets

"H" models include piggyback, low-profile electronic ballasts, louver and end caps

**RL70 C Series** (For CFL lamps)

MODEL	PART #	VOLTAGE	TUBETYPE	LENGTH inches (mm)	LAMPING	LOUVER	REPLACEMENTTUBE
RL70CV-118	108 500 000	120V, 60Hz	Acrylic	17.6in (447mm)	1 x 18W T5 CFL	US0 300 030	305 169 060
RL70CV-118	108 500 001	120V, 60Hz	Glass	17.6in (447mm)	1 x 18W T5 CFL	US0 300 030	305 226 020
RL70CV-118*	108 500 M00	120V, 60Hz	Acrylic	17.6in (447mm)	1 x 18W T5 CFL	US0 300 030	305 169 060
RL70CV-118*	108 500 M01	120V, 60Hz	Glass	17.6in (447mm)	1 x 18W T5 CFL	US0 300 030	305 226 020
RL70CE-118	041 803 016	100-120V, 60Hz	Acrylic	18.9in (480mm)	1 x 18W T5 CFL	US0 300 010	305 169 330
RL70CE-118	041 803 015	100-120V, 60Hz	Glass	18.9in (480mm)	1 x 18W T5 CFL	US0 300 010	305 226 280
RL70CE-118	112 370 000	24V DC	Acrylic	20.6in (524mm)	1 x 18W T5 CFL	US0 300 180	305 169 910
RL70CE-118	112 370 001	24V DC	Glass	20.6in (524mm)	1 x 18W T5 CFL	US0 300 180	305 226 720
RL70CE-118	112 369 000	24V AC, 50/60Hz	Acrylic	20.6in (524mm)	1 x 18W T5 CFL	US0 300 180	305 169 910
RL70CE-118	112 369 001	24V AC, 50/60Hz	Glass	20.6in (524mm)	1 x 18W T5 CFL	US0 300 180	305 226 720
RL70CV-124	108 510 000	120V, 60Hz	Acrylic	23.6in (600mm)	1 x 24W T5 CFL	US0 300 020	305 169 020
RL70CV-124	108 510 001	120V, 60Hz	Glass	23.6in (600mm)	1 x 24W T5 CFL	US0 300 020	305 226 060
RL70CE-124	108 670 000	120-277V, 50/60Hz	Acrylic	26.7in (679mm)	1 x 24W T5 CFL	US0 300 050	305 169 450
RL70CE-124	108 670 001	120-277V, 50/60Hz	Glass	26.7in (679mm)	1 x 24W T5 CFL	US0 300 050	305 226 660
RL70CE-124*	108 670 M00	120V, 60Hz	Acrylic	26.7in (679mm)	1 x 24W T5 CFL	US0 300 050	305 169 450
RL70CE-124*	108 670 M01	120V, 60Hz	Glass	26.7in (679mm)	1 x 24W T5 CFL	US0 300 050	305 226 660
RL70CE-124H**	112 484 010	100-277V, 50/60Hz	Acrylic	19.5in (495mm)	1 x 24W T5 CFL	Included	325 713 110
RL70CE-124H**	112 484 011	100-277V, 50/60Hz	Glass	19.5in (495mm)	1 x 24W T5 CFL	Included	335 035 040
RL70CE-124	111 440 000	24V DC	Acrylic	25.2in (639mm)	1 x 24W T5 CFL	US0 300 050	305 169 020
RL70CE-124	111 440 001	24V DC	Glass	25.2in (639mm)	1 x 24W T5 CFL	US0 300 050	305 226 060
RL70CE-124	111 410 000	24V AC, 50/60Hz	Acrylic	25.2in (639mm)	1 x 24W T5 CFL	US0 300 050	305 169 020
RL70CE-124	111 410 001	24V AC, 50/60Hz	Glass	25.2in (639mm)	1 x 24W T5 CFL	US0 300 050	305 226 060
RL70CE-136	108 680 000	120-277V, 50/60Hz	Acrylic	31in (788mm)	1 x 36W T5 CFL	US0 300 060	305 169 500
RL70CE-136	108 680 001	120-277V, 50/60Hz	Glass	31in (788mm)	1 x 36W T5 CFL	US0 300 060	305 226 380
RL70CE-136*	108 680 M00	120-277V, 50/60Hz	Acrylic	31in (788mm)	1 x 36W T5 CFL	US0 300 060	305 169 500
RL70CE-136*	108 680 M01	120-277V, 50/60Hz	Glass	31in (788mm)	1 x 36W T5 CFL	US0 300 060	305 226 380
RL70CE-136H**	619 063 010	110-230V, 50/60Hz	Acrylic	21.5in (546mm)	1 x 36W T5 CFL	Included	325 713 120
RL70CE-136H**	619 063 011	110-230V, 50/60Hz	Glass	21.5in (546mm)	1 x 36W T5 CFL	Included	335 035 010
RL70CE-136	111 450 000	24V DC	Acrylic	29.4in (747mm)	1 x 36W T5 CFL	US0 300 190	305 169 130
RL70CE-136	111 450 001	24V DC	Glass	29.4in (747mm)	1 x 36W T5 CFL	US0 300 190	305 226 140
RL70CE-136	111 420 000	24V AC, 50/60Hz	Acrylic	29.4in (747mm)	1 x 36W T5 CFL	US0 300 190	305 169 130
RL70CE-136	111 420 001	24V AC, 50/60Hz	Glass	29.4in (747mm)	1 x 36W T5 CFL	US0 300 190	305 226 140

\* All-In-One model, includes brackets and 8ft cord  
 \*\* Piggyback ballast (ballast located behind lamps), w/ louver

CV = Magnetic Ballast, CE= Electronic Ballast

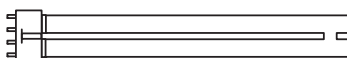

CFL (PL, BIAX) LAMP

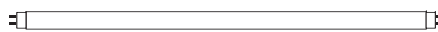

T5 AND T5HO FLUORESCENT

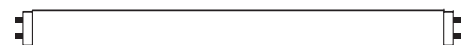

T8 FLUORESCENT

**RL70 E Series** (For standard bi-pin T5 & T8 lamps)

MODEL	PART #	VOLTAGE	TUBE TYPE	LENGTH inches (mm)	LAMPING	LOUVER	REPLACEMENT TUBE
RL70E-118	111 690 000	24V DC	Acrylic	36.2in (919mm)	1 x F18T8	US0 300 160	305 169 180
RL70E-118	111 690 001	24V DC	Glass	36.2in (919mm)	1 x F18T8	US0 300 160	305 226 270
RL70E-118	111 650 000	24V AC, 50/60Hz	Acrylic	36.2in (919mm)	1 x F18T8	US0 300 160	305 169 180
RL70E-118	111 650 001	24V AC, 50/60Hz	Glass	36.2in (919mm)	1 x F18T8	US0 300 160	305 226 270
RL70E-117	128 100 000	120-277V, 50/60Hz	Acrylic	40.6in (1030mm)	1 x F17T8	US0 300 160	305 169 600
RL70E-117	128 100 001	120-277V, 50/60Hz	Glass	40.6in (1030mm)	1 x F17T8	US0 300 160	305 226 490
RL70E-117*	128 100 900	120V, 60Hz	Acrylic	40.6in (1030mm)	1 x F17T8	US0 300 160	305 169 600
RL70E-117*	128 100 901	120V, 60Hz	Glass	40.6in (1030mm)	1 x F17T8	US0 300 160	305 226 490
RL70E-224	138 451 000	120-277V, 50/60Hz	Acrylic	41.2in (1047mm)	2 x 24W T5HO	US0 300 120	305 169 860
RL70E-224	138 451 001	120-277V, 50/60Hz	Glass	41.2in (1047mm)	2 x 24W T5HO	US0 300 120	305 226 680
RL70E-125	128 110 000	120-277V, 50/60Hz	Acrylic	52.6in (1335mm)	1 x F25T8	US0 300 080	305 169 860
RL70E-125	128 110 001	120-277V, 50/60Hz	Glass	52.6in (1335mm)	1 x F25T8	US0 300 080	305 226 500
RL70E-125*	128 110 900	120V, 60Hz	Acrylic	52.6in (1335mm)	1 x F25T8	US0 300 080	305 169 700
RL70E-125*	128 110 901	120V, 60Hz	Glass	52.6in (1335mm)	1 x F25T8	US0 300 080	305 226 500
RL70E-136	111 730 000	24V DC	Acrylic	60.3in (1532mm)	1 x F36T8	US0 300 000	305 169 400
RL70E-136	111 730 001	24V DC	Glass	60.3in (1532mm)	1 x F36T8	US0 300 000	305 226 330
RL70E-136	111 720 000	24V AC, 50/60Hz	Acrylic	60.3in (1532mm)	1 x F36T8	US0 300 000	305 169 400
RL70E-136	111 720 001	24V AC, 50/60Hz	Glass	60.3in (1532mm)	1 x F36T8	US0 300 000	305 226 330
RL70E-239	138 450 000	120-277V, 50/60Hz	Acrylic	52.7in (1338mm)	2 x 39W T5HO	US0 300 110	305 169 780
RL70E-239	138 450 001	120-277V, 50/60Hz	Glass	52.7in (1338mm)	2 x 39W T5HO	US0 300 110	305 226 340
RL70E-132	128 120 000	120-277V, 50/60Hz	Acrylic	65.2in (1656mm)	1 x F32T8	US0 300 090	305 169 520
RL70E-132	128 120 001	120-277V, 50/60Hz	Glass	65.2in (1656mm)	1 x F32T8	US0 300 090	305 226 510
RL70E-132*	128 120 900	120V, 60Hz	Acrylic	65.2in (1656mm)	1 x F32T8	US0 300 090	305 169 520
RL70E-132*	128 120 901	120V, 60Hz	Glass	65.2in (1656mm)	1 x F32T8	US0 300 090	305 226 510
RL70E-254	138 449 001	120V, 50/60Hz	Glass	67.4in (1711mm)	2 x 54W T5HO	US0 300 100	305 226 670

\* All-In-One model, includes brackets and 8ft cord

**RL70 S Series** (For use w/ remote ballast, to be purchased separately)

MODEL	PART #	TUBE TYPE	LENGTH inches (mm)	LAMPING	LOUVER	REPLACEMENT TUBE
RL70C-118 S	108 210 000	Acrylic	14.4in (367mm)	1 x 18W T5 CFL	US0 300 010	305 169 070
RL70C-118 S	108 210 001	Glass	14.4in (367mm)	1 x 18W T5 CFL	US0 300 010	305 226 010
RL70C-124 S	108 470 000	Acrylic	17.6in (447mm)	1 x 24W T5 CFL	US0 300 020	305 169 060
RL70C-124 S	108 470 001	Glass	17.6in (447mm)	1 x 24W T5 CFL	US0 300 020	305 226 020
RL70C-136 S	108 620 000	Acrylic	20.7in (525mm)	1 x 36W T5 CFL	US0 300 040	305 169 010
RL70C-136 S	108 620 001	Glass	20.7in (525mm)	1 x 36W T5 CFL	US0 300 040	305 226 050
RL70-117 S	128 130 000	Acrylic	30.9in (784mm)	1 x F17T8	US0 300 160	305 169 030
RL70-117 S	128 130 001	Glass	30.9in (784mm)	1 x F17T8	US0 300 160	305 226 040
RL70-239 S	138 453 000	Acrylic	41.6in (1057mm)	2 x 39W T5HO	US0 300 140	305 169 710
RL70-239 S	138 453 001	Glass	41.6in (1057mm)	2 x 39W T5HO	US0 300 140	305 226 520
RL70-125 S	128 140 000	Acrylic	42.9in (1089mm)	1 x F25T8	US0 300 170	305 169 710
RL70-125 S	128 140 001	Glass	42.9in (1089mm)	1 x F25T8	US0 300 170	305 226 520
RL70-132 S	128 150 000	Acrylic	54.9in (1394mm)	1 x F32T8	US0 300 130	305 169 040
RL70-132 S	128 150 001	Glass	54.9in (1394mm)	1 x F32T8	US0 300 130	305 226 030

**MOUNTING ACCESSORIES**

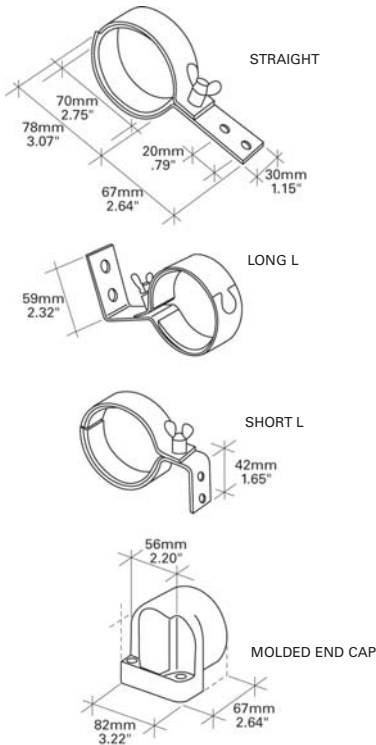

DESCRIPTION	UOM	PART #
Bracket, Straight, galvanized steel, neoprene inserts	Each	190 015 019
Bracket, Long L, galvanized steel, neoprene inserts	Each	190 015 021
Bracket, Short L, galvanized steel, neoprene inserts	Each	190 015 995
Bracket, Straight, galvanized steel, profiled rubber inserts	Each	190 015 719
Bracket, Long L, galvanized steel, profiled rubber inserts	Each	SK1 021 719
Bracket, Short L, galvanized steel, profiled rubber inserts	Each	SK0 995 719
Bracket, Straight, stainless steel, neoprene inserts	Each	190 180 019
Bracket, Long L, stainless steel, neoprene inserts	Each	190 183 019
Bracket, Short L, stainless steel, neoprene inserts	Each	190 181 019
Bracket, Straight, stainless steel, profiled rubber inserts	Each	190 180 719
Bracket, Long L, stainless steel, profiled rubber inserts	Each	190 169 719
Bracket, Short L, stainless steel, profiled rubber inserts	Each	190 181 719
Molded, plastic end cap, black	Pair*	US0 165 012

\*All RL models require 2 mounting brackets per fixture unless otherwise noted

**REMOTE BALLASTS FOR S SERIES**

BALLAST DESCRIPTION	PART #
Remote Ballast for T5 Lamps, 1 x 24/39W or 2 x 24/39W, 120-277V, 50/60Hz	309 361 050
Remote Ballast for CFL Lamps, 1 x 18/24/36W or 2 x 18/24/36W, 120-277V, 50/60Hz	309 361 030
Remote Ballast for T8 Lamps, 1 x 17/25/32W, 120-277V, 50/60Hz	309 368 010

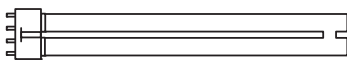

CFL (PL, BIAX) LAMP



T5 AND T5HO FLUORESCENT



T8 FLUORESCENT

**RL70 REPLACEMENT LAMPS**

WATTS	LAMP TYPE	COLOR TEMP	LAMP BASE	LENGTH inches(mm)	AVG. LUMENS	PART #
17	F17T8	4100K	G13	24in (609mm)	1400	450 017 020
18	T5 CFL	4100K	2G11	9in (229mm)	1250	450 018 010
24	T5 CFL	4100K	2G11	22in (559mm)	2000	450 024 M10
25	F25T8	4100K	G13	36in (914mm)	2225	450 025 020
32	F32T8	4100K	G13	48in (1219mm)	2950	450 032 020
36	T5 CFL	4100K	2G11	16.5in (419mm)	2900	450 036 M10
24	T5HO	4100K	G5	22.2in (563mm)	2000	450 024 M12
39	T5HO	4100K	G5	34in (864mm)	3500	450 039 012
54	T5HO	4100K	G5	46in (1168mm)	5000	450 054 012