

FLUKE®

1630

Earth Ground Clamp

Users Manual

PN 2729710
October 2006

© 2006 Fluke Corporation, All rights reserved. Printed in China
All product names are trademarks of their respective companies.

LIMITED WARRANTY AND LIMITATION OF LIABILITY

Each Fluke product is warranted to be free from defects in material and workmanship under normal use and service. The warranty period is one year and begins on the date of shipment. Parts, product repairs, and services are warranted for 90 days. This warranty extends only to the original buyer or end-user customer of a Fluke authorized reseller, and does not apply to fuses, disposable batteries, or to any product which, in Fluke's opinion, has been misused, altered, neglected, contaminated, or damaged by accident or abnormal conditions of operation or handling. Fluke warrants that software will operate substantially in accordance with its functional specifications for 90 days and that it has been properly recorded on non-defective media. Fluke does not warrant that software will be error free or operate without interruption.

Fluke authorized resellers shall extend this warranty on new and unused products to end-user customers only but have no authority to extend a greater or different warranty on behalf of Fluke. Warranty support is available only if product is purchased through a Fluke authorized sales outlet or Buyer has paid the applicable international price. Fluke reserves the right to invoice Buyer for importation costs of repair/replacement parts when product purchased in one country is submitted for repair in another country.

Fluke's warranty obligation is limited, at Fluke's option, to refund of the purchase price, free of charge repair, or replacement of a defective product which is returned to a Fluke authorized service center within the warranty period.

To obtain warranty service, contact your nearest Fluke authorized service center to obtain return authorization information, then send the product to that service center, with a description of the difficulty, postage and insurance prepaid (FOB Destination). Fluke assumes no risk for damage in transit. Following warranty repair, the product will be returned to Buyer, transportation prepaid (FOB Destination). If Fluke determines that failure was caused by neglect, misuse, contamination, alteration, accident, or abnormal condition of operation or handling, including overvoltage failures caused by use outside the product's specified rating, or normal wear and tear of mechanical components, Fluke will provide an estimate of repair costs and obtain authorization before commencing the work. Following repair, the product will be returned to the Buyer transportation prepaid and the Buyer will be billed for the repair and return transportation charges (FOB Shipping Point).

THIS WARRANTY IS BUYER'S SOLE AND EXCLUSIVE REMEDY AND IS IN LIEU OF ALL OTHER WARRANTIES, EXPRESS OR IMPLIED, INCLUDING BUT NOT LIMITED TO ANY IMPLIED WARRANTY OF MERCHANTABILITY OR FITNESS FOR A PARTICULAR PURPOSE. FLUKE SHALL NOT BE LIABLE FOR ANY SPECIAL, INDIRECT, INCIDENTAL, OR CONSEQUENTIAL DAMAGES OR LOSSES, INCLUDING LOSS OF DATA, ARISING FROM ANY CAUSE OR THEORY.

Since some countries or states do not allow limitation of the term of an implied warranty, or exclusion or limitation of incidental or consequential damages, the limitations and exclusions of this warranty may not apply to every buyer. If any provision of this Warranty is held invalid or unenforceable by a court or other decision-maker of competent jurisdiction, such holding will not affect the validity or enforceability of any other provision.

Fluke Corporation
P.O. Box 9090
Everett, WA 98206-9090
U.S.A.

Fluke Europe B.V.
P.O. Box 1186
5602 BD Eindhoven
The Netherlands

11/99

To register your product online, visit register.fluke.com

Table of Contents

Title	Page
Introduction	1
Standard Accessories	1
Contacting Fluke	2
Safety Information	2
Symbols	3
Getting Acquainted with the Clamp	4
Using the Clamp	6
Ground Resistance Measurements	6
Ground Leakage Current Measurement	8
Memory and Alarm Functions	9
Using the High and Low Alarms	9
Setting the Sampling Interval	10
Logging Data	11
Reading Data Stored in Memory	12
Clearing Memory	12
Canceling Auto-Power Off	12
Maintenance	12
Cleaning the Clamp	13
Replacing the Battery	13
Specifications	14
Electrical Specifications	14
General Specification	14
Ground Loop Resistance	15
Ground Leakage Current mA	15
Ground Leakage Current A	15

List of Tables

Table	Title	Page
1.	1630 Earth Ground Clamp Features.....	4
2.	Display Features	5

List of Figures

Figure	Title	Page
1.	1630 Earth Ground Clamp Features.....	4
2.	Display Features	5
3.	Ground Resistance Measurement Principles.....	7
4.	Ground Leakage Current Measurement.....	8
5.	Alarm Functions	9
6.	Setting the Sampling Interval.....	11
7.	Stored Data Display	12

1630

Earth Ground Clamp

Introduction

The Fluke 1630 Earth Ground Clamp (hereafter called the “the Clamp”) is a hand-held battery-operated clamp that measures the ground resistance of a ground rod without using auxiliary ground rods. The Clamp can be used in multi-grounded systems without disconnecting the ground under test.

The Clamp can be used in the following applications:

- Earth resistance testing of high voltage pylons, buildings, cell phone substations and RF transmitters
- Inspection of lightning protection systems

Standard Accessories

The following standard accessories are provided with the Clamp:

- 1 9-V alkaline battery (type IEC 6F22, NEDA 1604 installed)
- 1 Resistance test/check loop
- 1 *1630 Users Manual*
- 1 Carrying Case

Contacting Fluke

To contact Fluke, call one of the following telephone numbers:

USA: 1-888-44-FLUKE

Canada: 1-800-363-FLUKE

Europe: +31 402-675-200

Japan: +81-3-3434-0181

Singapore: +65-738-5655

Anywhere in the world: +1-425-446-5500

USA Service: 1-888-99-FLUKE (1-888-993-5853)

Or, visit Fluke's Web site at www.fluke.com

To register your product, visit register.fluke.com

Safety Information

⚠️⚠️ Read First: Safety Information









To ensure safe operation and service of the 1630 Earth Ground Clamp, follow these instructions:

- **Read the operating instructions before use and follow all safety instructions.**
- **Use the Clamp only as specified in the operating instructions, otherwise the Clamp's safety features may not protect you.**
- **Adhere to local and national safety codes. Individual protective equipment must be used to prevent shock and arc blast injury where hazardous live conductors are exposed.**
- **Before each use, inspect the Clamp. Look for cracks or missing portions of the Clamp housing or output cable insulation. Also look for loose or weakened components. Pay particular attention to the insulation surrounding the jaws.**
- **Never use the Clamp on a circuit with voltages higher than 600 V CAT II or 300 V CAT III.**

- **CAT II equipment is designed to protect against transients from energy-consuming equipment supplied from the fixed installation, such as TVs, PCs, portable tools, and other household appliances.**
- **CAT III equipment is designed to protect against transients in equipment in fixed-equipment installations, such as distribution panels, feeders and short branch circuits, and lighting systems in large buildings.**
- **Use extreme caution when working around bare conductors or busbars. Contact with the conductor could result in electric shock.**
- **Use caution when working with voltages above 60 V dc or 30 V ac. Such voltages pose a shock hazard.**

Symbols

The following symbols are found on the Clamp or in this manual.

	May be used on hazardous live conductors
	Risk of danger. Important information. See Users Manual.
	Hazardous voltage. Risk of electric shock.
	Double insulation
	Battery
	Conforms to relevant European Union directives
	Do not dispose of this product as unsorted municipal waste. Contact Fluke or a qualified recycler for disposal.
	Complies with Canadian and US Standards

Getting Acquainted with the Clamp

Refer to Figures 1 and 2 and Tables 1 and 2 to become more familiar with the Clamp's features.

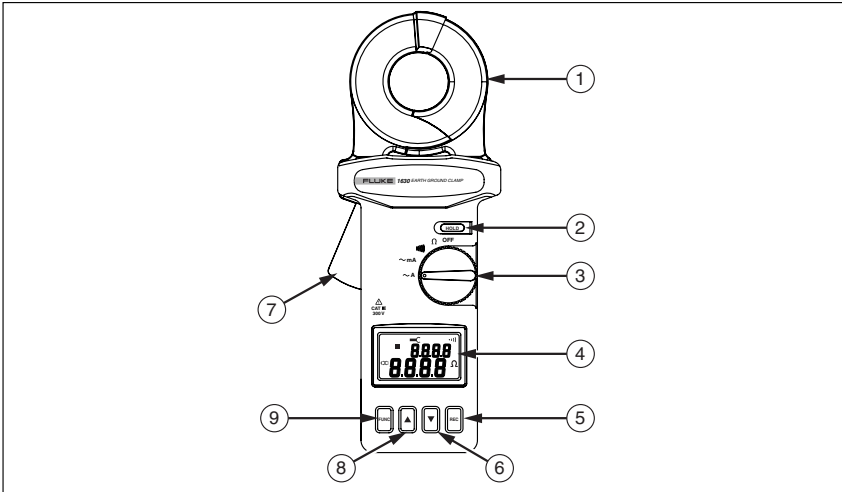

eh101f.eps

Figure 1. 1630 Earth Ground Clamp Features

Table 1. 1630 Earth Ground Clamp Features

Number	Description
①	Jaws. Used to enclose electrode or ground wire.
②	HOLD button. Press to hold the displayed value.
③	Rotary Switch for power on and function selection.
④	LCD
⑤	REC button. Press to start data logging.
⑥	Down arrow used to decrement value.
⑦	Up arrow used to increment value.
⑧	FUNC button. Press to select HI (high alarm), LO (low alarm), SEC (seconds), or stored memory locations.
⑨	Jaw release.

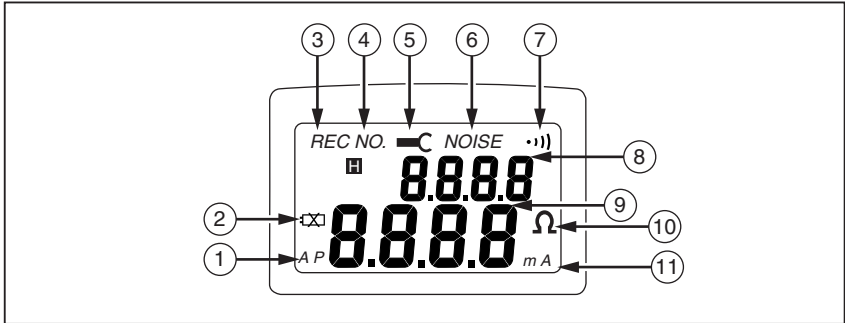

eh102f.eps

Figure 2. Display Features

Table 2. Display Features

Number	Description
①	Indicates the Clamp will Autopower off in 4 to 6 minutes.
②	Low battery indicator - the batteries are low and need to be changed. <div style="text-align: center;"> <p>⚠ ⚠ Warning</p> <p>To avoid false readings, which could lead to possible electric shock or personal injury, replace the batteries as soon as the battery indicator appears.</p> </div>
③	Indicates data logging is in progress.
④	Indicates memory location.
⑤	Indicates the jaw is not closed properly. This symbol appears on the display.
⑥	Indicates noise present in ground electrode or ground rod.
⑦	Indicates the rotary switch is in the alarm function.
⑧	Displays current selected function or current memory location.
⑨	Displays value from 0 to 9999 with decimal point.
⑩	Indicates ohms and alarm functions.
⑪	Indicates current in mA or A.

Using the Clamp

Ground Resistance Measurements

To perform ground resistance measurements:

1. Open the jaws and make sure the surfaces fit together properly and are free of dust, dirt, or any foreign substances.
2. Turn the Clamp on by moving the rotary switch to the Ω function.

Note

Do not attach the Clamp to a conductor or open the jaws now or during self-calibration or calibration will be interrupted.

3. After power is turned on, the Clamp self-calibrates for better accuracy. Wait for self-calibration to finish before making measurements. During the self-calibration, the display will show $[CAL 1]$, $[CAL 6]$, ..., $[CAL 2]$, $[CAL 1]$. The Clamp beeps when self-calibration is completed.
4. Attach the Clamp to the electrode or ground rod to be measured.
5. Read the value of R_g (ground resistance) from the display. Figure 3 illustrates the ground resistance measurement principles.

Note

- *If self-calibration does not stop, check the jaw surfaces for dust or dirt and power up the Clamp again.*
- *If there is more than 3 A or 30 V in the ground rod, the jaw icon and the word **NOISE** flash on the display and the Clamp beeps. When noise is present the Clamp reading is not valid.*
- *If the jaw assembly is opened during measurement, the jaw icon appears on the display.*

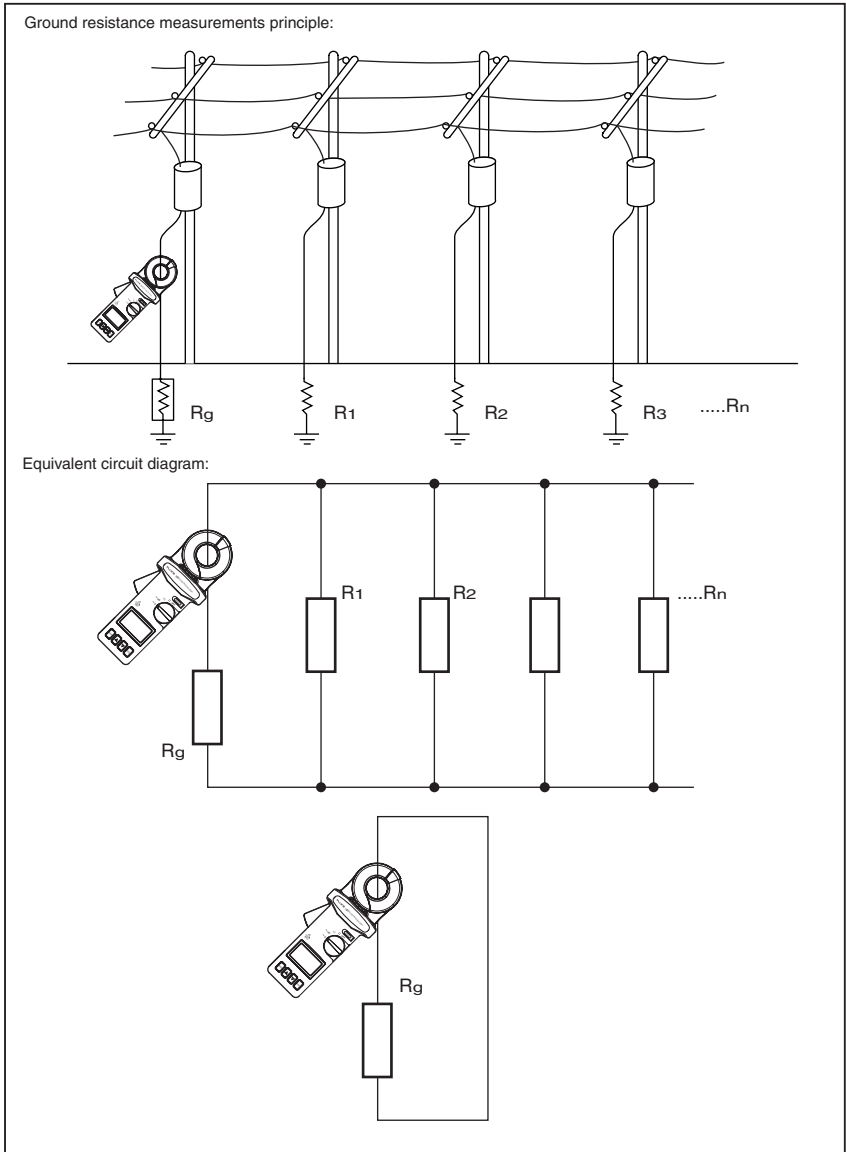

eh103f.eps

Figure 3. Ground Resistance Measurement Principles

Ground Leakage Current Measurement

To perform a ground leakage current measurement test:

1. Open the jaws and make sure the surfaces fit together properly and are free of dust, dirt, or any foreign substances.
2. Turn the Clamp on by moving the rotary switch to the \sim mA or \sim A function.
3. Attach the Clamp to the electrode or ground rod to be measured. Figure 4 shows a connection for a ground leakage current measurement.
4. Read the value of the leakage current on the display.

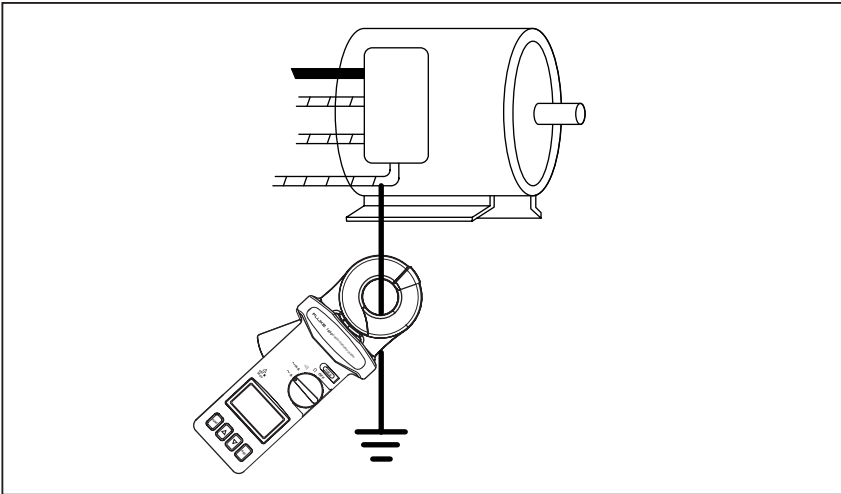





eht05f.eps

Figure 4. Ground Leakage Current Measurement

Memory and Alarm Functions

Using the High and Low Alarms

1. Press  to select the HI or LO alarm, although this describes the ohms function high and low alarms can be set in any of the other functions. The current value of High or Low alarm will appear on the display. Figure 5 shows alarm function displays.
2. Press the  or  button to increment/decrement the value by 1 Ω . The value can be incremented or decremented from 0 Ω to 1510 Ω and then OL. Hold down the up or down buttons to quickly increment/decrement to the desired value.
3. When the value is set, press  until you return to the main display.
4. When the rotary switch is set to the  position, the Clamp compares the current value with the high and low values. If the current measurement is larger than the HI value, the Clamp beeps and shows HI-- in the upper display. If the measurement is less than the LO value, the Clamp will beep and LO-- appears in the upper display.

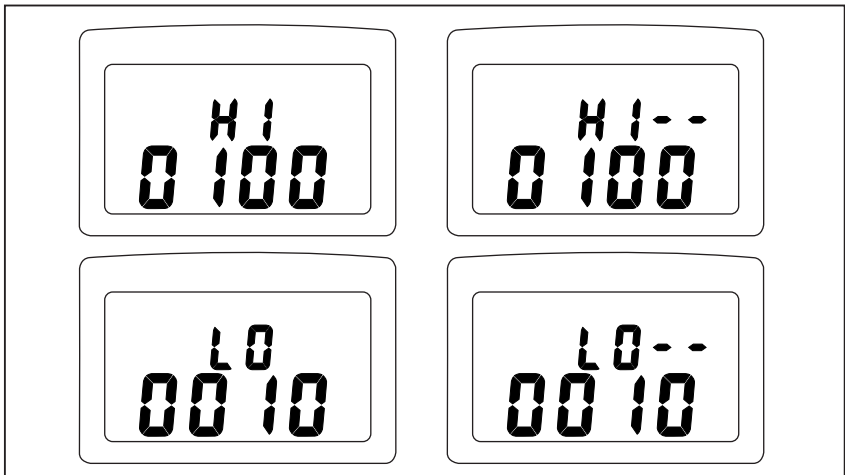





Figure 5. Alarm Functions

eh106.eps

Note

- *If the HI value is set at OL, or the LO value is set at 0, the ALARM function will be disabled.*
- *The HI value can't be smaller than the LO value and the LO value can't be larger than the HI value. HI value will be adjusted to the LO value when a rollover occurs. The maximum LO value is the HI value.*
- *If data logging is progressing, the beeper is disabled to save battery power but the display will still show the warning letters HI-- or LO--.*
- *The values of the high and low alarm are stored in memory. They are restored when the Clamp is turned on.*

Setting the Sampling Interval

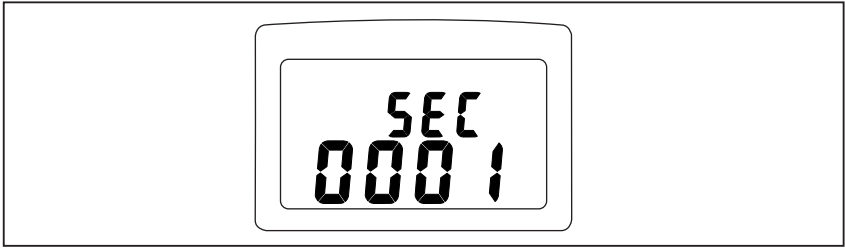

1. Press the FUNC button until **SEC** appears in the upper display. Figure 6 shows the sampling interval display.
2. The Clamp shows the current sampling interval in seconds.
3. Press  or  to increment/decrement the sampling interval by 1 second. The sampling interval can be incremented or decremented from 0 to 255 seconds. Hold down the up or down buttons to quickly increment/decrement to the desired value.
4. Press  until you return to the main display.



eh107f.eps

Figure 6. Setting the Sampling Interval



Logging Data

1. Press ; REC appears in the upper display.
2. Data is recorded at the sampling interval you specified. Data logging will stop when memory is full, the Clamp detects a low battery, or you press the  button again.

Note

If the sampling interval is set at 0 seconds, only one data point is recorded. To record the next data point press the REC button again. The memory location is also displayed for about 1 second.

Reading Data Stored in Memory

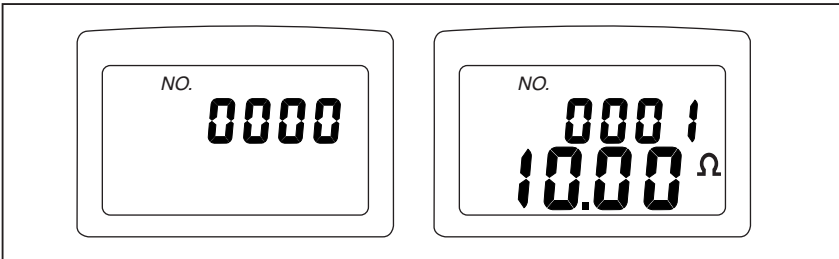

1. Press  until NO. appears on the display. The current memory location appears on the upper display and the stored data appears on the lower display. Figure 7 shows the stored data display.
2. Press  or  to go to the next or previous memory location. The memory location rolls over when the first or last record is reached.





eht08f.eps

Figure 7. Stored Data Display

Clearing Memory

To clear the memory press and hold  and then turn the Clamp on. The letters  appear on the display and indicate that memory is cleared.

Canceling Auto-Power Off

When the Clamp is turned on, the letters  appear on the display and indicate that Auto-Power Off is turned on. To cancel Auto-Power Off, press  and then turn the Clamp on. The letters  will no longer appear on the display.

Maintenance

Warning

To avoid possible electric shock or personal injury, repairs or servicing not covered in this manual should be performed only by qualified personnel.

Cleaning the Clamp

⚠ Caution

To avoid damaging the Clamp, do not use aromatic hydrocarbons or chlorinated solvents for cleaning. These solutions will react with the plastics used in the Clamp.

Clean the instrument case with a damp cloth and mild detergent.

Replacing the Battery

⚠ ⚠ Warning

To avoid false readings that could lead to possible electric shock or personal injury, replace the batteries as soon as the low battery indicator (⚡) appears.

To replace the battery:

1. Turn the rotary switch to OFF.
2. Use a Phillips screw driver to remove the bottom case screws.
3. Lift and remove the bottom case.
4. Remove the old battery.
5. Replace the battery with a new 9-V battery.
6. Install the bottom case and tighten the screws.

Specifications

Electrical Specifications

Display.....	9999 digit liquid crystal display with special symbols
Operating Humidity.....	Less than 85% RH
Storage Temperature	-20 °C to 60 °C (-4 °F to 140 °F)
Storage Humidity.....	Less than 75% RH
Reference Temperature	23 °C ± 5 °C (73 °F ±9 °F)
Temperature Coefficient.....	0.1 % X (specified accuracy)/ °C (< 18 °C or > 28 °C)
Operating Temperature	0 °C to +50 °C (+32 °F to +122 °F)
Protective Type	IP23 according to IEC 60529/EN 60529
Category Rating	300 V CAT III/pollution degree 2 and 600 V CAT II
EMC (Emission)	IEC 61000-4-1, IEC 61326-1 class B
EMC (Immunity)	IEC 61000-4-2 8 kV (air) criteria B, IEC 61000-4-3 V/m perf. Criteria A
Range Selection	Auto
Overload Indication	OL
Measurement Frequency	3.333 kHz
Power Requirement.....	9 V alkaline (type IEC 6F22, NEDA 1604)
Power Consumption	Approx. 40 mA (in Ω function)
Low Battery Indicator.....	+
Maximum Non-destructive Current.....	100 A continuous, 200 A (< 10 sec) 50/60 Hz
Accuracy of Calibration Plate	+/- 0.5%
Data Logging Capacity	116 records
Data Logging Interval	1 to 255 seconds

General Specification

Conductor Size.....	35 mm (1.38 in) approximately
Dimensions.....	276 mm (L) x 100 mm (W) X 47 mm (H) 10.8 in (L) x 3.9 in (W) x 1.9 in (H)
Weight	750 g (1.65 lbs)

Ground Loop Resistance

Range	Accuracy ^[1] (± % of reading + Ω)
0.025 to 0.250 Ω	± 1.5 % + 0.02 Ω
0.250 to 1.000 Ω	± 1.5 % + 0.002 Ω
1.000 to 9.999 Ω	± 1.5 % + 0.01 Ω
10.00 to 50.00 Ω	± 1.5 % + 0.03 Ω
50.00 to 99.99 Ω	± 1.5 % + 0.5 Ω
100.0 to 200.0 Ω	± 3.0 % + 1.0 Ω
200.1 to 400.0 Ω	± 5.0 % + 5.0 Ω
400.0 to 600.0 Ω	± 10.0 % + 10.0 Ω
600.0 to 1500.0 Ω	± 20.0 %
[1] Loop resistance with no inductance, external field < 200 A/m, external electrical field < 1 V/m, conductor centered.	

Ground Leakage Current mA

Autorange 50/60 Hz, True rms, crest factor CF <3.5

Range	Accuracy
0.300 to 1.000 mA	± 2.0 % rdg ± 0.05 mA
1.00 to 10.00 mA	± 2.0 % rdg ± 0.03 mA
10.0 to 100.0 mA	± 2.0 % rdg ± 0.3 mA
100 to 1000 mA	± 2.0 % rdg ± 3.0 mA

Ground Leakage Current A

50/60 Hz, True rms, crest factor CF <3.5

Range	Accuracy
0.200 to 4.000 A	± 2.0 % rdg ± 0.003 A
4.00 to 35.00 A	± 2.0 % rdg ± 0.03 A

