



Building Automation

Industrial Automation

Systems

User Manual

easy500, easy700 Control Relay

05/04 AWB2528-1508GB

MOELLER 

Think future. Switch to green.

All brand and product names are trademarks or registered trademarks of the owner concerned.

1st published 2004, edition date 05/04

© Moeller GmbH, 53105 Bonn

Author: Dieter Bauerfeind
Editor: Michael Kämper
Translator: Terence Osborn

All rights reserved, including those of the translation.

No part of this manual may be reproduced in any form (printed, photocopy, microfilm or any other process) or processed, duplicated or distributed by means of electronic systems without written permission of Moeller GmbH, Bonn.

Subject to alteration without notice.



Warning! Dangerous electrical voltage!

Before commencing the installation

- Disconnect the power supply of the device.
- Ensure that devices cannot be accidentally restarted.
- Verify isolation from the supply.
- Earth and short circuit.
- Cover or enclose neighbouring units that are live.
- Follow the engineering instructions (AWA) of the device concerned.
- Only suitably qualified personnel in accordance with EN 50110-1/-2 (VDE 0105 Part 100) may work on this device/system.
- Before installation and before touching the device ensure that you are free of electrostatic charge.
- The functional earth (FE) must be connected to the protective earth (PE) or to the potential equalisation. The system installer is responsible for implementing this connection.
- Connecting cables and signal lines should be installed so that inductive or capacitive interference does not impair the automation functions.
- Install automation devices and related operating elements in such a way that they are well protected against unintentional operation.
- Suitable safety hardware and software measures should be implemented for the I/O interface so that a line or wire breakage on the signal side does not result in undefined states in the automation devices.
- Ensure a reliable electrical isolation of the low voltage for the 24 volt supply. Only use power supply units complying with IEC 60364-4-41 (VDE 0100 Part 410) or HD 384.4.41 S2.
- Deviations of the mains voltage from the rated value must not exceed the tolerance limits given in the specifications, otherwise this may cause malfunction and dangerous operation.
- Emergency stop devices complying with IEC/EN 60204-1 must be effective in all operating modes of the automation devices. Unlatching the emergency-stop devices must not cause restart.
- Devices that are designed for mounting in housings or control cabinets must only be operated and controlled after they have been installed with the housing closed. Desktop or portable units must only be operated and controlled in enclosed housings.

- Measures should be taken to ensure the proper restart of programs interrupted after a voltage dip or failure. This should not cause dangerous operating states even for a short time. If necessary, emergency-stop devices should be implemented.
- Wherever faults in the automation system may cause damage to persons or property, external measures must be implemented to ensure a safe operating state in the event of a fault or malfunction (for example, by means of separate limit switches, mechanical interlocks etc.).

Content

<hr/>	
About This Manual	9
Device designation	9
Writing conventions	10
<hr/>	
1 easy	11
Target readership	11
Proper use	11
– Improper use	11
Overview	12
Versions	15
– Type reference	17
easy operation	19
– Buttons	19
– Moving through menus and choosing values	19
– Selecting main and system menu	20
– easy Status display	21
– Status display for local expansion	21
– Advanced Status display	22
– easy LED display	22
– Menu structure	23
– Selecting or toggling between menu items	28
– Cursor display	28
– Setting values	29

2	Installation	31
	Mounting	31
	Connecting the expansion device	34
	Terminals	35
	– Tools	35
	– Cable cross-sections	35
	Connecting the power supply	35
	– Cable protection	35
	– Supplying AC units	36
	– Supplying DC units	37
	Connecting the inputs	39
	– Connecting easy AC digital inputs	39
	– Connecting easy DC digital inputs	44
	– Connecting easy DC analog inputs	46
	– Connecting high-speed counters and frequency generators	51
	Connecting the outputs	53
	– Connecting relay outputs	54
	– Connecting transistor outputs	56
	Expanding inputs/outputs	59
	– Local expansion	59
	– Remote expansion	60
	Connecting bus systems	62

3	Commissioning	63
	Switching on	63
	Setting the menu language	64
	easy operating modes	65
	Creating your first circuit diagram	66
	– Circuit diagram display	68
	– From the first contact to the output coil	69
	– Wiring	70
	– Testing the circuit diagram	71
	– Deleting the circuit diagram	73
	– Fast circuit diagram entry	73

4	Wiring with easy	75
	Operation of easy	75
	– Buttons for editing circuit diagrams and function relays	75
	– Operation	76
	– Relay, function relays	79
	– Saving and loading circuit diagrams	82
	Working with contacts and relays	83
	– Input and output contacts	83
	– Creating and modifying connections	86
	– Inserting and deleting a rung	88
	– Switching with the cursor buttons	89
	– Checking the circuit diagram	90
	– Coil functions	91
	Function relays	97
	– Example with function relay timer and counter relay	98
	Analog value comparator/threshold value switch	104
	– Circuit diagram display with analog value comparator	105
	– Compatibility between easy400 and easy500, easy600 and easy700	107
	– Parameter display in RUN mode	108
	– Resolution of the analog inputs	108
	– Function of the analog value comparator	109
	Counters	117
	– Function of the counter function relay	121
	High-speed counters, easy-DA, easy-DC	125
	– Frequency counters	125
	– High-speed counter	131
	Text display	137
	– Wiring a text display	138
	– Retention	138
	– Scaling	139
	– Function	139
	– Text entry	140
	– Character set	140
	– Entering a setpoint in a display	141

7-day time switch	143
– Parameter display and parameter set for 7-day time switch:	144
– Changing time switch channel	145
– Function of the 7-day time switch	146
Operating hours counter	149
– Value range of the operating hours counter	150
– Accuracy of the operating hours counter	150
– Function of the operating hours counter function block	150
Timing relays	154
– Parameter display and parameter set for a timing relay:	155
– Retention	156
– Timing relay modes	157
– Time range	157
– Function of the timing relay function block	160
– Timing relay examples	168
Jumps	171
– Function	171
– Power flow display	172
Year time switch	174
– Wiring of a year time switch	174
– Parameter display and parameter set for the year time switch:	175
– Changing time switch channel	176
– Entry rules	176
– Function of the year time switch	178
Master reset	181
– Operating modes	182
– Function of the master reset function relay	182

Basic circuits	183
– Negation (contact)	183
– Negation (coil)	184
– Maintained contact	184
– Series circuit	184
– Parallel circuit	185
– Parallel circuit operating like a series connection of make contacts	186
– Parallel circuit operating like a series connection of break contacts	187
– Two-way circuit	187
– Self-latching	188
– Impulse relay	189
– Cycle pulse on rising edge	190
– Cycle pulse on falling edge	190
Example circuits	191
– Star-delta starting	191
– 4x shift register	193
– Running light	197
– Stairwell lighting	199
<hr/>	
5 easy Settings	203
Password protection	203
– Password setup	204
– Selecting the scope of the password	205
– Activating the password	206
– Unlocking easy	207
Changing the menu language	209
Changing parameters	210
– Adjustable parameters for function relays	211
Setting date, time and daylight saving time	213
– Setting the time	213
– Setting summer time start and end	214
– Setting summer time start and end	215
– Summer time start and end, setting the rule	215
Activating debounce (input delay)	222
– Activating debounce (input delay)	223
– Deactivating debounce (input delay)	223

Activating and deactivating the P buttons	224
– Activating the P buttons	224
– Function of the P buttons	224
– Deactivating the P buttons	225
Startup behaviour	225
– Setting the startup behaviour	225
– Behaviour when the circuit diagram is deleted	226
– Behaviour during upload/download to card or PC	227
– Possible faults	227
– Card mode behaviour	227
Setting the cycle time	229
Retention (non-volatile data storage)	230
– Permissible markers and function relays	230
– Setting retentive behaviour	230
– Deleting retentive actual values	232
– Transferring retentive behaviour	232
– Changing the operating mode or the circuit diagram	233
– Changing the startup behaviour in the SYSTEM menu	233
Displaying device information	234

6	Inside easy	235
	easy circuit diagram cycle	235
	– easy operation and effects on circuit diagram creation	236
	Delay times for inputs and outputs	238
	– Delay times with easy-DA and easy-DC basic units	238
	– Delay time with easy-easy-AB, easy-AC basic units	240
	– Delay times for the analog inputs of easy-AB, easy-DA and easy-DC	241
	Monitoring of short-circuit/overload with EASY..-D.-T..	242
	Expanding easy700	243
	– How is an expansion unit recognised?	244
	– Transfer behaviour	244
	– Function monitoring of expansion units	245
	Saving and loading circuit diagrams	246
	– EASY...-.-.X	246
	– Interface	246
	Memory card	248
	– Compatibility with EASY-M-8K, EASY-M-16K memory cards	248
	– Loading or saving circuit diagrams	249
	EASY-SOFT-BASIC	252
	Overview with stand-alone display/operating unit	253
	Device version	254
7	What Happens If ...?	255
	Messages from the easy system	255
	Possible situations when creating circuit diagrams	256
	Event	258

Appendix	259
Dimensions	259
Technical Data	262
– General	262
– Special approvals	264
– Power supply	265
– Inputs	266
– Relay outputs	272
– Transistor outputs	274
List of the function relays	277
– Usable contacts	277
– Available function relays	278
– Names of relays	279
– Names of function relay	279
– Name of function block inputs (constants, operands)	280
Compatibility of function relay parameters	281
– Parameter display of analog value comparator	281
– Parameter display of counters	281
– Parameter display of 7-day time switch	282
– Parameter display of timing relay	282

Glossary	283
-----------------	-----

Index	287
--------------	-----

About This Manual

This manual describes the installation, commissioning and programming (circuit diagram generation) of the easy500 and easy700 control relay.

Specialist electrical training is needed for commissioning and creating circuit diagrams. When active components such as motors or pressure cylinders are controlled, parts of the system can be damaged and persons put at risk if the device is connected or programmed incorrectly.

Device designation

This manual uses the following abbreviated designations for different easy models:

easy412 for all EASY412-.-.-... devices

EASY512-.-.-..., EASY7.-.-.-...

Type designation of the control relay, the dots represent placeholders for all characters used.

easy500 for

EASY512-AB..., EASY512-AC..., EASY512-DA... and
EASY512-DC...

easy600 for all EASY61.-AC-RC(X), EASY62.-DC-TC(X)

easy700 for

EASY719-AB..., EASY719-AC..., EASY719-DA..., EASY719-
DC... and EASY721-DC...

easy-AB for

EASY512-AB...
EASY719-AB...

easy-AC for

EASY512-AC...
EASY618-AC-RE and EASY719-AC...

easy-DA for

EASY512-DA...
EASY719-DA...

easy-DC for
EASY512-DC...
EASY6..-DC..., EASY719-DC... and EASY721-DC...

easy-E for
EASY2.., EASY618-AC-RE, EASY618-DC-RE and EASY620-
DC-TE

Writing conventions

Symbols used in this manual have the following meanings:

► indicates actions to be taken.



Attention!

Warns of a hazardous situation that could result in damage to the product or components.



Caution!

Warns of the possibility of serious damage and slight injury.



Warning!

Warns of the possibility of a hazardous situation that could result in major damage and serious or fatal injury or even death.



Indicates interesting tips and additional information

For greater clarity, the name of the current chapter is shown in the header of the left-hand page and the name of the current section in the header of the right-hand page. Pages at the start of a chapter and empty pages at the end of a chapter are exceptions.

1 easy

Target readership

easy must only be installed and connected up by trained electricians or other persons who are familiar with the installation of electrical equipment.

Specialist electrical training is needed for commissioning and creating circuit diagrams. When active components such as motors or pressure cylinders are controlled, parts of the system can be damaged and persons put at risk if easy is connected or programmed incorrectly.

Proper use

easy is a programmable switching and control device and is used as a replacement for relay and contactor control circuits. easy may only be operated when it has been correctly and properly installed.

- easy is designed to be installed in an enclosure, switch cabinet or service distribution board. Both the power feed and the signal terminals must be laid and covered so as to prevent accidental contact.
- The installation must comply with regulations for electromagnetic compatibility (EMC).
- The starting up of easy should not cause any hazards arising from controlled devices, such as unexpected motor startups or power ups.

Improper use

easy should not be used as a substitute for safety-related controls such as burner or crane controls, emergency-stop or two-hand safety controls.

Overview

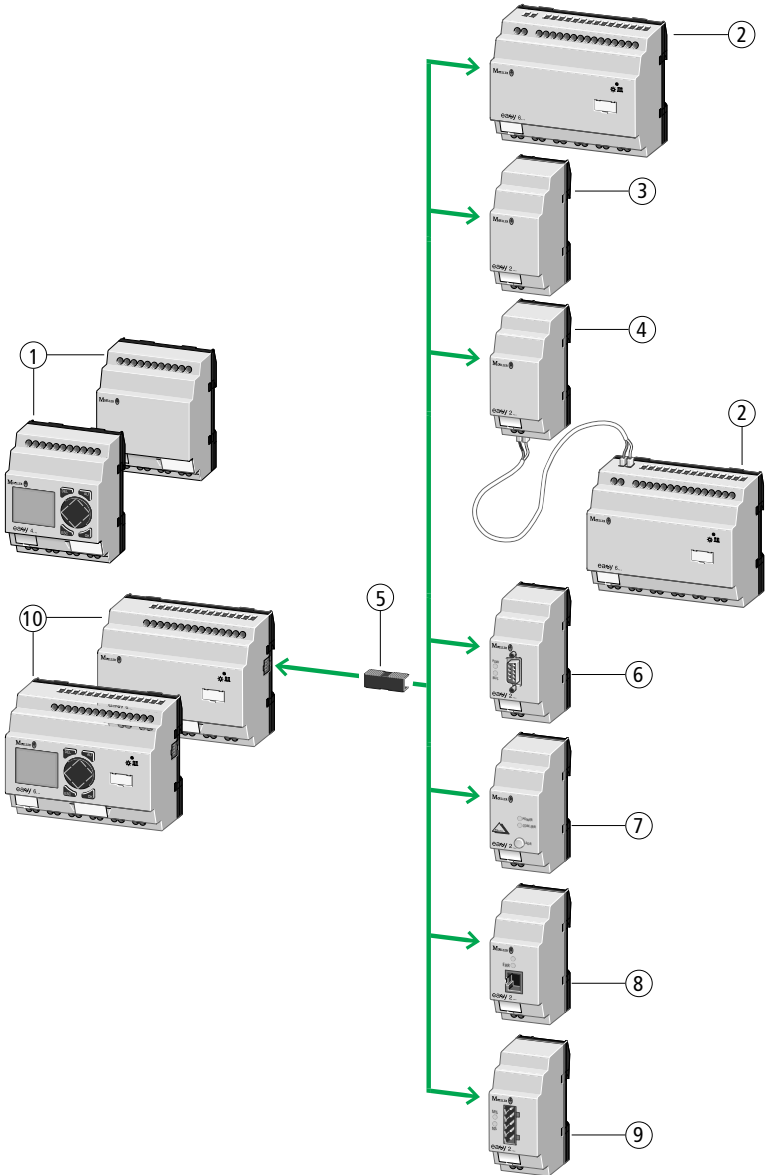

Figure 1: easy basic units and expansion devices

Legend for figure 1:

- ① easy500 basic unit
- ② easy600 I/O expansion
- ③ EASY202-RE output expansion
- ④ EASY200-EASY coupling device
- ⑤ EASY-LINK-DS data connector
- ⑥ EASY204-DP PROFIBUS-DP slave gateway
- ⑦ EASY205-ASI AS-Interface slave gateway
- ⑧ EASY221-CO CANopen gateway
- ⑨ EASY222-DN DeviceNet gateway
- ⑩ easy700 basic unit

easy is an electronic control relay with logic functions, timer, counter and time switch functions. It is also a control and input device in one that can perform many different tasks in domestic applications as well as in machine building and plant construction.

Circuit diagrams are connected up using ladder diagrams, and each element is entered directly via the easy display. For example, you can:

- Connect make and break contacts in series and in parallel
- Connect output relays and markers,
- Use outputs as relays, impulse relays or latching relays
- Use multi-function timing relays with different functions
- Use up and down counters,
- Count high-speed counter pulses
- Measure frequencies
- Process analog inputs, easy-AB, easy-DA, easy-DC, (EASY512...: two analog inputs, easy700: four analog inputs)
- Display any texts with variables, enter setpoints
- Use year time switches, 7-day time switches, EASY...-..-C(X),
- Count operating hours (four retentive operating hours counters integrated)
- Track the flow of current in the circuit diagram
- Load, save and password-protect circuit diagrams

If you prefer to wire up easy from a PC, then use EASY-SOFT-BASIC. EASY-SOFT-BASIC allows you to create and test your circuit diagram on the PC. EASY-SOFT-BASIC is also used to print out your circuit diagram in DIN, ANSI or easy format.

Versions

easy basic units at a glance

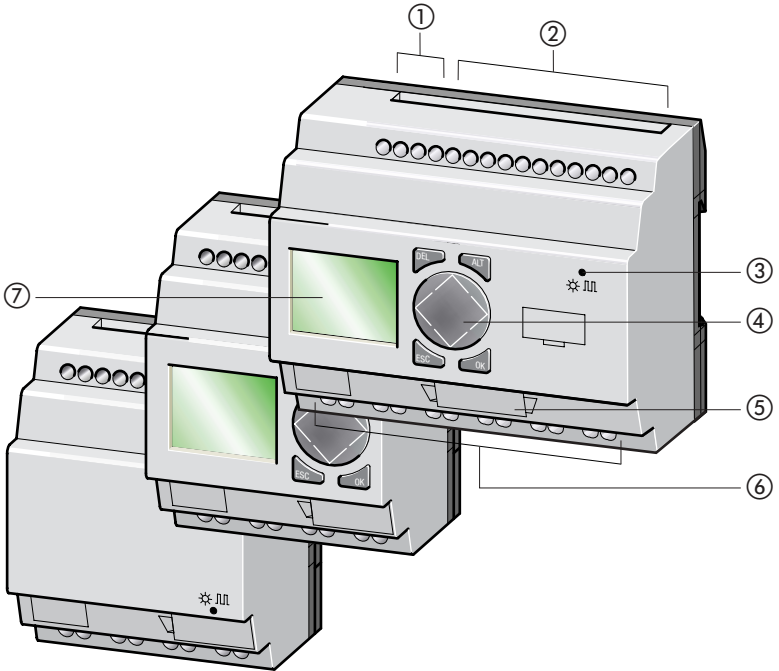

Figure 2: Versions

- ① Power supply
- ② Inputs
- ③ Status LED
- ④ Buttons
- ⑤ Interface socket for memory card or PC connection
- ⑥ Outputs
- ⑦ LCD display

easy basic units with stand-alone MFD-80.., MFD-CP4-500 HMI unit

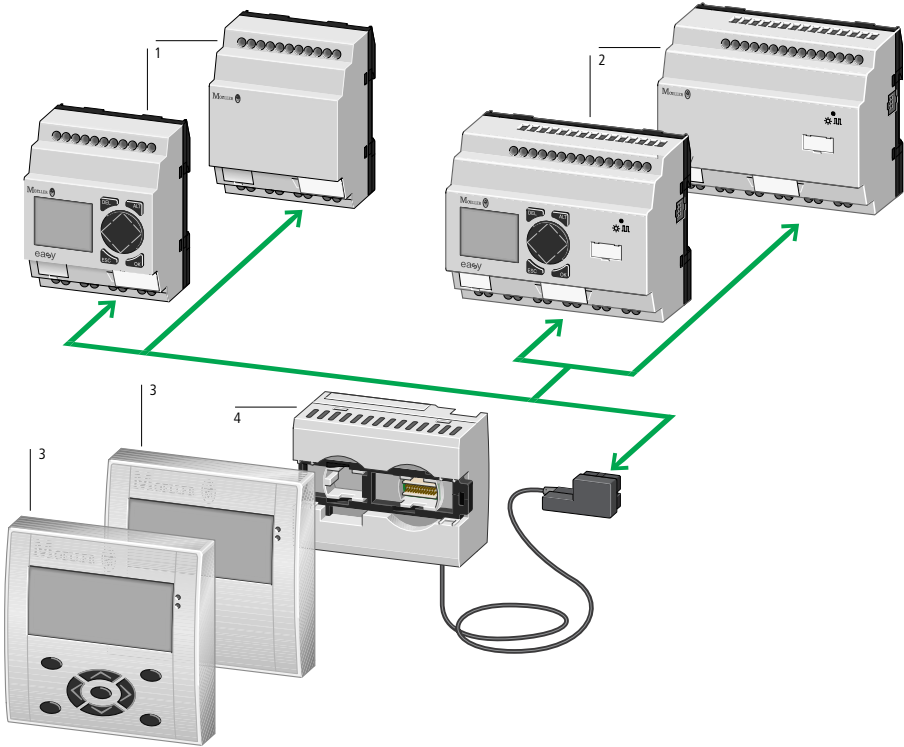

Figure 3: Overview with stand-alone HMI unit

- ① easy500 basic units
- ② easy700 basic units
- ③ MFD device
- ④ Power supply/communication module with MFD-CP4-500 interface cable

Type reference

EASY - x x x - x x - x x x x

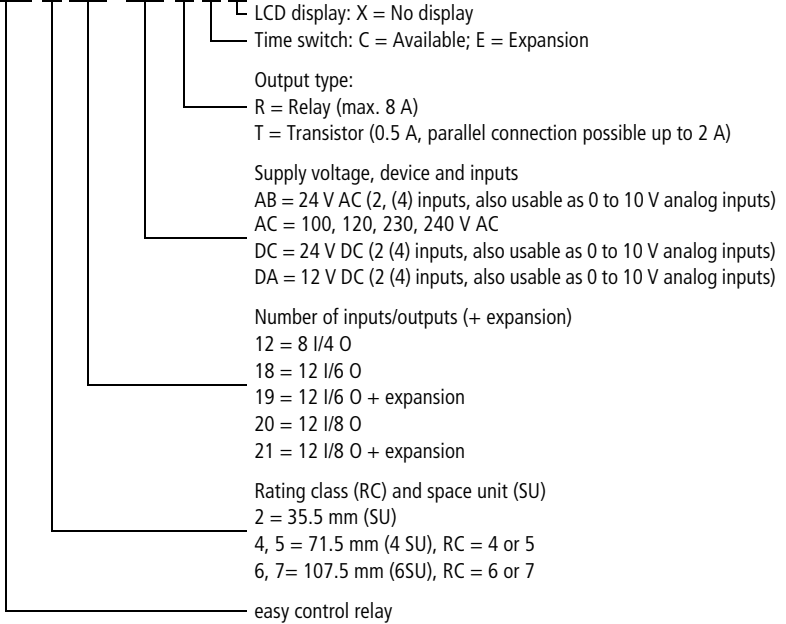

Table 1: Overview of comparable easy400 types with easy500 and easy600 with easy700

easy400, easy600	easy500, easy700
–	EASY512-AB-RC
–	EASY512-AB-RCX
EASY412-AC-R	EASY512-AC-R
EASY412-AC-RC	EASY512-AC-RC
EASY412-AC-RCX	EASY512-AC-RCX
EASY412-DA-RC	EASY512-DA-RC
EASY412-DA-RCX	EASY512-DA-RCX
EASY412-DC-R	EASY512-DC-R
EASY412-DC-RC	EASY512-DC-RC

easy400, easy600	easy500, easy700
EASY412-DC-RCX	EASY512-DC-RCX
EASY412-DC-TC	EASY512-DC-TC
EASY412-DC-TCX	EASY512-DC-TCX
–	EASY719-AB-RC
–	EASY719-AB-RCX
EASY619-AC-RC	EASY719-AC-RC
EASY619-AC-RCX	EASY719-AC-RCX
–	EASY719-DA-RC
–	EASY719-DA-RCX
EASY619-DC-RC	EASY719-DC-RC
EASY619-DC-RCX	EASY719-DC-RCX
EASY621-DC-TC	EASY721-DC-TC
EASY621-DC-TCX	EASY721-DC-TCX

easy operation

Buttons



DEL: Delete object in circuit diagram

ALT: Special functions in circuit diagram, Status display

Cursor buttons < > ^ \:

Move cursor

Select menu items

Set contact numbers, contacts and values

OK: Next menu level, Save your entry

ESC: Previous menu level, Cancel

Moving through menus and choosing values

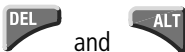

Show System menu



Go to next menu level

Select menu item

Store your entry



Return to last menu level

Cancel your entry since the last **OK**



^ \ Change menu item

Change value

< > Change position

P button function (if enabled):

< Input P1

^ Input P2

> Input P3

\ Input P4

Selecting main and system menu

Status display

easy500: 8 inputs, 4 outputs

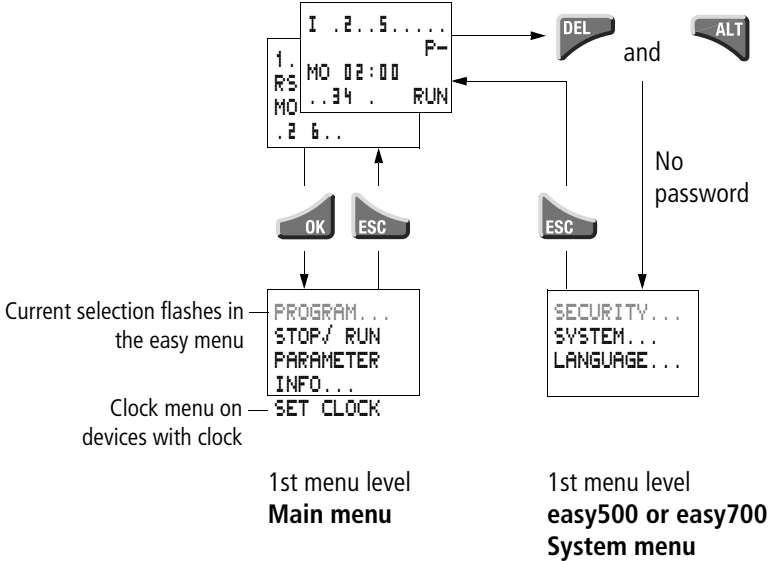

Current selection flashes in the easy menu

Clock menu on devices with clock
SET CLOCK

1st menu level
Main menu

1st menu level
easy500 or easy700 System menu

```

SECURITY...
SYSTEM...
LANGUAGE...
CONFIGURATOR
  
```

The CONFIGURATOR menu appears if a configurable expansion module is connected such as EASY204-DP (Profibus-DP bus gateway)

toggling between weekday, time display and date display

(only on devices with clock)

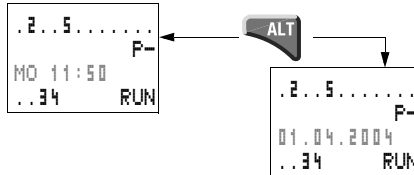

easy Status display

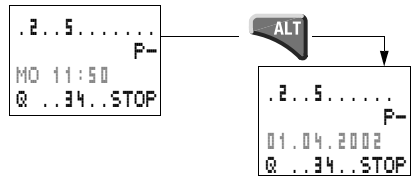

easy500: input 1 to 8,
easy700: input 1 to 12

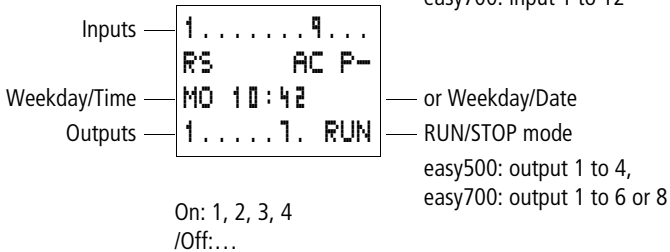

Status display for local expansion

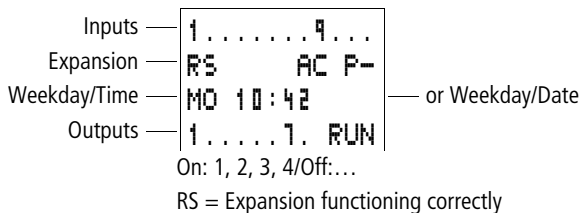

Advanced Status display

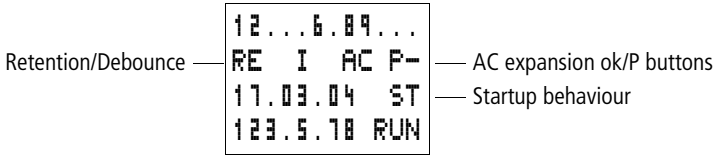

- RE** : Retention switched on
- I** : Debounce switched on
- AC** : AC expansion functioning correctly
- DC** : DC expansion functioning correctly
- GW** : Bus coupling module detected
 GW flashes: Only easy200-easy detected. I/O expansion not detected.
- 17.03.04 Display of actual device date
- ST** : When the power supply is switched on, easy switches to STOP mode

easy LED display

easy512-...X, easy700 and easy-E feature an LED on the front indicating the status of the power supply as well as whether RUN or STOP mode is active (→ figure 2, page 15).

LED OFF	No power supply
LED continuously lit	Power supply present, STOP mode
LED flashing	Power supply present, RUN mode

Menu structure

Main menu without password protection

► You access the main menu by pressing OK.

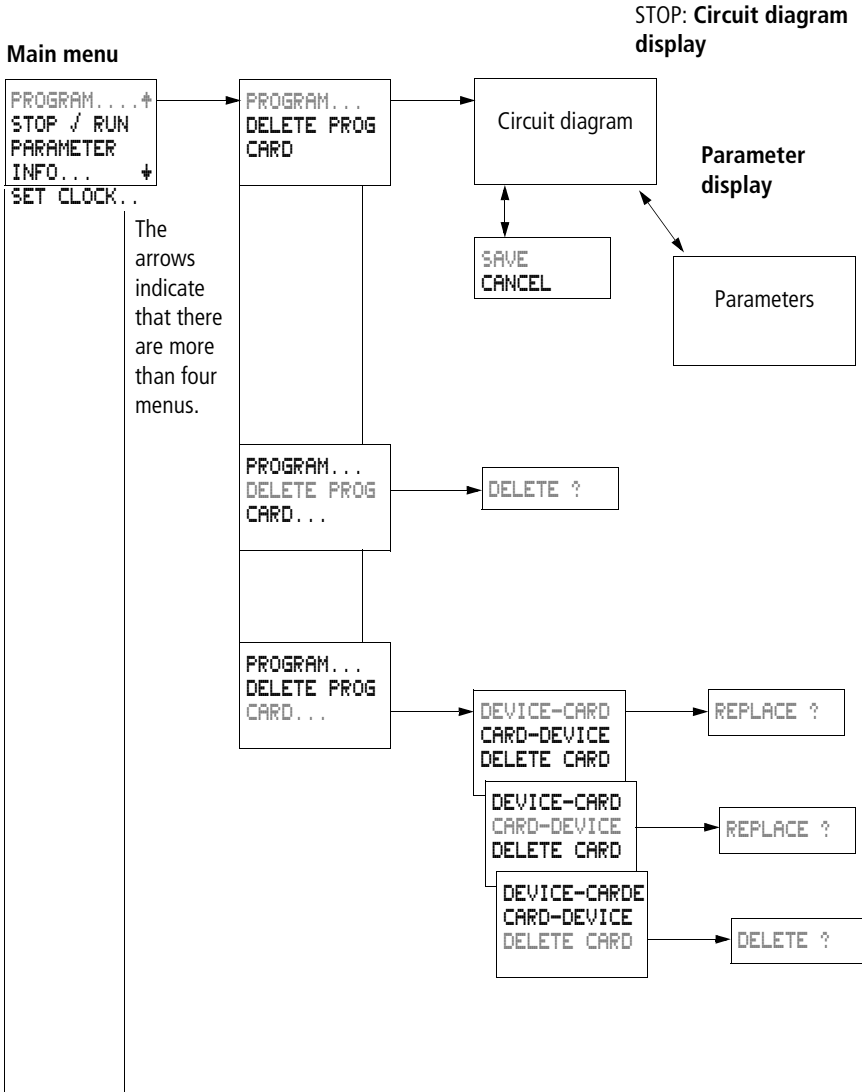

Main menu



Parameter display

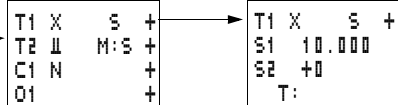

Information display of the device

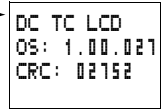

Display for date and time setting

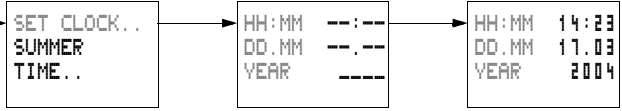

Main menu

Only one selection is possible.

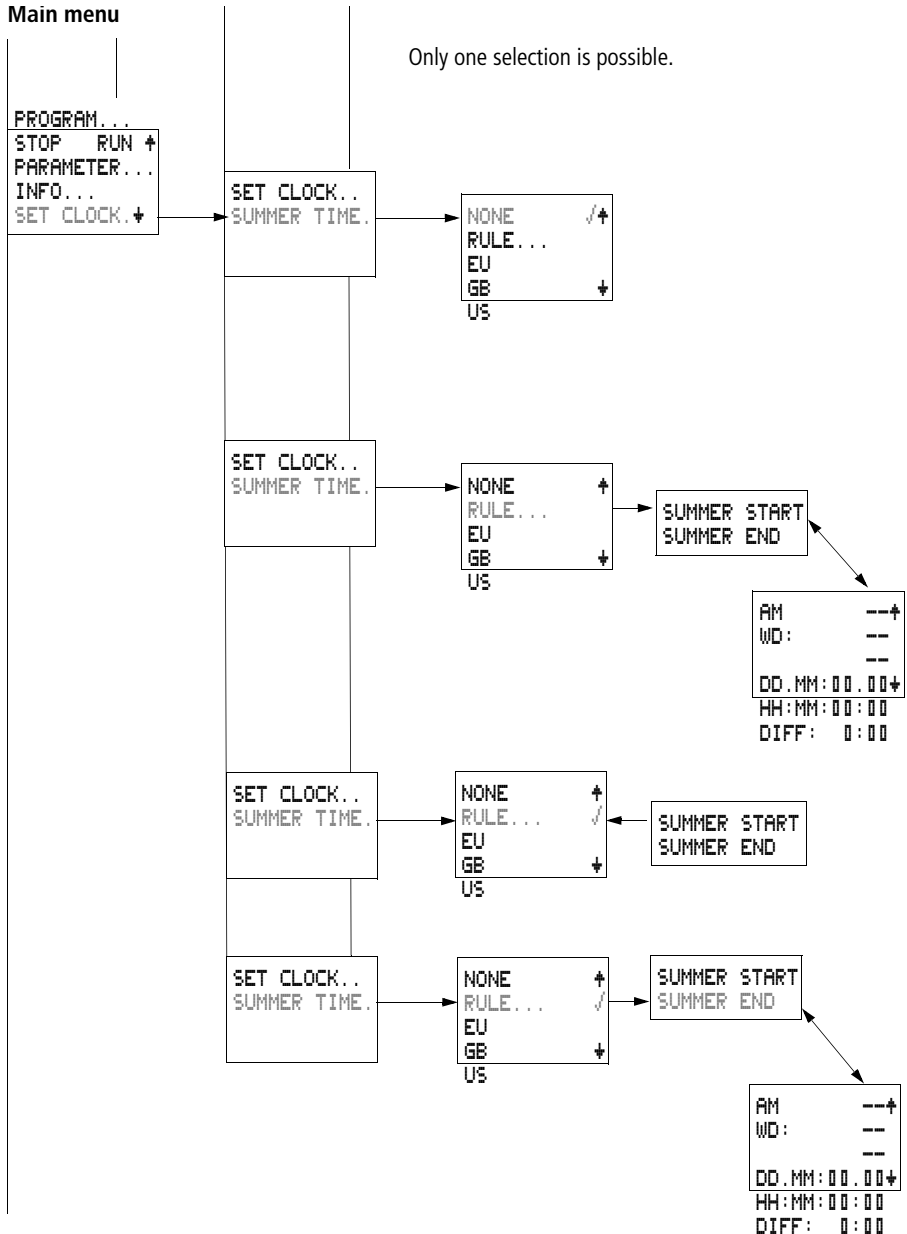

Main menu with password protection

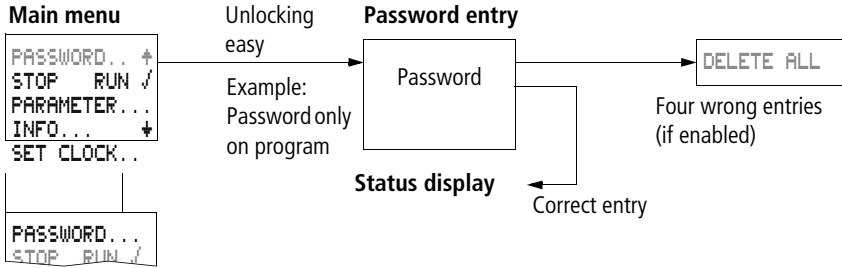

easy System menu

The System menu is accessed by simultaneously pressing DEL and ALT.

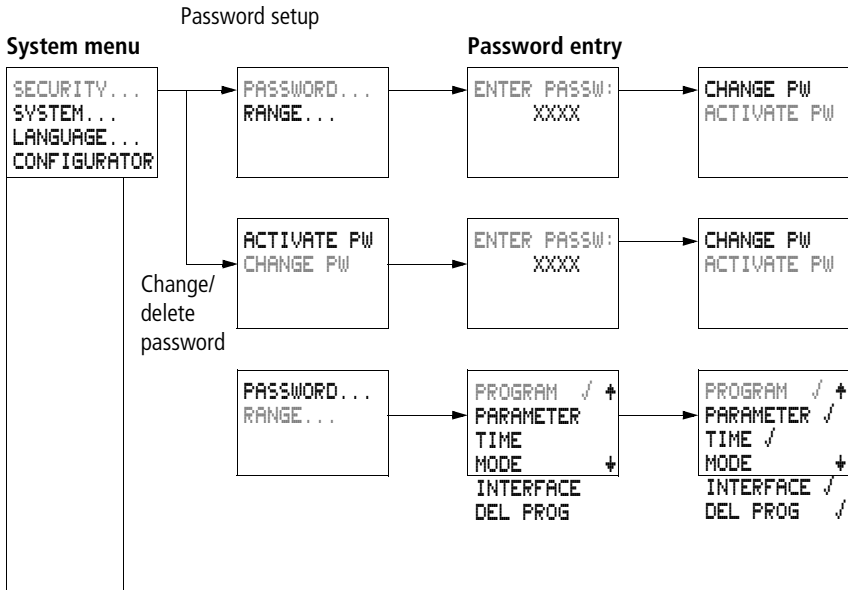

System menu

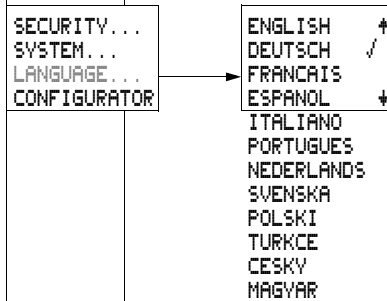
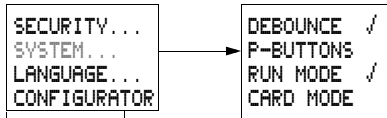

Only one selection is possible.

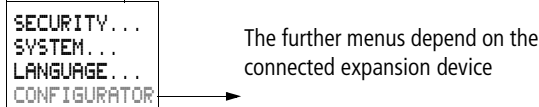

Selecting or toggling between menu items

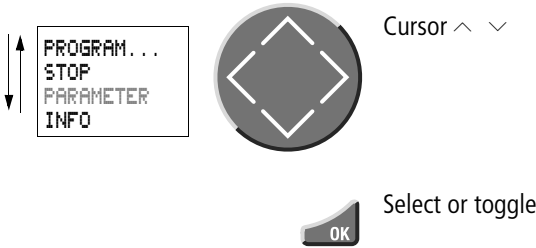

Cursor display

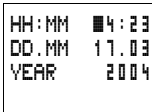

The cursor flashes.

Full cursor █/:

- Move cursor with < >
- in circuit diagram also with ^ v

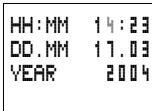

Value M/M

- Change position with < >
- Change values with ^ v

Flashing values/menus are shown in grey in this manual.

Setting values

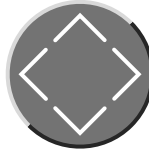
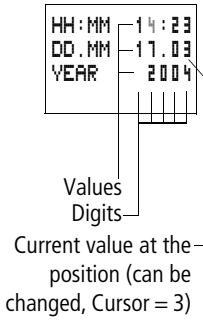

Select value ^ ∨

Select digit < >

Change value at digit ^ ∨



Store entries



Retain previous value

2 Installation

easy must only be installed and wired up by trained electricians or other persons familiar with the installation of electrical equipment.



Danger of electric shock

Never carry out electrical work on the device while the power supply is switched on.

Always follow the safety rules:

- Switch off and isolate
- Secure against reclosing
- Ensure that the device is no longer live
- Cover adjacent live parts

easy is installed in the following order:

- If necessary connect devices together
- Mounting
- Wiring up the inputs
- Wiring up the outputs
- Connecting the power supply

Mounting

Install easy in a control cabinet, service distribution board or in an enclosure so that the power feed and terminal connections cannot be touched accidentally during operation.

Clip easy onto a DIN EN 50022 top-hat rail or fix easy in place using fixing brackets. easy can be mounted vertically or horizontally.



When using easy with expansion units, connect the expansion concerned before mounting (→ page 34).

For ease of wiring, leave a gap of at least 30 cm between easy terminals and the wall or adjacent devices.

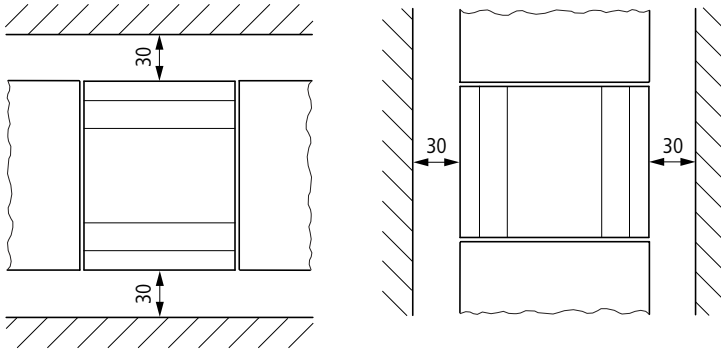
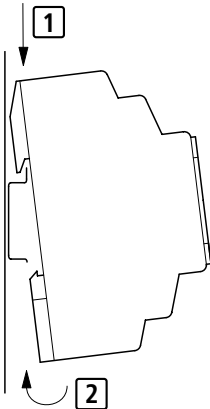

Figure 4: Clearances to easy



Mounting on top-hat rail

► Hook easy to the top edge of the top-hat rail and hinge into place while pressing down slightly. Press the device lightly downwards and against the top-hat rail until it snaps over the lower edge of the top-hat rail.

easy will clip into place and will be secured by the built-in spring mechanism.

► Check that the device is seated firmly.

easy is mounted vertically on a top-hat rail in the same way.

Using a mounting plate

Mounting on a mounting plate requires the use of fixing brackets which are fixed to the back of easy. The fixing brackets are available as an accessory.

easy600 and easy700: Fasten each device with at least three fixing brackets.

EASY200-EASY:

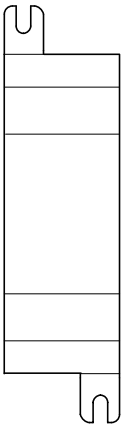

easy500:

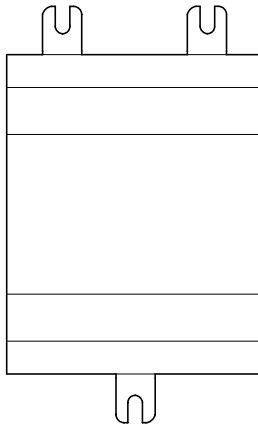

easy600, easy700:

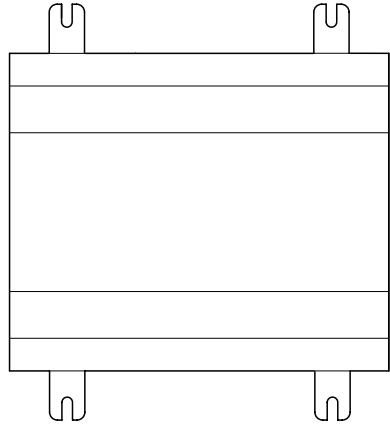

Figure 5: Using a mounting plate

Connecting the expansion device

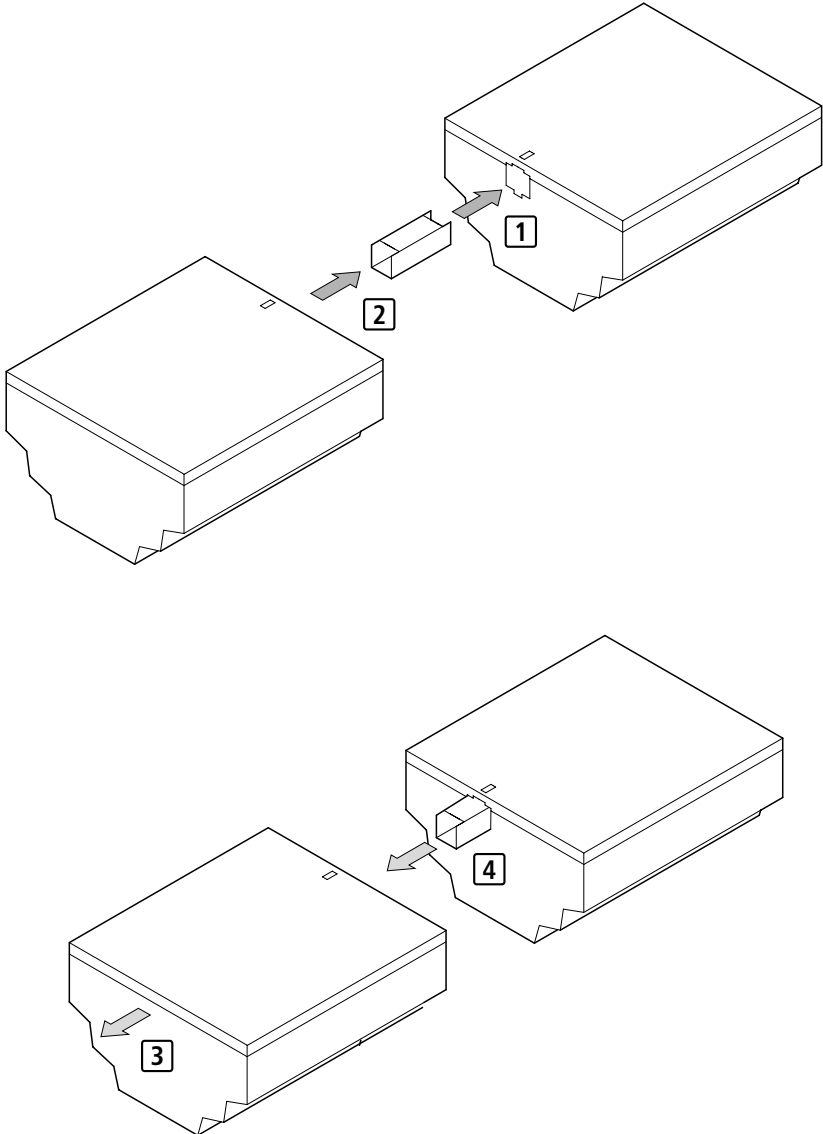

Figure 6: Connecting expansion units

- ▶ Open the easy-LINK connections on the side of both easy devices.
- ▶ Fit the easy-LINK data connector EASY-LINK-DS in the opening provided on the expansion device.
- ▶ Plug the devices together.
- ▶ Proceed in the reverse order to dismantle the device.

Terminals

Tools

Slot-head screwdriver, width 3.5 mm, tightening torque 0.6 Nm.

Cable cross-sections

- Solid: 0.2 to 4 mm²
- Flexible with ferrule: 0.2 to 2.5 mm²

Connecting the power supply



The required connection data for device types , **easy-AB with 24 V AC**, **easy-AC** with standard voltages of 100 V AC, **easy-DA** with 12 V DC and **easy-DC** with 24 V DC are provided in the section "Technical Data", page 262.

The easy500 and easy700 basic units run a system test for two seconds after the power supply has been switched on. Either RUN or STOP mode will be activated after these two seconds, depending on the default setting.

Cable protection

Connect on easy cable protection (F1) rated for at least 1 A (slow).

Supplying AC units

Supplying AC basic units

EASY...-AB-RC(RCX), EASY...-AC-R(RC, RCX)

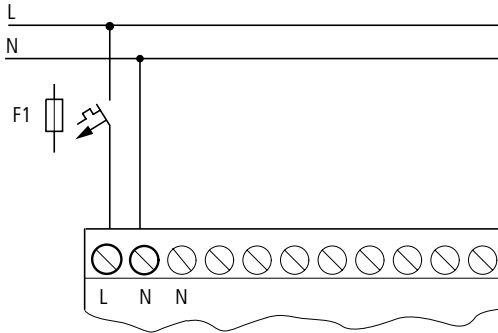

Figure 7: Power supply on the AC basic units

Supplying AC expansion units

EASY...-AC-.E

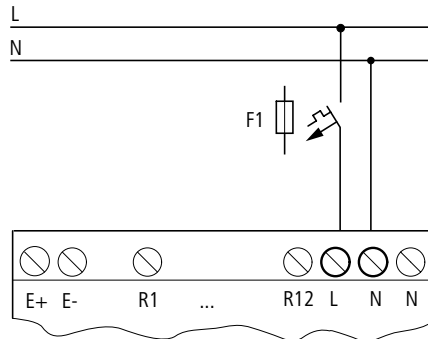

Figure 8: Power supply on the AC expansion units



Applies to easy-AC devices with a power supply greater than 24 V AC:

- The voltage terminals for phase L and neutral conductor N have been reversed.
- This enables the easy interface (for memory card or PC connection) to have the full connection voltage of the phase conductor (100 to 240 V AC).
- There is a danger of electric shock if the connection at the easy interface is not properly connected or if conductive objects are inserted into the socket.



Attention!

A short current surge will be produced when switching on for the first time. Do not switch on easy by means of reed contacts since these may burn or melt.

Supplying DC units

Supplying DC basic units

EASY...-DA-RC(X), EASY...-DC-R(RC,RCX)

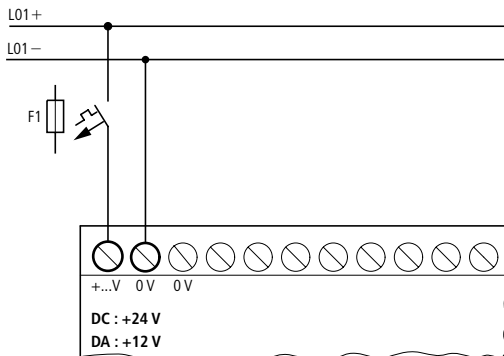

Figure 9: Power supply on the DC basic units

Supplying DC expansion units EASY...-DC-E

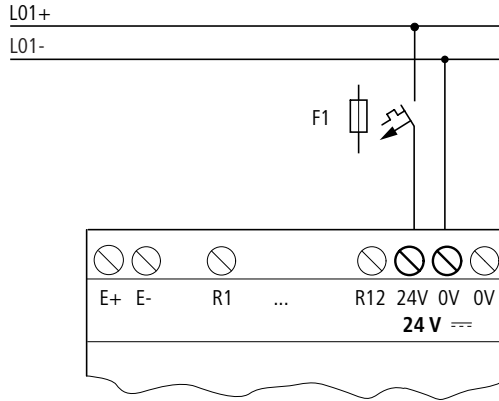

Figure 10: Power supply on the DC expansion units



easy-DC and easy-DA are protected against reverse polarity. To ensure that easy works correctly, ensure that the polarity of each terminal is correct.

Cable protection

Connect on easy a cable protection (F1) rated for at least 1 A (slow).



When easy is switched on for the first time, its power supply circuit behaves like a capacitor. Use an appropriate device for switching on the power supply and do not use any reed relay contacts or proximity switches.

Connecting the inputs

easy inputs switch electronically. Once you have connected a contact via an input terminal, you can reuse it as a contact in your easy circuit diagram as often as you like.

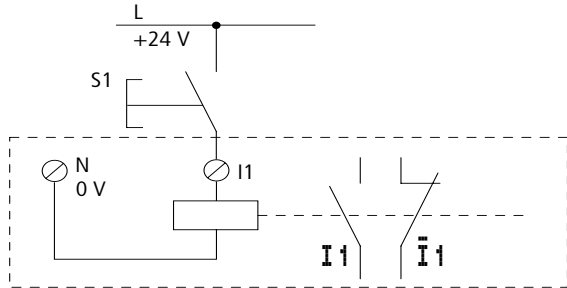

Figure 11: Connecting the inputs

Connect to the easy input terminals contacts such as pushbuttons, switches, relay or contactor contacts, proximity switches (three-wire).

Connecting easy AC digital inputs



Caution!

Connect the inputs for AC devices in compliance with the safety regulations of the VDE, IEC, UL and CSA. Use the same phase conductor for the input power feed, otherwise easy will not detect the switching level and may be damaged or destroyed by overvoltage.

Connecting easy AC digital inputs on the basic unit

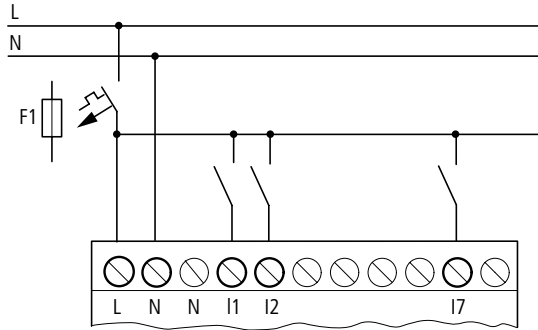

Figure 12: Connecting easy-AC and easy-AB digital inputs

Connecting AC digital inputs on the expansion device

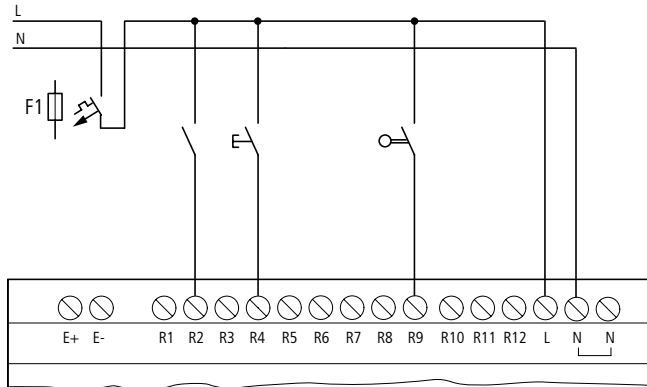

Figure 13: Connecting EASY...-AC-E digital inputs

Table 2: easy-AB input signal values

		Input signal voltage range		Input current
		OFF signal	ON signal	
easy500/ easy700	I1 to I6	0 to 6 V AC	14 to 26.4 V AC	4 mA at 24 V AC
	I7, I8		greater than 7 V AC or greater than 9.5 V DC	2 mA with 24 V AC and 24 V DC
easy700	I9, I10		14 to 26.4 V AC	4 mA at 24 V AC
	I11, I12		greater than 7 V AC or greater than 9.5 V DC	2 mA with 24 V AC and 24 V DC

Table 3: easy-AC input signals

		Input signal voltage range		Input current
		OFF signal	ON signal	
easy500/ easy700	I1 to I6	0 to 40 V	79 to 264 V	0.5 mA at 230 V AC/ 0.25 mA at 115 V AC
	I7, I8			6 mA at 230 V AC/4 mA at 115 V
easy700	I9 to I12			0.5 mA at 230 V AC/ 0.25 mA at 115 V AC
easy600	R1 to R12			

Cable lengths

Severe interference can cause a "1" signal on the inputs without a proper signal being applied. Observe therefore the following maximum cable lengths:

I1 to I6	40 m without additional circuit
I7, I8	100 m without additional circuit
I9 to I12	40 m without additional circuit
R1 to R12	

For longer lengths connect in series a diode (e.g. 1N4007) for 1 A, min. 1000 V reverse voltage, to the easy input. Ensure that the diode is pointing towards the input as shown in the circuit diagram, otherwise easy will not detect the 1 state.

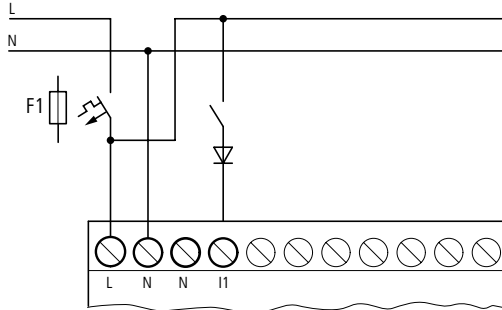

Figure 14: AC input with suppression diode for easy-AC and easy-AB

easy-AC:

Inputs I7 and I8 have a higher input current on the easy-AC. Neon bulbs with a maximum residual current of 2 mA/1 mA at 230 V/115 V can be connected to I7 and I8.



Always use neon bulbs that are operated with a separate N connection.



Caution!

Do not use reed relay contacts at I7, I8. These may burn or melt due to the high inrush current of I7, I8.

Two-wire proximity switches have a residual current with the "0" state. If this residual current is too high, the easy input may only detect a "1" signal.

Therefore, use inputs I7 and I8. An additional input circuit is required if more inputs are used.

Increasing the input current

The following input circuit can be used in order to prevent interference and also when using two-wire proximity switches:

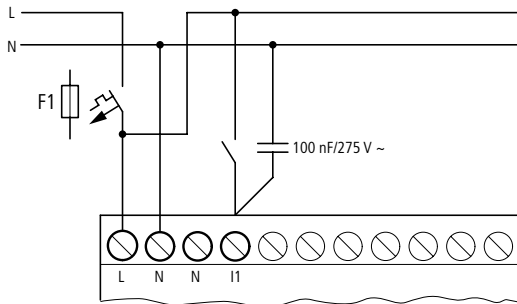

Figure 15: Increasing the input current



When using a 100 nF capacitor the drop-off time of the input increases by 80 (66.6) ms at 50 (60) Hz.

A resistor can be connected in series with the circuit shown in order to restrict the inrush current.

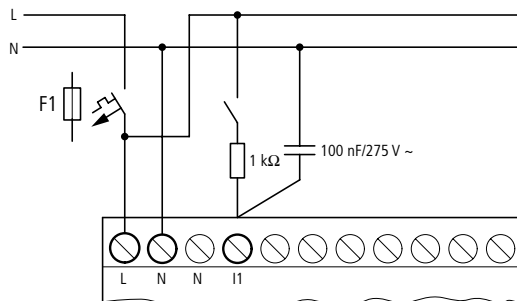

Figure 16: Limitation of the input current with a resistor

Complete devices for increasing the input current are available under the type reference EASY256-HCI.

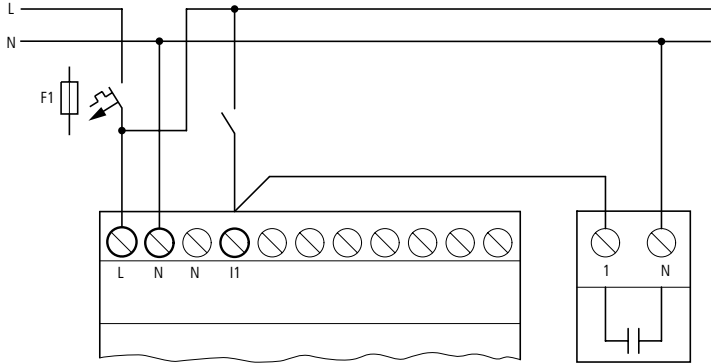

Figure 17: easy with EASY256-HCI



The increased capacitance increases the drop-off time by approx. 40 ms.

Connecting easy DC digital inputs

Use input terminals I1 to I12, R1 to R12 to connect pushbutton actuators, switches or 3 or 4-wire proximity switches. Given the high residual current, do not use 2-wire proximity switches.

Connecting DC digital inputs on the basic unit

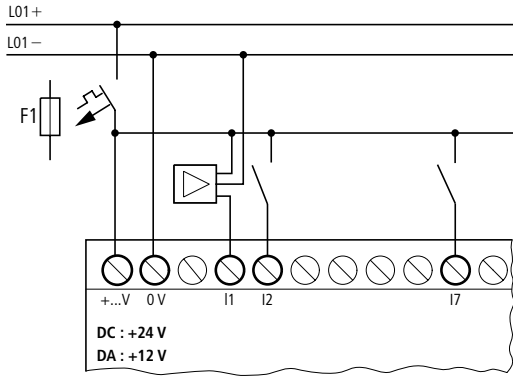
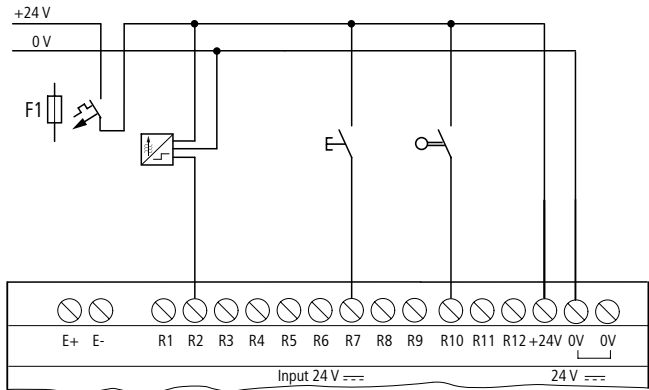

Figure 18: Connecting easy-DC, easy-DA digital inputs

Connecting DC digital inputs on the expansion device



EASY...-DC-.D

Figure 19: Connecting EASY...-DC-E digital inputs

Table 4: easy-DC input signals

		Input signal voltage range		Input current
		OFF signal	ON signal	
easy500/ easy700	I1 to I6	0 to 5 V	15 to 28.8 V	3.3 mA at 24 V DC
	I7, I8		greater than 8 V DC	2.2 mA at 24 V
easy700	I9, I10		15 to 28.8 V	3.3 mA at 24 V DC
	I11, I12		greater than 8 V DC	2.2 mA at 24 V
easy600	R1 to R12		15 to 28.8 V	3.3 mA at 24 V DC

Table 5: easy-DA input signals

		Input signal voltage range		Input current
		OFF signal	ON signal	
easy500/ easy700	I1 to I6	0 to 4 V DC	8 to 15.6 V DC	3.3 mA at 12 V
	I7, I8			1.1 mA at 12 V
easy700	I9, I10			3.3 mA at 12 V
	I11, I12			1.1 mA at 12 V

Connecting easy DC analog inputs

The easy-AB, easy-DA and easy-DC basic units are provided with analog inputs. Inputs I7 and I8, and if present I11 and I12, can be used to connect analog voltages ranging from 0 V to 10 V. A simple additional circuit also allows the analog evaluation of currents from 0 to 20 mA. The analog input signals are converted to 10-bit digital signals.

The following applies:

- 0 V DC corresponds to a digital 0.
- 5 V DC corresponds to a digital value of 512.
- 10 V DC corresponds to a digital value of 1023.

**Caution!**

Analog signals are more sensitive to interference than digital signals. Consequently, greater care must be taken when laying and connecting the signal lines.

Incorrect switching states may occur if they are not connected correctly.

Safety measures with analog signals

- ▶ Use shielded twisted pair cables to prevent interference with the analog signals.
- ▶ For short cable lengths, ground the shield at both ends using a large contact area. If the cable length exceeds 30 m or so, grounding at both ends can result in equalisation currents between the two grounding points and thus in the interference of analog signals. In this case, only ground the cable at one end.
- ▶ Do not lay signal lines parallel to power cables.
- ▶ Connect inductive loads to be switched via the easy outputs to a separate power feed, or use a suppressor circuit for motors and valves. If loads such as motors, solenoid valves or contactors are operated with easy via the same power feed, switching may result in interference on the analog input signals.

The following four circuits contain examples of applications for analog value processing.

**Caution!**

Ensure that the reference potential is connected. Connect the 0 V of the power supply unit for the different setpoint potentiometers and sensors shown in the examples to the 0 V and neutral conductor terminal (easy-AB) of the easy power feed. Otherwise incorrect switching states may occur if they are not connected correctly.

Power supply of easy-AB devices and analog inputs

With easy-AB devices that process analog signals, the device must be fed via a transformer so that the device is isolated from the mains supply. The neutral conductor and the reference potential of the DC power feed of analog sensors must be electrically connected.



Ensure that the common reference potential is grounded or monitored by a ground fault monitoring device. Observe the requirements of the relevant regulations.

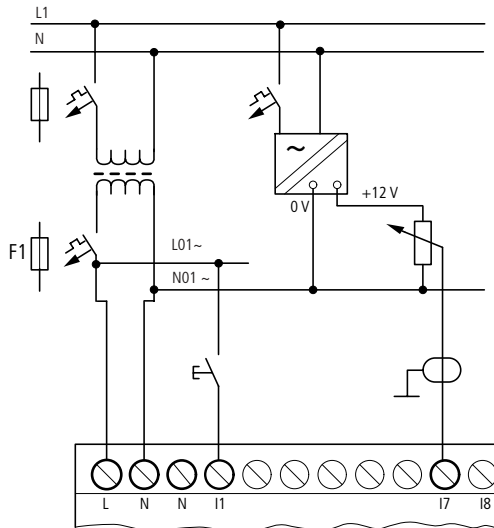

Figure 20: easy-AB analog input, connection of reference potentials

Analog setpoint potentiometer, easy-AB, easy-DA, easy-DC

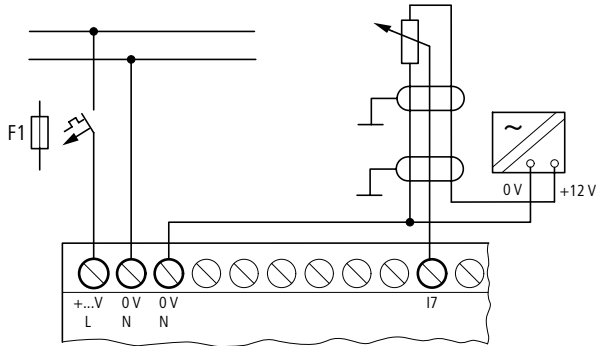

Figure 21: Analog setpoint potentiometer with own power feed

Use a potentiometer with a resistance of $\leq 1\text{ k}\Omega$, e.g. $1\text{ k}\Omega$, 0.25 W .

easy-DC analog setpoint potentiometer

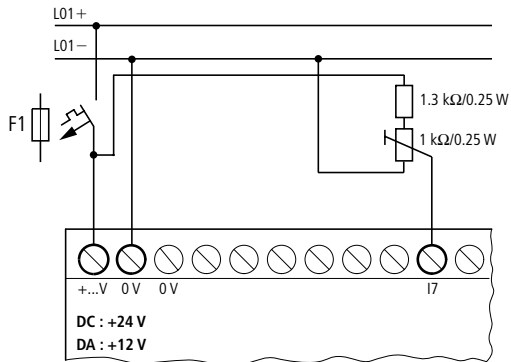

Figure 22: Analog setpoint potentiometer with 24 V DC power feed

Brightness sensor, easy-AB, easy-DA, easy-DC

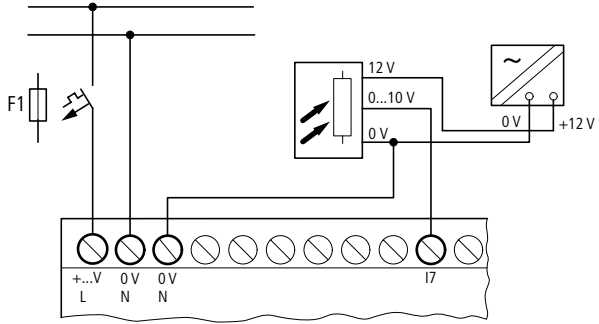

Figure 23: Connection of a brightness sensor, analog input

Temperature sensor, easy-DA, easy-DC

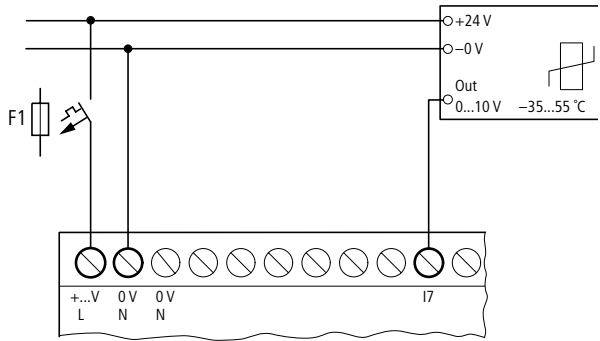

Figure 24: Connection of the temperature sensor, analog input

20 mA sensor

4 to 20 mA (0 to 20 mA) sensors can be connected easily without any problem using an external 500 Ω resistor.

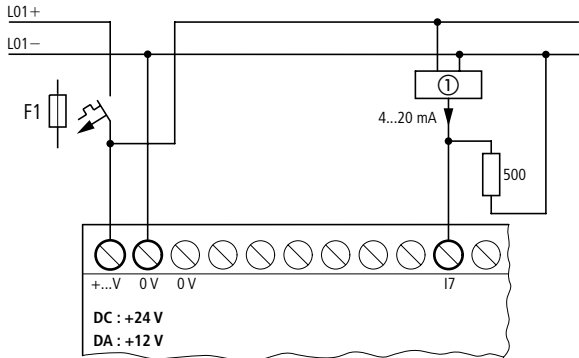

Figure 25: Connection 0 (4) to 20 mA sensor output, analog input

Analog sensor

The following values apply:

- 4 mA = 1.9 V
- 10 mA = 4.8 V
- 20 mA = 9.5 V

(Based on $U = R \times I = 478 \Omega \times 10 \text{ mA} \sim 4.8 \text{ V}$).

Connecting high-speed counters and frequency generators

High-speed counter signals and frequencies on the easy-DA and easy-DA can be counted accurately on inputs I1 to I4 independently of the cycle time. These inputs are permanently assigned to counters.

The following applies:

- I1 = C13 high-speed up/down counter
- I2 = C14 high-speed up/down counter

- I3 = C15 frequency counter
- I4 = C16 frequency counter

Pulse shape of count signals:
easy processes square wave signals.

Mark-to-space ratio of count signals:
We recommend a mark-to-space ratio of 1:1.

If this is not the case:
The minimum pulse or pause duration is 0.5 ms.

$$t_{\min} = 0.5 \times (1/f_{\max})$$

t_{\min} = minimum time of the pulse or pause duration

f_{\max} = maximum count frequency (1 kHz)

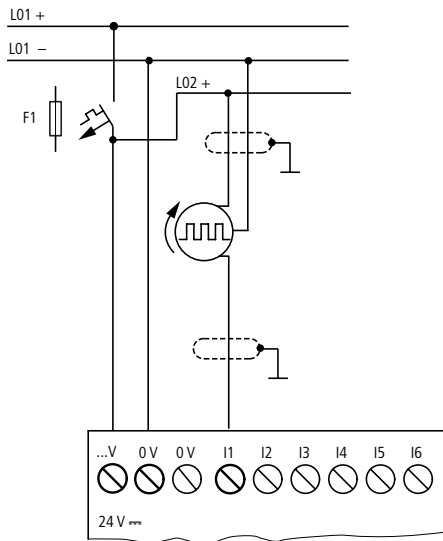

Figure 26: Connecting high-speed counters and frequency generators



Inputs that are used as high-speed counter inputs should not be used in the circuit diagram as contacts. If the counter frequency is high:

Not all the signals of the high-speed counter can be monitored for processing in the circuit diagram. easy will only process a randomly logged state.

Connecting the outputs

The Q outputs function inside easy as isolated contacts.

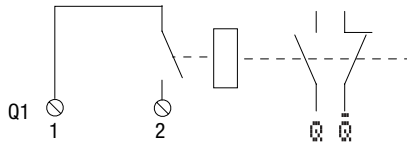

Figure 27: Output Q

The associated relay coils are controlled in the easy circuit diagram via the following outputs.

- Q1 to Q4 and Q1 to Q8 (Q6), basic units
- S1 to S8 (S6), expansion devices

You can use the signal states of the outputs as make or break contacts in the easy circuit diagram to provide additional switching conditions.

The relay or transistor outputs are used to switch loads such as fluorescent tubes, filament bulbs, contactors, relays or motors. Check the technical thresholds and data of the outputs before installation (→ section “Technical Data”, page 262).

Connecting relay outputs

EASY512-...-R..

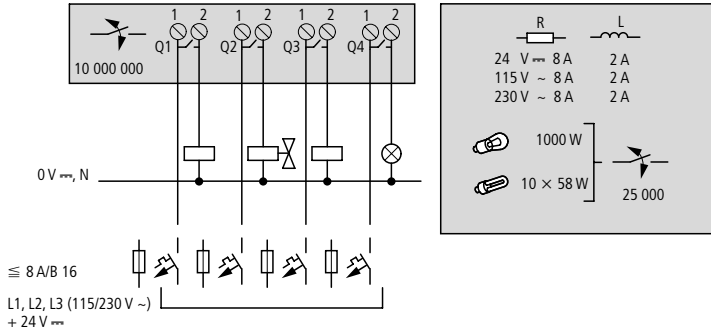

Figure 28: EASY512-...-R.. relay outputs

EASY7...-R.. and

EASY202-RE

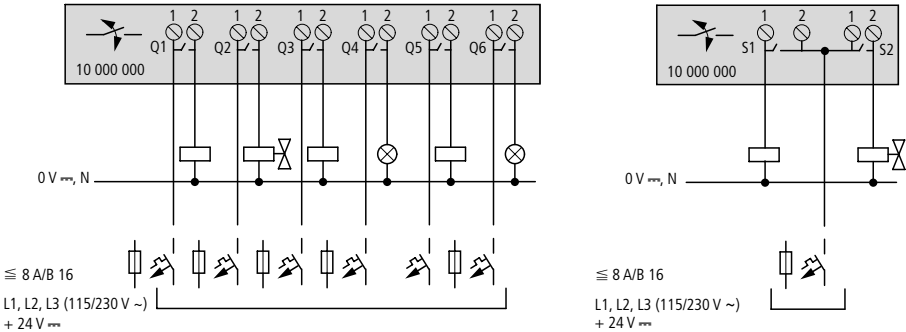

Figure 29: EASY7...-R.. relay outputs and EASY202-RE

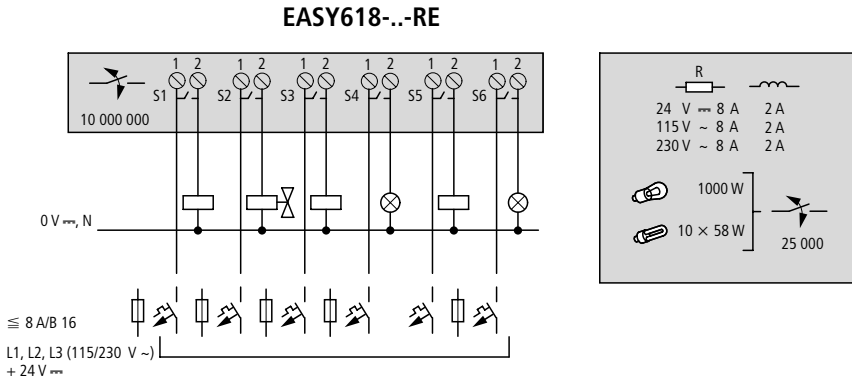

Figure 30: EASY618-...-RE.. relay outputs

Unlike the inputs, the outputs can be connected to different phases.



Warning!

Do not exceed the maximum voltage of 250 V AC on a relay contact.

If the voltage exceeds this threshold, flashover may occur at the contact, resulting in damage to the device or a connected load.

Connecting transistor outputs

EASY512-...-T..

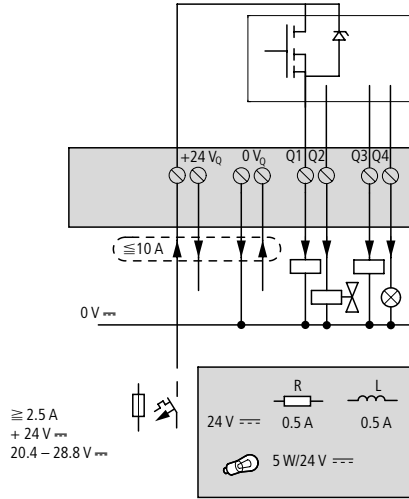

Figure 31: EASY512-...-T.. transistor outputs

EASY7...-T..

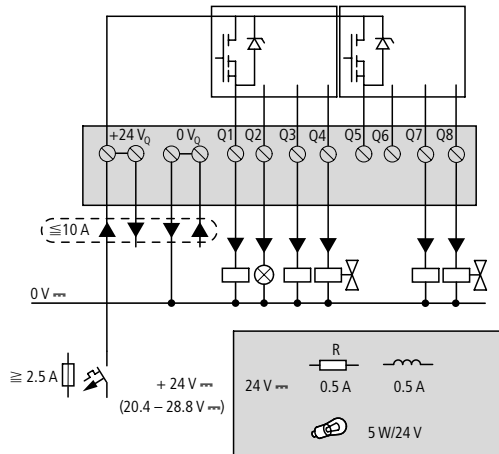

Figure 32: EASY7...-T.. transistor outputs

EASY620-...-TE

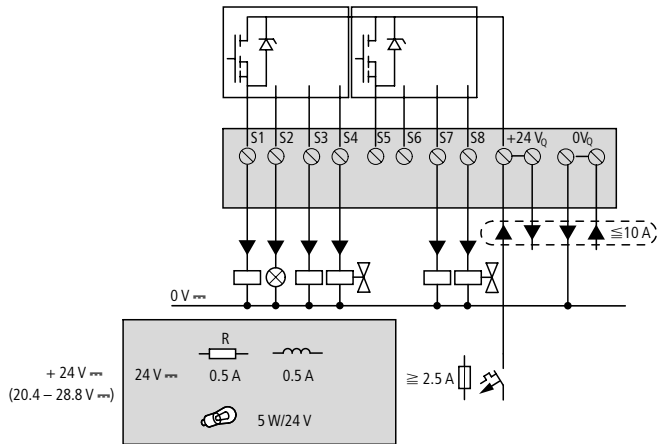

Figure 33: EASY620-...-TE transistor outputs

Parallel connection:

Up to four outputs can be connected in parallel in order to increase the power. The output current will increase in this case to a maximum of 2 A.

**Caution!**

Outputs may only be connected in parallel within a group (Q1 to Q4 or Q5 to Q8, S1 to S4 or S5 to S8), such as Q1 and Q3 or Q5, Q7 and Q8. Outputs connected in parallel must be switched at the same time.

**Caution!**

Please note the following when switching off inductive loads.

Suppressed inductive loads cause less interference in the entire electrical system. For optimum suppression the suppressor circuits are best connected directly to the inductive load.

If inductive loads are not suppressed, the following applies: Several inductive loads should not be switched off simultaneously to avoid overheating the driver blocks in the worst possible case. If in the event of an emergency stop the +24 V DC power supply is to be switched off by means of a contact, and if this would mean switching off more than one controlled output with an inductive load, then you must provide suppressor circuits for these loads (see the following diagrams).

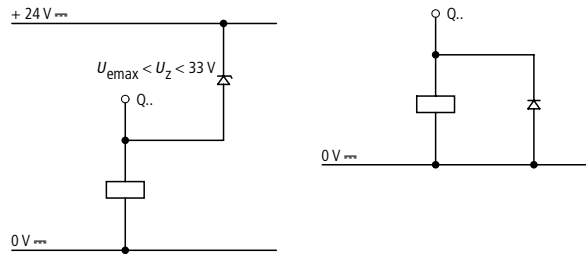

Figure 34: Inductive load with suppressor circuit

Behaviour with short-circuit/overload

Should a short circuit or overload occur on a transistor output, this output will switch off. The output will switch on up to maximum temperature after the cooling time has elapsed. This time depends on the ambient temperature and the current involved. If the fault condition persists, the output will keep switching off and on until the fault is corrected or until the power supply is switched off (→ section "Monitoring of short-circuit/overload with EASY..-D.-T..", page 242).

Expanding inputs/outputs You can add expansion units to the following easy models in order to increase the number of inputs and outputs:

Expandable easy basic units	Expansion units	
EASY7...-R.. EASY7...-T..	EASY618...-RE	115/230 V AC power supply <ul style="list-style-type: none"> • 12 AC inputs, • 6 relay outputs 24 V DC power supply <ul style="list-style-type: none"> • 12 DC inputs, • 6 relay outputs
	EASY620...-TE	<ul style="list-style-type: none"> • 12 DC inputs, • 8 transistor outputs
	EASY202-RE	2 relay outputs
	Special expansion units see current catalogue	

Local expansion

Local expansion units are connected directly next to the basic unit.

- ▶ Connect the easy expansion unit via the EASY-LINK connection.

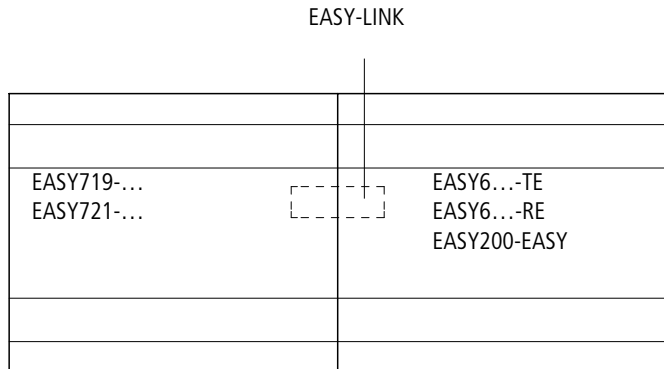

Figure 35: Connecting local expansion with easy

**Warning!**

The following electrical isolation is implemented between the EASY7...-C. basic unit and the expansion device (isolation always in local connection of expansion unit)

- Basic isolation 400 V AC (+10 %)
- Safe isolation 240 V AC (+10 %)

Units may be destroyed if the value 400 V AC +10 % is exceeded, and may cause the malfunction of the entire system or machine!



Basic unit and expansion unit can be provided with different DC power supplies.

Remote expansion

Remote expansion units can be installed and run up to 30 m away from the basic unit.

**Warning!**

The two-wire or multi-core cable between units must have the necessary insulation voltage required for the installation environment concerned. In the event of a fault (ground leakage, short-circuit) serious damage or injury to persons may otherwise occur.

A cable such as NYM-0 with a rated operational voltage of $U_e = 300/500$ V AC is normally sufficient.

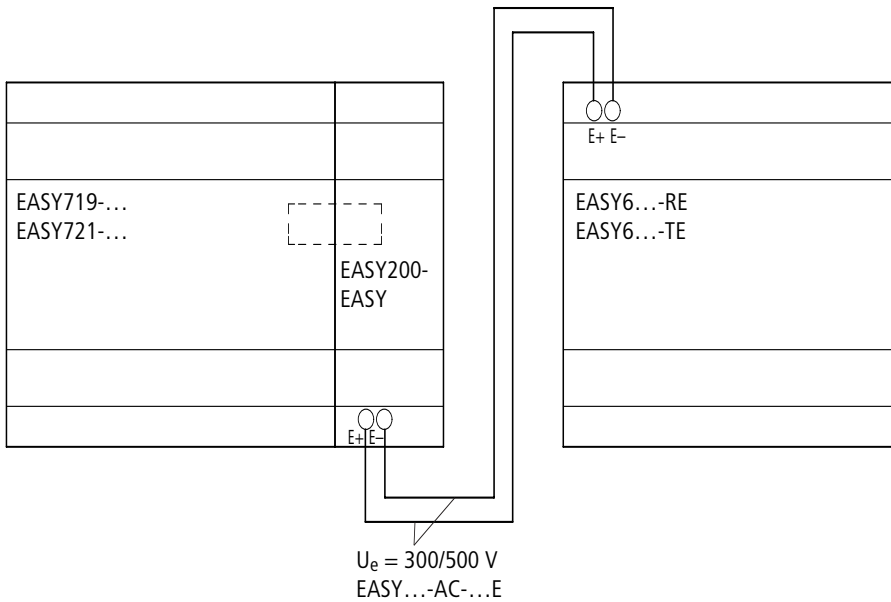

Figure 36: Connecting remote expansion units to easy



Terminals E+ and E- of the EASY200-EASY are protected against short-circuits and polarity reversal. Functionality is only ensured if "E+" is connected with "E+" and "E-" with "E-".

Connecting bus systems

The EASY-LINK connection is designed to allow bus connections, apart from I/O expansions. Special bus connection devices are available for the bus systems in use.



Only one device (expansion device or bus connection) can be connected to the EASY-LINK connection.

At present, easy700 can communicate with the following bus systems or networks:

- AS-Interface (Actuator-Sensor Interface)
- Profibus-DP
- CANopen
- DeviceNET

The different bus systems offer different functions.

The following applies:

- As a minimum data exchange, the input data R1 to R16 and output data S1 to S8 can be exchanged, provided that the bus system supports this.
- If the bus system or bus gateway is capable of this, function block, date, time parameters can be read and written via the bus. The states of inputs, outputs, markers can be read.



The range and the functions of the bus gateways are being continually further developed.

The current Moeller product line catalogue and the Internet online catalogue contain those bus gateways that are currently available.

3 Commissioning

Switching on

Before switching on easy, check that you have connected the power supply terminals and inputs correctly:

- 24 V AC version easy-AB
 - Terminal L: Phase conductor L
 - Terminal N: Neutral conductor N
 - Terminals I1 to I12:
 - Actuation via same phase conductor L
- 230 V AC version easy-AC
 - Terminal L: Phase conductor L
 - Terminal N: Neutral conductor N
 - Terminals I1 to I12, R1 to R12:
 - Actuation via phase conductor L
- 12 V DC version:
 - Terminal +12 V: Voltage +12 V
 - Terminal 0 V: 0 V voltage
 - Terminals I1 to I12:
 - Actuation via same +12V
- 24 V DC version:
 - Terminal +24 V: +24 V voltage
 - Terminal 0 V: 0 V voltage
 - Terminals I1 to I12, R1 to R12:
 - Actuation via the same +24 V

If you have already integrated easy into a system, secure any parts of the system connected to the working area to prevent access and ensure that no-one can be injured if, for example, motors start up unexpectedly.

Setting the menu language

When you switch on easy for the first time, you will be asked to select the menu language.



► Use the cursor buttons \wedge or \vee to select the language required.

- English
- German
- French
- Spanish
- Italian
- Portuguese
- Dutch
- Swedish
- Polish
- Turkish
- Czech
- Hungarian

► Press **OK** to confirm your choice and press **ESC** to exit the menu.

easy will then switch to the Status display.



You can change the language setting at a later time (→ section “Changing the menu language”, page 209).

If you do not set the language, easy will display this menu and wait for you to select a language every time you switch on.

easy operating modes

easy has two operating modes - RUN and STOP.

In RUN mode easy continuously processes a stored circuit diagram until you select STOP or disconnect the power. The circuit diagram, parameters and the easy settings are retained in the event of a power failure. All you will have to do is reset the real-time clock after the back-up time has elapsed. Circuit diagram entry is only possible in STOP mode.



Caution!

In RUN mode easy will immediately run the saved circuit diagram in the unit when the power supply is switched on. This will happen unless STOP mode was set as startup mode. In RUN mode outputs are activated according to the switch logic of the circuit diagram.

When a memory card with a circuit diagram is fitted in an easy model with an LCD display, this circuit diagram will not start automatically if there is circuit diagram in the device. The circuit diagram must first be transferred from the memory card to the easy unit.

In RUN mode easy-X models load the circuit diagram on the memory card automatically and run it immediately.

Creating your first circuit diagram

The following small circuit diagram takes you step by step through wiring up your first easy circuit diagram. In this way you will learn all the rules, quickly enabling you to use easy for your own projects.

As with conventional wiring, you use contacts and relays in the easy circuit diagram. With easy, however, you no longer have to connect up components individually. At the push of a few buttons, the easy circuit diagram produces all the wiring. All you have to do is then connect any switches, sensors, lamps or contactors you wish to use.

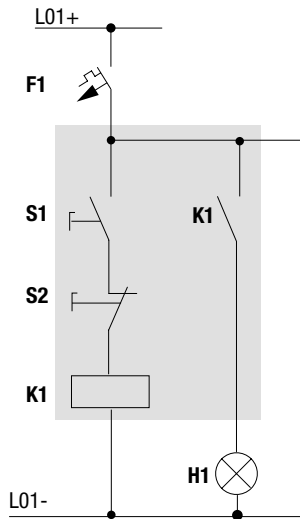

Figure 37: Lamp controller with relays

In the following example, easy carries out all the wiring and performs the tasks of the circuit diagram shown below.

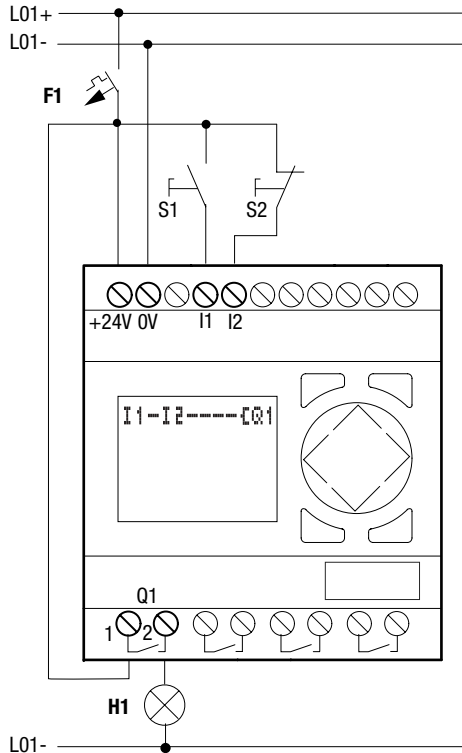
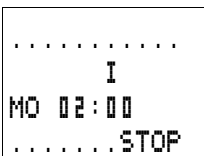

Figure 38: Lamp controller with easy

Starting point: the Status display

When you switch on easy, it opens the Status display immediately to show the switching state of the inputs and outputs. It also indicates whether easy is already running a circuit diagram.



The examples were written without the use of expansion units. If an expansion unit is connected, the Status display will first show the status of the basic unit and then the status of the expansion unit before showing the first selection menu.



► Press **OK** to switch to the main menu.

Press **OK** to switch to the next menu level, and press **ESC** to move one level back.



OK has two other functions:

- Press **OK** to save modified settings.
- In the circuit diagram, you can also press **OK** to insert and modify contacts and relay coils.

In this case easy must be in STOP mode.

► Press **OK 2 ×** to enter the circuit diagram display via menu items PROGRAM... → PROGRAM. This is where you will create the circuit diagram.

Circuit diagram display

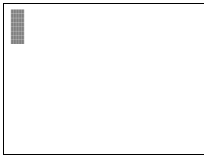

The circuit diagram display is currently empty. The cursor flashes at the top left, which is where you will start to wire your circuit diagram. easy will automatically propose the first contact **I 1**.

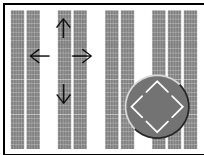

Use the ^ v < > cursor buttons to move the cursor over the invisible circuit diagram grid.

The first three double columns are the contact fields and the right-hand columns form the coil field. Each line is a rung. easy automatically energizes the first contact to voltage.

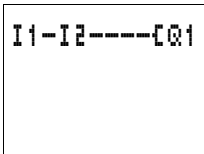

► Now try to wire up the following easy circuit diagram. Switches S1 and S2 are at the input. **I 1** and **I 2** are the contacts for the input terminals. Relay K1 is represented by the relay coil **C 01**. The symbol **C** identifies the coil's function, in this case a relay coil acting as a contactor. **01** is one of up to eight easy output relays in the basic unit.

From the first contact to the output coil

With easy, you work from the input to the output. The first input contact is **I 1**.

- ▶ Press **OK**.

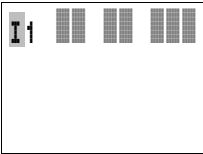

easy inserts the first contact **I 1** at the cursor position.

- ▶ The **I** flashes and can be changed, for example, to a **F** for a button input by using the cursor buttons **^** or **∨**. However, nothing needs to be changed at this point.
- ▶ Press **OK 2 ×**, to move the cursor across the **1** to the second contact field.

You could also move the cursor to the next contact field using the cursor button **>**.

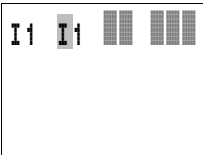

- ▶ Press **OK**.

Again, easy creates a contact **I 1** at the cursor position. Change the contact number to **I 2** so that break contact S2 can be connected to input terminal I2.

- ▶ Press **OK** so that the cursor jumps to the next position and use cursor buttons **^** or **∨** to change the number to **2**.



Press **DEL** to delete a contact at the cursor position.

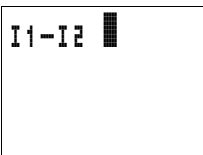

- ▶ Press **OK** to move the cursor to the third contact field. You do not need a third switch contact, so you can now wire the contacts directly to the coil field.

Wiring

easy displays a small arrow in the circuit diagram for creating the wiring.

Press **ALT** to activate the arrow and press the cursor buttons $\wedge \vee < >$ to move it.



ALT also has two other functions depending on the cursor position:

- From the left contact field, press **ALT** to insert a new, empty rung.
- The contact under the cursor can be changed between a make and break contact by pressing the **ALT** button.

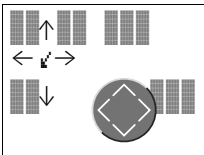

The wiring arrow works between contacts and relays. When you move the arrow onto a contact or relay coil, it changes back to the cursor and can be reactivated if required.



easy automatically wires adjacent contacts in a rung up to the coil.

- ▶ Press **ALT** to wire the cursor from **I 2** through to the coil field.

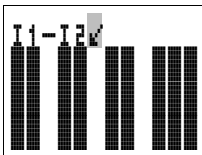

The cursor changes into a flashing wiring arrow and automatically jumps to the next logical wiring position.

- ▶ Press the cursor button $>$. Contact **I 2** will be connected up to the coil field.



You can use the **DEL** button to erase a connection at the cursor or arrow position. Where connections intersect, the vertical connections are deleted first, then, if you press **DEL** again, the horizontal connections are deleted.

- ▶ Press the cursor button $>$ once more.

The cursor will move to the coil field.

```
I1-I2----CQ1
```

► Press **OK**.

easy will insert relay coil **Q1**. The specified coil function **C** and the output relay **Q1** are correct and do not have to be changed.

```
I1-I2----CQ1
```

Your first working easy circuit diagram now looks like this:

Press **ESC** to leave the circuit diagram display.

```
SAVE
CANCEL
```

The menu shown appears.

► Press **OK**.

The circuit diagram is now automatically saved. **CANCEL** exits the circuit diagram. Changes that have been made to the circuit diagram are not saved.



easy saves all the necessary circuit diagram and program data retentively in the internal data memory.

Once you have connected buttons S1 and S2, you can test your circuit diagram straight away.

Testing the circuit diagram

```
PROGRAM...+
STOP / RUN
PARAMETER..
INFO... +
```

► Switch with **ESC** to the main menu and select the **STOP / RUN** menu option.

With **STOP / RUN /** and **STOP / RUN** you switch to the **RUN** or **STOP** operating modes.

easy is in **RUN** mode if the tick is present at the corresponding menu item. i.e. **STOP / RUN /**.



The tick next to a menu item indicates which operating mode or function is currently active.



▶ Press **OK**.

The tick changes to STOP RUN ✓

The Status display shows the current mode and the switching states of the inputs and outputs.

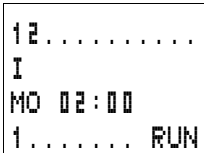

▶ Change to the Status display by pressing **ESC** and press pushbutton actuator S1.

The contacts for inputs I1 and I2 are activated and relay Q1 picks up.

Power flow display

easy allows you to check rungs in RUN mode. This means that you can check your circuit diagram via the built-in power flow display while it is being processed by easy.

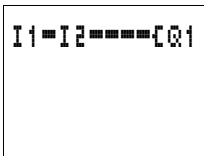

▶ Switch to the circuit diagram display (confirm **PROGRAM** menu with **OK**) and actuate pushbutton S1.

The relay picks up and easy displays the power flow.

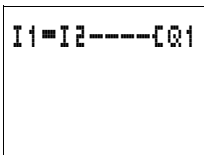

▶ Press pushbutton actuator S2, that has been connected as a break contact.

The rung is interrupted and relay Q1 drops out.

Press **ESC** to return to the Status display.



A circuit diagram does not have to be completed before you can test parts of it with easy.

easy simply ignores any incomplete wiring that is not yet working and only uses the finished wiring.

Deleting the circuit diagram

- ▶ Switch easy to STOP mode.

The display shows **STOP** ✓ **RUN**.



easy must be in STOP mode in order to extend, delete or modify the circuit diagram.

```
PROGRAM
DELETE PROG
```

- ▶ Use **PROGRAM . . .** to switch from the main menu to the next menu level.
- ▶ Select **DELETE PROGRAM**

easy will display the prompt **DELETE?**

- ▶ Press **OK** to delete the program or **ESC** to cancel.

Press **ESC** to return to the Status display.

Fast circuit diagram entry

You can create a circuit diagram in several ways. The first option is to enter the elements in the circuit and then to wire all the elements together. The other option is to use the enhanced operator guidance of easy and create the circuit diagram in one go, from the first contact through to the last coil.

If you use the first option, you will have to select some of the elements in order to create and connect up your circuit diagram.

The second, faster option is what you learned in the example. In this case you create the entire rung from left to right.

4 Wiring with easy

By working through the example in chapter 3 you should now have gained an initial impression of just how simple it is to create a circuit diagram in easy. This chapter describes the full range of easy functions and provides further examples of how to use easy.

Operation of easy

Buttons for editing circuit diagrams and function relays



Delete rung, contact, relay or empty rung in the circuit diagram



Toggle between break and make contact
Connect contacts, relays and rungs
Add rungs



^ v Change value
Move cursor up and down
< > Change position
Move cursor to left and right

Cursor buttons set as P buttons:

<	Input P1,	^	Input P2
>	Input P3,	v	Input P4



Undo setting since previous **OK**
Exit current display or menu





Change, add contact/relay
Save setting

Operation

The cursor buttons in the easy circuit diagram perform three functions. The current mode is indicated by the appearance of the flashing cursor.

- Move
- Enter
- Connect

 In Move mode you can use ^ v < > to move the cursor around the circuit diagram in order to select a rung, contact or relay coil.

 Use **OK** to switch to Entry mode so that you can enter or change a value at the current cursor position. If you press **ESC** in Entry mode, easy will undo the most recent changes.

 Press **ALT** to switch to Connect mode for wiring contacts and relays. Press **ALT** again to return to Move.

Press **ESC** to leave the circuit diagram and parameter display.



easy performs many of these cursor movements automatically. For example, easy switches the cursor to Move mode if no further entries or connections are possible at the selected cursor position.

Opening the parameter display for function relays with contacts or coils

If you specify the contact or coil of a function relay in Entry mode, easy automatically switches from the contact number to the function relay parameter display when you press **OK**.

Press > to switch to the next contact or coil field without entering any parameters.

Program

A program is a sequence of commands which easy executes cyclically in RUN mode. An easy program consists of the necessary settings for the device, password, system settings, a circuit diagram and/or function relays.

Circuit diagram

The circuit diagram is that part of the program where the contacts are connected together. In RUN mode a coil is switched on and off in accordance with the current flow and the coil function specified.

Function relays

Function relays are program elements with special functions. Example: timing relays, time switches, counters. Function relays are elements provided with or without contacts and coils as required. In RUN mode the function relays are processed according to the circuit diagram and the results are updated accordingly.

Examples:

Timing relay = function relay with contacts and coils

Time switch = function relay with contacts

Relay

Relays are switching devices which are electronically simulated in easy. They actuate their contacts according to their designated function. A relay consists of at least a coil and a contact.

Contacts

You modify the current flow with the contacts in the easy circuit diagram. Contacts such as make contacts carry a 1 signal when closed and 0 when open. Every contact in the easy circuit diagram can be defined as either a make contact or a break contact.

Coils

Coils are the actuating mechanisms of relays. In RUN mode, the results of the wiring are sent to the coils, which switch on or off accordingly. Coils can have seven different coil functions.

Table 6: Usable contacts

Contact	easy representation
$\left. \begin{array}{l} \\ \backslash \end{array} \right\}$ Make contact Open in the rest state	I, Q, M, N, A, B, V, C, T, O, P, :, D, S, R, Z
$\left. \begin{array}{l} \backslash \\ \end{array} \right\}$ Break contact Closed in the rest state	$\bar{I}, \bar{Q}, \bar{M}, \bar{N}, \bar{A}, \bar{B}, \bar{V}, \bar{C}, \bar{T}, \bar{O}, \bar{P}, \bar{D},$ $\bar{S}, \bar{R}, \bar{Z}$

easy works with different contacts, which can be used in any order in the contact fields of the circuit diagram.



To ensure compatibility with easy400 and easy600 devices, each easy500 and easy700 is provided logically with all possible contacts. If contacts are not supported by the device, i.e. devices without a clock, their switching state is always zero. The contacts (make contact) of the time switches are always set to logic 0.

The advantage of this process is that you can use the same circuit diagram on all easy500, easy700, easy-AB, easy-AC, easy-DA and easy-DC devices.

Table 7: Contacts

Contact type	Make contact	Break contact	easy500	easy700	Page
Analog value comparator function relay	A	\bar{A}	A1...A16	A1...A16	104
Counter function relay	C	\bar{C}	C1...C16	C1...C16	117
Text marker function relay	D	\bar{D}	D1...D16	D1...D16	137
7-day time switch function relay	B	\bar{B}	B1...B8	B1...B8	143

Contact type	Make contact	Break contact	easy500	easy700	Page
easy input terminal	I	\bar{I}	I1...I8	I1...I12	83
0 signal			I13	I13	
Expansion status			—	I14	245
Short-circuit/overload			I16	I15...I16	245
Marker (auxiliary relay)	M	\bar{M}	M1...M16	M1...M16	91
Marker (auxiliary relay)	N	\bar{N}	N1...N16	N1...N16	91
Operating hours counter	O	\bar{O}	O1...O4	O1...O4	149
Cursor button	P	\bar{P}	P1...P4	P1...P4	89
easy output	Q	\bar{Q}	Q1...Q4	Q1...Q8	83
Expansion input terminal	R	\bar{R}	—	R1...R12	83
Short-circuit/overload with expansion	R	\bar{R}	—	R15...R16	245
easy output (expansion or S auxiliary marker)	S	\bar{S}	S1...S8 (as marker)	S1...S8	91
Timing function relay	T	\bar{T}	T1...T16	T1...T16	154
Jump label	:	—	:1...:8	:1...:8	171
Year time switch	V	\bar{V}	V1...V8	V1...V8	174
Master reset, (central reset)	Z	\bar{Z}	Z1...Z3	Z1...Z3	181

Relay, function relays

easy has nine different types of relay for wiring in a circuit diagram.



To ensure compatibility with easy400 and easy600 devices, each easy500 and easy700 is provided logically with all relay types. If a relay type is not supported by the device, i.e. devices without a clock, their switching state is always zero. The contacts (make contact) of the time switches are always set to logic 0.

The advantage of this process is that you can use the same circuit diagram on all easy500, easy700, easy-AB, easy-AC, easy-DA and easy-DC devices. Furthermore, you can use outputs that are not physically present as markers.

Relays	easy display	easy500	easy700	Coil function	Parameters
Analog value comparator function relays	A	A1...A16	A1...A16	–	✓
Counter function relays	C	C1...C16	C1...C16	✓	✓
Text marker function relays	D	D1...D16	D1...D16	✓	✓
7-day time switch function relays	Ø	Ø1...Ø4	Ø1...Ø4	–	✓
Markers (auxiliary relay)	M	M1...M16	M1...M16	✓	–
Markers (auxiliary relay)	N	N1...N16	N1...N16	✓	–
Operating hours counters	O	O1...O4	O1...O4	✓	✓
easy output relays	Q	Q1...Q8	Q1...Q8	✓	–
easy output relay expansion, auxiliary markers	S	S1...S8 (as marker)	S1...S8	✓	–
Timer function relays	T	T1...T16	T1...T16	✓	✓
Conditional jump	:	:1...:8	:1...:8	✓	–
Year time switch	Y	Y1...Y8	Y1...Y8	–	✓
Master reset, (central reset)	Z	Z1...Z3	Z1...Z3	✓	–

You can set the switching behaviour of these relays by means of the coil functions and parameters selected.

The options for setting output and marker relays are listed with the description of each coil function.

The coil functions and parameters are listed with the description of each function relay.

Circuit diagram display

In the easy circuit diagram, contacts and coils are connected up from left to right - from the contact to the coil. The circuit diagram is created on a hidden wiring grid containing contact fields, coil fields and rungs. It is then wired up with connections.

- You can add switch contacts in the three **contact fields**. Easy adds the first energized contact field automatically.
- You add the relay coil to be controlled together with its function and designation in the **coil field**.
- Every line in the circuit diagram forms a **rung**. Up to 128 rungs can be wired in a circuit diagram.

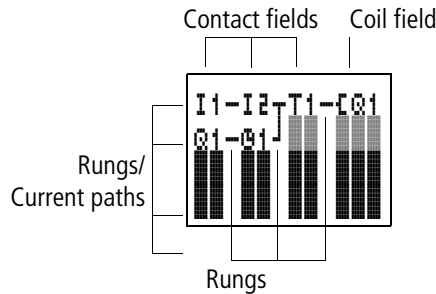

- **Connections** are used to produce the electrical contact between switch contacts and the coils. They can be created across several rungs. Each point of intersection is a connection.



The circuit diagram display performs two functions:

- In STOP mode it is used to edit the circuit diagram.
- In RUN mode it is used to check the circuit diagram using the Power flow display.

Saving and loading circuit diagrams

There are two ways of saving circuit diagrams in easy externally:

- By saving to a memory card
- By saving to a PC running EASY-SOFT-BASIC.

Once they have been saved, programs can be reloaded into easy, edited and run.

All circuit diagram data is saved in easy. In the event of a power failure the data will be retained until the next time it is overwritten or deleted.

Memory card

Each EASY-M-32K memory card contains a circuit diagram which is inserted into the easy interface. The program is stored retentively on the memory card.

The way the memory card works and a description of how to transfer a program to the card is given in section "Memory card" on page 248.



EASY-M-8K memory cards of easy400 devices can be read in easy500. EASY-M-8K memory cards of easy400 devices and easy600 EASY-M16K memory cards can be read in easy700.

Write operations from easy500 and easy700 are only possible to the EASY-M32K memory card.

EASY-SOFT-BASIC

EASY-SOFT-BASIC is a PC program with which you can create, store, test (simulate) and manage easy circuit diagrams.

Completed circuit diagrams are transferred between your PC and easy via the connecting cable. Once you have transferred a circuit diagram, simply run easy straight from your PC.

Details on the program and transferring circuit diagrams are given in section "EASY-SOFT-BASIC" from page 252.

Working with contacts and relays

In easy circuit diagrams, the switches, buttons and relays of conventional circuit diagrams are connected up using input contacts and relay coils.

Conventional circuit

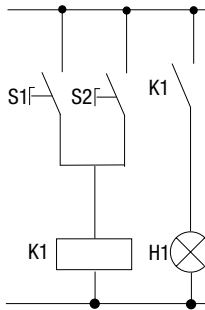

easy circuit diagram

easy terminal

- Connect make contact S1 to input terminal I2
- Connect make contact S2 to easy input terminal I3
- Connect load H1 to easy output Q4
- S1 or S2 switches on H1.

easy circuit diagram

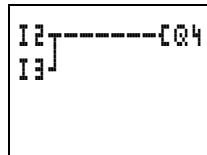

Input and output contacts

First specify which input and output terminals you wish to use in your circuit.

Depending on the type and configuration, easy has 8, 12 or 24 input terminals and 4, 6, 8, 10 or 16 outputs. The signal states on the input terminals are detected in the circuit diagram with the input contacts I1 to I12. R1 to R12 are the

input contacts of the expansion. In the circuit diagram the outputs are controlled via the corresponding output relay coils Q1 to Q8 or S1 to S8 (expansion).

Entering and changing contacts and relay coils

A switch contact is selected in easy via the contact name and contact number.

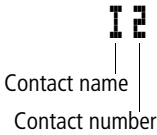

A relay coil is defined by its coil function, name and number.

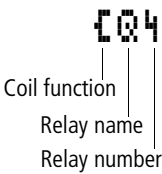

A full list of all the contacts and relays is given in the overview starting on page 78.



Values for contacts and coil fields are changed in Entry mode. The value to be changed flashes.



If the field is empty, easy will enter contact **I 1** or the coil **[Q 1]**.

- ▶ Move the cursor using the buttons < > ^ ∨ to a contact or coil field.
- ▶ Press **OK** to switch to Entry mode.
- ▶ Use < > to select the position you wish to change, or press **OK** to jump to the next position.
- ▶ Use ^ ∨ to modify the value of the position.

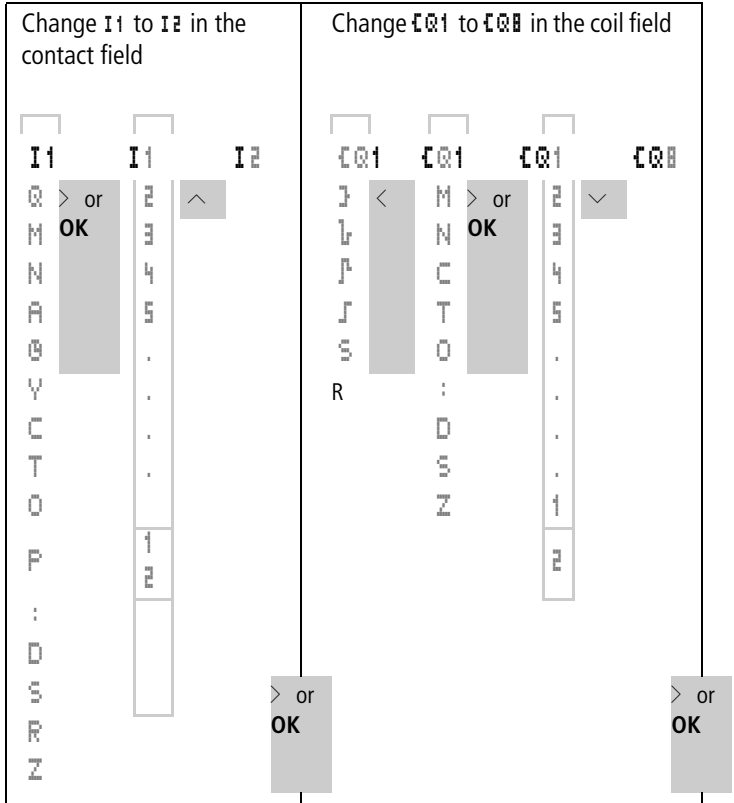

easy will leave Entry mode when you press < > or OK to leave a contact field or coil field.

Deleting contacts and relay coils

- ▶ Move the cursor using the buttons < > ^ v to a contact or coil field.
- ▶ Press DEL.

The contact or the relay coil will be deleted, together with any connections.

Changing make contacts to break contacts

Every switch contact in the easy circuit diagram can be defined as either a make contact or a break contact.

- ▶ Switch to Entry mode and move the cursor over the contact name.
- ▶ Press **ALT**. The make contact will change to a break contact.
- ▶ Press **OK** 2 × to confirm the change.

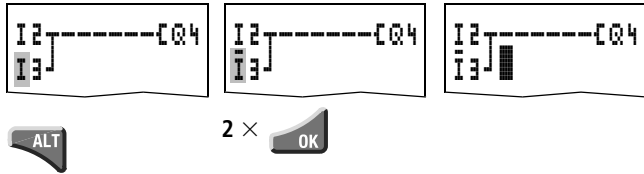

Figure 39: Changing contact I3 from make to break

Creating and modifying connections

Switch contacts and relay coils are connected with the wiring arrow in Connect mode. easy displays the cursor in this mode as an arrow.

- ▶ Use < > ^ v to move the cursor onto the contact field or coil field from which you wish to create a connection.



Do not position the cursor on the first contact field. At this position the **ALT** button has a different function (Insert rung).

- ▶ Press **ALT** to switch to Connect mode.
- ▶ Use < > to move the diagonal arrow between the contact fields and coil fields and ^ v to move between rungs.
- ▶ Press **ALT** to leave Connect mode.

easy will leave the mode automatically when you move the diagonal arrow onto a contact field or coil field which has already been assigned.



In a rung, easy automatically connects switch contacts and the connection to the relay coil if there are no empty fields in-between.

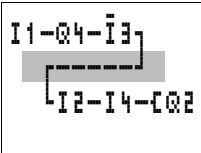

Never work backwards. You will learn why wiring backwards does not work in section "Example: Do not wire backwards" from page 237.

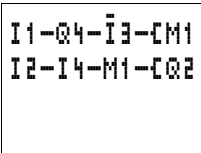

When wiring more than three contacts in series, use an M or N marker.

Deleting connections

- ▶ Move the cursor onto the contact field or coil field to the right of the connection that you want to delete. Press **ALT** to switch to Connect mode.
- ▶ Press **DEL**.

easy will delete a connection. Closed adjacent connections will be retained.

If several rungs are connected to one another, easy first deletes the vertical connection. If you press **DEL** again, it will delete the horizontal connection as well.



You cannot delete connections that easy has created automatically.

Close the delete operation with **ALT** or by moving the cursor to a contact or coil field.

Inserting and deleting a rung

The easy circuit diagram shows four of the 128 rungs in the display at the same time. If you move the cursor past the top or bottom of the display, easy automatically scrolls up or down the display to show hidden rungs – even empty ones.

A new rung is added below the last connection or inserted above the cursor position:

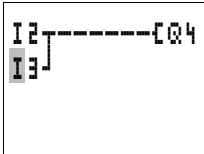

- ▶ Position the cursor on the **first** contact field of an empty rung.
- ▶ Press **ALT**.

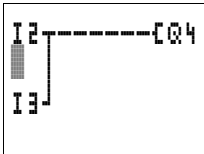

The existing rung with all its additional connections is “shifted” downwards. The cursor is then positioned directly in the new rung.

Deleting a rung

easy will only remove empty rungs, i.e. those without contacts or coils.

- ▶ Delete all the contacts and relay coils from the rung.
- ▶ Position the cursor on the first contact field of the empty rung.
- ▶ Press **DEL**.

The subsequent rung(s) will be “pulled up” and any existing links between rungs will be retained.

Switching with the cursor buttons

With easy, you can also use the four cursor buttons as hard-wired inputs in the circuit diagram.

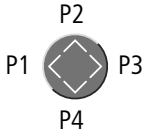

The buttons are wired in the circuit diagram as contacts P1 to P4. The P buttons can be activated and deactivated in the System menu.

The P buttons can also be used for testing circuits or manual operation. These button functions are also useful for servicing and commissioning purposes.

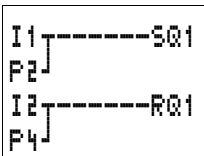

Example 1:

A lamp at output relay Q1 is switched on and off via inputs I1 and I2 or using cursor buttons \wedge \vee .

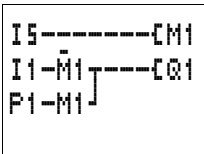

Example 2

Terminal I1 is used to control output relay Q1. Terminal I5 switches to Cursor button mode and deactivates rung I1 via $\overline{M1}$.



The P buttons are only detected as switches in the Status menu. The cursor buttons are used for other functions in the menus, the power flow display and in the text display.

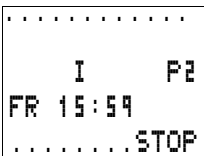

The Status menu display shows whether the P buttons are used in the circuit diagram.

- P: button function wired and active.
- P2: button function wired, active and P2 button \wedge pressed.
- P-: button function wired and not active.
- Empty field: P buttons not used.

Checking the circuit diagram

easy contains a built-in measuring device enabling you to monitor the switching states of contacts and relay coils during operation.

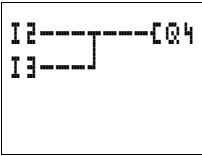

- ▶ Complete the small parallel connection and switch easy to RUN mode via the main menu.
- ▶ Return to the circuit diagram display.

You are now unable to edit the circuit diagram.



If you switch to the circuit diagram display and are unable to modify a circuit diagram, first check whether easy is in STOP mode.

The circuit diagram display performs two functions depending on the mode:

- STOP: Creation of the circuit diagram
- RUN: Power flow display

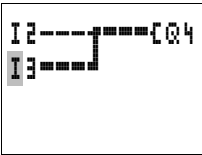

- ▶ Switch on I3.

In the power flow display, energized connections are thicker than non-energized connections.

You can follow energized connections across all rungs by scrolling the display up and down.







The power flow display will not show signal fluctuations in the millisecond range. This is due to the inherent delay factor of LCD displays.

Coil functions

You can set the coil function to determine the switching behaviour of relay coils. The following coil functions are available for relays Q, M, S, D, “:”:

Table 8: Coil function

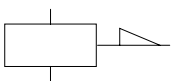
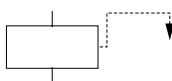
Circuit diagram symbol	easy display	Coil function	Example
	C	Contactor function	C01, C02, C54, C:1, CM1
	∩	Contactor function with negated result	∩01, ∩02, ∩54
	↳	Cycle pulse with falling edge	↳03, ↳M4, ↳D0, ↳S1
	↗	Cycle pulse with rising edge	↗04, ↗M5, ↗D1, ↗S3
	∫	Impulse relay function	∫03, ∫M4, ∫D0, ∫S1
	S	Set (latching)	S00, SM2, SD3, SS4
	R	Reset (unlatching)	R04, RM5, RD1, RS3

Marker relays M and N are used as a flag. The S relay can be used as the output of an expansion unit or as a marker if no expansion unit is connected. The only difference between them and the output relay Q is that they have no output terminals.



The coil functions of the function relays are described in the descriptions for the appropriate relays.



The coil functions **C**, **N**, **L**, **P**, (contactor, contactor negated, cycle pulse negative, rising edge) must only be used once for each relay coil. The last coil in the circuit diagram determines the status of the relay.

When controlling a contactor or relay, the control coil is only present once. If you are creating parallel circuits, use Set, Reset as a coil function.

Rules for wiring relay coils

To ensure a clear overview of all relay states only assign the same coil function once to a relay (**J**, **S**, **R**). However, retentive coil functions such as **J**, **S**, **R** can be used several times if required by the circuit diagram logic.

Exception: When using jumps to structure a circuit diagram, this coil function can also be used effectively several times.

Relay with contactor function C

The output signal follows immediately after the input signal and the relay acts as a contactor.

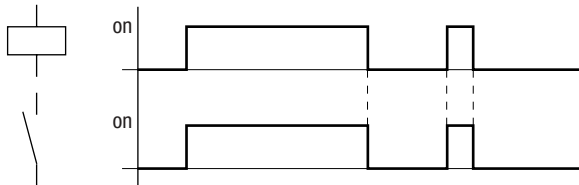

Figure 40: Signal diagram of contactor function

Representation in easy:

- Output relays Q: **Q01** to **Q08** (depending on type)
- Markers M, N: **M1** to **M16**, **N1** to **N16**
- Function relays (Text) D: **D1** to **D16**
- Output relays S: **S1** to **S8**
- Jumps: **C:1** to **C:8**

Contactor function with negated result (inverse contactor function)]



The output signal is simply an inversion of the input signal; the relay operates like a contactor with contacts that have been negated. If the coil is triggered with the 1 state, the coil switches its make contacts to the 0 state.

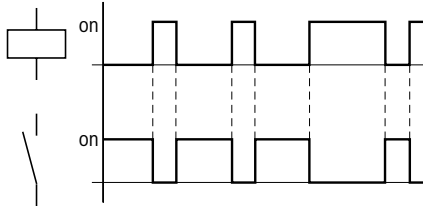

Figure 41: Signal diagram of inverse contactor function

Representation in easy

- Output relays Q:]Q1 to]Q8 (depending on type)
- Markers M, N:]M1 to]M16,]N1 to]N16
- Function relays (Text) D:]D1 to]D16
- Output relays S:]S1 to]S8
- Jumps:]:1 to]:8

Falling edge evaluation (cycle pulse)]



This function is used if the coil is only meant to switch on a falling edge. With a change in the coil state from 1 to 0, the coil switches its make contacts to the 1 state for one cycle.

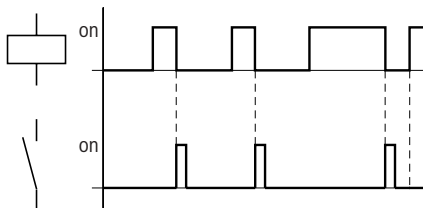

Figure 42: Signal diagram of cycle pulse with falling edge

Representation in easy:

- Markers M, N: $\overline{L}M1$ to $\overline{L}M1$, $\overline{L}N1$ to $\overline{L}N1$
- Jumps: $\overline{L} : 1$ to $\overline{L} : 1$



Physical outputs should not be used as a cycle pulse is generated.



Rising edge evaluation (cycle pulse)

This function is used if the coil is only meant to switch on a rising edge. With a change in the coil state from 0 to 1, the coil switches its make contacts to the 1 state for one cycle.

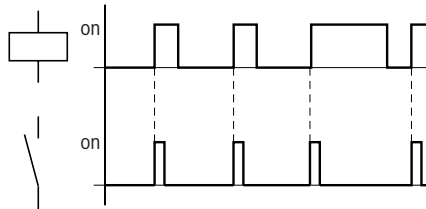

Figure 43: Signal diagram of cycle pulse with rising edge

Representation in easy:

- Markers M, N: $\overline{L}M1$ to $\overline{L}M1$, $\overline{L}N1$ to $\overline{L}N1$
- Jumps: $\overline{L} : 1$ to $\overline{L} : 1$



Physical outputs should not be used as a cycle pulse is generated.

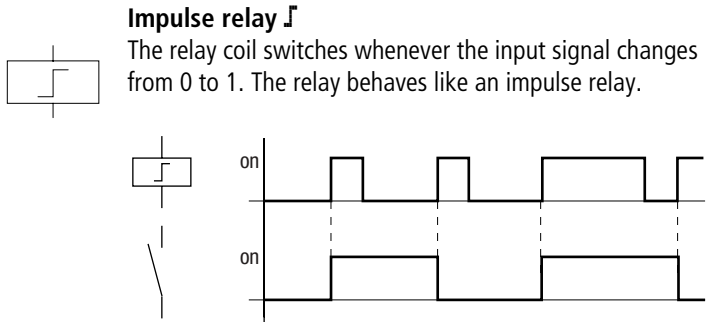

Figure 44: Signal diagram of impulse relay

Representation in easy:

- Output relays Q: $Q01$ to $Q08$ (depending on type)
- Markers M: $M1$ to $M16$
- Function relays (Text) D: $D1$ to $D8$
- Relays S: $S1$ to $S8$



A coil is automatically switched off if the power fails and if STOP mode is active. Exception: Retentive coils retain signal 1 (→ section "Retention (non-volatile data storage)" from page 230).

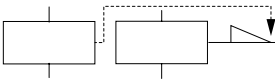

Latching relay

The “latch” and “unlatch” relay functions are used in pairs. The relay picks up when latched and remains in this state until it is reset by the “unlatch” function.

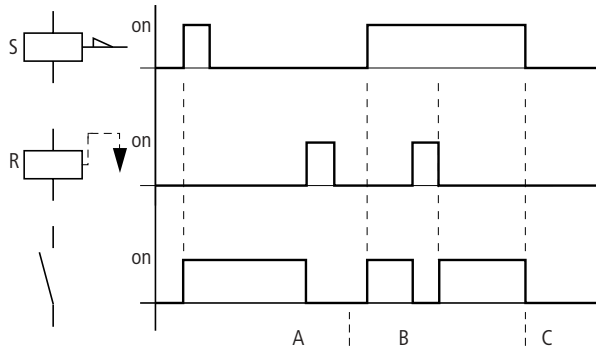

Figure 45: Latching relay signal diagram

- Range A: The Set coil and the Reset coil are triggered at different times
- Range B: Reset coil is triggered at the same time as the Set coil
- Range C: Power supply switched off

Representation in easy:

- Q output relays: **SQ1** to **SQ8**, **RQ1** to **RQ8** (depending on type)
- M markers: **SM1** to **SM16**, **RM1** to **RM16**
- (Text) D function relays: **SD1** to **SD8**, **RD1** to **RD8**
- S relays: **SS1** to **SS8**, **RS1** to **RS8**

Use each of the two relay functions **S** and **R** once only per relay.

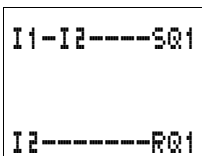

If both coils are triggered at the same time, priority is given to the coil further down in the circuit diagram. This is shown in the above signal diagram in section B.



A latched relay is automatically switched off if the power fails or if the device is in STOP mode. Exception: Retentive coils retain signal 1 (→ section "Retention (non-volatile data storage)", page 230).

Function relays

Function relays allow you to simulate the functions of different conventional control engineering devices in your circuit diagram. easy provides the following function relays:

Table 9: Function relays

easy circuit diagram symbol	Function relays
A1, A2	Analog value comparator, threshold value switch (only useful for devices with an analog input)
C1, CC1, DC1, RC1	Counter relay, up/down counter, high-speed counter, frequency counter
DE, CE	Text, output user-defined texts, enter values
Ø1, Ø2	Time switch, weekday/time
O1, CO2	Operating hours counter with limit value entry.
T1, TT1, RT1, HT1 X, ?X	Timing relay, on-delayed Timing relay, on-delayed with random switching
T1, TT1, RT1, HT1 ■, ?■	Timing relay, off-delayed Timing relay, off-delayed with random switching
T6, TT6, RT6, HT6 X■, ?X■	Timing relay, on/off-delayed Timing relay, on/off delayed with random switching
T2, TT2, RT2, HT2 ∧	Timing relay, single pulse

easy circuit diagram symbol	Function relays
T \exists , TT \exists , RT \exists , HT \exists ⏏	Timing relay, flashing
: \exists , E: \exists	Jump
Y \exists	Year time switch, date
Z1, Z \exists	Master reset, central reset of outputs, markers

A function relay is started via its relay coil or by evaluating a parameter. It switches the contact of the function relay according to its function and the set parameters.



Current actual values are cleared if the power supply is switched off or if easy is switched to STOP mode.

Exception: Retentive coils keep their logic state (→ section "Retention (non-volatile data storage)", page 230).



Attention!

The following applies to RUN mode: easy processes the function relays after a pass through the circuit diagram. The last state of the coils is used for this.

Only use the coil of a function relay once. Exception: When working with jumps, the same coil can be used several times.

Example with function relay timer and counter relay

A warning light flashes when the counter reaches 10. The example shows function relays C1 and T1. The S1 pushbutton actuator is used for the count signal. The S2 pushbutton actuator resets counter P1.

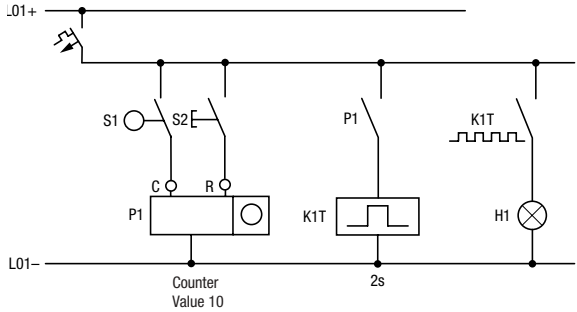

Figure 46: Hardwiring with relays

I5	-----	CC1
I6	-----	RC1
C1	-----	TT1
T1	-----	EQ1

The wiring of the easy relay looks as follows.

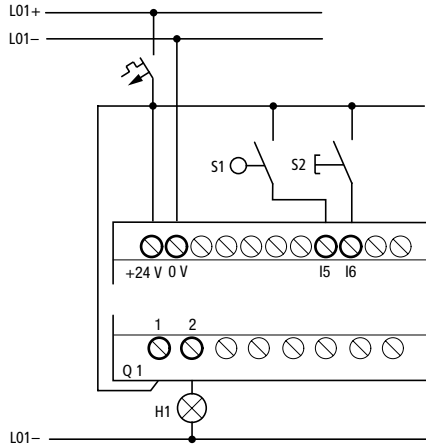
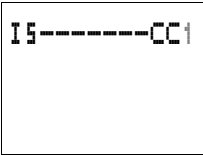

Figure 47: easy wiring and circuit diagram

The counter P1 is called C1 in easy.

The timing relay K1T is called T1 in easy.



▶ Complete the circuit diagram up to **CC1**.

CC1 is the count coil of the counter 1 function relay.



Press **OK** to call up the easy parameter display.

▶ Move the cursor onto the **1** of **CC1** and press **OK**.

The parameter set for the counter is displayed.

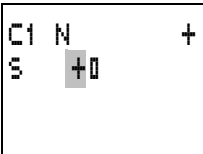

▶ Press the cursor button until the cursor is on the plus sign on the right of the **S** (setpoint).

▶ Press the **OK** button.

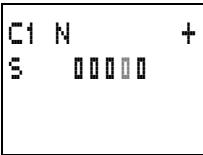

▶ Press the **>** button.

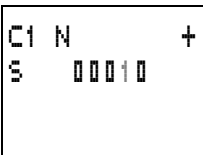

▶ Use **>** to move the cursor onto the tens digit.

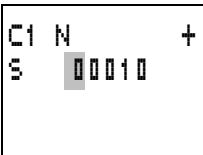

▶ Use **^** **∨** to modify the value of the digit.

▶ Confirm the value input with **OK**.

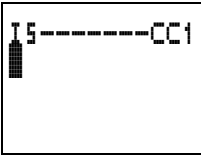

- ▶ Press **ESC** to return to the circuit diagram, the setpoint 0010 will be stored.



easy has specific parameter displays for function relays. The meaning of these parameters is explained under each relay type.

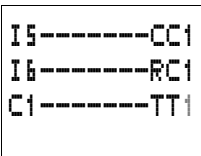

- ▶ Enter the circuit diagram up to coil **TT1** of the timing relay. Set the parameter for **T1**.

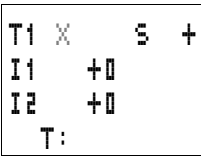

The timing relay works like a flashing relay. The easy symbol for the flasher/blink relay is \perp . It is set at the top left of the parameter display. **S** means here the Seconds time base.

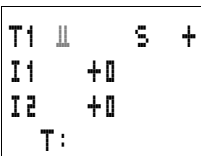

- ▶ Select the \perp symbol by pressing the \vee button.

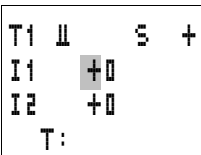

- ▶ Use the \gt button to move to the first time setpoint **I1**.

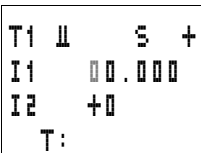

- ▶ Press the **OK** button.
- ▶ Press the \gt button.

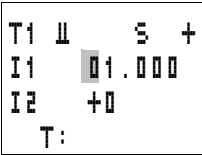

- ▶ Use the ^ < > buttons to enter the value 01.000.
- ▶ Confirm with **OK**.

The time setpoint I1 for the pause time is 1 s

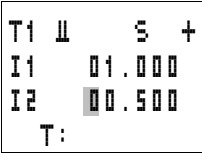

- ▶ Use the v button to enter the value of the second setpoint I2.
- ▶ Set this value to 0.5 s.

This is the time value for the pulse time.

- ▶ Press **ESC** to leave the parameter entry.

The values are now stored.

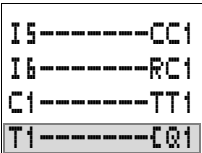

- ▶ Complete the circuit diagram.



- ▶ Press the **ESC** button.
- ▶ Press **OK** to store the circuit diagram.
- ▶ Test the circuit diagram using the power flow display.
- ▶ Switch easy to RUN mode and return to the circuit diagram.

Each parameter set can be displayed using the power flow display for the circuit diagram.

- ▶ Move the cursor onto C1 and press **OK**.

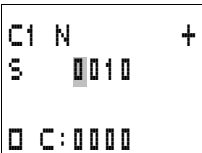

The parameter set for the counter is displayed with actual and setpoint values.

- ▶ Switch the input I5. The actual value changes.

```

C1 N      +
S   0010

□ C:0007

```

This is represented in the easy parameter display. In the last line **C: 0007** the counter actual value is = 7.

```

C1 N      +
S   0010

■ C:0010

```

If the actual value is greater than or equal to the setpoint (10), the left character on the bottom row will change to **■**. The contact of counter **C1** switches.

The counter contact triggers the timing relay. This causes the warning light to flash at output Q1.

```

I5-----CC1
I6-----RC1
C1=====TT1
T1=====Q1

```

Power flow of the circuit diagram

```

T1  11  S  +
S1   00.500
S2   00.250
■ T:00.200

```

Doubling the flashing frequency:

- ▶ In the power flow display select **T1**.
- ▶ Press **OK**.
- ▶ Change the set time **I1** to **00.500** and **I2** to **00.250** (0.5 and 0.25 s).
- ▶ The set time will be accepted as soon as you press **OK**.

The character on the left of the bottom row will indicate whether the contact has switched or not.

- □ Contact has not switched (make contact open).
- ■ Contact has switched (make contact closed).

You can also modify parameter settings via the **PARAMETER** menu option.



If you want to prevent other people from modifying the parameters, change the access enable symbol from + to – when creating the circuit diagram and setting parameters. You can then protect the circuit diagram with a password.

**Analog value comparator/
threshold value switch**

easy provides 16 analog comparators A1 to A16 for use as required. These can also be used as threshold value switches or comparators.

An analog value comparator or threshold value switch enables you to compare analog input values with a setpoint, the actual value of another function relay or another analog input. This enables you to implement small controller tasks such as two-point controllers very easily.

All easy-AB, easy-DA and easy-DC devices are provided with analog inputs.

- The analog inputs of the easy500 are I7 and I8.
- The analog inputs of the easy700 are I7, I8, I11 and I12



Compatibility with easy400 and easy600

If you have loaded an existing easy400 or easy600 circuit diagram, the previous comparator functions and values are retained. The analog value comparator function relay can work in easy500 and easy700 in the same way as in easy400, easy600. The setpoints are converted to the new resolution of the analog inputs. The setpoint 5.0 (easy400, easy600) is converted to the setpoint 512 (easy500, easy700).

The following comparisons are possible:

Value at function relay input I1	Comparator functions		Value at function relay value input I2
		Mode selection at the function relay	
Analog input I7, I8, I11, I12			Analog input I7, I8, I11, I12
Setpoint 0000 to 9999			Setpoint 0000 to 9999
Actual value of counter relays C1 to C16			Actual value of counter relay C1 to C16

Value at function relay input I1	Comparator functions		Value at function relay value input I2
		Mode selection at the function relay	
Actual value of timing relay T1 to T16			Actual value of timing relay T1 to T16
	Less than	LT	
	Less than/equal to	LE	
	Equal to	EQ	
	Greater than/equal to	GE	
	Greater than	GT	

Table 10: Comparison examples:

A1 function relay Value input I1		A1 function relay Value input I2
I7	GE (greater than/equal to)	I8
I7	LE (less than/equal to)	I8
I7	GE (greater than/equal to)	Setpoint
I7	LE (less than/equal to)	Setpoint
I8	GE (greater than/equal to)	Setpoint
I8	LE (less than/equal to)	Setpoint

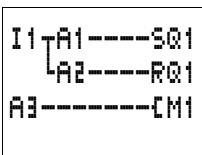

Circuit diagram display with analog value comparator

Analog value comparators are integrated as contacts in the circuit diagram.

In the circuit diagram above, I1 enables both analog value comparators. If a value goes below the set value, A1 switches output Q1. If another value exceeds the set value, A2 deactivates output Q1. A3 switches marker M1 on and off.

A1	EQ	+
I1	+0	+
F1	+0	
I2	+0	+
F2	+0	
OS	+0	
HY	+0	

Table 11: Parameter display and parameter set for analog value comparator:

A1	Analog value comparator function relay 1
EQ	Equal mode The function relay has the following modes: <ul style="list-style-type: none"> • LT: less than • LE: less than/equal to • EQ: equal to • GE: great than/equal to • GT: greater than
+	+ appears in the PARAMETER menu. - does not appear in the PARAMETER menu.
I1	Comparison value 1 (positive value I7, I8, I11, I12, actual value T1 to T16, C1 to C16)
F1	Gain factor for I1 ($I1 = F1 \times \text{actual value at I1}$); F1 = positive value from 0 to 9999
I2	Comparison value 2 (positive value I7, I8, I11, I12, actual value T1 to T16, C1 to C16)
F2	Gain factor for I2 ($I2 = F2 \times \text{actual value at I2}$); F2 = positive value from 0 to 9999
OS	Offset for the value of I1 ($I1 = OS + \text{actual value at I1}$); OS = positive value from 0 to 9999
HY	Switching hysteresis for value I2 Value HY applies both to positive and negative hysteresis. <ul style="list-style-type: none"> • $I2 = \text{Actual value at I2} + HY$; • $I2 = \text{Actual value at I2} - HY$; • HY = positive value from 0 to 9999



Work normally with analog inputs and setpoints as the parameters for the analog value comparator.

Compatibility between easy400 and easy500, easy600 and easy700

New functions have been added to the parameter display of easy500 and easy700. The easy400 and easy600 parameters can be found at the following points.

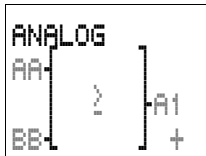

easy400, easy600
parameters

AA
BB
A1
+
>

= I1 AA
= I2 BB
= A1
= +
= GE

easy500, easy700
parameters

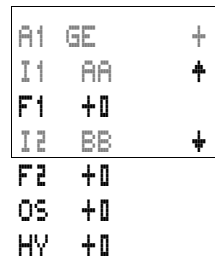

The analog value comparator for easy500 and easy700 operates internally in the value range:

-2 147 483 648 to +2 147 483 647

This ensures that the correct value is always calculated. This is important for multiplying values ($I1 \times F1$ or $I2 \times F2$).

Example:

$I1 = 9999$, $F1 = 9999$

$I1 \times F1 = 99980001$

The result is within the value range.



If no value is entered at F1 or F2, only the value at I1 and I2 is used (no multiplication).



If the value of a control relay exceeds the value 9999, the value of the counter is shown in the display of the analog value comparator minus 10000.

Example: Counter actual value = 10233

Display of the analog value comparator: 233 (10000 is displayed as 0).

Parameter display in RUN mode

Parameter display and parameter set for analog value comparator in RUN mode with the display of the actual values:

A1	EQ	+	
I1	0249	+	— Actual value, e.g.: analog input
F1	0000		— Factor is not used
I2	0350	+	— Actual comparison value, e.g.: constant
F2	0000		— Factor is not used
OS	0000		— Offset is not used
HV	0025		— The switching hysteresis is +/- 25

Resolution of the analog inputs

The analog inputs I7, I8, and on the easy700 I11, I12 have the following resolution.

The analog signal from 0 to 10 V DC is converted to a 10-bit digital value from 0 to 1 023. A digital value of 100 represents an analog value of 1.0 V (exactly 0.98 V).

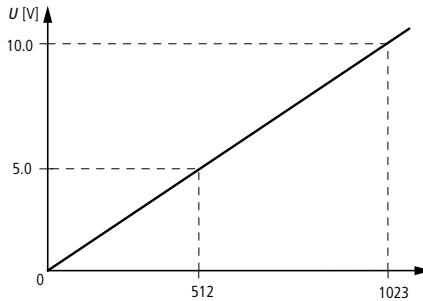

Figure 48: Resolution of the analog inputs

Function of the analog value comparator



The GT, GE, LT, and LE comparison functions only differ in the fact that GE and LE also switch when the value is equal to the setpoint. easy500 and easy700 feature five comparison modes so that all analog value comparators from easy400 to easy800 are compatible.



Caution!

Analog signals are more sensitive to interference than digital signals. Consequently, more care must be taken when laying and connecting the signal lines.

Set the switching hysteresis to a value so that interference signals will not cause accidental switching. A value of 0.2 V (value 20 without gain) must be observed as a safety value.

Function of the Less than comparison

Parameter display and parameter set for Less than analog value comparator.

A1	LT	+
I1	I1	+
F1	+0	
I2	0100	+
F2	+0	
OS	+0	
HV	0025	

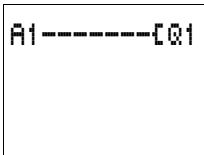

Circuit diagram with analog value comparator.



The values **F1 +0**, **F2 +0** and **OS +0** were not defined. A gain is not used with any values. No offset is used.

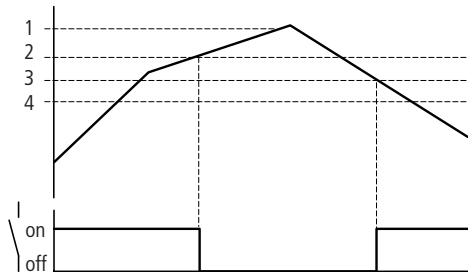

Figure 49: Signal diagram of analog value comparator in Less than mode

- 1: actual value at I7
- 2: setpoint plus hysteresis value
- 3: setpoint
- 4: setpoint minus hysteresis

The make contact switches off when the actual value at I7 exceeds the setpoint plus hysteresis. If the actual value at I7 falls below the setpoint, the make contact switches on.

Function of the Less than/equal to comparison

Parameter display and parameter set for Less than and equal to analog value comparator.

A2	LE	+
I1	I7	+
F1	+0	
I2	0100	+
F2	+0	
OS	+0	
HV	0025	

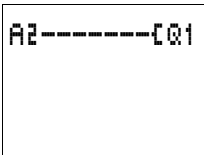

Circuit diagram with analog value comparator.



The values **F1 +0**, **F2 +0** and **OS +0** were not defined. No values are used with a gain factor, and no offset is used.

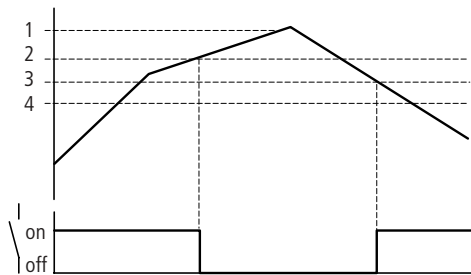

Figure 50: Signal diagram of analog value comparator in Less than/equal to mode

- 1: actual value at I7
- 2: setpoint plus hysteresis value
- 3: setpoint
- 4: setpoint minus hysteresis

The make contact switches off when the actual value at I7 exceeds the setpoint plus hysteresis. If the actual value at I7 equals or falls below the setpoint, the make contact switches on.

Function of the Equal to comparison

Parameter display and parameter set for Equal analog value comparator.

AB	E0	+
I1	I8	+
F1	0010	
I2	3000	+
F2	+0	
OS	+0	
HY	0250	

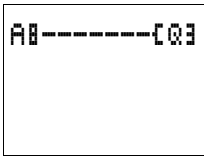

Circuit diagram with analog value comparator.



The values **F2 +0** and **OS +0** were not defined. No values are used with a gain factor, and no offset is used. A gain factor of 10 is used with the analog value at I8. The hysteresis is adjusted accordingly.

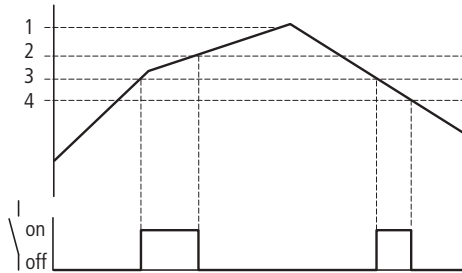

Figure 51: Signal diagram of analog value comparator in Equal to mode

- 1: actual value at I8, multiplied with gain factor F2
- 2: setpoint plus hysteresis value
- 3: setpoint
- 4: setpoint minus hysteresis

The make contact switches on if the actual value at I8 (multiplied by F1) reaches the configured setpoint. If the value exceeds the setpoint plus hysteresis, the make contact switches off. If the

actual value at I8 (multiplied by F1) falls to the setpoint, the make contact switches on. If the actual value falls below the setpoint minus hysteresis, the make contact switches off.

Example: Function of the Greater than/equal to comparison

Parameter display and parameter set for Greater than/equal to analog value comparator.

AS	GE	+
I1	I7	+
F1	+0	
I2	0100	+
F2	+0	
OS	+0	

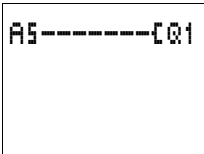

Circuit diagram with analog value comparator.



The values F1 +0, F2 +0 and OS +0 were not defined. No values are used with a gain factor, and no offset is used.

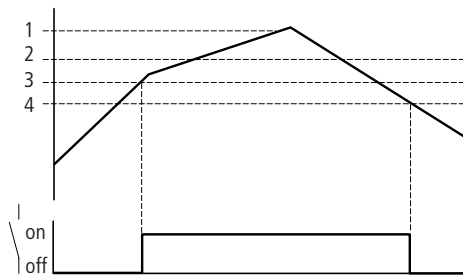

Figure 52: Signal diagram of analog value comparator in Greater than/equal to mode

- 1: actual value at I7
- 2: setpoint plus hysteresis value
- 3: setpoint
- 4: setpoint minus hysteresis

The make contact switches if the actual value at I7 is equal to the setpoint. The make contact switches off when the actual value at I7 falls below the setpoint minus hysteresis.

Example: Function of the Greater than comparison

Parameter display and parameter set for Greater than analog value comparator.

A4	GT	+
I1	I7	+
F1	+0	
I2	0100	+
F2	+0	
OS	+0	
HV	0025	

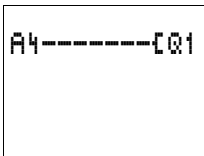

Circuit diagram with analog value comparator.



The values **F1 +0**, **F2 +0** and **OS +0** were not defined. No values are used with a gain factor, and no offset is used.

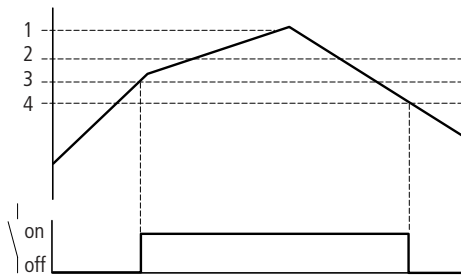
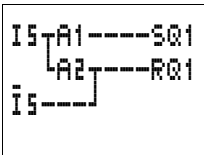

Figure 53: Signal diagram of analog value comparator in Greater than mode

- 1: actual value at I7
- 2: setpoint plus hysteresis value
- 3: setpoint
- 4: setpoint minus hysteresis

The make contact switches if the actual value at I7 reaches the setpoint. The make contact switches off when the actual value at I7 falls below the setpoint minus hysteresis.

Example: Analog value comparator as two-step controller



If, for example, the temperature goes below a value, A1 switches on the output Q1 with the enable input I5. If the temperature exceeds the set value, A2 will switch off. If there is no enable signal, output Q1 will always be switched off by I5.

Parameter settings of both analog value comparators:

Switching on

A1	LT	+
I1	I7	+
F1	+0	
I2	0500	+
F2	+0	
OS	+0	
HV	+0	

Switch off

A2	GT	+
I1	I7	+
F1	+0	
I2	0550	+
F2	+0	
OS	+0	
HV	0015	

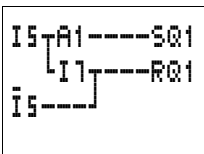

A simple circuit can be implemented if a switching point of the controller is assigned to the digital switching point of the analog input. This switching point has a 8 V DC (easy-DA, easy-DC) and 9.5 V (easy-AB) signal.

Parameter settings:

Switching on

A1	LT	+
I1	I7	+
F1	+0	
I2	0500	+
F2	+0	
OS	+0	
HV	+0	

Switch off

The switch point is implemented via I7 (digital switching signal).

Example: analog value comparator, detection of operating states

Several analog value comparators can be used to evaluate different operating states. In this case 3 different operating states are evaluated.

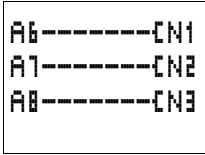

Parameter settings of three analog value comparators:

First operating state

A6	EQ	+
I1	I7	+
F1	+0	
I2	0500	+
F2	+0	
OS	+0	
HV	0025	

Second operating state

A7	EQ	+
I1	I7	+
F1	+0	
I2	0700	+
F2	+0	
OS	+0	
HV	0025	

Third operating state

A8	EQ	+
I1	I7	+
F1	+0	
I2	0850	+
F2	+0	
OS	+0	
HV	0025	

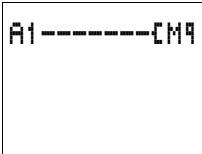

Example: analog value comparator, comparison of two analog values

To compare two analog values, you can use the following circuit. In this case, the comparison determines whether I7 is less than I8.

A1	LT	+
I1	I7	+
F1	+0	
I2	I8	+
F2	+0	
OS	+0	
HV	0025	

Parameter settings of the analog value comparator

Counters

easy provides 16 up/down counters C1 to C16 for use as required. The counter relays allow you to count events. You can define an upper threshold value as a comparison value. The contact will switch according to the actual value.

High-speed counters, frequency counters up to 1 kHz counter frequency.

easy-DA and easy-DC feature four high-speed counters C13 to C16. The function is defined by the mode selected. The counter input is connected directly to a digital input. The high-speed digital inputs are I1 to I4.

Possible applications include the counting of components, lengths, events and frequency measurement.



The counters of easy500 and easy 700 function in the same way as the counters of easy400 and easy600. If required, the same counters can also be used for retentive data.

Table 12: Counter modes

Counters	Mode	
C1 to C12	N	Up/down counters
C13, C14	N or H	Up/down counters or high-speed up counters (easy-DA, easy-DC)
C15, C16	N or F	Up/down counters or frequency counters (easy-DA, easy-DC)

Wiring of a counter

You integrate a counter into your circuit in the form of a contact and coil. The counter relay has different coils.



To prevent unpredictable switching states, use each coil of a relay once only in the circuit diagram.

Do not use the input of a high-speed counter as a contact in the circuit diagram. If the counter frequency is too high only a random input value will be used in the circuit diagram.

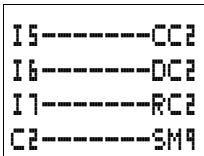

easy circuit diagram with counter relay

The coils and contacts have the following meanings:

Contact	Coil	
C1 to C16		The contact switches if the actual value is greater than or equal to the setpoint.

Contact	Coil	
	CC1 to CC16	Counter input, rising edge counts
	DC1 to DC16	Counting direction <ul style="list-style-type: none"> • Coil not triggered: up counting. • Coil triggered: down counting.
	RC1 to RC16	Reset, coil triggered: actual value reset to 00000

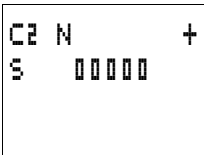

Parameter display and parameter set for the counter relay:

C2	Counter function relay number 2
N	<ul style="list-style-type: none"> • Mode N: up/down counter • Mode H: high-speed up/down counter. • Mode F: frequency counter
+	<ul style="list-style-type: none"> • + appears in the PARAMETER menu. • - does not appear in the PARAMETER menu.
S	Setpoint, constant from 00000 to 32000

In the parameter display of a counter relay you change the mode, the setpoint and the enable of the parameter display.

Compatibility between the easy400 and easy500, easy600 and easy700 counter parameter displays

New functions have been added to the parameter display of easy500 and easy700. The easy400 and easy600 parameters can be found at the following points.

<pre> [AAAA] C DIR C CNT } C1 C RES } + </pre>	<p>easy400, easy600 parameters</p> <p>AAAA</p> <p>C1</p> <p>+</p>	<p>=</p> <p>=</p> <p>=</p> <p>=</p>	<p>easy500, easy700 parameters</p> <pre> C1 N + S AAAAA </pre>
---	---	-------------------------------------	--

Value range

The counter relay counts between 0 and 32 000.

Behaviour when value range is reached

The easy control relay is in RUN mode.

If the value of 32 000 is reached, this value will be retained until the count direction is changed. If the value of 00000 is reached, this value will be retained until the count direction is changed.

Parameter display in RUN mode:

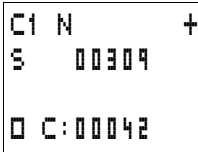

— Current setpoint, constant (0309)

— Contact has not switched.

Contact has switched.

Actual value (00042)

Retention

Counter relays can be operated with retentive actual values. You can select the retentive counter relays in the SYSTEM... → RETENTION... menu. C5 to C7, C8 and C13 to C16 can be selected.

If a counter relay is retentive, the actual value is retained when the operating mode changes from RUN to STOP as well as when the power supply is switched off.

When easy is restarted in RUN mode, the counter relay continues with the retentively stored actual value.

Determining counter frequency

The maximum counter frequency depends on the length of the circuit diagram in easy. The number of contacts, coils and rungs used determines the run time (cycle time) required to process the easy circuit diagram.

Example: When using EASY512-DC-TC with only three rungs for counting, resetting and outputting the result via the output, the counter frequency may be 100 Hz.

The maximum counter frequency depends on the maximum cycle time.

The following formula is used to determine the maximum counter frequency:

$$f_c = \frac{1}{2 \times t_c} \times 0.8$$

f_c = maximum counter frequency

t_c = maximum cycle time

0.8 = Correction factor

Example

The maximum cycle time is $t_c = 4000 \mu\text{s}$ (4 ms).

$$f_c = \frac{1}{2 \times 4 \text{ ms}} \times 0.8 = 100 \text{ Hz}$$

Function of the counter function relay

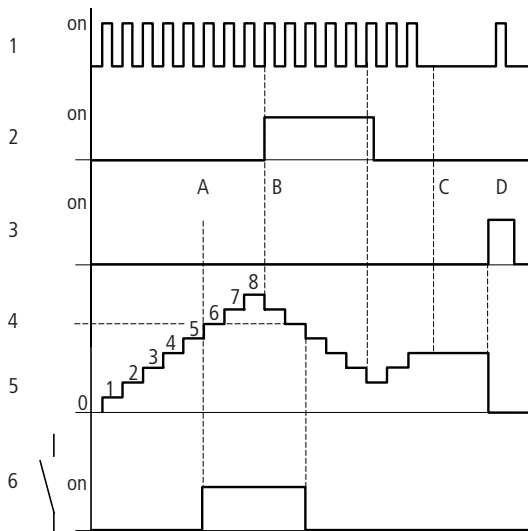

Figure 54: Signal diagram

1: Count pulses at the count coil CC...

- 2: Count direction, direction coil DC...
- 3: Reset signal at the reset coil RC...
- 4: Counter setpoint (the setpoint in the figure = 6)
- 5: actual value of the counter
- 6: contact of the counter, C

- Range A: The relay contact of counter C with setpoint value 6 switches when the actual value is 6.
- Range B: If the counting direction is reversed B, the contact is reset when the actual value is 5.
- Range C: Without count pulses the current actual value is retained.
- Range D: The reset coil resets the counter to 0.

Example: counters, counting unit quantities, manual counter value reset

The input I6 contains the necessary counter information and controls the count coil CC1 of counter 1. Q4 is activated if the setpoint is reached. Q4 remains switched on until I7 resets counter C1 to zero with the RC1 coil.

Circuit diagram display

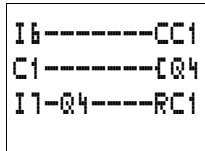

Parameter settings of the C1 counter

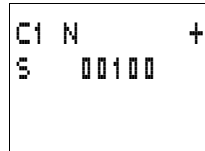

Example: counting unit quantities, automatic counter value reset

The input I6 contains the necessary counter information and controls the count coil CC2 of counter 2. M8 will be switched on for one program cycle if the setpoint is reached. The counter C2 is automatically set to zero by the Reset coil RC2.

Circuit diagram display

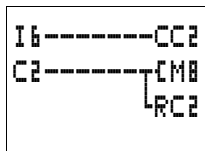

Parameter settings of the C2 counter

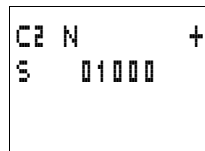

Example of a two counter cascade

Another counter is added to the previous example. As the contact of counter C2 is only set to 1 for one program cycle, the carry of counter C2 is transferred to counter C3. The counter C3 prevents further counting when its setpoint is reached.

Circuit diagram display

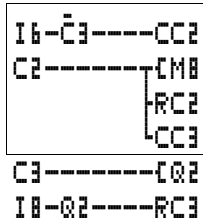

Parameter settings of the
C2 counter

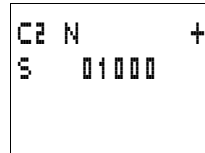

Parameter settings of the
C3 counter

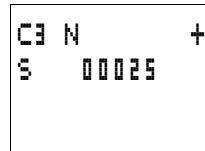

25000 pulses are
counted.
 $25 \times 1000 = 25000$

Example: up/down counting with a scan for actual value = zero

The input I6 contains the necessary counter information and controls the count coil CC6 of counter 6. Marker N2 is set if the setpoint is reached. Marker N2 controls the direction coil DC6 of counter C6. If N2 is 1 (activated), counter C6 counts down. If the actual value of the counter is 00000, the analog

value comparator A6 resets marker N2. The direction coil DC6 of counter C6 is reset. The counter C6 only operates as an up counter.

Circuit diagram display

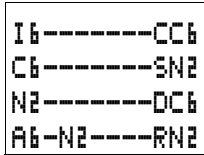

Parameter settings of counter C6

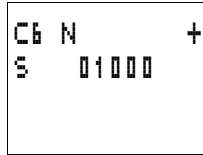

Parameter settings of analog value comparator A6

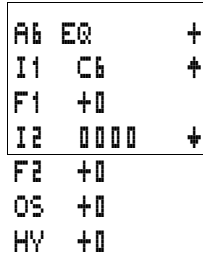

The above example scans the value zero. However, any permissible value within the range of the analog value comparator function block can be entered.

Example: counter with retentive actual value

Select a retentive counter if you wish to retain the actual value of a counter, even after a power failure or a change from RUN to STOP.

- ▶ Select the required counter in the SYSTEM... → RETENTION... menu.

```

M 9 - M12 +
M13 - M16
N 9 - N16
C 5 - C 7 /+
C 8
C13 - C16
T 7
T 8
T13 - T16
D 1 - D 8

```

The example shows the counters C5 to C7 as retentive counters.

Circuit diagram display

```

I1-----CC5
C5-----[Q3
I1-Q3----RC5

```

Parameter settings of counter C5

```

C5 N      +
S  00565

```

The counter has the value 450 before the power supply is switched off.

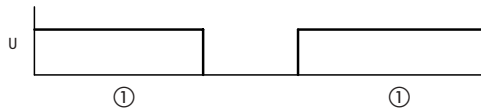

Figure 55: Retentive counter

- ① The numerical value 450 is retained even after a power outage.
U = supply voltage of the device

High-speed counters, easy-DA, easy-DC

easy provides various high-speed counter functions. These counter function blocks are coupled directly to digital inputs. The following functions are possible:

- Frequency counters: C15 and C16
- High-speed counters: C13 and C14.

Frequency counters

easy provides two frequency counters C15 and C16 for use as required. The frequency counters can be used for measuring frequencies. The high-speed frequency counters are permanently connected to the digital inputs I3 and I4.

Frequency counters C15 and C16 can be used for determining motor speeds, volume measurement using volume meters or the running of a motor.

The frequency counter allows you to enter an upper threshold value as a comparison value. The C15 and C16 frequency counters are not dependent on the cycle time.

Counter frequency and pulse shape

The maximum counter frequency is 1 kHz.

The minimum counter frequency is 4 Hz.

The signals must be square waves. We recommend a mark-to-space ratio of 1:1.

If this is not the case:

The minimum mark-to-space ratio is 0.5 ms.

$$t_{\min} = 0.5 \times \frac{1}{f_{\max}}$$

t_{\min} = minimum time of the pulse or pause duration

f_{\max} = maximum count frequency (1 kHz)



Frequency counters operate independently of the program cycle time. The result of the actual value setpoint comparison is only transferred once every program cycle for processing in the circuit diagram.

The reaction time in relation to the setpoint/actual value comparison can therefore be up to one cycle.

Measurement method

The pulses on the input are counted for one second irrespective of the cycle time, and the frequency is determined. The measurement result is provided as an actual value.

Wiring of a frequency counter

The following assignment of the digital inputs apply.

- I3 counter input for frequency counter C15
- I4 counter input for frequency counter C16.



If you use C15 or C16 as frequency counters, coils DC15 or DC16 will have no function. The counter signals are transferred directly from the digital inputs I3 and I4 to the counters. A frequency counter measures the actual value and does not measure a direction.

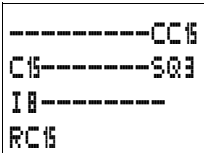

You only integrate a frequency counter into your circuit in the form of a contact and enable coil. The coils and contacts have the following meanings:

Contact	Coil	
C15 to C16		The contact switches if the actual value is greater than or equal to the setpoint.
	CC15, CC16	Enable of the frequency counter on "1" state, coil activated
	RC15, RC16	Reset, coil triggered: actual value reset to 00000



The frequency counter can also be enabled specifically for a special operating state. This has the advantage that the cycle time of the device is only burdened with the frequency measurement when it is taking place. If the frequency counter is not enabled, the cycle time of the device is shorter.

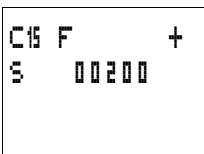

Parameter display and parameter set for frequency counter:

C15	Counter function relay number 15
F	Mode F: frequency counter
+	<ul style="list-style-type: none"> • + appears in the PARAMETER menu. • - does not appear in the PARAMETER menu.
S	Setpoint, constant from 00000 to 01000 (32 000 is a possible setting, the maximum frequency is 1 kHz)

In the parameter display of a counter relay you change the mode, the setpoint and the enable of the parameter display.

Value range

The counter relay counts between 4 and 1 000 [Hz].

Parameter display in RUN mode:

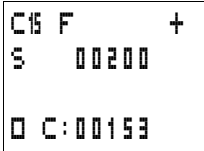

— Current setpoint, constant (0309)

— Contact has not switched.

Contact has switched.

Actual value (0153)

Retention

Setting retention on the frequency counter serves no purpose since the frequency is continuously remeasured.

Function of the frequency counter

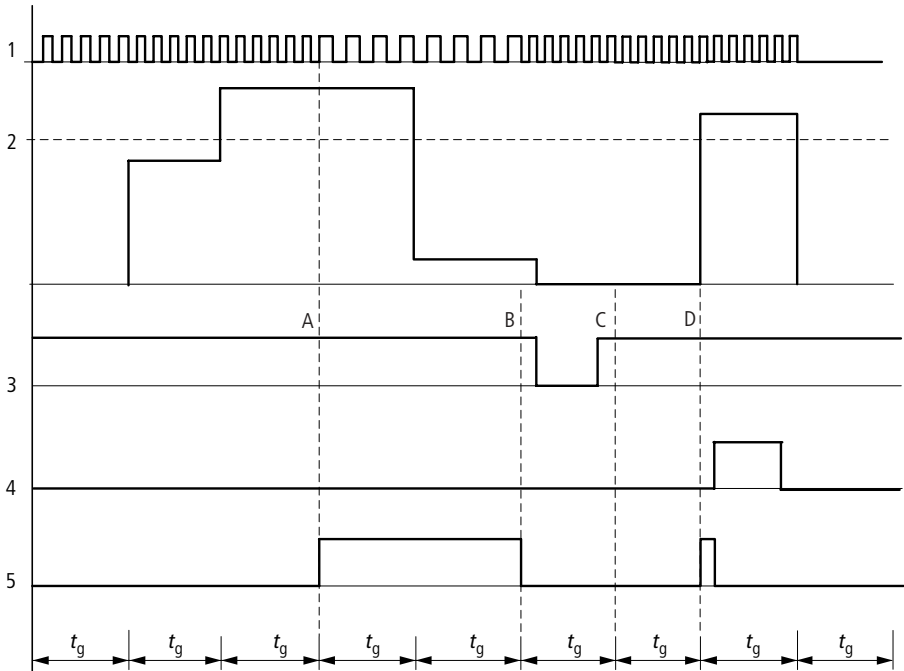

Figure 56: Signal diagram of the frequency counter

1: counter input I3 or I4

2: upper setpoint

3: enable coil CC...

4: reset coil RC...

5: contact (make contact) C... upper setpoint value reached.

 t_g : gate time for the frequency measurement

- Range A: the counter is enabled. Contact C15 (C16) switches after a frequency above the setpoint was measured for the first time.
- Range B: If the actual value falls below the setpoint, the contact is reset. The removal of the enable signal resets the actual value to zero.
- Range C: the counter is enabled. After a frequency above the setpoint was measured for the first time, contact C15 (C16) switches.
- Range D: The reset coil resets the actual value to zero.

Example: frequency counter

Frequency counters with different switch points

The frequency measured at input I3 is to be classified in different value ranges. The analog value comparator is used as an additional comparison option.

The counter is enabled via marker N3. The value 900 or higher is detected by frequency counter C15 as the upper limit value. This triggers the coil of marker N4.

If the frequency is higher than 600 Hz, analog value comparator A1 indicates this and triggers marker N5.

If the frequency is higher than 400 Hz, analog value comparator A2 indicates this and triggers marker N6.

Circuit diagram display

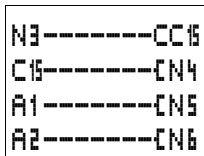

Parameter settings of the counter C15

C15	F	+
S	00900	

Parameter settings of the analog value comparator A1

A1	GE	+
I1	C15	+
F1	+0	
I2	0600	+

Parameter settings of the analog value comparator A2

A2	GE	+
I1	C15	+
F1	+0	
I2	0400	+

F2	+0	
OS	+0	
HY	+0	

F2	+0	
OS	+0	
HY	+0	

High-speed counter

You can use the high-speed counters to count high frequency signals reliably.

easy provides two high-speed up/down counters C13 and C14 for use as required. The high-speed counter inputs are permanently connected to the digital inputs I1 and I2. These counter relays allow you to count events independently of the cycle time.

The high-speed counters allow you to enter an upper threshold value as a comparison value. The C13 and C14 high-speed counters are not dependent on the cycle time.

Counter frequency and pulse shape

The maximum counter frequency is 1 kHz.

The signals must be square waves. We recommend a mark-to-space ratio of 1:1.

If this is not the case:

The minimum mark-to-space ratio is 0.5 ms.

$$t_{\min} = 0.5 \times \frac{1}{f_{\max}}$$

t_{\min} = minimum time of the pulse or pause duration

f_{\max} = maximum count frequency (1 kHz)



High-speed counters operate independently of the program cycle time. The result of the actual value setpoint comparison is only transferred once every program cycle for processing in the circuit diagram.

The reaction time in relation to the setpoint/actual value comparison can therefore be up to one cycle in length.

Wiring of a high-speed counter

The following assignment of the digital inputs apply.

- I1: high-speed counter input for counter C13.
- I2: high-speed counter input for counter C14.



If you use C13 or C14 as high-speed counters you must enable them with the coil CC13 or CC14 accordingly.

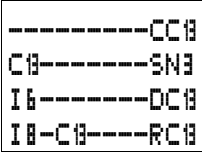

You integrate a high-speed counter into your circuit in the form of a contact and coil.

The coils and contacts have the following meanings:

Contact	Coil	
C13 to C14		The contact switches if the actual value is greater than or equal to the setpoint.
	CC13, CC14	Enable of the high-speed counter on 1 signal coil activated
	DC13, DC14	Counting direction <ul style="list-style-type: none"> • Status 0, not activated, up counting. • Status 1, activated, down counting.
	RC13, RC14	Reset, coil triggered: actual value reset to 00000



The high-speed counter can also be enabled specifically for a special operating state. This has the advantage that the cycle time of the device is only burdened with the counting when it is taking place. If the high-speed counter is not enabled, the cycle time of the device is shorter.

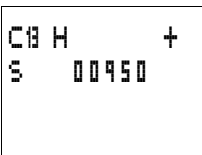

Parameter display and parameter set for the high-speed counter:

C13	Counter function relay number 13
H	H high-speed counter mode (H = high speed)
+	<ul style="list-style-type: none"> • + appears in the PARAMETER menu. • - does not appear in the PARAMETER menu.
S	Setpoint, constant from 00000 to 32000

In the parameter display of a counter relay you change the mode, the setpoint and the enable of the parameter display.

Value range

The counter relay counts between 0 and 32 000.

Behaviour when value range is reached

The easy control relay is in RUN mode.

The value is retained if the counter reaches 32 000. If the counter counts down and reaches 0, this value is retained.

Parameter display in RUN mode:

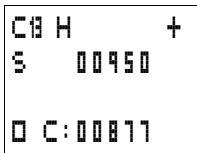

— Current setpoint, constant (1 250)

— Contact has not switched.

Contact has switched.

Actual value (877)

Retention

The high-speed counter can be run with the retentive actual value. You can select the retentive counter relays in the SYSTEM... → RETENTION... menu. C5 to C7, C8 and C13 to C16 can be selected.

If a counter relay is retentive, the actual value is retained when the operating mode changes from RUN to STOP as well as when the power supply is switched off.

When easy is restarted in RUN mode, the counter relay continues with the retentively stored actual value.

Function of the high-speed counter function block

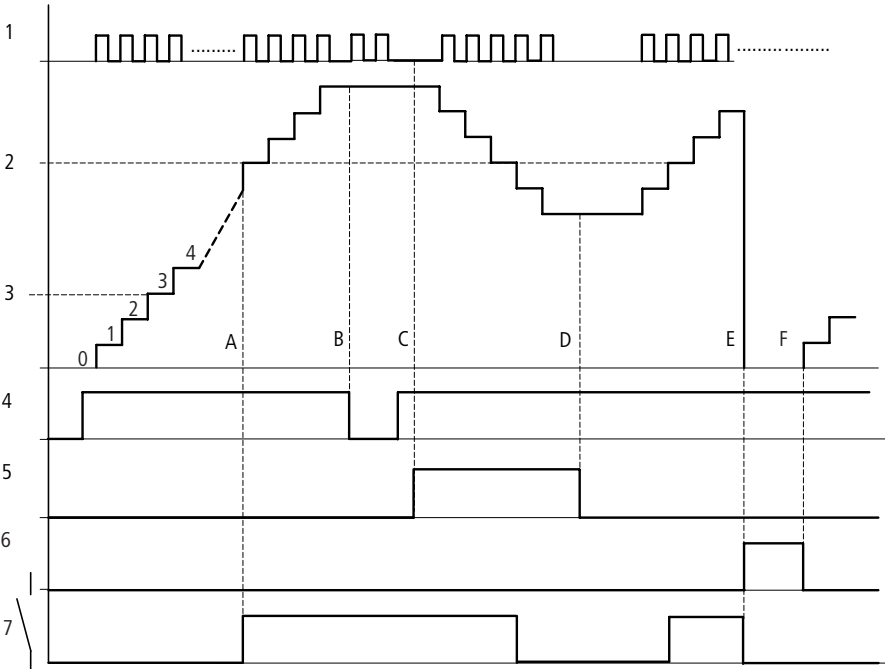

Figure 57: Signal diagram of the high-speed counter

- 1: count pulses at counter input I1(I2)
- 2: setpoint of the counter
- 3: actual value of the counter
- 4: enable of the counter, CC13 (CC14)
- 5: count direction, direction coil DC13 (DC14)
- 6: reset coil of the counter RC13 (RC14)

7: contact of the counter, C13 (C14)

- Range A: The relay contact C13 (C14) of the counter with setpoint value 512 switches as soon as the actual value is 512.
- Range B: When new count pulses or the counter enable are not present, the actual value is retained.
- Range C: If the count direction is reversed DC13 (DC14), the contact is reset when the actual value is 511.
- Range D: the count direction is set to up counting
- Range E: The Reset coil RC13 (RC14) resets the counter to 0. No pulses are counted.
- Range F: the Reset coil is not active, pulses are counted.



In the examples it must be remembered that there may be a time difference of up to one program cycle between the setpoint/actual value comparison and the processing of the result. This may cause deviations in values.

Example: counting measuring pulses and setting an output

Measuring pulses can represent lengths, rotations, angles or other values. These program sections are required for applications involving the filling of sacks, bags or the cutting of foil.

The count signals are continuously present at I1. The high-speed counter C13 counts these pulses. The counter is automatically set to zero if the actual value equals the setpoint. Contact C13 is then set for one program cycle. The output Q3 is set at the same time. This is then reset by input I8.

Circuit diagram display

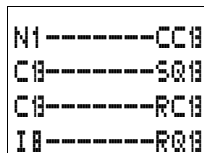

Parameter settings of the
C13 counter

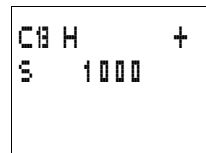

Example running motors or spindles in parallel.

Applications may involve motion control with the parallel control of two drives. Only certain deviations are permissible so that the mechanical system does not jam.

These tasks can be implemented with the following solution.

I8 starts the drives. I7 and I6 carry the feedback signals of the motor-protective circuit-breakers. The drives are stopped if a motor-protective circuit-breaker trips. The analog value comparators control the difference of the path distance. The appropriate drive is stopped temporarily if one path distance is outside of the set tolerance. The coils and contacts have the following meanings:

- M8 = enable for all drives
- Q1 = drive 1, counter drive 1 is connected with input I1 and this with high-speed counter C13.
- Q2 = drive 2, counter drive 2 is connected with input I2 and this with high-speed counter C14.
- A1 = comparison, if C13 is less than C14, drive 2 is too fast.
- A2 = comparison, if C14 is less than C13, drive 1 is too fast.
- A3 = comparison, if C13 and C14 are equal, both drives can be activated.
- The hysteresis value of A1, A2 and A3 depends on the resolution of the transducer and the mechanical system.

Circuit diagram display

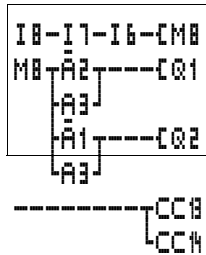

Parameter settings of the counter C13

C13 H	+
S	+0

Parameter settings of the counter C14

```
C14 H      +
S      +0
```

Parameter setting of analog value comparators A1 and A2

```
A1 LT      +
I1 C13     +
F1 +0
I2 C14     +
F2 +0
OS +0
HY 0015
```

```
A2 LT      +
I1 C14     +
F1 +0
I2 C13     +
F2 +0
OS +0
HY 0015
```

Parameter settings A3

```
A1 EQ      +
I1 C13     +
F1 +0
I2 C14     +
F2 +0
OS +0
HY 0020
```

Text display

easy500 and easy700 can display up to 16 user-defined texts. These texts can be triggered by the actual values of function relays such as timing relays, counters, operating hours counters, analog value comparators, date, time or scaled analog values. The setpoints of timing relays, counters, operating hours counters, analog value comparators can be modified when the text is displayed. The text display can only be edited with EASY-SOFT (-BASIC, -PRO from version 6.xx or higher). The texts are saved in the EASY-SOFT file or on the EASY-M-32K memory card for easy500 and easy700.



Compatibility with easy600

If you wish to load an existing easy600 circuit diagram, the available text display functions are retained. The text display in easy500 and easy700 devices operates in the same way as in an easy600 device.

Wiring a text display

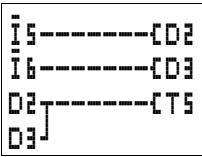

You integrate a text display into your circuit in the form of a contact and coil.

The coils and contacts have the following meanings:

Contact	Coil	
D1 to D16		Coil of the corresponding text display is triggered
	C, J, L, J, S, R D1 to D16	If a coil is triggered, the text is shown in the display.

The text display does not have a parameter display in the PARAMETER menu.

Retention

The texts D1 to D8 can be operated with retentive actual values (contacts).

If the text displays are retentive, the actual value is retained when the operating mode changes from RUN to STOP as well as when the power supply is switched off.

When easy is restarted in RUN mode, the text displays D1 to D8 continue with the retentively stored actual value.

```
SWITCH,
CONTROL,
DISPLAY,
EASY! EASY!
```

Example of a text display:

The text display can display the following:

```
RUNTIME M:S
T1 :012:46
C1 :0355 ST
PRODUCED
```

—Line 1, 12 characters

—Line 2, 12 characters, a setpoint or actual value

—Line 3, 12 characters, a setpoint or actual value

—Line 4, 12 characters

Scaling

The values of the analog inputs can be scaled.

Range	Selectable display range	Example
0 to 10 V	0 to 9999	0000 to 0100
0 to 10 V	± 999	−025 to 050
0 to 10 V	± 9.9	−5.0 to 5.0

Function

The D (D = “Display”) text display function relay works in the circuit diagram like a normal M marker. A “1” signal at the coil will cause a stored text to be displayed in the easy display line. For this to take place, the easy must be in RUN mode and the Status display must be activated before the text is displayed.

D2 to D16:

If several texts are present and are triggered, each text is automatically displayed in turn every 4 s. This process will be repeated until

- No other text display function block is set to “1”.
- STOP mode is selected.

- easy's power supply is no longer present.
- The **OK** or **DEL + ALT** buttons are used to switch to a menu.
- A setpoint is entered.
- The text for D1 is displayed.

D1:

D1 is designed as an alarm text. If D1 is activated, the text assigned to it will be displayed until

- The coil D1 is reset to 0.
- STOP mode is selected.
- easy's power supply is no longer present.
- The **OK** or **DEL + ALT** buttons are used to switch to a menu.

Text entry

The text can only be entered with EASY-SOFT (-BASIC, -PRO from version 6.xx or higher).

Character set

All ASCII characters in upper and lower case are permissible.

- A B C D E F G H I J K L M N O P Q R S T U V W X Y Z
- a b c d e f g h i j k l m n o p q r s t u v w x y z

The following special characters are permissible:

! „ " # \$ % & ' () * + , - . / 0 1 2 3 4 5 6 7 8 9

Counter with actual value	Analog input scaled as temperature value	D1 as error message on fuse failure
<pre> QUANTITY PCE:0042 !COUNTING! </pre>	<pre> TEMPERATURE OUT -010 DEG IN +010 DEG HEAT.. </pre>	<pre> FUSE FAILURE HOUSE 1 </pre>

Figure 58: Text output examples

Entering a setpoint in a display

A text can contain two values such as actual values and setpoints of function relays, analog input values and time and date. The position of setpoints and actual values is fixed to the centre of lines 2 and 3. The length depends on the value to be displayed. Setpoint entries in the text display are useful if the PARAMETER menu is not available for display or entry. Also when the operator is to be shown which setpoint is being modified.

<pre>RUNTIME M:S</pre>	—Line 1
<pre>T1 :012:46</pre>	—Line 2, setpoint can be edited
<pre>C1 :0355 ST</pre>	—Line 3, setpoint can be edited
<pre>PRODUCED</pre>	—Line 4



The corresponding text function block must be displayed in order to change a setpoint. The setpoint must be a constant.



When values are being entered, the text is retained statically on the display. The actual values are updated.

The example shows the following.

The setpoint of timing relay T1 is to be changed from 12 minutes to 15 minutes.

- Line 2: setpoint of timing relay T1, can be edited.
- Line 3: actual value of timing relay T1.

The text is displayed.

```
STIR    M:S
S :    012:00
ACT:   008:33
BREAD ROLLS
```

- ▶ Pressing the **ALT** button will cause the cursor to jump to the first editable value.

```
STIR    M:S
S :    012:00
ACT:   008:33
```

In this operating mode, you can use the cursor buttons ^v to move between different editable constants.

- ▶ Press the **OK** button, the cursor will jump to the highest digit of the constant to be modified.

```
STIR    M:S
S :    012:00
ACT:   008:33
BREAD ROLLS
```

In this operating mode use the cursor buttons ^v to modify the value. Use the cursor buttons < > to move between digits.

Use the **OK** button to accept the modified value. Use the **ESC** button to abort the entry and leave the previous value.

```
STIR    M:S
S :    015:00
ACT:   008:34
BREAD ROLLS
```

- ▶ Press the **OK** button, the cursor will move from constant to constant.

```
STIR    M:S
S :    015:00
ACT:   008:34
BREAD ROLLS
```

The modified value is accepted.

Press the **ESC** button to leave Entry mode.

```
STIR    M:S
S :    015:00
ACT:   008:34
BREAD ROLLS
```

7-day time switch

easy500 and easy700 with type suffix EASY...-...-C are provided with a real-time clock. The time switches can only be used effectively in these devices.



The procedure for setting the time is described under section "Setting date, time and daylight saving time" on page 213.

easy offers eight 7-day time switches Q1 to Q8 for up to 32 switch times.



Each time switch has four channels which you can use to set four on and off times. The channels are set via the parameter display.

The timer has a back-up battery. This means that it will continue to run in the event of a power failure, although the time switch relays will not switch. When the timer is disconnected from the power supply, the contacts remain open. Information on the battery back-up time are provided on page 264.



Compatibility with easy400 and easy600

If you wish to load an existing easy400 or easy600 circuit diagram, the existing 7-day time switch functions are retained. The 7-day time switch in easy500/700 devices operates in the same way as in an easy400/600 device.

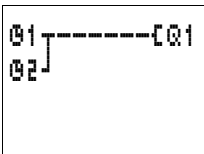

A 7-day time switch can be integrated into your circuit in the form of a contact.

Contact	Coil	
Q1 to Q8		Contact of the 7-day time switch

```

01 A      +
D      SU
ON  --:--
OFF --:--
    
```

Parameter display and parameter set for 7-day time switch:

01	7-day time switch function relay 1
A, B, C, D	Time switch channels
+	<ul style="list-style-type: none"> • + appears in the PARAMETER menu, • - does not appear in the PARAMETER menu.
D	Day setting, from -- to --
ON	On time
OFF	Off time

The parameter display for a 7-day time switch is used to modify the weekdays, the on time, the off time and enable of the parameter display.

Compatibility between easy400 and easy500, easy600 and easy700 7-day time switches

The parameter display for easy500 and easy700 has been changed. The easy400 and easy600 parameters can be found at the following points.

```

      [ AA-BB ]
ON  [ ---:-- ] A
OFF [ ---:-- ] +
    
```

easy400, easy600 parameters

```

01
AA-BB
A
ON ---:--
OFF ---:--
+
    
```

easy500, easy700 parameters

```

= 01
= AA-BB
= A
= ON ---:--
= OFF ---:--
= +
    
```

```

01 A      +
D      AA-BB
ON  --:--
OFF --:--
    
```

Table 13: On and off times

Parameters	Meaning	Meaningful values
Day of the week	Monday to Sunday	MO, TU, WE, TH, FR, SA, SU, --
On time	Hours: Minutes: No time set at "--:--"	00:00 to 23:59, --:--
Off time	Hours: Minutes: No time set at "--:--"	00:00 to 23:59, --:--

Parameter display in RUN mode:

01 A 11:30 +	Selected channel, current time (only in RUN)
D MO-FR	Weekday(s) from - to
ON 06:45	On time
OFF 19:30 ■	Off time
	□ Contact has not switched.
	■ Contact has switched.

Changing time switch channel

You can change time switch channel in either RUN or STOP mode by selecting the channel required with the cursor buttons ^\.

Example:

The parameter display of the 7-day time switch is active. The cursor is flashing on channel A.

01 A 11:30 +
D MO-FR
ON 06:45
OFF 19:30 ■

► Press the ^ button to move the cursor to channel B.

Press the > button to reach any value that can be edited.

01 B 11:30 +
D SA
ON 06:45
OFF 15:00 ■

Function of the 7-day time switch

The following examples illustrate the function of the 7-day time switch.

Work days example

The time switch 01 switches on Monday to Friday between 6:30 and 9:00 and between 17:00 and 22:30.

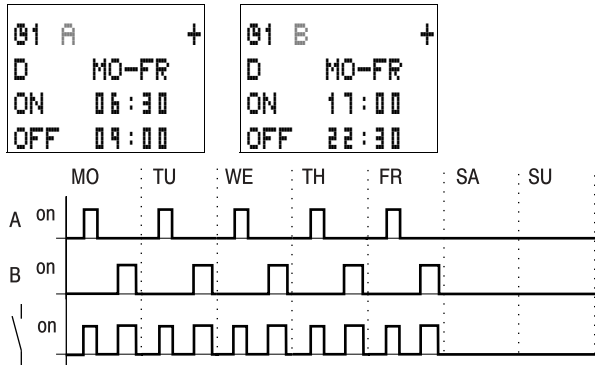

Figure 59: Work days signal diagram

Weekends example

Time switch 02 switches on at 16:00 on Friday and switches off at 6:00 on Monday.

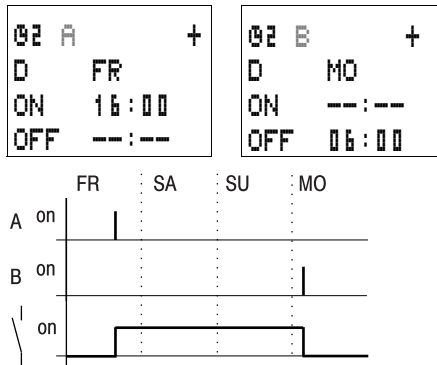

Figure 60: Weekend switching signal diagram

Night switching example

Time switch 03 switches on at 22:00 on Monday and switches off at 6:00 on Tuesday.

03 D	+
D	MO
ON	22:00
OFF	06:00

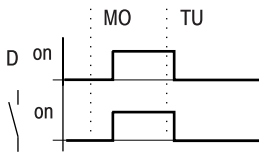

Figure 61: Night switching signal diagram



If the off time is before the on time, easy will switch off on the following day.

Time overlaps example

The time settings of a time switch overlap. The clock switches on at 16:00 on Monday, whereas on Tuesday and Wednesday it switches on at 10:00. On Monday to Wednesday the off time is 22:00.

04 A	+
D	MO-WE
ON	16:00
OFF	22:00

04 B	+
D	TU-WE
ON	10:00
OFF	00:00

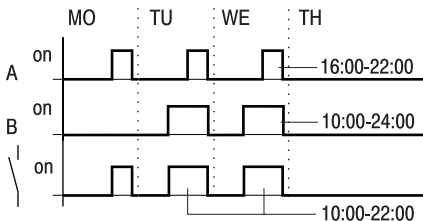

Figure 62: Time overlaps signal diagram



On and off times always follow the channel which switches first.

Power failure example

The power is removed between 15:00 and 17:00. The relay drops out and remains off, even after the power returns, since the first off time was at 16:00.

04 A		+	04 B		+
D	MO-SU		D	MO-SU	
ON	12:00		ON	12:00	
OFF	16:00		OFF	18:00	



When it is switched on, easy always updates the switching state on the basis of all the available switching time settings.

24 hour switching example

The time switch is to switch for 24 hours. On time at 0:00 on Monday and off time at 0:00 on Tuesday.

01 A		+	01 B		+
D	MO		D	TU	
ON	00:00		ON	--:--	
OFF	--:--		OFF	00:00	

Operating hours counter

easy provides 4 independent operating hours counters. These operating hours counters enables you to record the operating hours of systems, machines and machine parts. An adjustable setpoint can be selected within the value range. In this way, maintenance times can be logged and reported. The counter states are retained even when the device is switched off. As long as the count coil of the operating hours counter is active, easy counts the hours in second cycles.

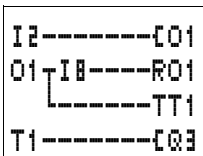

You integrate an operating hours counter into your circuit in the form of a contact and coil.

Contact	Coil	
Q1 to Q4		
	C01 to C04	Count coil of the operating hours counter
	R01 to R04	Reset coil of the operating hours counter

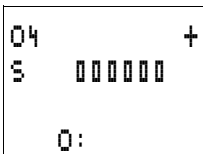

Parameter display and parameter set for the operating hours counter function block:

Q4	Operating hours counter number 4
+	<ul style="list-style-type: none"> • + appears in the parameter display • - appears in the parameter display
S	Setpoint in hours
O:	Actual value of the operating hours counter in hours [h]

In the parameter display of an operating hours counter you change the setpoint in hours and the enable of the parameter display.

Parameter display in RUN mode:

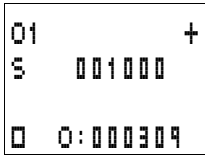

— Set time in hours

— Actual time in hours

☐ Contact has not switched.

■ Contact has switched.

Value range of the operating hours counter

The operating hours counter counts in the range from 0 hours to way over 100 years.

Accuracy of the operating hours counter

The operating hours counter counts in seconds. When the device is switched off, up to 999 ms can be lost.

Function of the operating hours counter function block

When the coil of the O operating hours counter is set to 1, the counter increments its actual value by 1 (basic pulse: 1 second).

If the actual value of the operating hours counter reaches the setpoint of S, the contact O... switches for as long as the actual value is greater than or equal to the setpoint.

The actual value is kept stored in the device until the Reset coil RO... is triggered. The actual value is then set to zero.



Operating mode change RUN, STOP, power On, Off, Delete program, Change program, Load new program. All these functions do not clear the actual value of the operating hours counter.

Example: operating hours counter

Operating hours counter for the operating time of a machine. The time in which a machine (easy) is energized is to be measured.

Circuit diagram display

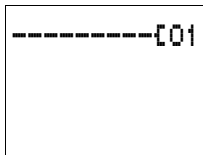

Parameter settings of operating hours counter O1

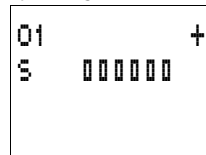

Example: maintenance meters for different machine areas

Machine areas have to be maintained after different times have elapsed. Markers N1 and N2 are the on markers of two different machine areas. These markers control the associated operating hours counters. Output Q4 switches on a warning light if the setpoint of an operating hours counter has been reached. A keyswitch at input I8 resets the associated operating hours counter after maintenance has been completed.

Circuit diagram display

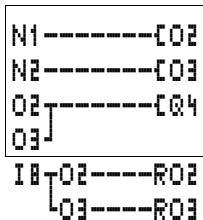

Parameter settings of operating hours counter O2

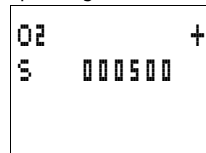

Parameter settings of operating hours counter O3

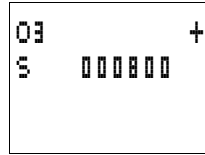

Example maintenance meter for different machine sections, with text output

The entire machine operating time is to be counted. Machine areas have to be maintained after different times have elapsed. Markers N1 and N2 are the On markers of two different machine areas. These markers control the associated operating hours counters. Output Q4 switches on a warning light if the setpoint of an operating hours counter has been reached. This should flash. A keyswitch at input I8 resets the associated operating hours counter after maintenance has been completed.

The entire machine operation time is to be displayed continuously. The run time of the machine sections should only be displayed once the maintenance interval has elapsed.

Circuit diagram display

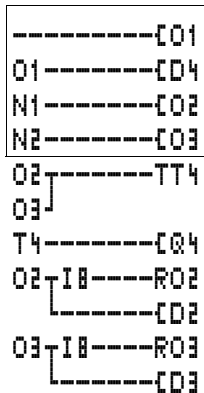

Parameter settings of operating hours counter O1

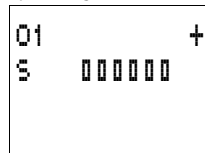

Parameter settings of
operating hours counter O2

```
O2      +
$      000500
```

Parameter settings of
operating hours counter O3

```
O3      +
$      000800
```

Parameter setting of timing
relay T1

```
T1  ⌵    $  +
I1  02.000
I2  01.500
T:
```

Text of text display D2

```
MAINTENANCE
REQUIRED
HRS:000501
MACHINE 01
```

Text of text display D3

```
MAINTENANCE
REQUIRED
HRS:000800
MACHINE 02
```

Text of text display D4

```
RUNTIME
MACHINE
HRS:001955
```

Timing relays

easy provides 16 timing relays T1 to T16 for use as required.

A timing relay is used to change the switching duration and the make and break times of a switch contact. The delay times can be configured between 2 ms and 99 h 59 min. You can use positive values, values of analog inputs, actual values of counter relays and timing relays.

You can also use easy as a multi-function relay in the application. easy is more flexible than any hardwired timing relay since you can wire all the functions at the push of a button as well as program additional functions.



The timing relays of easy500 and easy700 function in the same way as the timing relays of easy400 and easy600.

Exception: The "flash" function starts on easy500 and easy700 with the pulse. With easy400 and easy600 the "flash" function starts with the pause. If required, the same timing relays can also be used for retentive data.

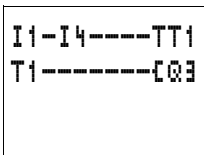

You integrate a timing relay into your circuit in the form of a contact and coil.

Contact	Coil	
T1 to T1		Contact of a timing relay
	TT1 to TT1	Enable, timing relay trigger
	RT1 to RT1	Reset coil of the timing relay
	HT1 to HT1	Stop coil of the timing relay (H = Stop , S means the Set coil function)



To prevent unpredictable switching states, use each coil of a relay once only in the circuit diagram.

```

T1 X   S +
I1   00.000
I2   00.000
T:
    
```

Parameter display and parameter set for a timing relay:

T1	Timing relay number 1
X	On-delayed mode
S	Time range in seconds
+	<ul style="list-style-type: none"> • + appears in the PARAMETER menu. • - does not appear in the PARAMETER menu.
I1	Time setpoint 1: <ul style="list-style-type: none"> • Positive value, I7, I8, I11, I12 • Actual value T1 to T16, C1 to C16
I2	Time setpoint 2 (with timing relay with 2 setpoints): <ul style="list-style-type: none"> • Positive value, I7, I8, I11, I12 • Actual value T1 to T16, C1 to C16
T:	Display of actual value in RUN mode

In the parameter display of a timing relay you can change the mode, the time base, the time setpoint 1, time setpoint 2 (if necessary) and the enable of the parameter display.

Compatibility between easy400 and easy500, easy600 and easy700 timing relays

New functions have been added to the parameter display of easy500 and easy700. The easy400 and easy600 parameters can be found at the following points.

```

X [
S [ AA.BB ]
C [ TRG ] } T1
  [ RES ]
    
```

easy400, easy600 parameters

```

T1
X
S
AA.BB
+
    
```

easy500, easy700 parameters

```

= T1
= X
= S
= AA.BB
= +
    
```

```

T1 X   S +
I1 AA.BB
I2
    
```

Parameter display in RUN mode:

```

T1 X  S  +
I1  10.000
I2  00.000
□ T:03.305

```

- Mode, time base
- Time setpoint 1
- Time setpoint 2
- Actual value of elapsed time
- Contact has not switched.
- Contact has switched.

Retention

Timing relays can be run with retentive actual values. Select the number of retentive timing relays in the SYSTEM... → RETENTION... menu. T7, T8, T13 to T16 can be used as retentive timing relays.

If a timing relay is retentive, the actual value is retained when the operating mode is changed from RUN to STOP and when the power supply is switched off.

When easy is restarted in RUN mode, the timing relay continues with the retentively stored actual value.



When easy is restarted, the status of the trigger pulse must be the same as on disconnection.

Status 1 with all operating modes:

- on-delayed,
- single pulse,
- flashing.

Status 0 with all operating modes: off-delayed.

Status 1 or 0 (as with disconnection): on-delayed

Timing relay modes

Parameters	Switch function
X	Switch with on-delay
?X	Switch with on-delay and random time range
■	Switch with off-delay
?■	Switch with off-delay and random time range
X■	On and off delayed, two time setpoints
?X■	On and off delayed switching with random time, 2 time setpoints
⏏	Single pulse switching
⏏	Flash switching, mark-to-space ratio = 1:1, 2 time setpoints
⏏	Flash switching, mark-to-space ratio ≠ 1:1, 2 time setpoints

Time range

Parameters	Time range and setpoint time	Resolution
S 00.000	Seconds: 0.000 to 99.999 s	1 ms
M:S 00:00	Minutes: Seconds 00:00 to 99:59	1 s
H:M 00:00	Hours: Minutes, 00:00 to 99:59	1 min.



Minimum time setting:

If a time value is less than easy's cycle time, the elapsed time will not be recognised until the next cycle. This may cause unforeseeable switching states.

Variable values as time setpoint (I7, I8, I11, I12, actual value T1 to T16, C1 to C16)



If the value of the variable is greater than the maximum permissible value of the configured time range, the maximum value of the time range will be used as the setpoint.



You can only use analog values as setpoints if the value of the analog input is stable. Fluctuating analog values reduce the reproducibility of the time value.

The following conversion rules apply if you are using variable values such as an analog input:

s time base

Equation: Time setpoint = (Value × 10) in [ms]

Value, e.g. analog input	Time setpoint in [s]
0	00.000
100	01.000
300	03.000
500	05.000
1023	10.230

M:S time base

Rule: Time setpoint = Value divided by 60, Integer result = Number of minutes, remainder is the number of seconds

Value, e.g. analog input	Time setpoint in [M:S]
0	00:00
100	01:40
300	05:00
500	08:20
1023	17:03

Time base H:M

Rule: Time setpoint

= Value divided by 60 Integer result = Number of hours,
remainder is the number of minutes

Value, e.g. analog input	Time setpoint in [H:M]
0	00:00
100	01:40
300	05:00
606	10:06
1023	17:03

Function of the timing relay function block

Timing relay, on-delayed with and without random switching

Random switching: The contact of the timing relay switches randomly within the setpoint value range.

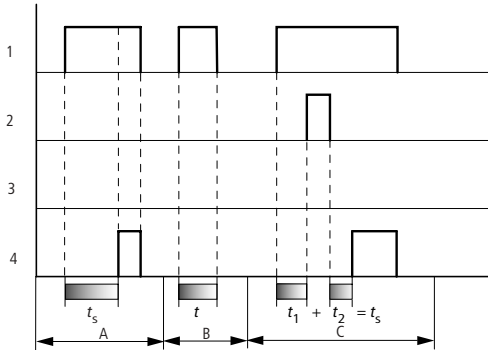

Figure 63: Signal diagram of timing relay, on-delayed (with and without random switching)

- 1: trigger coil TTx
- 2: Stop coil HTx
- 3: Reset coil RTx
- 4: switch contact (make contact) Tx

t_s : setpoint time

- Range A: The set time elapses normally.
- Range B: The entered setpoint does not elapse normally because the trigger coil drops out prematurely.
- Range C: The Stop coil stops the time from elapsing.

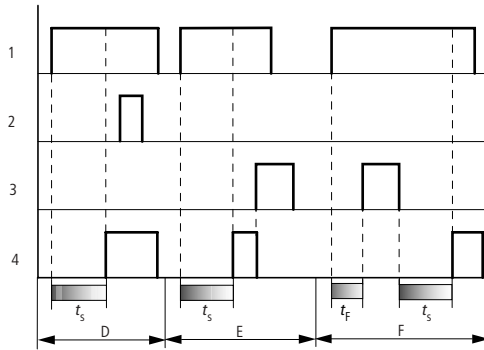

Figure 64: Signal diagram of timing relay, on-delayed
(with and without random switching)

- Range D: The Stop coil is inoperative after the time has elapsed.
- Range E: The Reset coil resets the relay and the contact.
- Range F: The Reset coil resets the time during the timeout sequence. After the Reset coil drops out, the time elapses normally.

Timing relay, off-delayed with and without random switching

Random switching: The contact of the timing relay switches randomly within the setpoint value range.

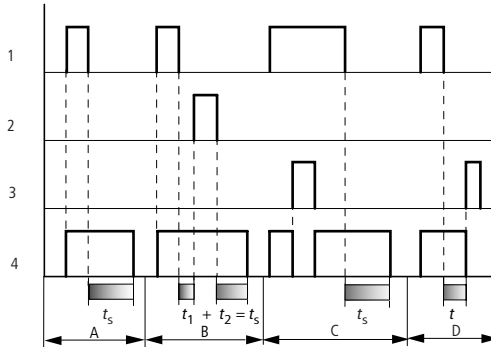

Figure 65: Signal diagram of timing relay, off-delayed (with and without random switching)

- 1: trigger coil TTx
 - 2: Stop coil HTx
 - 3: Reset coil RTx
 - 4: switch contact (make contact) Tx
- t_s : setpoint time

- Range A: The time elapses after the trigger coil is deactivated.
- Range B: The Stop coil stops the time from elapsing.
- Range C: The Reset coil resets the relay and the contact. After the Reset coil drops out, the relay continues to work normally.
- Range D: The Reset coil resets the relay and the contact when the function block is timing out.

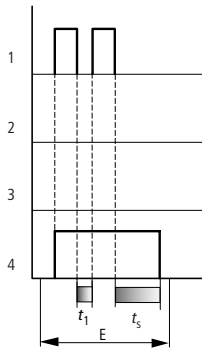

Figure 66: Signal diagram of timing relay, off-delayed
(with/without random switching with retriggering)

Range E: The Trigger coil drops out twice. The actual time t_1 is cleared and the set time t_s elapses completely (retriggerable switch function).

Timing relay, on-delayed and off-delayed with and without random switching

Time value I1: On-delayed time

Time value I2: Off-delayed time

Random switching: The contact of the timing relay switches randomly within the setpoint value ranges.

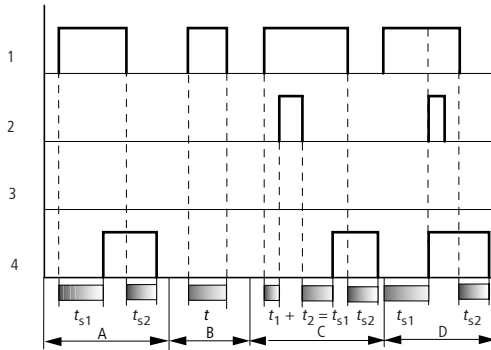

Figure 67: Signal diagram of timing relay, on and off-delayed 1

- 1: trigger coil TTx
- 2: Stop coil HTx
- 3: Reset coil RTx
- 4: switch contact (make contact) Tx

t_{s1} : pick-up time
 t_{s2} : drop-out time

- Range A: The relay processes the two times without any interruption.
- Range B: The trigger coil drops out before the on-delay is reached.
- Range C: The Stop coil stops the timeout of the on-delay.
- Range D: The Stop coil has no effect in this range.

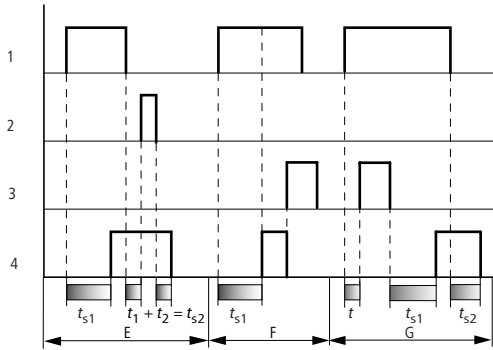

Figure 68: Signal diagram of timing relay, on and off-delayed 2

- Range E: The Stop coil stops the timeout of the off-delay.
- Range F: The Reset coil resets the relay after the on delay has elapsed
- Range G: The Reset coil resets the relay and the contact whilst the on delay is timing out. After the Reset coil drops out, the time elapses normally.

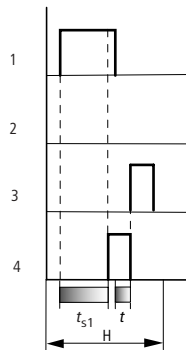

Figure 69: Signal diagram of timing relay, on and off-delayed 3

- Range H: The Reset signal interrupts the timing out of the set time.

Timing relay, single pulse

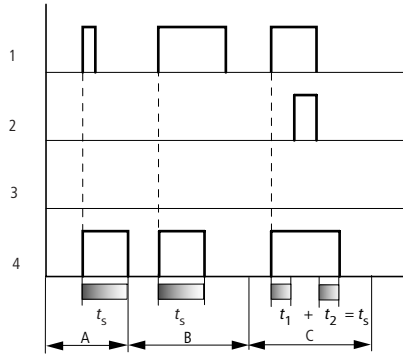

Figure 70: Signal diagram of timing relay, single pulse 1

- 1: trigger coil TTx
- 2: Stop coil HTx
- 3: Reset coil RTx
- 4: switch contact (make contact) Tx

- Range A: The trigger signal is short and is lengthened
- Range B: The Trigger signal is longer than the set time.
- Range C: The Stop coil interrupts the timing out of the set time.

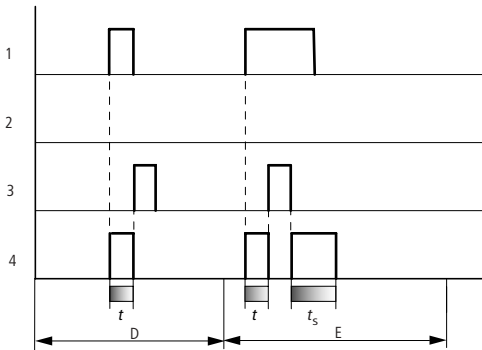

Figure 71: Signal diagram of timing relay, single pulse 2

- Range D: The Reset coil resets the timing relay.
- Range E: The Reset coil resets the timing relay. The Trigger coil is still activated after the Reset coil has been deactivated and the time is still running.

Timing relay, flashing

You can set the mark-to-space ratio to 1:1 or \neq 1:1.

Time value I1: Pulse time

Time value I2: Pause time

Mark-to-space ratio = 1:1 flashing: S1 equals S2

Mark-to-space ratio \neq 1:1 flashing: S1 does not equal S2

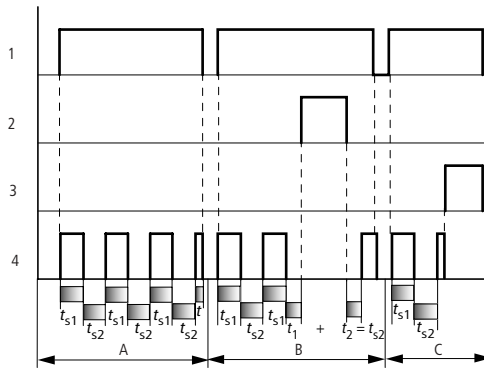

Figure 72: Timing relay signal diagram, flashing

1: trigger coil TTx

2: Stop coil HTx

3: Reset coil RTx

4: switch contact (make contact) Tx

- Range A: The relay flashes for as long as the Trigger coil is activated.
- Range B: The Stop coil interrupts the timing out of the set time.
- Range C: The Reset coil resets the relay.

Timing relay examples

Example: timing relay, on-delayed

In this example a conveyor starts 10 s after the system is powered up.

Circuit diagram display

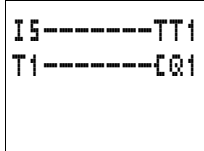

Parameter settings of timing relay T1

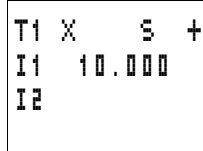

Example: timing relay, off-delayed

The off-delayed function is used to implement a rundown time on the conveyor if required.

Circuit diagram display

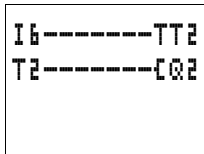

Parameter settings of timing relay T2

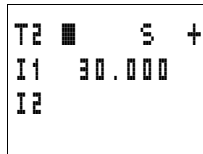

Example: timing relay, on and off-delayed

The on/off-delayed function is used to implement the delay of both the startup and the shutdown if required.

Circuit diagram display

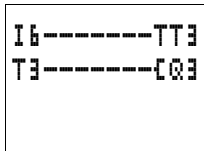

Parameter settings of timing relay T3

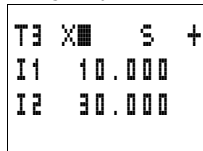

Example: timing relay, single pulse

The input pulses present may vary in length. These pulses must be normalised to the same length. The Single pulse function can be used very simply to implement this.

Circuit diagram display

```

I1-----TT4
T4-----[Q4

```

Parameter settings of timing relay T4

```

T4  0  S  +
I1  10.000
I2

```

Example: timing relay, flashing

This example shows a continuous flash pulse function. Outputs Q3 or Q4 flash according to the marker states of M8 or M9.

Circuit diagram display

```

-----TT5
T5 M8----[Q3
  M9----[Q4

```

Parameter settings of timing relay T5

```

T5  0  S  +
I1   2.000
I2   1.000

```

Example: on-delayed timing relay with retentive actual value

Select a retentive timing relay if you wish to retain the actual value of a timing relay, even after a power failure or a change from RUN to STOP.

```

M 9 - M12 ✓+
M13 - M16
N 9 - N16
C 5 - C 7 +
C 8
C13 - C16
T 7 ✓
T 8 ✓
T13 - T16
D 1 - D 8
    
```

► Select the required timing relay in the SYSTEM... → RETENTION... menu.

The example shows the timing relays T7, T8 as retentive timing relays. Markers M9 to M12 were also selected as retentive.

Circuit diagram display

Parameter settings of timing relay T8

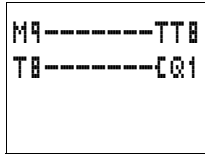

```

T8 X M:S +
I1 15:00
I2
    
```

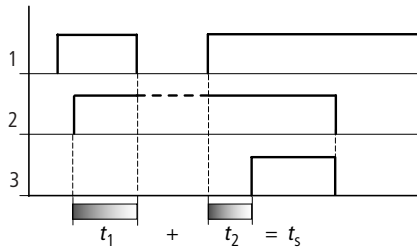
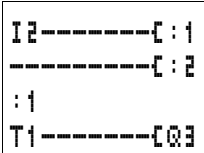

Figure 73: Function the circuit

- 1: power supply
- 2: status of marker M9 and thus trigger signal T8
- 3: status of make contact T8

Jumps

Jumps can be used to optimise the structure of a circuit diagram or to implement the function of a selector switch. Jumps can be used for example to select whether manual/automatic operation or other machine programs are to be set.



You integrate : 1 jumps into your circuit in the form of a contact and coil. Jumps consist of a jump location and a jump label.

Contact	Coil
: 1 to : 1 (can only be used as first leftmost contact)	
	C : 1 to C : 1

Function

If the jump coil is triggered, the rungs after the jump coil are no longer processed. The states of the coils before the jump will be retained, unless they are overwritten in rungs that were not missed by the jump. Jumps are always made forwards, i.e. the jump ends on the first contact with the same number as that of the coil.

- Coil = jump when 1
- Contact only at the first leftmost contact = Jump label

The Jump label contact point is always set to "1".



Backward jumps are not possible with easy due to the way it operates.

If the jump label does not come after the jump coil, the jump will be made to the end of the circuit diagram. The last rung will also be skipped.

Multiple use of the same jump coil and jump contact is possible as long as this is implemented in pairs, i.e.:
Coil \overline{J} : 1 /jumped section/Contact : 1 , Coil \overline{J} : 1 /jumped section/Contact : 1 etc.



Attention!

The states of jumped rungs are retained. The time value of timing relays that have been started will continue to run.

Power flow display

Jumped sections are indicated by the coils in the power flow display.

All coils after the jump coil are shown with the symbol \overline{J} of the jump coil.

Example

A selector switch allows two different sequences to be set.

- Sequence 1: Switch on Motor 1 immediately.
- Sequence 2: Switch on Guard 2, Wait time, then switch on Motor 1.

Contacts and relays used:

- I1 sequence 1
- I2 sequence 2
- I3 guard 2 moved out
- I12 motor-protective circuit-breaker switched on
- Q1 motor 1
- Q2 guard 2
- T1 wait time 30.00 s, on-delayed
- D1 text "Motor-protective circuit-breaker tripped"

Circuit diagram:

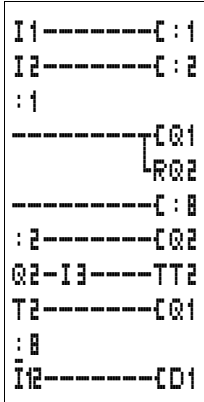

Power flow display: I1 selected:

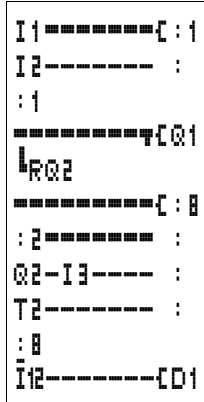

Section from jump label 1 processed.

Jump to label 8.
Section to jump label 8 skipped.

Jump label 8, circuit diagram processed
from this point on.

Year time switch

easy500 and easy700 devices with the type designation easy...-...-C. are equipped with an integrated real-time clock that you can use as a 7-day time switch and year time switch. If you have to implement special on and off switching functions on public holidays, vacations, company holidays, school holidays and special events, these can be implemented easily with the year time switch.



The procedure for setting the time is described under section "Setting date, time and daylight saving time", page 213.

easy offers eight year time switches Y1 to Y8 for up to 32 switch times.

Each time switch has four channels which you can use to set four different on and off times. The channels are set via the parameter display.

The time and date are backed up in the event of a power supply failure and continue to run. This means that it will continue to run in the event of a power failure, although the time switch relays will not switch. When easy is in a de-energized state, the timer contacts remain open. Refer to section "Technical Data", page 264 for information on the buffer time.



The clock module integrated in easy works within the date range 01.01.2000 to 31.12.2099.

Wiring of a year time switch

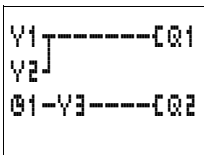

A year time switch can be integrated into your circuit in the form of a contact.

The coils and contacts have the following meanings:

Contact	Coil	
Y1 to Y8		Contact of the year time switch

```

Y1 A      +
ON  --.---
OFF --.---
    
```

Parameter display and parameter set for the year time switch:

Y1	Year time switch function relay 1
A,B, C,D	Time switch channels
+	<ul style="list-style-type: none"> • + appears in the PARAMETER menu. • - does not appear in the PARAMETER menu.
ON	On date: day, month, year (two-digit 2004 = 04)
OFF	Off date: day, month, year (two-digit 2004 = 04)

The parameter display for a year time switch is used to modify the on time, the off time and the enable of the parameter display.

Table 14: On and off times

Parameters	Meaning	Meaningful values
xx.--.00	Date, day	01 to 31
--.xx.00	Month	01 to 12
--.---.00	Year, two-digit	00 to 99

Parameter display in RUN mode:

```

Y1  A      +
ON  01.01.04
OFF 31.12.04
■
    
```

- Selected channel
- On time
- Off time
- □ Contact has not switched.
- Contact has switched.

Changing time switch channel

You can change time switch channel in either RUN or STOP mode by selecting the channel required with the cursor buttons ^v.

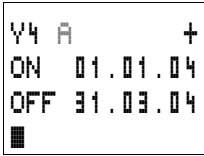

Example:

The display on the left shows the parameter display of a year time switch. The cursor is flashing on channel A.

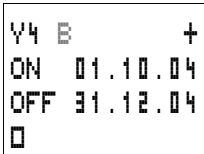

► Press the ^ button to move the cursor to channel B.

Press the > button to reach any value that can be edited.



Important input rules.

The year time switch only operates properly by observing the following rules.

The on year must not be later than the off year.

ON and OFF times must have the same parameters.

Example: ON = Year, OFF = Year; ON = Year/Month, OFF = Year/Month

Entry rules

The following nine entry rules are possible.

Display format: XX = digit used

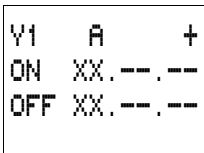

Rule 1

ON: Day

OFF: Day

V1	A	+
ON	--.XX.--	
OFF	--.XX.--	

Rule 2

ON: Month

OFF: Month

V1	A	+
ON	--.--.XX	
OFF	--.--.XX	

Rule 3

ON: Year

OFF: Year

V1	A	+
ON	XX.XX.--	
OFF	XX.XX.--	

Rule 4

ON: Day/month

OFF: Day/month

V1	A	+
ON	--.XX.XX	
OFF	--.XX.XX	

Rule 5

ON: Month/year

OFF: Month/year

V1	A	+
ON	XX.XX.XX	
OFF	XX.XX.XX	

Rule 6

ON: Day/month/year

OFF: Day/month/year

V1	A	+
ON	XX.XX.--	
OFF	--.--.--	

Rule 7

Two-channel

Channel A ON: Day/month

V1	B	+
ON	--.--.--	
OFF	XX.XX.--	

Channel B OFF: Day/month

```

V1   B   +
ON  XX.XX.XX
OFF --.--.XX

```

Rule 8

Two-channel

Channel ON: Day/month/year

```

V1   D   +
ON  --.--.XX
OFF XX.XX.XX

```

Channel D OFF: Day/month/year

With this rule, the same year number must be entered in each channel in the ON and OFF entry area.

Rule 9

Overlapping channels:

The first ON date switches on and the first OFF date switches off.

Function of the year time switch

The year time switch can switch ranges, individual days, months, years or combinations of all three.

Years

ON: 2002 to OFF: 2010 means:

Switch on at 00:00 on 01.01.2002 and switch off at 00:00 on 01.01.2011.

Months

ON: 04 to OFF: 10 means:

Switch on at 00:00 on 1 April and switch off at 00:00 on 1 November

Days

ON: 02 to OFF: 25 means:

Switch on at 00:00 on day 2 and switch off at 00:00 day 26



Avoid incomplete entries. It hinders transparency and leads to unwanted functions.

Example : Selecting year range

The year time switch Y1 is required to switch on at 00:00 on 1 January 2004 and switch off at 23:59 on 31 December 2005.

Circuit diagram display

```
Y1-----[01
```

Parameter settings for the year time switch Y1

```
Y1  A  +
ON  --. --. 04
OFF --. --. 05
```

Example: Selecting month ranges

The year time switch Y2 is required to switch on at 00:00 on 1 March and switch off at 23:59 on 30 September.

Circuit diagram display

```
Y2-----[01
```

Parameter settings for the year time switch Y2

```
Y2  A  +
ON  --. 03. --
OFF --. 09. --
```

Example :Selecting day ranges

The year time switch Y3 is required to switch on at 00:00 on day 1 of each month and switch off at 23:59 on day 28 of each month.

Circuit diagram display

```
Y3-----[01
```

Parameter settings for the year time switch Y3

```
Y3  A  +
ON  01. --. --
OFF 28. --. --
```

Example : Selecting public holidays

The year time switch Y4 is required to switch on at 00:00 on day 25.12 of each year and switch off at 23:59 on day 26.12 of each year. "Christmas program"

Circuit diagram display

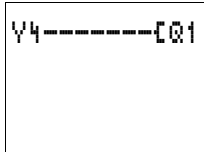

Parameter settings for the year time switch Y4

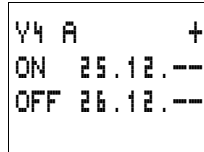

Example: Selecting a time range

The year time switch Y1 is required to switch on at 00:00 on day 02.05 of each year and switch off at 23:59 on day 31.10 of each year. "Open air season"

Circuit diagram display

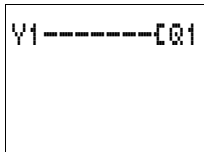

Parameter settings for the year time switch Y1

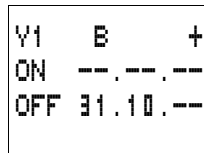
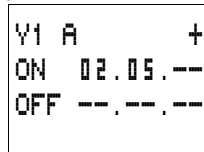

Example: Overlapping ranges

The year time switch Y1 channel C switches on at 00:00 on day 3 of months 5, 6, 7, 8, 9, 10 and remains on until 23:59 on day 25 of these months.

The year time switch Y1 channel D switches on at 00:00 on day 2 of the months 6, 7, 8, 9, 10, 11, 12 and remains on until 23:59 on day 17 of these months.

Circuit diagram display

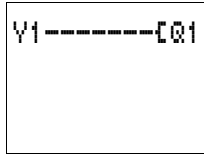

Parameter settings for the year time switch Y1

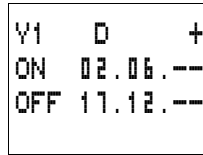
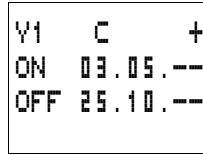

Total number of channels and behaviour of the contact Y1:
 The time switch will switch on at 00:00 from 3 May and off at 23:59 on 25 May.

In June, July, August, September, October, the time switch will switch on at 00:00 on day 2 of the month and switch off at 23:59 on day 17.

In November and December, the time switch will switch on at 00:00 on day 2 of the month and switch off at 23:59 on day 17.

Master reset

The master reset function relay enables you to set with one command the status of the markers and all outputs to "0". Depending on the operating mode of this function relay, it is possible to reset the outputs only, or the markers only, or both. Three function blocks are available.

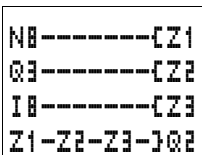

Wiring of the master reset function relay

You integrate a master reset function relay into your circuit in the form of a contact and coil.

The coils and contacts have the following meanings:

Contact	Coil	
Z1 to Z3		Contact of the master reset
	{Z1 to {Z3	Coil of the master reset

Operating modes

The different coils of the master reset have different operating modes

- Z1: For Q outputs: controls outputs Q1 to Q8 and S1 to S8.
- Z2: For markers M, N: controls the marker range M1 to M16 and N1 to N16.
- Z3: for outputs and markers: controls Q1 to Q8, S1 to S8, M1 to M16 and N1 to N16.

Function of the master reset function relay

A rising edge or the 1 signal on the coil will reset the outputs or markers to 0, depending on the operating mode set. The location of the coil in the circuit diagram is of no importance. The master reset always has the highest priority.

The contacts Z1 to Z3 follow the status of their own coil.

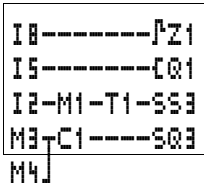

Example: resetting outputs

All outputs that you have used can be reset to 0 with one command.

A rising edge at the coil of Z1 will cause all Q and S outputs to be reset.

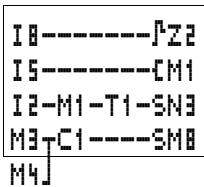

Example: resetting markers

All markers that you have used can be reset to 0 with one command.

A rising edge at the coil of Z2 will cause all markers M and N to be reset.

```

I0-----]Z3
I5-----CQ1
I2-M1-T1-SS3
M3-C1----SQ3
M4]
I1-----CM1
I7-C2-T1-SN3
T3-A1----SM0
M4-A5----SN0

```

Example: resetting outputs and markers

All outputs and markers that you have used can be reset to 0 with one command.

A rising edge at the coil of Z3 will cause all Q and S outputs and all M and N markers to be reset.

Basic circuits

The values in the logic table have the following meanings

For switch contacts:

- 0 = make contact open, break contact closed
- 1 = make contact closed, break contact open

For Q...: relay coils

- 0 = coil not energized
- 1 = coil energized

Negation (contact)

Negation means that the contact opens rather than closes when it is actuated (NOT circuit).

```

I1-----CQ1

```

In the easy circuit diagram, press the **ALT** button to toggle contact I1 between break and make contact.

Table 15: Negation

I1	Q1
1	0
0	1

Negation (coil)

Negation means in this case that the coil opens when the make contact is actuated (NOT circuit).

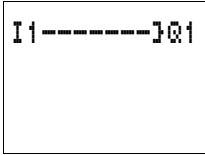

In the easy circuit diagram example, you only change the coil function

Table 16: Negation

I1	Q1
1	0
0	1

Maintained contact

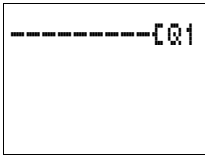

To energize a relay coil continuously, make a connection of all contact fields from the coil to the leftmost position.

Table 17: Maintained contact

---	Q1
...	1

Series circuit

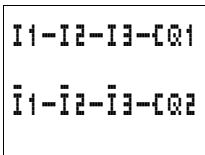

Q1 is controlled by a series circuit consisting of three make contacts (AND circuit).

Q2 is controlled by a series circuit consisting of three break contacts (NOR circuit).

In the easy circuit diagram, you can connect up to three make or break contacts in series within a rung. Use M marker relays if you need to connect more than three make contacts in series.

Table 18: Series circuit

I1	I2	I3	Q1	Q2
0	0	0	0	1
0	0	1	0	0
0	1	0	0	0
0	1	1	0	0
1	0	0	0	0
1	0	1	0	0
1	1	0	0	0
1	1	1	1	0

Parallel circuit

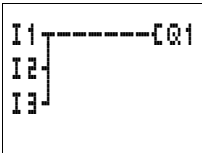

Q1 is controlled by a parallel circuit consisting of several make contacts (OR circuit).

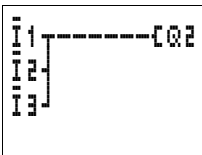

A parallel circuit of break contacts controls Q2 (NAND circuit).

Table 19: Parallel circuit

I1	I2	I3	Q1	Q2
0	0	0	0	1
0	0	1	1	1
0	1	0	1	1
0	1	1	1	1
1	0	0	1	1
1	0	1	1	1
1	1	0	1	1
1	1	1	1	0

Parallel circuit operating like a series connection of make contacts

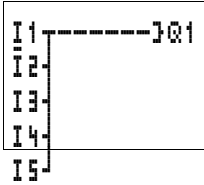

A series circuit with more than three contacts (make contacts) can be implemented with a parallel circuit of break contacts on a negated coil.

In the easy circuit diagram you can switch as many rungs in parallel as you have rungs available.

Table 20: Parallel connection of break contacts on a negated coil

I1	I2	I3	I4	I5	Q1
0	0	0	0	0	0
0	0	0	0	1	0
0	0	0	1	0	0
0	0	0	1	1	0
0	0	1	0	0	0
0	0	1	0	1	0
0	0	1	1	0	0
0	0	1	1	1	0
0	1	0	0	0	0
0	1	0	0	1	0
0	1	0	1	0	0
0	1	0	1	1	0
0	1	1	0	0	0
...	0
...	0
1	1	1	1	1	1

Parallel circuit operating like a series connection of break contacts

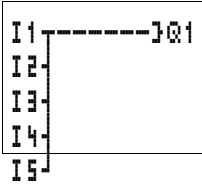

A series circuit with more than three contacts (break contacts) can be implemented with a parallel connection of make contacts on a negated coil.

In the easy circuit diagram you can switch as many rungs in parallel as you have rungs available.

Table 21: Parallel connection of make contacts on a negated coil

I1	I2	I3	I4	I5	Q1
0	0	0	0	0	1
0	0	0	0	1	0
0	0	0	1	0	0
0	0	0	1	1	0
0	0	1	0	0	0
0	0	1	0	1	0
0	0	1	1	0	0
0	0	1	1	1	0
0	1	0	0	0	0
0	1	0	0	1	0
...	0
...	0
1	1	1	1	1	0

Two-way circuit

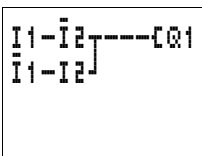

A two-way circuit is made in easy using two series connections that are combined to form a parallel circuit (XOR).

An XOR circuit stands for an “Exclusive Or” circuit. The coil is only energized if one contact is activated.

Table 22: Two-way circuit (XOR)

I1	I2	Q1
0	0	0
0	1	1
1	0	1
1	1	0

Self-latching

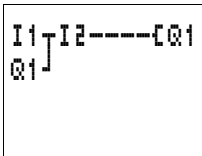

S1 make contact at I1
S2 break contact at I2

A combination of a series and parallel connection is used to wire a latching circuit.

Latching is established by contact Q1 which is connected in parallel to I1. If I1 is actuated and reopened, the current flows via contact Q1 until I2 is actuated.

Table 23: Self-latching

I1	I2	Contact Q1	Coil Q1
0	0	0	0
0	1	0	0
1	0	0	0
1	1	0	1
0	0	1	0
0	1	1	1
1	0	1	0
1	1	1	1

Latching circuits are used to switch machines on and off. The machine is switched on at the input terminals via make contact S1 and is switched off via break contact S2.

S2 breaks the connection to the control voltage in order to switch off the machine. This ensures that the machine can be switched off, even in the event of a wire break. I2 is always closed when not actuated.

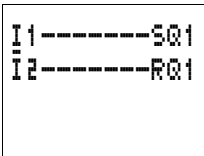

S1 make contact at I1
S2 break contact at I2

A self-latching circuit with wire break monitoring can alternatively be wired using the Set and Reset coil functions.

If I1 is activated, coil Q1 latches. I2 executes the break contact signal from S2 and does not switch until S2 is actuated. In this way, the machine is switched off if or when a wire breaks.

Make sure that both coils are wired up in the correct order in the easy circuit diagram: first wire the S coil and then the R coil. This will ensure that the machine will be switched off when I2 is actuated, even if I1 is switched on.

Impulse relay

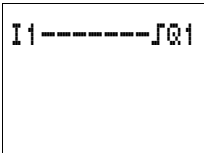

S1 make contact at I1

An impulse relay is often used for controlling lighting such as for stairwell lighting.

Table 24: Impulse relay

I1	Status of Q1	Q1
0	0	0
0	1	1
1	0	1
1	1	0

Cycle pulse on rising edge

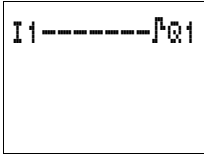

S1 make contact at I1

You can create a cycle pulse on a rising edge if you use the appropriate coil function.

This is very useful for count pulses, jump pulses.

Table 25: Cycle pulse on rising edge

I1	Status of Q1 cycle n	Status of Q1 cycle n + 1
0	0	0
1	1	0
0	0	0

Cycle pulse on falling edge

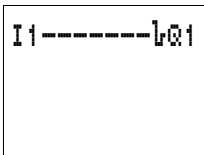

S1 make contact at I1

You can create a cycle pulse on a falling edge if you use the appropriate coil function.

This is very useful for count pulses, jump pulses.

Table 26: Cycle pulse on falling edge

I1	Status of Q1 cycle n	Status of Q1 cycle n + 1
1	0	0
0	1	0
1	0	0

Example circuits

Star-delta starting

You can implement two star-delta circuits with easy. The advantage of easy is that you can select any changeover time between star and delta contactors and any wait time between switching off the star contactor and switching on the delta contactor.

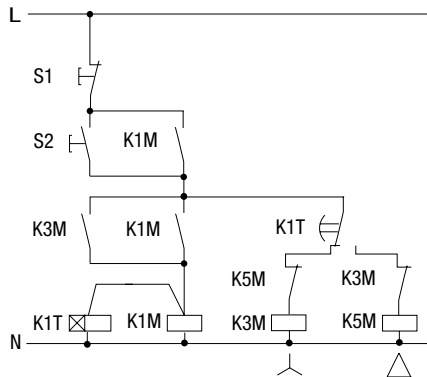

Figure 74: Star-delta circuit with conventional contactors

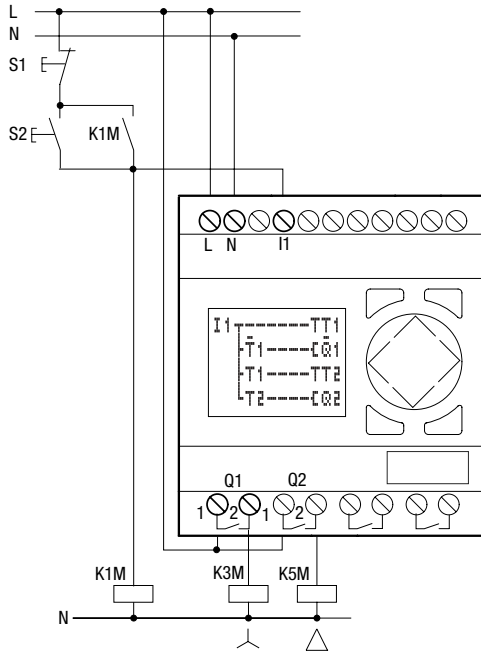
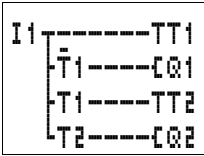

Figure 75: Star-delta circuit with easy



Function of the easy circuit diagram:

Start/stop of the circuit with the external pushbutton actuators S1 and S2. The mains contactor starts the timing relay in easy.

- I1: Mains contactor switched on
- Q1: Star contactor ON
- Q2: Delta contactor ON
- T1: Star-delta changeover time (10 to 30 s, X)
- T2: Wait time between star off, delta on (30, 40, 50, 60 ms, X)

If your easy has an integral time switch, you can combine star-delta starting with the time switch function. In this case, use easy to switch the mains contactor as well.

4x shift register

You can use a shift register for storing an item of information, such as for the sorting of parts into good and bad, for two, three or four transport steps further on.

A shift pulse and the value (0 or 1) to be shifted are needed for the shift register.

The shift register's Reset input is used to clear any values that are no longer needed. The values in the shift register go through the register in the order: 1st, 2nd, 3rd, 4th storage location.

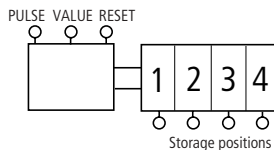

Figure 76: Block diagram of the 4x shift register

Table 27: Shift register

Pulse	Value	Storage position			
		1	2	3	4
1	1	1	0	0	0
2	0	0	1	0	0
3	0	0	0	1	0
4	1	1	0	0	1
5	0	0	1	0	0
Reset = 1		0	0	0	0

Assign the information "bad" to value 0. If the shift register is cleared accidentally, no bad parts are used further.

- I1: Shift pulse (PULSE)
- I2: Information (good/bad) to be shifted (VALUE)
- I3: Clear content of the shift register (RESET)
- M1: 1st storage location
- M2: 2nd storage location
- M3: 3rd storage location
- M4: 4th storage location
- M7: Marker relay for cycle pulse
- M8: Cyclical pulse for shift pulse

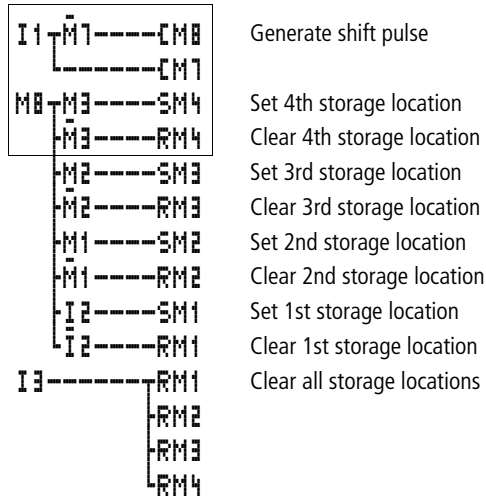

Figure 77: easy circuit diagram shift register

How does the shift register work?

The shift pulse is activated for exactly one cycle. To do this, the shift pulse is generated by evaluating the change from I1 OFF to I1 ON – the rising edge.

In this way, therefore, the cyclical processing of easy is used to trigger the shift pulse.

When I1 is activated for the first time, the marker relay break contact M7 is closed during the first pass through the cycle. Thus, the series circuit consisting of I1, break contact M7 (closed) and M8 is activated. Although M7 is now also activated, this does not yet have any effect on contact M7.

The contact of M8 (make contact) was still open during the first cycle so a shift pulse cannot yet be generated. When the relay coil M8 is activated, easy transfers the result to the contacts.

In the second cycle break contact M7 is open. The series circuit is opened. The contact M8 is activated from the result of the first cycle. Now, all the storage locations are either set or reset in accordance with the series circuit.

If the relay coils were activated, easy transfers the result to the contacts. M8 is now open again. No new pulse can be formed until I1 has opened, since M7 is open for as long as I1 is closed.

How does the value reach the shift register?

When shift pulse M8 = ON, the state of I2 (VALUE) is transferred to storage location M1.

If I2 is activated, M1 is set. If I2 is deactivated, M1 is deactivated via break contact I2.

How is the result shifted?

easy activates the coils in accordance with the rung and its result, from top to bottom. M4 assumes the value of M3 (value 0 or 1) before M3 assumes the value of M2. M3 assumes the value of M2, M2 the value of M1 and M1 the value of I2.

Why are the values not constantly overwritten?

In this example, the coils are controlled only by the S and R functions, i.e. the values are retained in on or off states even though the coil is not constantly activated. The state of the coil changes only if the rung up to the coil is activated. In this circuit, the marker relay is therefore either set or reset. The rungs of the coils (storage locations) are only activated via M8 for one cycle. The result of activating the coils is stored in easy until a new pulse changes the state of the coils.

How are all the storage locations cleared?

When I3 is activated, all the R coils of storage locations M1 to M4 are reset, i.e. the coils are deactivated. Since the reset was entered at the end of the circuit diagram, the reset function has priority over the set function.

How can the value of a storage location be transferred?

Use the make or break contact of storage locations M1 to M4 and wire them to an output relay or in the circuit diagram according to the task required.

Running light

An automatic running light can be created by slightly modifying the shift register circuit.

One relay is always switched on. It starts at Q1, runs through to Q4 and then starts again at Q1.

The marker relays for storage locations M1 to M4 are replaced by relays Q1 to Q4.

T1	⏏	S	+
I1		00.500	
I2		00.500	

The shift pulse I1 has been automated by the flasher relay T1. The cycle pulse M8 remains as it is.

On the first pass, the value is switched on once by break contact M9. If Q1 is set, M9 is switched on. Once Q4 (the last storage location) has been switched on, the value is passed back to Q1.

Try changing the times.

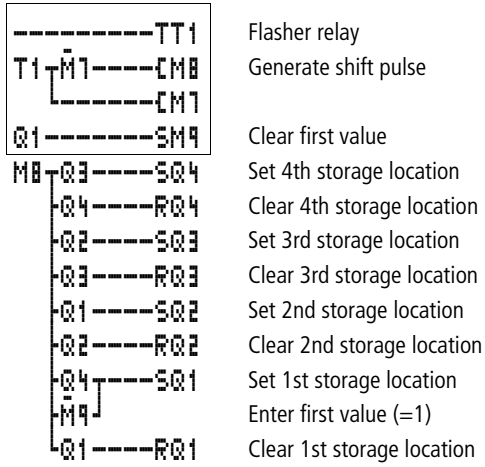

Figure 78: easy run light circuit diagram

Stairwell lighting

For a conventional circuit you would need at least five space units in the distribution board, i.e. one impulse relay, two timing relays and two auxiliary relays.

easy requires only four space units. A fully functioning stairwell lighting system can be set up with five terminals and the easy circuit diagram.

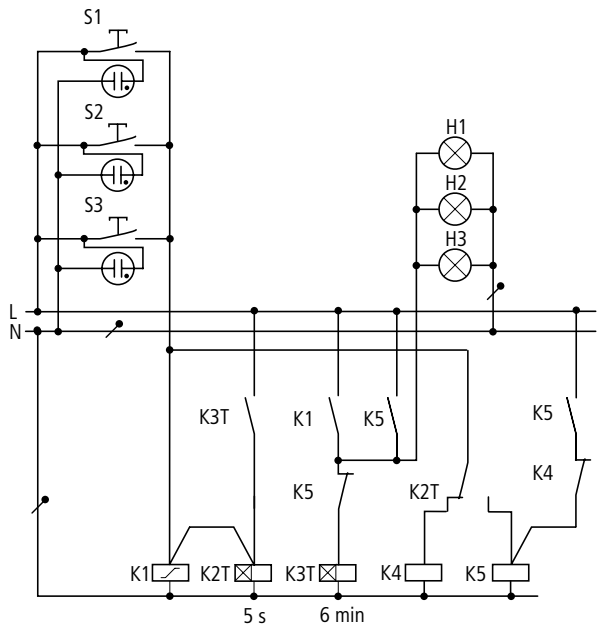

Figure 79: Conventional stairwell lighting



Up to twelve such stairwell circuits can be implemented with one easy device.

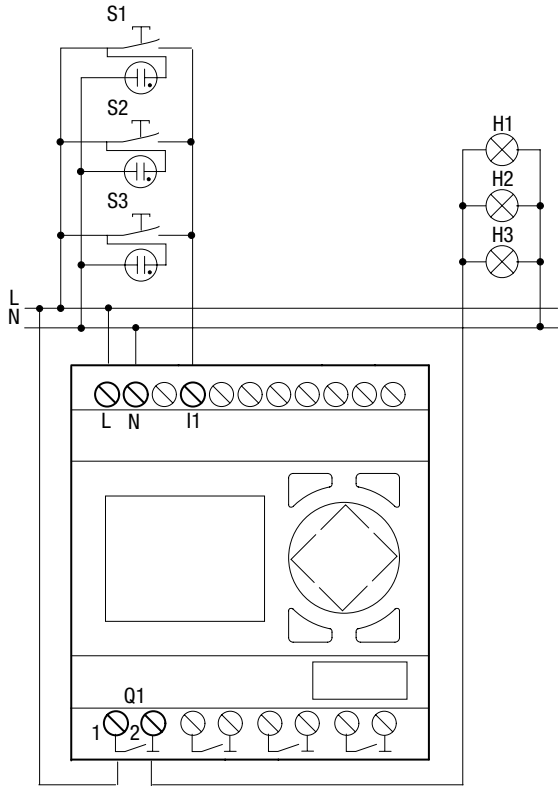
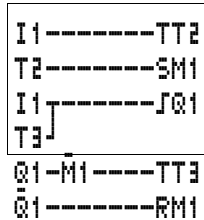

Figure 80: Stairwell lighting with easy

<p>Button pressed briefly</p>	<p>Light ON or OFF. The impulse relay function will even switch off Continuous lighting.</p>
<p>Button pressed for more than 5 s</p>	<p>Light off after 6 min. with Continuous lighting this function is not active.</p>
<p></p>	<p>Continuous lighting</p>

The easy circuit diagram for the functions described above looks like this:



The enhanced easy circuit diagram: after four hours, the continuous lighting is also switched off.

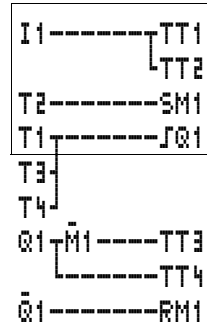

Figure 81: easy circuit diagram stairwell lighting

Meaning of the contacts and relays used:

- I1: ON/OFF pushbutton
- Q1: Output relay for light ON/OFF
- M1: Marker relay. This is used to block the "switch off automatically after 6 minutes" function for continuous lighting.
- T1 Cycle pulse for switching Q1 on and off, (I, single-pulse with value 00.00 s)
- T2 Scan to determine how long the button was pressed. If pressed longer than 5 s, continuous lighting is switched on (X, on-delayed, value 5 s).
- T3 switch off after a lighting time of 6 min. (X, on-delayed, value 6:00 min.).
- T4 Switch off after 4 hours continuous lighting (X, on-delayed, value 4:00 h).

If you are using an easy with a time switch, you can define both the stairwell lighting and the continuous lighting periods via the time switch.

If you use an easy with analog inputs, you can optimise the stairwell lighting with a brightness sensor to suit the lighting conditions.

5 easy Settings

Settings can only be carried out on easy models provided with buttons and LCD display.

EASY-SOFT-BASIC can be used to set all models via the software.

Password protection

The easy can be protected by a password against unauthorised access.

In this case the password consists of a value between 0001 and 9999. The number combination 0000 is used to delete a password.



Factory setting:

0000, no password present and none active, circuit diagram area selected.

Password protection inhibits access to selected areas. The System menu is always protected when a password is activated.

The password can protect the following entries and areas:

- Start or modification of the program
- Transfer of a circuit diagram from and to the memory card
- Change of the RUN or STOP mode.
- Calling and modification of function block parameters
- All settings of the real-time clock.
- Modifications of all system parameters.
- Communication with the individual device.
- Switching off the password delete function.



A password that has been entered in easy is transferred to the memory card together with the circuit diagram, irrespective of whether it was activated or not.

If this easy circuit diagram is loaded back from the memory card, the password will also be transferred to easy and is activated immediately.

Password setup

A password can be set up via the System menu in either RUN or STOP mode. You cannot change to the System menu if a password is already activated.

- ▶ Press **DEL** and **ALT** to call up the System menu.
- ▶ Select the menu option SECURITY... to enter the password.
- ▶ Press the **OK** button and move to the PASSWORD... menu.
- ▶ If you press the **OK** button again, you will access the password entry area.



If no password has been entered, easy changes directly to the password display and displays for XXXX characters: No password present.

- ▶ Press **OK**, four zeros will appear
- ▶ Set the password using the cursor buttons:
 - < > select position in the password,
 - ^ v set a value between 0 to 9.
- ▶ Save the new password by pressing **OK**.

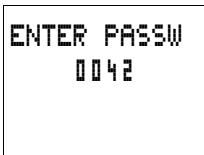

Use **OK** to exit the password display and proceed with **ESC** and v to the RANGE... menu.

The scope of the password has not yet been defined. The password is now valid but not yet activated.

Selecting the scope of the password

```
CIRC DIAG./+
PARAMETER
CLOCK
OPRTNG MODE+
INTERFACE
DELETE FUNCT
```

- ▶ Press the **OK** button.
- ▶ Select the function or the menu to be protected.
- ▶ Press the **OK** button in order to protect the function or menu (tick = protected).



Standard protection encompasses the programs and circuit diagram.

At least one function or menu must be protected.

- **CIRCUIT DIAG:** The password is effective on the program with circuit diagram and non-enabled function relays.
- **PARAMETER:** The PARAMETER menu is protected.
- **CLOCK:** Date and time are protected with the password.
- **OPRTNG MODE:** The toggling of the RUN or STOP operating mode is protected.
- **INTERFACE:** The interface is disabled for access with EASY-SOFT (-BASIC, -PRO).
- **DELETE FUNCT:** The question DELETE PROG? will appear on the device after four incorrect password entries have been made. This prompt is not displayed if selected. However, it is no longer possible to make changes in protected areas if you forget the password.

Activating the password

You can activate a valid password in three different ways:

- automatically when easy is switched on again
- automatically after a protected circuit diagram is loaded
- via the password menu

- ▶ Press **DEL** and **ALT** to call up the System menu.
- ▶ Open the password menu via the SECURITY... menu

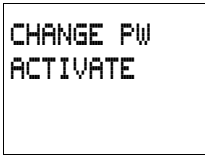

easy will only show this menu if a password is present.



Make a note of the password before you activate it. If the password is no longer known, easy can be unlocked (DELETE FUNCT is not active), but the circuit diagram and data settings are lost. The interface must not be disabled.



Attention!

If the password is unknown or lost, and the password delete function is not activated: The unit can only be reset to the factory setting by the manufacturer. The program and all data are lost.

- ▶ Select **ACTIVATE PW** and press **OK**.

The password is now active. easy changes back automatically to the Status display.

You must unlock easy with the password before you carry out a protected function, enter a protected menu or the System menu.

Unlocking easy

Unlocking easy will deactivate the password. You can reactivate password protection later via the Password menu or by switching the power supply off and on again.

- ▶ Press **OK** to switch to the main menu.

The PASSWORD... entry will flash.

- ▶ Press **OK** to enter the password entry menu.

```
PASSWORD...
STOP RUN ✓
PASSWORD...
INFO
```



If easy shows PROGRAM... in the main menu instead of PASSWORD..., this means that there is no password protection active.

```
ENTER PASSW
XXXX
```

easy will display the password entry field.

- ▶ Set the password using the cursor buttons:
- ▶ Confirm with **OK**.

If the password is correct, easy will switch automatically to the Status display.

```
PROGRAM...
STOP
PARAMETER
INFO
```

The PROGRAM... menu option is now accessible so that you can edit your circuit diagram.

The System menu is also accessible.

Changing or deleting the password range

- ▶ Unlock easy.
- ▶ Press **DEL** and **ALT** to call up the System menu.
- ▶ Open the password menu via the menu option SECURITY → PASSWORD...

```
CHANGE PW
ACTIVATE PW
```

The CHANGE PW entry will flash.

easy will only show this menu if a password is present.



- ▶ Press **OK** to enter the password entry menu.
- ▶ Press **OK** to move to the 4-digit entry field.
- ▶ Four zeros will be displayed

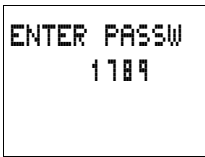

- ▶ Modify the four password digits using the cursor buttons.
- ▶ Confirm with **OK**.

Press **ESC** to exit the security area.

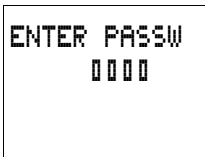

Deleting

Use number combination 0000 to delete a password.

If a password has not been entered already, easy will show four XXXX.

Password incorrect or no longer known

If you no longer know the exact password, you can try to re-enter the password several times.



The DELETE FUNCT function has not been deactivated.



Have you entered an incorrect password?

- ▶ Re-enter the password.



After the fourth entry attempt easy will ask whether you wish to delete the circuit diagram and data.

- ▶ Press
 - **ESC**: Circuit diagram, data or password are not deleted.
 - **OK**: Circuit diagram, data and password are deleted.

easy will return to the Status display.



If you no longer know the exact password, you can press **OK** to unlock the protected easy. The saved circuit diagram and all function relay parameters will be lost.

Pressing **ESC** will retain the circuit diagram and data. You can then make another four attempts to enter the password.

Changing the menu language

easy500 and easy700 provide twelve menu languages which are set as required via the System menu.

Language	LCD display
English	ENGLISH
German	DEUTSCH
French	FRANCAIS
Spanish	ESPAÑOL
Italian	ITALIANO
Portuguese	PORTUGUES
Dutch	NETERLANDS
Swedish	SVENSKA
Polish	POLSKI
Turkish	TURKCE
Czech	CESKY
Hungarian	MAGYAR



Language selection is only possible if easy is not password-protected.

- ▶ Press **DEL** and **ALT** to call up the System menu.
- ▶ Select LANGUAGE... to change the menu language.



The language selection for the first entry ENGLISH is displayed.

- ▶ Use ^ or v to select the new menu language, e.g. Italian (ITALIANO).
- ▶ Confirm with **OK**. ITALIANO is assigned a tick.
- ▶ Exit the menu with **ESC**.

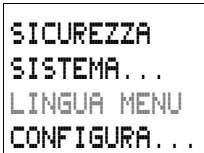

easy will now show the new menu language.

Press **ESC** to return to the Status display.

Changing parameters

easy allows you to change function relay parameters such as timing relay setpoint values and counter setpoints without having to call up the circuit diagram. This is possible regardless of whether easy is running a program or is in STOP mode.

- ▶ Press **OK** to switch to the main menu.
- ▶ Start the parameter display by selecting **PARAMETER**.

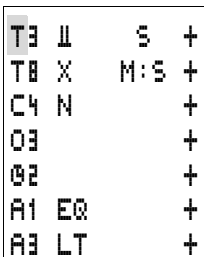

All function relays are displayed as a list.

The following preconditions must be fulfilled in order for a parameter set to be displayed:

- A function relay must have been included in the circuit diagram.

- The PARAMETER menu must be available.
- The parameter set must have been enabled for access, indicated by the + character at the bottom right of the display.



You can enable or disable parameter access using the “+” or “-” parameter set characters respectively in the circuit diagram.

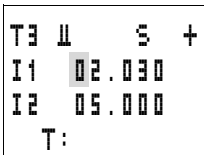

- ▶ Select the required function block with \wedge or \vee .
- ▶ Press the **OK** button.
- ▶ Use the cursor buttons \wedge or \vee to select the parameter required.
- ▶ Change the values for a parameter set:
 - Press **OK** to enter the Entry mode.
 - Press $\langle \rangle$ to change decimal place
 - Press $\wedge \vee$ to change the value of a decimal place
 - Press **OK** to save constants or
 - Press **ESC** to retain previous setting.

Press **ESC** to leave the parameter display.

Adjustable parameters for function relays

You can also modify the function relay parameters used in the circuit diagram in the PARAMETER menu.

Adjustable setpoint values are:

- With all function relays the setpoints
- On and off times with time switches.

In RUN mode easy operates with a new setpoint as soon as it has been modified in the parameter display and saved with **OK**.

Example: Changing switch times for outdoor lighting

The outdoor lighting of a building is automatically switched on from 19:00 to 23:30 Mondays to Fridays in the easy circuit diagram.

```

01 A 15:21 +
D   MO-FR
ON  19:00
OFF 22:30

```

The parameter set for the time switch function relay 1 is saved in channel A and looks like this.

From the following weekend, the outdoor lighting is now also required to switch on between 19:00 and 22:00 on Saturdays.

- ▶ Select **PARAMETER** from the main menu.

The first parameter set is displayed.

- ▶ Use \wedge or \vee to scroll through the parameter sets until channel A of time switch 1 is displayed.
- ▶ Press \wedge to select the next empty parameter set, in this case channel B of time switch 1.

```

01 B 15:21 +
D   --
ON  00:00
OFF 00:00

```

The current time is 15:21.

- ▶ Change the value for the day interval from MO to SA:
 - $\langle \rangle$ Move between the parameters
 - $\wedge \vee$ Change value.
- ▶ Press **OK** to acknowledge the value SA.

```

01 B 15:21 +
D   SA
ON  00:00
OFF 00:00

```

- ▶ Change the ON value to 19:00.
- ▶ Move to the value of ON
- ▶ Press **OK**.
 - $\langle \rangle$ Move between the parameters
 - $\wedge \vee$ Change value.
- ▶ Press **OK** to acknowledge the value 19:00.

```

01 B 15:21 +
D   SA
ON  19:00
OFF 00:00

```

- ▶ Set the switching off time to 22:00.
- ▶ Press **OK**.

```

01 B 15:21 +
D   SA
ON  19:00
OFF 22:00

```

easy will save the new parameters. The cursor will remain in the contact field on channel identifier B.

Press **ESC** to leave the parameter display.

The time switch will now also switch on at 19:00 on Saturdays and switch off at 22:00.

Setting date, time and daylight saving time

The easy500 and easy700 devices are equipped with a real-time clock with date and time functions. The type reference is EASY...-...C. The time switch function relays can thus be used to implement time switch applications.



Factory setting:

SA 0:01 01.05.2004

Setting the time

If the clock has not yet been set or if the device is switched on after the buffer time has elapsed, the clock starts with the setting "SA 0:01 01.05.2004". The easy clock operates with date and time so the hour, minute, day, month and year must all be set.

- ▶ Select SET CLOCK... from the main menu.

This will open the menu for setting the time.

- ▶ Select SET CLOCK and confirm with **OK**.

```
SET CLOCK
SUMMER TIME
```

```
HH:MM: 18:24
DD.MM: 01.05
YEAR : 2004
```

- ▶ Set the values for time, day, month and year.
- ▶ Press the **OK** button to access the Entry mode.
 - < > Move between the parameters
 - ^ v Change the value of a parameter
 - **OK** Save day and time
 - **ESC** Retain previous setting.

Press **ESC** to leave the time setting display.

Setting summer time start and end

Most easy models are fitted with a real-time clock. The clock has various possibilities for starting and ending the summer time (DST) setting. These are subject to different legal requirements in the EU, GB and USA.



Factory setting:

No automatic DST setting present

You can make the following settings:

- NONE: no DST setting rule.
- RULE: a user-defined date for the DST change
- EU: date defined by the European Union; Start: last Sunday in March; End: last Sunday in October;
- GB: date defined in Great Britain; Start: last Sunday in March; End: fourth Sunday in October.
- US: date defined in the United States of America: Start: first Sunday in April; End: last Sunday in October.

The following applies to all legally stipulated DST settings:

Summer time start: On the day of time change, the clock moves forward one hour at 2:00 to 3:00.

Summer time end: On the day of time change, the clock moves back one hour at 3:00 to 2:00.

Select SET CLOCK... from the main menu.

This will open the menu for setting the time.

▶ Select the SUMMER TIME menu option.



Setting summer time start and end

easy shows you the options for the DST change.

The standard setting is NONE for automatic DST changeover (Tick at NONE).



The start and end of summer time can only be set in STOP mode.

NONE	/+
RULE...	
EU	
GB	+
US	

► Select the required DST version and press the **OK** button.

NONE	+
RULE...	
EU	/
GB	+
US	

The rule for the European Union (EU) has been selected.

Summer time start and end, setting the rule

If you wish to enter your own date, it is important to know what settings are possible.

The start and end of summer time is a complex calculation procedure throughout the world. For this reason, the standard rules for the EU, US, GB are provided in easy.

The following rules normally apply:

Table 28: DST setting rule

When ON	Weekday WD	How	Date
Rule 1: change on a special date			
--	--	--	→ table 29
Rule 2: change on a defined day in the month			
<ul style="list-style-type: none"> • 1st (first) • 2nd (second) • 3rd (third) • 4th (fourth) • L. (last) 	<ul style="list-style-type: none"> • SU (Sunday) • MO (Monday) • TU (Tuesday) • WE (Wednesday) • TH (Thursday) • FR (Friday) • SA (Saturday) 	MONTH	→ table 29 ¹⁾
Rule 3: change on a defined day after or before a date			
1st (first)	<ul style="list-style-type: none"> • SU (Sunday) • MO (Monday) • TU (Tuesday) • WE (Wednesday) • TH (Thursday) • FR (Friday) • SA (Saturday) 	<ul style="list-style-type: none"> • AFTER THE • BEFORE THE 	→ table 29

1) Apart from day definitions

Table 29: Date parameters

Day	Month	Hour	Minute	Time difference
DD.	MM	HH:	MM	H:M
• 1st	• 1 (January)	• 00	• 00	• + 3:00
• 2nd	• 2 (February)	• 01	• 01	• + 2:30
• ...	• ...	• 02	• 02	• + 2:00
• 31st	• 12 (December)	• 03	• 03	• + 1:30
		• ...	• 04	• + 1:00
		• 23	• ...	• + 0:30
			• 59	• - 0:30
				• - 1:00
				• - 1:30
				• - 2:00
				• - 2:30
				• - 3:00

Example with EU (European Union)

End of summer time

Menu in easy SUMMER END:

The following rule applies:

The clock goes back one hour (-1:00) to 2:00 at 3:00 on the last Sunday in October.

Table 30: EU summer time end

When	Weekday	How	Day	Month	Hour	Minute	Time difference
	WD		DD.	MM	HH:	MM	H:M
ON L. (last)	SU (Sunday)	MONTH	--	10 (October)	03	00	- 1:00

Start of summer time

Menu in easy SUMMER START:

The following rule applies:

The clock goes forward one hour (+1:00) to 3:00 at 2:00 on the last Sunday in March.

Table 31: EU summer time start

When	Weekday	How	Day	Month	Hour	Minute	Time difference
			DD.	MM	HH:	MM	H:M
ON L. (last)	SU (Sunday)	MONTH	--	03 (March)	02	00	+ 1:00

The following start and times for summer time normally apply throughout the world (as at beginning of 2004):

Table 32: Summer time rules

Country/ Region	Summer time start	Summer time end	Start time ¹⁾	End time ²⁾
Brazil, Rio de Janeiro	1st Sunday in November	1st Sunday after the 15th February	00:00	00:00
Chile, Santiago	1st Sunday after 8th October	1st Sunday after 8th March	00:00	00:00
USA/Antarctic, McMurdo	1st Sunday in October	1st Sunday after 15th March	02:00	02:00
Chatham Islands	1st Sunday in October	1st Sunday after 15th March	02:45	03:45
New Zealand	1st Sunday in October	1st Sunday after 15th March	02:00	03:00
Chile, Easter Islands	1st Saturday after 8th October	1st Saturday after 8th March	22:00	22:00
USA/Antarctic, Palmer	1st Sunday after 9th October	1st Sunday after 9th March	00:00	00:00
Iran ³⁾	1st day of Favaridin	30th day of Shahrivar	00:00	00:00
Jordan	Last Thursday in March	Last Thursday in September	00:00	01:00
Israel	Special rules according to the Hebrew calendar		01:00	01:00
Australia, Howe Islands	Last Sunday in October	Last Sunday in March	02:00 ⁴⁾	02:00

Country/ Region	Summer time start	Summer time end	Start time ¹⁾	End time ²⁾
Australia	Last Sunday in October	Last Sunday in March	02:00	03:00
Georgia	Last Sunday in March	Last Sunday in October	00:00	00:00
Azerbaijan	Last Sunday in March	Last Sunday in October	01:00	01:00
Kirgistan	Last Sunday in March	Last Sunday in October	02:30	02:30
Syria	1st April	1st October	00:00	00:00
Iraq	1st April	1st October	03:00	04:00
Pakistan	1st Sunday after the 2nd April	1st Saturday in October	00:00	00:00
Namibia	1st Sunday in September	1st Sunday in April	02:00	02:00
Paraguay	1st Sunday in September	1st Sunday in April	02:00	00:00
Canada, Newfoundland	1st Sunday in April	Last Sunday in October	00:01	00:01

- 1) Relevant local time to which the clock should be set forward.
- 2) Relevant local time to which the clock should be set back.
- 3) Persian calendar
- 4) Summer time = standard time + 0.5 hours

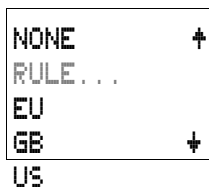

- ▶ Select the **RULE** menu.
- ▶ Press the **OK** button.



The two SUMMER START (start of summer time) and SUMMER END (end of summer time) menus are shown.

SUMMER START: set the DST time for the start of summer.

SUMMER END: set the DST time for the end of summer.



If a standard rule has been selected, this will be accepted as the rule.

This menu appears for entering the required time settings:

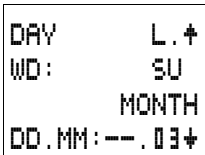

DAY L. + — Rule for day, 1st, 2nd, 3rd, 4th, Lst.

WD: SU — Weekday

MONTH — Rule 2 MONTH, AFTER, BEFORE

DD.MM: --.03+ — Date, day, month

HH:MM: 02:00 — Time, hour, minute

DIFF: +1:00 — Time difference, summer time always + x:xx
Time difference, winter time always - x:xx

Enter summer time start.



► Press **OK** to reach Entry mode for the summer time start rule.

The following menu appears:

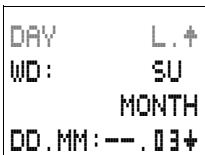

This will open the menu for setting the time.

► Set the values for DST time change.

- ▶ Press the **OK** button to access the Entry mode.
 - $\wedge \vee$ Select required value.
 - $\langle \rangle$ Move between the places.
 - $\wedge \vee$ Change the value of a parameter
 - **OK** Save value.
 - **ESC** Retain previous setting.

Press **ESC** to leave the DST setting display.

The above rule is the EU rule for the start of summer time.



The menu for the end of summer time has the same structure. The values are now entered accordingly.



The DIFF time difference value can be modified both for the summer time setting and the winter time setting. The value is always the same.

Summer time means a positive value + X:XX.

Winter time means a negative value – X:XX.



Behaviour on 29 February

If the time change is set for 29.02. at HH.MM, the switch time for years that are not leap years will occur on 01.03 at HH.MM.

The switch time minus the time difference should not go into 28.02. The following applies:

0:15 is put back by –30 min. New time: 28.02. 23:45



Behaviour for summer time end on 01.01.

If 01.01. is selected for the end of summer time, ensure the following:

The DST time minus the time difference should not go into 31.12. Otherwise the time will continue to run until the set time minus the time difference is 0:00 on the 01.01. The time will then continue to run with 0:00.



Setting the time manually within the summer time end setting:

At 3:00 on summer time end the time is to be put back by one hour to 2:00.

The clock is set at 1:30 to 3:05. easy will interpret this as 3:05 winter time. A time change will not be carried out.

Activating debounce (input delay)

Input signals can be evaluated by easy with an input delay. This enables, for example, the trouble-free evaluation of switches and pushbutton actuators subject to contact bounce.



Factory setting:

Debounce is activated.

High-speed counter functions are evaluated independently of the debounce function.

In many applications, however, very short input signals have to be monitored. In this case, the debounce function can be switched off.

- ▶ Press **DEL** and **ALT** to call up the System menu.
- ▶ Select the **SYSTEM** menu.



If easy is password-protected you cannot open the System menu until you have "unlocked" it.

```
DEBOUNCE  †
P BUTTONS
RUN MODE
CARD MODE  †
```

The input delay (debounce) is set with the DEBOUNCE menu item.

```
DEBOUNCE  ✓†
P BUTTONS
RUN MODE
CARD MODE  †
```

Activating debounce (input delay)

If a tick ✓ is next to **DEBOUNCE**; this means that the Debounce function has been switched on.

If this is not so, proceed as follows:

- ▶ Select **DEBOUNCE** and press **OK**.

Debounce mode will be activated and the display will show **DEBOUNCE ✓**.

Press **ESC** to return to the Status display.

Deactivating debounce (input delay)

If easy is showing **DEBOUNCE** in the display, this means that Debounce mode has already been deactivated.

- ▶ Otherwise select **DEBOUNCE ✓** and press **OK**.

If Debounce mode is deactivated the display will show **DEBOUNCE**.



How easy input and output signals are processed internally is explained in section "Delay times for inputs and outputs", from page 238.

Activating and deactivating the P buttons

Even though the cursor buttons (P buttons) have been set as pushbutton actuator inputs in the circuit diagram, this function is not activated automatically. This prevents any unauthorised use of the cursor buttons. The P buttons can be activated in the System menu.



If easy is password-protected you cannot open the System menu until you have "unlocked" it.



Factory setting:
The P buttons are not activated.

The P buttons are activated and deactivated via the P BUTTONS menu.

```
DEBOUNCE  ✓+
P BUTTONS
RUN MODE
CARD MODE  +
```

- ▶ Press **DEL** and **ALT** to call up the System menu.
- ▶ Select the SYSTEM menu.
- ▶ Move the cursor to the P BUTTONS menu.

```
DEBOUNCE  ✓+
P BUTTONS  ✓
RUN MODE
CARD MODE  +
```

Activating the P buttons

If easy is displaying **P BUTTONS** ✓, this means that the P buttons are active.

- ▶ Otherwise select P BUTTONS and press **OK**.
easy changes the display to **P BUTTONS** ✓ and the P buttons are activated.
- ▶ Press **ESC** to return to the Status display.

Function of the P buttons

The P buttons are only active in the Status display. In this display you can use the P buttons to activate inputs in your circuit diagram.



If a text is displayed, the P buttons only function if a value entry is not carried out.

Deactivating the P buttons

► Select **P BUTTONS**  and press **OK**.

easy changes the display to **P BUTTONS** and the P buttons are deactivated.



When deleting a circuit diagram in easy500, the P buttons are deactivated automatically. If a circuit diagram is loaded from the memory card or from EASY-SOFT-BASIC, the status set there is also transferred.

Startup behaviour

The startup behaviour is an important aid during the commissioning phase. The circuit diagram which easy contains is not yet fully wired up, or the system or machine is in a state which easy is not permitted to control. The outputs should not be controlled when easy is switched on.

Setting the startup behaviour



The easy models without a display can only be started in RUN mode.

Requirement: easy must contain a valid circuit diagram.



Factory setting:
RUN mode is activated.

Switch to the System menu.



If easy is password-protected, the System menu can only be accessed after easy has first been "unlocked" (→ section "Unlocking easy", from page 207).

Specify the operating mode which easy must use when the power supply is switched on.

Activating RUN mode

Displayed as easy **RUNMODE** ✓, this means that easy will start in RUN mode when the power supply is switched on.

```
DEBOUNCE  ✓+
P BUTTONS
RUN MODE  ✓
CARD MODE  +
```

► Otherwise select RUN MODE and press **OK**.

RUN mode is activated.

► Press **ESC** to return to the Status display.

```
DEBOUNCE  ✓+
P BUTTONS
RUNMODE    ✓
CARD MODE  +
```

Deactivating RUN mode

► Select **RUN MODE** ✓. Press the **OK** button.

The RUN mode function is deactivated.

easy is factory set with the display showing **RUN MODE** ✓, which means that easy starts in RUN mode when the power supply is switched on.

Table 33: Startup behaviour

Startup behaviour	Menu displayed	Status of easy after startup
easy starts in STOP mode	RUN MODE	easy is in STOP mode
easy starts in RUN mode	RUN MODE ✓	easy is in RUN mode

Behaviour when the circuit diagram is deleted

The setting for the startup behaviour is an easy device function. When the circuit diagram is deleted this does not result in the loss of the setting selected.

Behaviour during upload/download to card or PC

When a valid circuit diagram is transferred from easy to a memory card or the PC or vice versa, the setting is still retained.



The easy models without a display can only be started in RUN mode.

Possible faults

easy will not start in RUN mode:

- easy does not contain a program.
- You have put easy in STOP mode (RUN MODE menu displayed).

Card mode behaviour

The startup behaviour using a memory card is for applications where unskilled personnel have to change the memory card with easy de-energized.

easy only starts in the RUN mode if a memory card with a valid program is inserted.

If the program on the memory card is different to the program in easy, the program from the card is loaded into easy and easy starts in RUN mode.



Factory setting:

Card mode is not activated.

- ▶ Switch to the System menu.



If easy is password-protected, the System menu can only be accessed after easy has first been "unlocked" (→ section "Unlocking easy", from page 207).

Activation of card mode

Displayed in easy as **CARD MODE** ✓, this means that when the power supply is switched on, easy will only start in RUN mode if a memory card with a valid program has been inserted.

```
DEBOUNCE  ✓+
P BUTTONS
RUN MODE  ✓
CARD MODE ✓+
```

▶ Otherwise select **CARD MODE** and press the **OK** button.

easy will start up with the program on the card.

▶ Press **ESC** to return to the Status display.



Card mode only functions with the EASY-M-32K memory card. Previous EASY-M-8K or EASY-M-16K memory cards did not support this function.

```
DEBOUNCE  ✓+
P BUTTONS
RUN MODE  ✓
CARD MODE  +
```

Deactivating card mode

▶ Select **CARD MODE** ✓ and press the **OK** button.

The Card mode function is deactivated.

easy is factory set with the display showing **CARD MODE**, which means that easy without a memory card starts in RUN mode when the supply voltage is applied.

Setting the cycle time

easy allows you to fix the cycle time. To do this, move to the SYSTEM menu and from there to the CYCLE TIME.. menu



Factory setting:

The cycle time is set to 00 ms.

```
P BUTTONS  ↑
RUN MODE   ✓
CARD MODE  ✓
CYCLE TIME ↓
```

The cycle time can only be set in STOP mode.

easy is in STOP mode.

▶ Select CYCLE TIME and press **OK**.

The following menu appears:

```
CYCLE TIME
      00 MS
```

▶ Press **OK**.

You can now enter the set cycle time.

- < > Move between the parameters

- ^ ^ Change value.

▶ Press **OK** to acknowledge the value: e.g. 35 ms.

```
CYCLE TIME
      35 MS
```

The minimum set cycle time is 35 ms. The cycle time can be lengthened if easy requires more time to process the program.



The entry of a set cycle time is only useful in applications involving two-step controllers or similar functions.

With a cycle time setting of 00 ms, easy will process the circuit diagram and the program at the fastest possible speed. (see also inside easy.. Cycle time)

Set cycle time value range:

between 00 and 60 ms.

Retention (non-volatile data storage)

It is a requirement of system and machine controllers for operating states or actual values to have retentive settings. What this means is that the values will be retained safely even after the supply voltage to a machine or system has been switched off, and will also be retained until the next time the actual value is overwritten.



Factory setting:
The retention function is not activated.

Permissible markers and function relays

It is possible to retentively store (non-volatile memory) the actual values (status) of markers, timing relays and up/down counters.

The following markers and function relays can be set to have retentive actual values:

- Markers M9 to M12, M13 to M16, N9 to N16
- Up/down counters: C5, C6, C7, C8, C13 to C16
- Text function relays: D1 to D8
- Timing relays: T7, T8, T13 to T16



To ensure that easy500 and easy700 are fully compatible with easy400 and easy600 devices, the retentive data settings were divided into the above areas.



Attention!

The retentive data is kept every time the power supply is switched off. Data security is assured for 1 000 000 write cycles.

Setting retentive behaviour

Requirement: easy must be in STOP mode.

- ▶ Switch to the System menu.



If easy is password-protected, the System menu can only be accessed after easy has first been "unlocked" (→ section "Unlocking easy", from page 207).

```
RUN MODE  ✓+
CARD MODE
CYCLE TIME.
RETENTION...+
```

- ▶ Switch to STOP mode.
- ▶ Switch to the System menu.
- ▶ Move to the SYSTEM menu and continue to the RETENTION... menu.
- ▶ Press the **OK** button.

```
M 9 - M12 ✓+
M13 - M16
N 9 - N16
C 5 - C 7 ✓+
```

The first screen display is the selection of the marker range.

- ▶ ^v Select a range.
- ▶ Press **OK** to select the marker, the function relay or the range that is to be retentive (tick on the line).

```
C 8 ✓
C13 - C16
D 1 - D 8
T1
T8
T13 - T16
```

Press **ESC** to exit the entry for the retentive ranges.

```
M 9 - M12 ✓+
M13 - M16
N 9 - N16
C 5 - C 7 ✓+
```

Example:

M9 to M12, counters C5 to C7, C8 as well as timing relays T7 and T8 are retentive. Indicated by the tick on the line.

The default setting of easy is selected so that no retentive data is selected. In this setting, easy works without retentive actual values if a valid circuit diagram is present. When easy is in STOP mode or has been switched to a de-energized state, all actual values are cleared.

```
C 8 ✓
C13 - C16
D 1 - D 8
T 7 ✓
T 8 ✓
T13 - T16
```

Deleting retentive actual values

The retentive actual values are cleared if the following is fulfilled (applies only in STOP mode):

- When the circuit diagram is transferred from EASY-SOFT-BASIC or the memory card to the easy control relay, the retentive actual values are reset to 0. This also applies when there is no program on the memory card. In this case the old circuit diagram is retained in easy.
- When the selected retentive markers, function relays or text display are deactivated.
- When the circuit diagram is deleted via the DELETE FUNCT menu.

The operating hours counters are always retentive. The actual values can only be reset by means of a special reset operation from the circuit diagram.

Transferring retentive behaviour

The setting for retentive behaviour is a circuit diagram setting; in other words, the retention setting is on the memory and is transferred with the circuit diagram when uploading or downloading from the PC.

Changing the operating mode or the circuit diagram

When the operating mode is changed or the easy circuit diagram is modified, the retentive data is normally saved together with their actual values. The actual values of relays no longer being used are also retained.

Changing the operating mode

If you change from RUN to STOP and then back to RUN, the actual values of the retentive data will be retained.

Modifying the easy circuit diagram

If a modification is made to the easy circuit diagram, the actual values will be retained.



Attention!

Even if the markers and function relays that were retentive are deleted from the circuit diagram, the retentive actual values remain when changing from STOP to RUN, and when switching the device off and on. Should these relays be used again in the circuit diagram, they will still have their former actual values.

Changing the startup behaviour in the SYSTEM menu

The retentive actual values in easy will be retained irrespective of the RUN MODE or STOP MODE settings.

Displaying device information

Device information is provided for service tasks and for determining the capability of the device concerned.

This function is only available with devices featuring a display.

Exception: Terminal mode with the MFD-Titan.

easy enables the display of the following device information:

- AC, AB (AC voltage) or DA, DC (DC voltage),
- T (transistor output) or R (relay output)
- C (clock provided)
- LCD (display provided)
- OS: 1.10.204 (operating system version)
- CRC: 25825 (Checksum of the operating system is only displayed in STOP mode).
- Program name if this was assigned in EASY-SOFT-BASIC.

► Switch to the main menu.



The device information is always available. The password does not prevent access.

```
PROGRAM... +
STOP / RUN
PARAMETER...
INFO... +
SET CLOCK..
```

- Select the main menu.
- Use the ∨ cursor button to select the INFO... menu
- Press the **OK** button.

```
DC TC LCD
OS: 1.00.027
CRC: 02752
PROGRAM_0815
```

This will display all device information.

Press **ESC** to exit the display.

6 Inside easy

easy circuit diagram cycle In conventional control systems, a relay or contactor control processes all the rungs in parallel. The speed with which a contactor switches in this case depends on the components used, and ranges from 15 to 40 ms for relay pick-up and drop-out.

With easy the circuit diagram is processed with a microprocessor that simulates the contacts and relays of the circuit concerned and thus processes all switching operations considerably faster. Depending on its size, the easy circuit diagram is processed cyclically every 2 to 40 ms.

During this time, easy passes through five segments in succession.

How easy evaluates the circuit diagram:

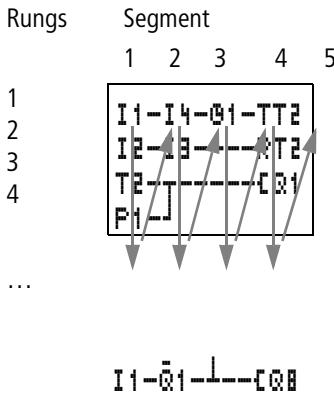

In the first three segments easy evaluates the contact fields in succession. As it does so, easy also checks whether the contacts are connected in parallel or series and stores the switching states of all the contact fields.

In the fourth segment, easy assigns the new switching states to all the coils in one pass.

The fifth segment is outside the circuit diagram and easy uses it to establish contact to the "outside world": The output relays Q1 to Q... are switched and inputs I1 to I.. are read again. easy also copies all the new switching states to the status image register.

easy only uses this status image for one cycle. This ensures that each rung is evaluated with the same switching states for one cycle, even if the input signals at I1 to I12, for example, change their status several times within a cycle.

Evaluation in the circuit diagram and high-speed counter functions

When using high-speed counter functions, the signal state is continuously counted or measured irrespective of the processing of the circuit diagram. (C13, C14 high-speed up/down counters, C15, C16 frequency counters)

easy operation and effects on circuit diagram creation

easy evaluates the circuit diagram in these five segments in succession. You should therefore remember two points when you create your circuit diagrams:

- The changeover of a relay coil does not change the switching state of an associated contact until the next cycle starts.
- Always wire forwards, upwards or downwards. Never wire backwards.

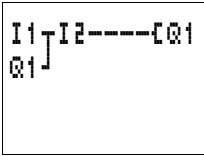

Example: switching in the next cycle

Start condition:

- I1, I2 switched on
- Q1 switched off.

This is the circuit diagram of a self-latching circuit. If I1 and I2 are closed, the switching state of relay coil CQ1 is latched via contact Q1.

- **1st cycle:** Inputs I1 and I2 are switched on. Coil CQ1 picks up.
- Contact Q1 remains switched off since easy evaluates from left to right.
- **2nd cycle:** The self-latching function now becomes active. easy has transferred the coil states to contact Q1 at the end of the first cycle.

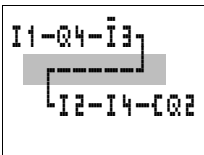

Example: Do not wire backwards

This example is shown in section “Creating and modifying connections”. It was used there to illustrate how NOT to do it.

In the third rung, easy finds a connection to the second rung in which the first contact field is empty. The output relay is not switched.

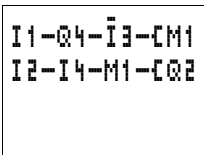

When wiring more than three contacts in series, use one of the marker relays.

Delay times for inputs and outputs

The time from reading the inputs and outputs to switching contacts in the circuit diagram can be set in easy via the delay time.

This function is useful, for example, in order to ensure a clean switching signal despite contact bounce.

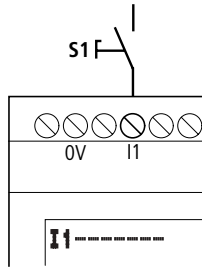

Figure 82: easy input assigned with a switch

easy-DC, easy-DA, easy-AB and easy-AC units function with different input voltages and therefore also have different evaluation characteristics and delay times.

Delay times with easy-DA and easy-DC basic units

The delay time for DC signals is 20 ms.

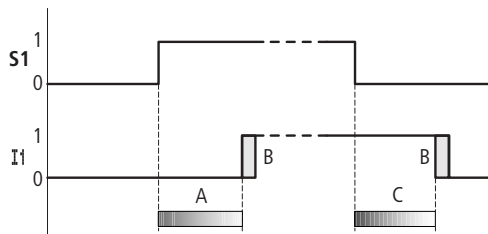

Figure 83: Delay times of easy-DC and easy-DA basic units

An input signal S1 must therefore be 15 V or 8 V (easy-DA) for at least 20 ms on the input terminal before the switch contact will change from 0 to 1 (range A). If applicable, this time must also include the cycle time (range B) since easy does not detect the signal until the start of a cycle.

The same time delay (range C) applies when the signal drops out from 1 to 0.

If the debounce is switched off, easy responds to an input signal after just 0.25 ms.

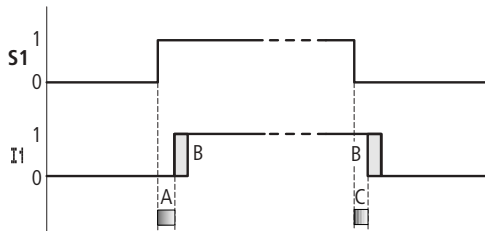

Figure 84: Switching behaviour with input debounce disabled

Typical delay times with the debounce delay switched off are:

- On delay for I1 to I12:
 - 0.25 ms (DC),
 - 0.3 ms (easy-DA)
- Off delay for
 - I1 to I6 and I9 to I12: 0.4 ms (easy-DC), 0.3 ms (easy-DA)
 - I7 and I8: 0.2 ms (DC), 0.35 ms (easy-DA)



Ensure clean input signals when the debounce is deactivated as easy reacts even to very short signals.

Delay time with easy-easy-AB, easy-AC basic units

The input delay with AC voltage signals depends on the frequency. The appropriate values for 60 Hz are given in brackets.

- On delay
 - 80 ms at 50 Hz,
 - 66 ms at 60 Hz,
- Off delay for
 - I1 to I6 and I9 to I12: 80 ms (66 ms)
 - I7 and I8: 160 ms (150 ms) with easy-AB
 - I7 and I8: 80 ms (66 ms) with easy-AC

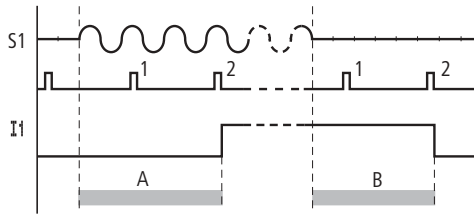

Figure 85: On delay for easy-AC, easy-AB

If the debounce is switched on, easy checks at 40 ms (33 ms) intervals whether there is a half-wave present at an input terminal (1st and 2nd pulses in A). If easy detects two pulses in succession, the device switches on the corresponding input internally.

The input is switched off again as soon as easy does not detect two successive half-waves (1st and 2nd pulses in B).

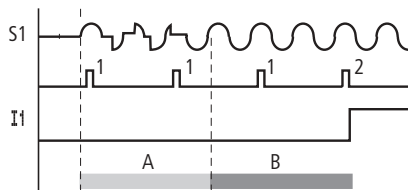

Figure 86: Pushbutton with bounce

If a button or switch bounces (A), the delay time may be extended by 40 ms (33 ms) (A).

If the debounce delay is switched off, the delay time is reduced.

- On delay
20 ms (16.6 ms)
- Off delay for
I1 to I6 and I9 to I12: 20 ms (16.6 ms)
- Off delay for
I7 and I8: 100 ms (100 ms) with easy-AB, easy-AC

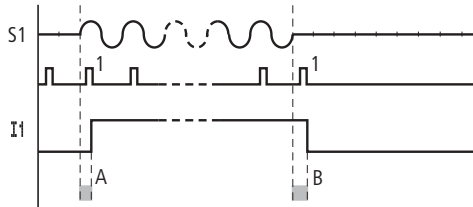

Figure 87: On and off delays

easy switches the contact as soon as it detects a pulse (A). If no pulse is detected, easy switches off the contact (B).



The procedure for changing the delay times is described in section "Activating debounce (input delay)" on page 222.

Delay times for the analog inputs of easy-AB, easy-DA and easy-DC

The analog input values are read at 1 ms intervals. The values are continuously smoothed so that the analog values do not fluctuate excessively and remain clean. At the start of the circuit diagram cycle, the currently available analog values that have been smoothed are provided for processing in the circuit diagram.

Monitoring of short-circuit/overload with EASY...D.-T..

Depending on the type of easy in use, it is possible to use the internal inputs I15 and I16, R15, R16 to monitor for short-circuits or overloads on an output.

- EASY512-...-T...:
 - I16 = Group fault alarm for outputs Q1 to Q4.
- EASY721-...-T...:
 - I16 = Group fault alarm for outputs Q1 to Q4.
 - I15 = Group fault alarm for outputs Q5 to Q8.
- EASY620-D.-TE:
 - R16 = Group fault alarm for outputs S1 to S4.
 - R16 = Group fault alarm for outputs S5 to S8.

Table 34: Status of error outputs

State of outputs	Status I15 or I16, R15 or R16
No fault found	0 = switched off (make contact)
At least one output has a fault	1 = switched on (make contact)

The following examples are for I16 = Q1 to Q4. I15 indicates in the same way short-circuits and overloads on Q5 to Q8.

Example 1: Output with fault indication

The circuit diagram functions as follows:

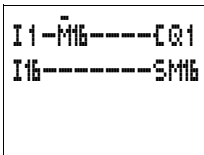

If a transistor output reports a fault, M16 is set by I16. The break contact of M16 switches off output Q1. M16 can be cleared by resetting the easy power supply.

Example 2: Output of operating state

The circuit functions as described in Example 1. An additional feature is that when an overload is detected, the indicator light at Q4 is actuated. If Q4 has an overload, it would 'pulse'.

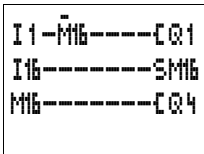

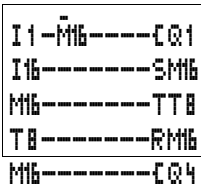

Example 3: Automatic reset of error signal

The circuit diagram functions in the same way as Example 2. In addition the marker M16 is reset every 60 seconds by timing relay T8 (on-delayed, 60 s). Should I16 remain at 1, M16 will continue to be set. Q1 is set briefly to 1 until I16 switches off again.

Expanding easy700

You can expand easy700 with EASY618-.-RE, EASY202-RE or EASY620-D.-TE modules locally or use the EASY200-EASY coupling module for remote expansion.

For this first install the units and connect the inputs and outputs (→ chapter "Installation", page 31).

You process the inputs of the expansion devices as contacts in the easy circuit diagram in the same way as you process the inputs of the basic unit. The input contacts are assigned the operand identifiers R1 to R12.

R15 and R16 are the group fault alarms of the transistor expansion unit (→ section "Monitoring of short-circuit/overload with EASY-.-D.-T..", page 242).

The outputs are processed as relay coils or contacts like the outputs in the basic unit. The output relays are S1 to S8.



EASY618-.-RE provides the outputs S1 to S6. The other outputs S7, S8 can be used as markers.

The following bus modules can also be connected:

- EASY205-ASI (AS-Interface),
- EASY204-DP (Profibus DP),
- EASY221-CO (CANopen) or
- EASY222-DN (Device NET).

These modules offer considerably more functions than simple I/O expansion modules. Depending on type, all the data of the program can be read and setpoints can be written. The functions of the individual devices are described in the relevant documentation.

How is an expansion unit recognised?

easy checks cyclically whether a device is sending data on EASY-LINK.

Transfer behaviour

The input and output data of the expansion units is transferred serially in both directions. Take into account the modified reaction times of the inputs and outputs of the expansion units:

Input and output reaction times of expansion units

The debounce setting has no effect on the expansion unit.

Transfer times for input and output signals:

- **Local expansion**

Time for inputs R1 to R12:

30 ms + 1 cycle

- Time for outputs S1 to S6 (S8):

15 ms + 1 cycle

- **Remote expansion**

Time for inputs R1 to R12:

80 ms + 1 cycle

- Time for outputs S1 to S6 (S8):

40 ms + 1 cycle

Function monitoring of expansion units

If the power supply of the expansion unit is not present, no connection can be established between it and basic unit. The expansion inputs R1 to R12, R15, R16 are incorrectly processed in the basic unit and show status 0. It cannot be assured that the outputs S1 to S8 are transferred to the expansion unit.



Warning!

Ensure the continuous monitoring of easy expansion devices in order to prevent switching faults in machines or systems.

The status of the internal input I14 of the basic unit signals the status of the expansion device:

- I14 = "0": expansion unit is functional
- I14 = "1": expansion unit is not functional



When the power supply is switched on, basic units and expansion devices may require different power up times to reach full functionality. If the basic unit is powered up faster, the internal monitoring input I14 will have status 1, indicating that an expansion device is not functional.

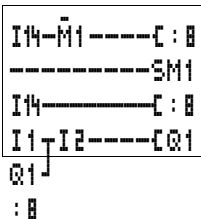

Example

The expansion unit may be powered up later than the basic unit. This means that the basic unit is switched to RUN when an expansion unit is missing. The following easy circuit diagram detects if the expansion unit is functional or not functional.

As long as I14 is 1, the remaining circuit diagram is skipped. If I14 is 0, the circuit diagram is processed. If the expansion unit drops out for any reason, the circuit diagram is skipped. M1 detects whether the circuit diagram was processed for at least one cycle after the power supply is switched on. If the circuit diagram is skipped, all the outputs retain their previous state. The next example should be used if this is not desired.

Example with LCD output and reset of the outputs

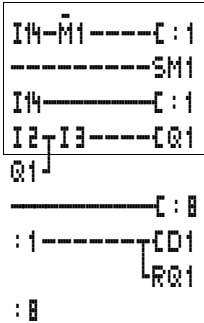

Saving and loading circuit diagrams

You can either use the easy interface to save circuit diagrams to a memory card or use EASY-SOFT-BASIC and a transmission cable to transfer them to a PC.

EASY...-...X

easy models without a keypad can be loaded with a circuit diagram via EASY-SOFT-BASIC or automatically from the fitted memory card every time the power supply is switched on.

Interface

The easy interface is covered.

**DANGER of electric shock with easy-AC units!**

If the voltage terminals for phase (L) and neutral conductor (N) are reversed, the connected 230 V/115 V voltage will be present at the easy interface. There is a danger of electric shock if the plug is not properly connected or if conductive objects are inserted into the socket.

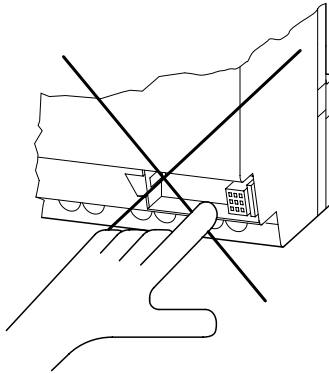

Figure 88: Do not touch the interface

► Carefully remove the cover with a screwdriver.

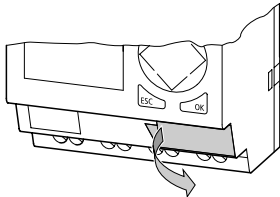

Figure 89: Remove the cover

To close the slot again, push the cover back onto the slot.

Memory card

The card is available as an accessory EASY-M-32K for easy500 and easy700.

Compatibility with EASY-M-8K, EASY-M-16K memory cards

Circuit diagrams with all the data can transferred to the easy500 and easy700 from the EASY-M-8K (easy412) and EASY-M16K (easy600) memory card. A transfer, however, in the other direction is not possible.

Each memory card can hold **one** easy circuit diagram.

Information stored on the memory card is "non-volatile" and thus you can use the card to archive, transfer and copy circuit diagrams.

On the memory card you can save

- the circuit diagram
 - all parameter sets of the function relays
 - all display texts with functions
 - the system settings,
 - debounce
 - P buttons
 - password
 - retention on/off,
 - card start
 - summer time start/end time settings
- ▶ Insert the memory card in the open interface slot.

easy500 (EASY-M-32K):

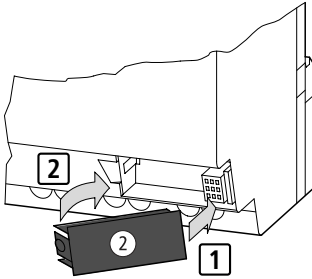

easy700 (EASY-M-32K):

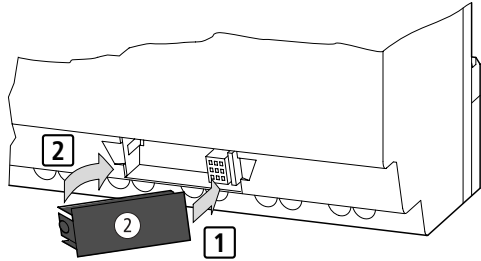

Figure 90: Inserting the memory card



With easy you can insert and remove the memory card even if the power feed is switched on, without the risk of losing data.

Loading or saving circuit diagrams

You can only transfer circuit diagrams in STOP mode.

Behaviour of easy device without integrated keypad, display when loading the memory card

If a memory card is inserted in easy variants without an on-board keypad and LCD, the circuit diagram is automatically transferred from the memory card to the EASY...-...X when the power supply is switched on. If the memory card contains an invalid circuit diagram, the circuit diagram installed in the easy is retained.



The memory card is detected when the card is inserted and you move from the main menu to the program menu.

As read access to EASY-M-8K, EASY-M-16K and EASY-M-32K cards is possible, the card can only be removed in the Status display. This ensures that the correct card is always detected.

Only the EASY-M-32K memory card can be written to.



- ▶ Switch to STOP mode.
- ▶ Select PROGRAM... from the main menu.
- ▶ Select the CARD... menu option.

The CARD... menu option will only appear if you have inserted a functional memory card.



You can transfer a circuit diagram from easy to the card and from the card to the easy memory or delete the content of the card.



If the operating voltage fails during communication with the card, repeat the last step since easy may not have transferred or deleted all the data.

After transmission, remove the memory card and close the cover.

Saving a circuit diagram to the card

- ▶ Select DEVICE-CARD.
- ▶ Confirm the prompt with **OK** to delete the contents of the memory card and replace it with the easy circuit diagram.



Press **ESC** to cancel.

```

DEVICE-CARD
CARD-DEVICE
DELETE CARD

```



Loading a circuit diagram from the card

- ▶ Select the CARD → DEVICE menu option.
- ▶ Press **OK** to confirm the prompt if you want to delete the easy memory and replace it with the card content.

Press **ESC** to go back one menu.

Attention!

Once you have started the CARD → DEVICE transfer, the following operation is initiated:

- The RAM of the device is loaded from the card.
- The internal program memory is cleared.
- The data is written from the card to the internal retentive program memory.

This is carried out in blocks. A complete program is not transferred to the RAM for space reasons.

If an invalid program or an interruption occurs during the read or write operation, easy500 or easy700 loses the program in the internal memory.

Deleting a circuit diagram on the card

- ▶ Select the DELETE CARD menu option.
- ▶ Press **OK** to confirm the prompt and to delete the card content.

Press **ESC** to cancel.

```

DELETE ?

```

EASY-SOFT-BASIC

EASY-SOFT-BASIC is a PC program with which you can create, store, test (simulate) and manage easy circuit diagrams.



You should only transfer data between the PC and easy using the special PC interface cable, which is available as an optional accessory EASY-PC-CAB.



DANGER of electric shock with easy-AC units!
Only the EASY-PC CAB cable will guarantee reliable electrical isolation from the interface voltage.

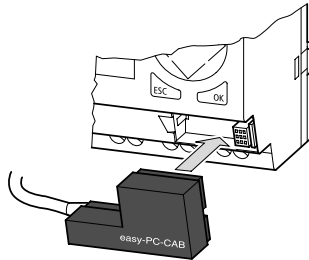

Figure 91: Plug in the EASY-PC-CAB

- ▶ Connect the PC cable to the serial PC interface.
- ▶ Insert the easy plug in the opened interface.
- ▶ Activate the Status display on the easy



easy cannot exchange data with the PC while the circuit diagram display is on screen.

Use EASY-SOFT-BASIC to transfer circuit diagrams from your PC to easy and vice versa. Switch easy to RUN mode from the PC to test the program using the current wiring.

EASY-SOFT-BASIC provides extensive help on how to use the software.

- ▶ Start EASY-SOFT-BASIC and click on Help.

The help provides all the additional information about EASY-SOFT-BASIC that you will need.

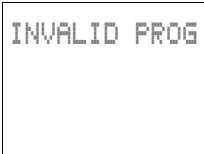

If there are transmission problems, easy will display the INVALID PROG message.

- ▶ Check whether the circuit diagram is suitable for the destination device.



If the operating voltage fails during communication with the PC, repeat the last step. It is possible that not all the data was transferred between the PC and easy.

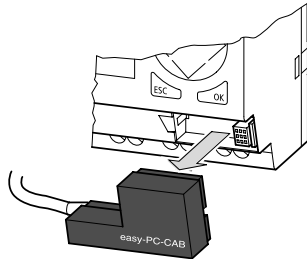

Figure 92: Removing the EASY-PC-CAB

- ▶ After transmission, remove the cable and close the cover.

Overview with stand-alone display/operating unit

easy500 and easy700 can be operated with a stand-alone display/operating unit. In this configuration, all the display information is transferred via the easy interface.

This has the advantage that easy can be operated remotely. The texts in easy are backlit and displayed on the front of the operator or control panel in twice the size. The display/operating unit provides protection to IP65.

If a display/operating unit with a keypad is used, easy can be programmed and assigned parameters from "outside".



Card mode operation is not possible when using a stand-alone display/operating unit. The interface can only be used once.

The MFD-80 (IP65 display unit), MFD-80-B (IP65 display/operating unit) with the MFD-CP4-500 power supply/communication unit are currently available for use as stand-alone display/operating units.



The MFD-CP4 communication unit establishes permanent communication with the easy control relay. This increases easy's cycle time, and must be taken into account during engineering.

Device version

Every easy has the device version number printed on the left of the device housing. The device version is indicated by the first two digits of the device number.

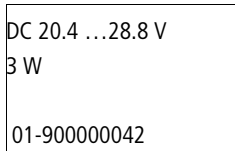

Figure 93: Example of device version

This device is of device version 01.

The device version provides useful service information about the hardware version and the version of the operating system. The device version is important for selecting the correct control relay for EASY-SOFT-BASIC.

7 What Happens If ...?

You may sometimes find that easy does not do exactly what you expect. If this happens, read through the following notes which are intended to help you solve some of the problems you may encounter.

You can use the power flow display in easy to check the logic operations in the easy circuit diagram with reference to the switching states of contacts and relays.

Only qualified persons should test easy voltages while the device is in operation.

Messages from the easy system

easy system messages on the LCD	Explanation	Remedy
No display	Power supply interrupted	Switch on the power supply
	easy LCD faulty	Replace easy
Continuous display		
TEST: AC	Self-test aborted	Replace easy
TEST: EEPROM		
TEST: DISPLAY		
TEST: CLOCK		
ERROR: I2C	Memory card removed or not inserted correctly before saving	Insert memory card
	Memory card faulty	Replace memory card
	easy is faulty	Replace easy
ERROR: EEPROM	The memory for storing the retentive values or the easy circuit diagram memory is faulty.	Replace easy

easy system messages on the LCD	Explanation	Remedy
ERROR: CLOCK	Clock error	Replace easy
ERROR: LCD	LCD is faulty	Replace easy
ERROR: ACLOW	Incorrect AC voltage	Test the voltage
	easy is faulty	Replace easy

Possible situations when creating circuit diagrams

Possible situations when creating circuit diagrams	Explanation	Remedy
Cannot enter contact or relay in circuit diagram	easy is in RUN mode	Select STOP mode
Time switch switches at wrong times	Incorrect time or time switch parameters	Check time and parameters
Message when using a memory card PROG INVALID	easy memory card contains no circuit diagram	Change the version of easy or change the circuit diagram on the memory card
	Circuit diagram on the memory card uses contacts/relays that easy does not recognise	
Power flow display does not show changes to the rungs	easy is in STOP mode	Select RUN mode
	Association/connection not fulfilled	Check the circuit diagram and parameter sets and modify as required
	Relay does not activate coil	
	Incorrect parameter values/time	
<ul style="list-style-type: none"> • Analog value comparison is incorrect • Time value of timing relay is incorrect • Function of timing relay is incorrect 		
Relay Q or M does not pick up	Relay coil has been wired up several times	Check coil field entries

Possible situations when creating circuit diagrams	Explanation	Remedy
Input not detected	Loose terminal contact	Check installation instructions, check external wiring
	No voltage to switch/button	
	Broken wire	
Relay output Q does not switch and activate the load	easy input is faulty	Replace easy
	easy in STOP mode	Select RUN mode
	No voltage at relay contact	Check installation instructions, check external wiring
	easy power supply interrupted	
	easy circuit diagram does not activate relay output	
	Broken wire	
	easy relay is faulty	Replace easy

Event		
Event	Explanation	Remedy
The actual values are not being stored retentively.	Retention has not been switched on.	Switch on retention in the SYSTEM menu.
The RETENTION... menu is not displayed in the SYSTEM menu.	easy is in RUN mode	Select STOP mode
The SYSTEM menu is not displayed.	This easy model does not have this menu.	Exchange easy if you need retention
easy starts only in operating mode STOP	No circuit diagram in easy	Load, input circuit diagram
	Startup behaviour is set to the function "Startup in operating mode STOP".	Set the startup behaviour in the SYSTEM menu.
LCD display showing nothing	No power supply	Switch on the power supply
	easy is faulty	Press the OK button. If no menu appears, replace the easy.
	Text displayed with too many spaces	Enter text or do not select spaces
GW flashes on the Status display	EASY200-EASY bus coupler detected without I/O expansion	Connect I/O expansion to external EASY-LINK

Appendix

Dimensions

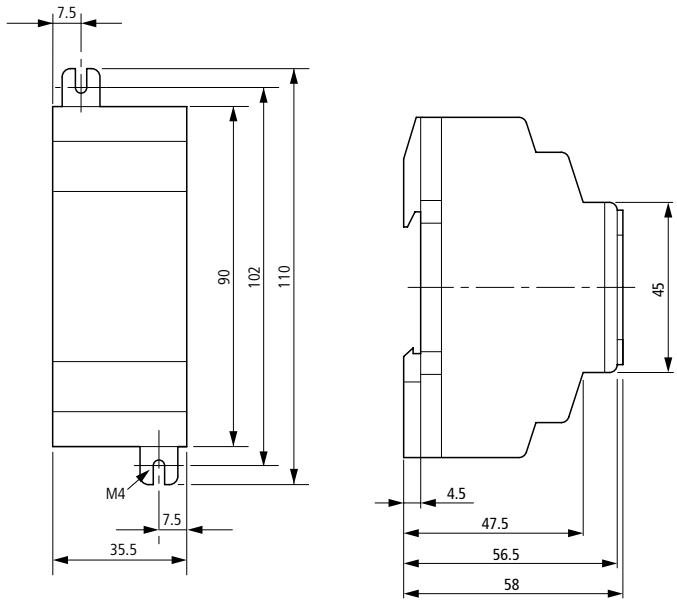

Figure 94: Dimensions of easy200 in mm (for dimensions in inches see page 261, table 35)

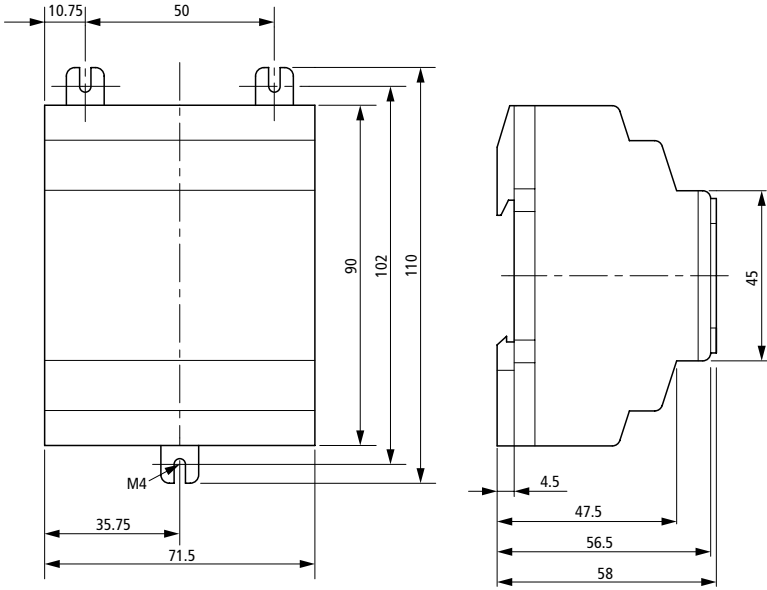

Figure 95: Dimensions of easy512-... in mm (for dimensions in inches see page 261, table 35)

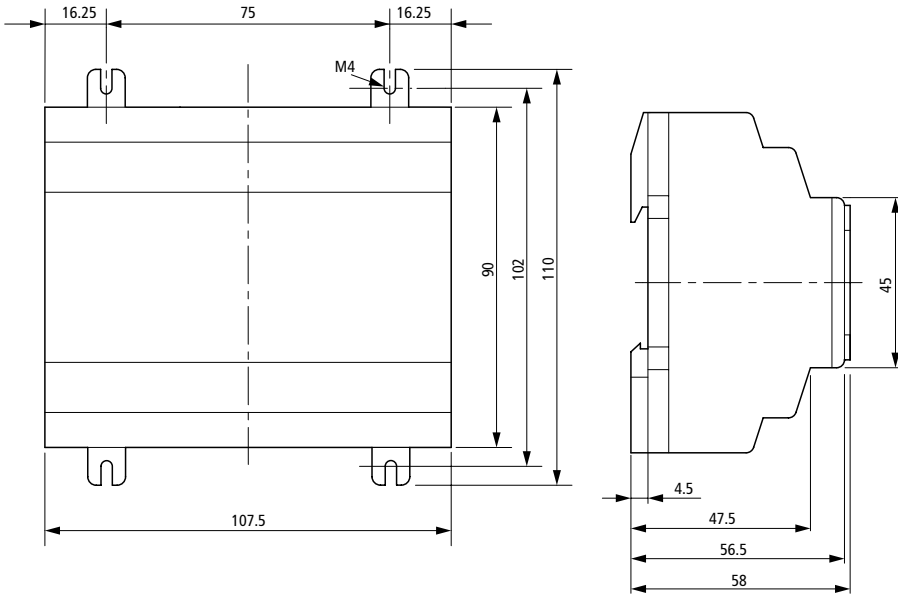

Figure 96: Dimensions of easy600, easy700 in mm (for dimensions in inches see table 35)

Table 35: Dimensions in inches

mm	inches	mm	inches
4.5	0.177	56.5	2.22
7.5	0.295	58	2.28
10.75	4.23	71.5	2.81
16.25	0.64	75	2.95
35.5	1.4	90	3.54
35.75	1.41	102	4.01
45	1.77	107.5	4.23
47.5	1.87	110	4.33
50	1.97		

Technical Data	General		
	EASY...		
	easy200	easy512	easy600, easy700
Dimensions W × H × D			
[mm]	35.5 × 90 × 56.5	71.5 × 90 × 56.5	107.5 × 90 × 56.5
[inches]	1.4 × 3.54 × 2.08	2.81 × 3.54 × 2.08	4.23 × 3.54 × 2.08
Space units (SU) width	2 space units wide	4 SU (space units) wide	6 SU (space units) wide
Weight			
[g]	70	200	300
[lb]	0.154	0.441	0.661
Mounting	DIN 50022, 35 mm rail or screw mounting with 3 ZB101-GF1 fixing brackets (accessories); with easy200 only 2 fixing brackets required.		

**Climatic environmental conditions
(Cold to IEC 60068-2-1, Heat to IEC 60068-2-2)**

Ambient temperature Installed horizontally/vertically	-25 to 55 °C, -13 to 131 °F
Condensation	Prevent condensation with suitable measures
LCD display (reliably legible)	0 to 55 °C, 32 to 131 °F
Storage/transport temperature	-40 to +70 °C, -40 to 158 °F
Relative humidity (IEC 60 068-2-30)	5 to 95 %, non-condensing
Air pressure (operation)	795 to 1080 hPa
Corrosion resistance	
IEC 60 068-2-42	SO ₂ 10 cm ³ /m ³ , 4 days
IEC 60 068-2-43	H ₂ S 1 cm ³ /m ³ , 4 days
Inflammability class to UL 94	V0

Ambient mechanical conditions

Pollution degree	2
Degree of protection (EN 50178, IEC 60529, VBG4)	IP 20

Oscillations (IEC 60068-2-6)	10 to 57 Hz (constant amplitude 0.15 mm)
	57 to 150 Hz (constant acceleration 2 g)
Shock (IEC 60068-2-27)	18 shocks (semi-sinusoidal 15 g/11 ms)
Drop (IEC 60068-2-31)	Drop height 50 mm
Free fall, packed (IEC 60068-2-32)	1 m
Electromagnetic compatibility (EMC)	
Electrostatic discharge (ESD), (IEC/EN 61 000-4-2, severity level 3)	8 kV air discharge, 6 kV contact discharge
Electromagnetic fields (RFI), (IEC/EN 61000-4-3)	Field strength 10 V/m
Emitted interference Interference immunity (EN 55011, EN 55022) IEC 61000-6-1,2,3,4	Class B
Fast transient burst (IEC/EN 61000-4-4, severity level 3)	2 kV power cables, 2 kV signal cables
High-energy pulses (surge) easy-AC (IEC/EN 61000-4-5)	2 kV power cable symmetrical
Surge easy-DA, easy-DC, easy-AB (IEC/EN 61000-4-5, severity level 2)	0.5 kV power cable symmetrical
Line-conducted interference (IEC/EN 61 000-4-6)	10 V
Dielectric strength	
Clearance and creepage distances	EN 50178, UL 508, CSA C22.2, No 142
Dielectric strength	EN 50178
Overvoltage category/pollution degree	II/2
Tools and cable cross-sections	
Solid	min. 0.2 mm ² , max. 4 mm ² /AWG: 22 – 12
Flexible with ferrule	min. 0.2 mm ² , max. 2.5 mm ² /AWG:22 – 12 Factory wiring: to AWG 30
Slot-head screwdriver, width	3.5 × 0.8 mm
Tightening torque	0.6 Nm

Backup/accuracy of real-time clock (only with easy-C)

Clock battery back-up

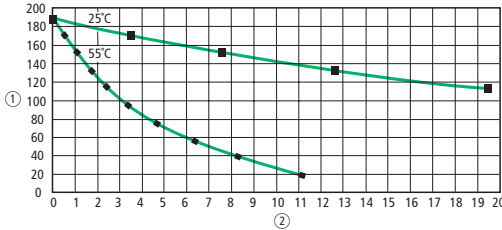

① = backup time in hours

② = service life in years

Accuracy of the real-time clock

Normally ± 5 s/day, $\sim \pm 0.5$ h/year

Repetition accuracy of timing relays

Accuracy of timing relays

$\pm 1\%$ of value

Resolution

Range "s"

10 ms

Range "M:S"

1 s

Range "H:M"

1 min.

Retentive memory

Write cycles of the retentive memory (minimum)

1000000

Rungs (basic units)

EASY512, easy700

128

Special approvals

CSA

Hazardous Locations CLASS I Division 2 Groups A, B, C and D Temperature Code T3C -160 °C in 55 °C ambient.

(testing in progress)

Power supply**EASY512-AC-..., EASY719-AC-..., EASY512-AB-...,
EASY719-AB-...**

	EASY512-AB-..., EASY719-AB-...	EASY512-AC-..., EASY719-AC-...
Rated value (sinusoidal)	24 V AC	100/110/115/120/230/240 V AC
Operating range	+10/–15 % 20.4 to 26.4 V AC	+10/–15 % 85 to 264 V AC
Frequency, rated value, tolerance	50/60 Hz, $\pm 5\%$	50/60 Hz, $\pm 5\%$
Input current consumption	EASY512-AB-... EASY719-AB- ...	EASY512-AB-... EASY719-AB- ...
at 115/120 V AC 60 Hz		Normally 40 mA/70 mA
at 230/240 V AC 50 Hz		Normally 20 mA/35 mA
at 24 V AC 50/60 Hz	Normally 200 mA/normally 300 mA	
Voltage dips	20 ms, IEC/EN 61131-2	20 ms, IEC/EN 61131-2
Power loss	EASY512-AB-... EASY719-AB- ...	EASY512-AC-... EASY719-AC- ...
at 115/120 V AC		Normally 5 VA/normally 10 VA
at 230/240 V AC		Normally 5 VA/normally 10 VA
at 24 V AC	Normally 5 VA/normally 7 VA	

**EASY512-DA-..., EASY719-DA-..., EASY512-DC-...,
EASY719-DC-..., EASY721-DC-...**

	EASY512-DA-..., EASY719-DA-...	EASY512-DC-..., EASY719-DC-..., EASY721-DC-...
Rated voltage		
Rated value	12 V DC, +30 %, –15 %	24 V DC, +20 %, –15 %
Permissible range	10.2 to 15.6 V DC	20.4 to 28.8
Residual ripple	$\leq 5\%$	$\leq 5\%$

	EASY512-DA-..., EASY719-DA-...	EASY512-DC-..., EASY719-DC-..., EASY721-DC-...
Input current at rated voltage	EASY512-DA-... EASY719-DA-... Normally 140 mA/normally 200 mA	EASY512-DC-... EASY7...-DC-... Normally 80 mA/normally 140 mA
Voltage dips	10 ms, IEC/EN 61131-2	
Power loss	EASY512-DA-... EASY719-DA-... Normally 2 mA/3.5 mA	EASY512-DC-... EASY7...-DC-... Normally 2 W/normally 3.5 W

Inputs

EASY-512-AB-..., EASY719-AB-...

	EASY-512-AB-...	EASY719-AB-...
Digital inputs 24 V AC		
Number	8	12
Status display	LCD (if provided) 2 inputs (I7, I8) usable as analog inputs	LCD (if provided) 4 inputs (I7, I8, I11, I12) usable as analog inputs
Electrical isolation		
To power supply	No	No
Between each other	No	No
To the outputs	Yes	Yes
Rated voltage L (sinusoidal)	24 V AC	24 V AC
0 signal	0 to 6 V AC	0 to 6 V AC
1 signal	(I7, I8) ≥ 8V AC, ≥ 11 V DC (I1 to I6, I9 to I12) 14 to 26.4 V AC	(I7, I8, I11, I12) ≥ 8 V AC, ≥ 11 V DC (I1 to I6, I9 to I10) 14 to 26.4 V AC
Rated frequency	50/60 Hz	50/60 Hz

	EASY-512-AB-...	EASY719-AB-...
Input current on 1 signal I1 to I6 (EASY719.. also I9 to I10)	4 mA at 24 V AC 50 Hz	4 mA at 24 V AC, 50 Hz
Input current on 1 signal I7, I8, (EASY719.. also I11, I12)	2 mA at 24 V AC, 50 Hz 2 mA at 24 V DC	2 mA at 24 V AC, 50 Hz 2 mA at 24 V DC
Delay time for 0 to 1 and 1 to 0 for I1 to I8, EASY719... also I9 to I12		
Debounce ON	80 ms (50 Hz), 66 ² / ₃ ms (60 Hz)	80 ms (50 Hz), 66 ² / ₃ ms (60 Hz)
Debounce OFF	20 ms (50 Hz), 16 ² / ₃ ms (60 Hz)	20 ms (50 Hz), 16 ² / ₃ ms (60 Hz)
Max. permissible cable length (per input)		
I1 to I8, (with EASY719... also I9 to I10)	Normally 40 m	Normally 40 m

EASY-512-AC-..., EASY618-AC-E, EASY719-AC-...

	EASY-512-AC-...	EASY618-AC-E, EASY719-AC-...
--	------------------------	-------------------------------------

Digital inputs 115/230 V AC

Number	8	12
Status display	LCD (if provided)	LCD (if provided)
Electrical isolation		
To power supply	No	No
Between each other	No	No
To the outputs	Yes	Yes
Rated voltage L (sinusoidal)		
0 signal	0 to 40 V AC	0 to 40 V AC
1 signal	79 to 264 V AC	79 to 264 V AC
Rated frequency	50/60 Hz	50/60 Hz

	EASY-512-AC-...	EASY618-AC-E, EASY719-AC-...
Input current with 1 signal R1 to R12, I1 to I6 (EASY71.. also I9 to I12)	6 × 0.5 mA at 230 V AC 50 Hz, 6 × 0.25 mA at 115 V AC 60 Hz	10 × (12) 0.5 mA at 230 V AC, 50 Hz 10 × (12) × 0.25 mA at 115 V AC, 60 Hz
Input current on 1 signal I7, I8	2 × 6 mA at 230 V AC 50 Hz, 2 × 4 mA at 115 V AC 60 Hz	2 × 6 mA at 230 V AC 50 Hz, 2 × 4 mA at 115 V AC 60 Hz
Delay time for 0 to 1 and 1 to 0 for I1 to I6, I9 to I12		
Debounce ON	80 ms (50 Hz), 66 ² / ₃ ms (60 Hz)	80 ms (50 Hz), 66 ² / ₃ ms (60 Hz)
Debounce OFF (also R1 to R12)	20 ms (50 Hz), 16 ² / ₃ ms (60 Hz)	20 ms (50 Hz), 16 ² / ₃ ms (60 Hz)
Delay time I7, I8 for 1 to 0		
Debounce ON	160 ms (50 Hz), 150 ms (60 Hz)	80 ms (50 Hz), 66 ² / ₃ ms (60 Hz)
Debounce OFF	100 ms (50 Hz/60 Hz)	20 ms (50 Hz), 16 ² / ₃ ms (60 Hz)
Delay time I7, I8 for 0 to 1		
Debounce ON	80 ms (50 Hz), 66 ² / ₃ ms (60 Hz)	80 ms (50 Hz), 66 ² / ₃ ms (60 Hz)
Debounce OFF	20 ms (50 Hz), 16 ² / ₃ ms (60 Hz)	20 ms (50 Hz), 16 ² / ₃ ms (60 Hz)
Max. permissible cable length (per input)		
I1 to I6, R1 to R12 (with EASY719-.. also I9 to I12)	Normally 40 m	Normally 40 m
I7, I8	Normally 100 m	Normally 100 m

EASY512-DA-..., EASY719-DA-...

	EASY512-DA-...	EASY719-DA-...
Digital inputs		
Number	8	12
	2 inputs (I7, I8) usable as analog inputs	4 inputs (I7, I8, I11, I12) usable as analog inputs

	EASY512-DA-...	EASY719-DA-...
Status display	LCD (if provided)	LCD (if provided)
Electrical isolation		
To power supply	No	No
Between each other	No	No
To the outputs	Yes	Yes
Rated voltage		
Rated value	12 V DC	12 V DC
0 signal	4 V DC (I1 to I8)	4 V DC (I1 to I12)
1 signal	8 V DC (I1 to I8)	8 V DC (I1 to I12)
Input current on 1 signal	3.3 mA at 12 V DC (I1 to I6)	3.3 mA at 12 V DC (I1 to I6, I9 to I12)
I7, I8	1.1 mA at 12 V DC	1.1 mA at 12 V DC

Delay time for 0 to 1

Debounce ON	20 ms	20 ms
Debounce OFF	Normally 0.3 ms (I1 to I16) Normally 0.35 ms (I7, I8)	Normally 0.3 ms (I1 to I6, I9, I10) Normally 0.35 ms (I7, I8, I11, I12)

Delay time for 1 to 0

Debounce ON	20 ms	20 ms
Debounce OFF	Normally 0.3 ms (I1 to I16) Normally 0.15 ms (I7, I8)	Normally 0.4 ms (I1 to I6, I9 to I10) Normally 0.2 ms (I7, I8, I11, I12)
Cable length (unshielded)	100 m	100 m

EASY512-DC-..., EASY6...-DC-E, EASY7...-DC-

	EASY512-DC-...	EASY6...-DC-E	EASY7...-DC-...
--	----------------	---------------	-----------------

Digital inputs

Number	8 2 inputs (I7, I8) usable as analog inputs	12	12 4 inputs (I7, I8, I11, I12) usable as analog inputs
Status display	LCD (if provided)		

	EASY512-DC-...	EASY6...-DC-E	EASY7...-DC-...
Electrical isolation			
To power supply	No	No	No
Between each other	No	No	No
To the outputs	Yes	Yes	Yes
Rated voltage			
Rated value	24 V DC	24 V DC	24 V DC
0 signal	< 5 V DC (I1 to I8)	< 5 V DC (R1 to R12)	< 5 V DC (I1 to I12)
1 signal	> 8 V DC (I7, I8)		> 8 V DC (I7, I8, I11, I12)
	> 15 V DC (I1 to I6)	> 15 V DC (R1 to R12)	> 15 V DC (I1 to I6, I9, I10)
Input current on 1 signal	3.3 mA at 24 V DC (I1 to I6)	3.3 mA at 24 V DC (R1 to R12)	3.3 mA at 24 V DC (I1 to I6, I9, I10)
I7, I8 (easy7...-DC-.. also I11, I12)	2.2 mA at 24 V DC		2.2 mA at 24 V DC
Delay time for 0 to 1			
Debounce ON	20 ms	20 ms	20 ms
Debounce OFF easy512.DC-.. I1 to I8 easy6...-DC-.. R1 to R12 easy7..._DC-.. I1 to I12	Normally 0.25 ms		
Delay time for 1 to 0			
Debounce ON	20 ms	20 ms	20 ms
Debounce OFF	<ul style="list-style-type: none"> • Normally 0.4 ms (I1 to I16) • Normally 0.2 ms (I7, I8) 	Normally 0.4 ms (R1 to R12)	<ul style="list-style-type: none"> • Normally 0.4 ms (I1 to I6, I9, I10) • Normally 0.2 ms (I7, I8, I11, I12)
Cable length (unshielded)	100 m	100 m	100 m

High-speed counter inputs, I1 to I4		EASY512-DA-..., EASY512-DC-..., EASY719-DA-..., EASY719-DC-..., EASY721-DC-...
Number		4
Cable length (shielded)	m	20
High-speed up and down counters		
Counting frequency	kHz	< 1
Pulse shape		Square wave
Mark-to-space ratio		1:1
Frequency counters		
Counting frequency	kHz	< 1
Pulse shape		Square wave
Mark-to-space ratio		1:1
	EASY512-AB-..., EASY512-DA-..., EASY512-DC-...	EASY719-AB-..., EASY719-DA-..., EASY719-DC-..., EASY721-DC-...
Analog input I7, I8, I11, I12		
Number	2	4
Electrical isolation		
To power supply	No	No
To the digital inputs	No	No
To the outputs	Yes	Yes
Input type	DC voltage	DC voltage
Signal range	0 to 10 V DC	0 to 10 V DC
Resolution analog	10 mV	10 mV
Resolution digital	0.01 (10-bit, 1 to 1023)	0.01 (10-bit, 0 to 1023)
Input impedance	11.2 kΩ	11.2 kΩ

	EASY512-AB-..., EASY512-DA-..., EASY512-DC-...	EASY719-AB-..., EASY719-DA-..., EASY719-DC-..., EASY721-DC-...
Accuracy of		
Two easy devices	±% of actual value	± 3 % of actual value
Within a single device	± 2 % of actual value (I7, I8), ± 0.12 V	
Conversion time, analog/digital	Debounce ON: 20 ms Debounce OFF: every cycle	
Input current at 10 V DC	1 mA	1 mA
Cable length (shielded)	30 m	30 m

Relay outputs

EASY512-...-R..., EASY618-...-RE/EASY719-...-R..., EASY202-RE

	EASY512-...-R...	EASY618-...-RE/ EASY719-...-R..	EASY202-RE
Number	4	6	2
Type of outputs	Relay		
In groups of	1	1	2
Connection of outputs in parallel to increase the output	Not permissible		
Protection for an output relay	Miniature circuit-breaker B16 or 8 A fuse (slow)		
Potential isolation to mains supply, inputs	Yes 300 V AC (safe isolation) 600 V AC (basic isolation)		
Mechanical lifespan (switching operations)	10 × 10 ⁶		
Contacts relays			
Conventional therm. current	8 A (10 A UL)		
Recommended for load	> 500 mA, 12 V AC/DC		
Short-circuit resistance cos φ = 1	16 A characteristic B (B16) at 600 A		

	EASY512-...-R...	EASY618-...-RE/ EASY719-...-R..	EASY202-RE
Short-circuit resistance $\cos \varphi = 0.5$ to 0.7	16 A characteristic B (B16) at 900 A		
Rated impulse withstand voltage U_{imp} contact coil	6 kV		
Rated insulation voltage U_i			
Rated operational voltage U_e	250 V AC		
Safe isolation to EN 50178 between coil and contact	300 V AC		
Safe isolation to EN 50178 between two contacts	300 V AC		
Making capacity			
AC-15 250 V AC, 3 A (600 Ops/h)	300 000 operations		
DC-13 L/R ≤ 150 ms 24 V DC, 1 A (500 Ops/h)	200 000 operations		
Breaking capacity			
AC-15 250 V AC, 3 A (600 Ops/h)	300 000 operations		
DC-13 L/R ≤ 150 ms 24 V DC, 1 A (500 Ops/h)	200 000 operations		
Filament lamp load	1000 W at 230/240 V AC/25000 operations 500 W at 115/120 V AC/25000 operations		
Fluorescent tube with ballast	10 \times 58 W at 230/240 V AC/25000 operations		
Conventional fluorescent tube, compensated	1 \times 58 W at 230/240 V AC/25000 operations		
Fluorescent tube, uncompensated	10 \times 58 W at 230/240 V AC/25000 operations		
Operating frequency, relays			
Mechanical switching operations	10 million (1×10^7)		

	EASY512-...-R...	EASY618-...-RE/ EASY719-...-R..	EASY202-RE
Mechanical switching frequency	10 Hz		
Resistive lamp load	2 Hz		
Inductive load	0.5 Hz		

UL/CSA

Uninterrupted current at 240 V AC/24 V DC		10/8 A
AC	Control Circuit Rating Codes (Utilization category)	B300 Light Pilot Duty
	Max. rated operational voltage	300 V AC
	Max. thermal continuous current $\cos \varphi = 1$ with B300	5 A
	Maximum make/break capacity $\cos \varphi \neq 1$ (Make/break) with B300	3600/360 VA
DC	Control Circuit Rating Codes (Utilization category)	R300 Light Pilot Duty
	Max. rated operational voltage	300 V DC
	Max. thermal uninterrupted current with R300	1 A
	Maximum make/break capacity with R300	28/28 VA

Transistor outputs**EASY-512-D-T..., EASY620-DC-.E, EASY72...**

	EASY512-D-T...	EASY620-DC-.E, EASY72...
Number of outputs	4	8
Contacts	Semiconductors	Semiconductors
Rated voltage U_e	24 V DC	24 V DC
Permissible range	20.4 to 28.8 V DC	20.4 to 28.8 V DC
Residual ripple	$\leq 5\%$	$\leq 5\%$
Supply current		
0 signal	Normally 9 mA/max. 16 mA	Normally 18 mA/max. 32 mA
1 signal	Normally 12 mA, max. 22 mA	Normally 24 mA, max. 44 mA

	EASY512-D.-T...	EASY620-DC-.E, EASY72...
Reverse polarity protection	Yes, caution! If voltage is applied to the outputs when the polarity of the power supply is reversed, this will result in a short circuit.	
Potential isolation to mains supply, inputs	Yes	Yes
Rated current I_e on 1 signal	max. 0.5 A DC	max. 0.5 A DC
Lamp load	5 Watts without R_V	5 Watts without R_V
Residual current at state 0 per channel	< 0.1 mA	< 0.1 mA
Max. output voltage		
On 0 signal with ext. load < 10 M Ω	2.5 V	2.5 V
On 1 signal, $I_e = 0.5$ A	$U = U_e - 1$ V	$U = U_e - 1$ V
Short-circuit protection	Yes, thermal (detected via diagnostics input I16, I15; R16;R15)	
Short-circuit tripping current for $R_a \leq 10$ m Ω	0.7 A $\leq I_e \leq 2$ A per output	
Max. total short-circuit current	8 A	16 A
Peak short-circuit current	16 A	32 A
Thermal cutout	Yes	Yes
Max. switching frequency with constant resistive load $R_L < 100$ k Ω : operations/hour	40000 (depends on program and load)	
Parallel connection of outputs with resistive load; inductive load with external suppression circuit (see page 58) combination within a group	Group 1: Q1 to Q4	<ul style="list-style-type: none"> • Group 1: Q1 to Q4, S1 to S4 • Group 2: Q5 to Q8, S5 to S8

	EASY512-D.-T...	EASY620-DC-.E, EASY72...
Number of outputs	max. 4	max. 4
Total maximum current	2.0 A, Attention! Outputs must be actuated simultaneously and for the same time duration.	
Status display of the outputs	LCD display (if provided)	

Inductive load (without external suppressor circuit)

General explanations:

$T_{0.95}$ = time in milliseconds until 95 % of the stationary current is reached.

$$T_{0.95} \approx 3 \times T_{0.65} = 3 \times \frac{L}{R}$$

Utilisation category in groups for:

- Q1 to Q4,
- Q5 to Q8,
- S1 to S4,
- S5 to S8.

$T_{0.95} = 1 \text{ ms}$ $R = 48 \ \Omega$ $L = 16 \text{ mH}$	Utilization factor		$g = 0.25$
	Relative duty factor	%	100
	Maximum switching frequency $f = 0.5 \text{ Hz}$	Operations/h	1500
	Maximum duty factor DF = 50 %		
DC13 $T_{0.95} = 72 \text{ ms}$ $R = 48 \ \Omega$ $L = 1.15 \text{ H}$	Utilization factor		$g = 0.25$
	Relative duty factor	%	100
	Maximum switching frequency $f = 0.5 \text{ Hz}$	Operations/h	1500
	Maximum duty factor D = 50 %		

Other inductive loads:

$T_{0.95} = 15 \text{ ms}$ $R = 48 \Omega$ $L = 0.24 \text{ H}$	Utilization factor		$g = 0.25$
	Relative duty factor	%	100
	Maximum switching frequency $f = 0.5 \text{ Hz}$ Maximum duty factor DF = 50 %	Operations/h	1500
	Inductive load with external suppressor circuit for each load (see section "Connecting transistor outputs" on)		
	Utilization factor		$g = 1$
	Relative duty factor	%	100
	Max. switching frequency Max. duty factor	Operations/h	Depends on the suppressor circuit

List of the function relays Usable contacts

Contact type	Make contact	Break contact	easy500	easy700	Page
Analog value comparator function relay	A	\bar{A}	A1...A16	A1...A16	104
Counter relay contact	C	\bar{C}	C1...C16	C1...C16	117
Text display function relay	D	\bar{D}	D1...D16	D1...D16	137
7-day time switch function relay	Ø	$\bar{Ø}$	Ø1...Ø8	Ø1...Ø8	143
easy input terminal	I	\bar{I}	I1...I8	I1...I12	83
0 signal			I13	I13	
Expansion status			–	I14	245
Short-circuit/overload			I16	I15...I16	242
Marker (auxiliary relay)	M	\bar{M}	M1...M16	M1...M16	91
Marker (auxiliary relay)	N	\bar{N}	N1...N16	N1...N16	
Operating hours counter	O	\bar{O}	O1...O4	O1...O4	149
Cursor button	P	\bar{P}	P1...P4	P1...P4	89

Contact type	Make contact	Break contact	easy500	easy700	Page
easy output	Q	\bar{Q}	Q1...Q4	Q1...Q8	83
Expansion input terminal	R	\bar{R}	—	R1...R12	83
Short-circuit/overload with expansion	R	\bar{R}	—	R15...R16	242
easy output (expansion or S auxiliary marker)	S	\bar{S}	S1...S8 (as marker)	S1...S8	91
Timing function relay	T	\bar{T}	T1...T16	T1...T16	154
Jump label	:	—	:1...:8	:1...:8	171
Year time switch	Y	\bar{Y}	Y1...Y8	Y1...Y8	174
Master reset, (central reset)	Z	\bar{Z}	Z1...Z3	Z1...Z3	181

Available function relays

Relay	easy display	easy500	easy700	Coil function	Parameters
Analog value comparator function relay	A	A1...A16	A1...A16	—	✓
Counter relay contact	C	C1...C16	C1...C16	✓	✓
Text marker function relays	D	D1...D16	D1...D16	✓	✓
7-day time switch function relay	Ø	Ø1...Ø8	Ø1...Ø8	—	✓
Marker (auxiliary relay)	M	M1...M16	M1...M16	✓	—
Marker (auxiliary relay)	N	N1...N16	N1...N16	✓	—
Operating hours counter	O	O1...O4	O1...O4	✓	✓
easy output relay	Q	Q1...Q4	Q1...Q8	✓	—
easy output relay expansion, auxiliary marker	S	S1...S8 (as marker)	S1...S8	✓	—
Timer function relay	T	T1...T16	T1...T16	✓	✓

Relay	easy display	easy500	easy700	Coil function	Parameters
Conditional jump	:	:1...:8	:1...:8	✓	–
Year time switch	Y	Y1...Y4	Y1...Y4	–	✓
Master reset, (central reset)	Z	Z1...Z8	Z1...Z8	✓	–

Names of relays

Relay	Meaning of abbreviation	Function relay designation	Page
A	Analog value comparator	Analog value comparator	104
C	counter	Counter	117
D	display	Text display	137
W	(week, Software)	7-day time switch	143
O	operating time	Operating hours counter	149
T	timing relay	Timing relay	154
Y	year	Year time switch	174
Z	zero reset,	Master reset	181

Names of function relay

Function relay coil	Meaning of abbreviation	Description
C	count input	Counter input, counter
D	direction input	Counter direction, counter
H	hold, stop	Stopping of timing relay, stop, timing relay
R	reset	Reset of actual value to zero, operating hours counters, counters, text displays, timing relays
T	trigger	Timing coil, timing relay

Name of function block inputs (constants, operands)

Input	Meaning of abbreviation	Description
F1	Factor 1	Gain factor for I1 ($I1 = F1 \times \text{Value}$)
F2	Factor 2	Gain factor for I2 ($I2 = F2 \times \text{Value}$)
HY	Hysteresis	Switching hysteresis for value I2 (Value HY applies to positive and negative hysteresis.)
D	Day	Day
I1	Input 1	1st setpoint, comparison value
I2	Input 2	2nd setpoint, comparison value
S	Setpoint	Setpoint, limit value

Compatibility of function relay parameters

The function relays of the easy400 and easy600 devices have been transferred to the easy500 and easy700 with enhanced functions. The parameter displays were adapted for the function enhancements.

Parameter display of analog value comparator



easy400, easy600 parameters

AA
BB
A1
+
≥

easy500, easy700 parameters

= I1 AA
= I2 BB
= A1
= +
= GE

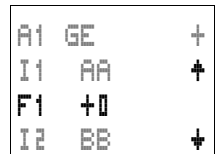

A1 GE +
I1 AA +
F1 +0
I2 BB +
F2 +0
OS +0
HV +0

Parameter display of counters



easy400, easy600 parameters

AAAA
C1
+

easy500, easy700 parameters

= S AAAAA
=
= C1
= +



C1 N +
S AAAAA
S AAAAA

Parameter display of 7-day time switch

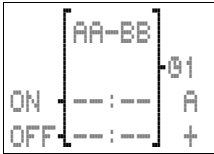

easy400, easy600 parameters

01
AA-BB
A
ON ---:--
OFF ---:--
+

easy500, easy700 parameters

= 01
= AA-BB
= A
= ON ---:--
= OFF ---:--
= +

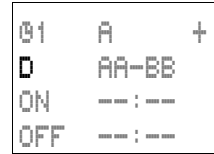

Parameter display of timing relay

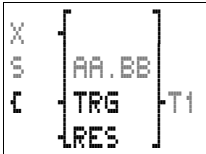

easy400, easy600 parameters

T1
X
S
AA.BB
+

easy500, easy700 parameters

= T1
= X
= S
= AA.BB
= +

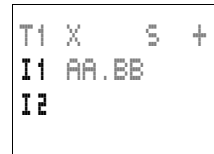

Compatibility of memory card

Type of memory card	easy500		easy700	
	read	write	read	write
M-8K	✓	–	✓	–
M-16K	–	–	✓	–
M-32K	✓	✓	✓	✓

Glossary

Analog input	The device easy-AB, easy-DA and easy-DC are provided with the two (easy500) and four (easy700) analog inputs I7, I8 and I11,I12. The input voltage range is 0 V to 10 V. The measuring data is evaluated with the integrated function relays.
Circuit diagram elements	As in conventional wiring, the circuit diagram is made up of circuit elements. These include input, output and marker relays, plus function relays and P buttons.
Connect mode	Connect mode is used to wire up the circuit elements in your easy circuit diagram.
Contact behaviour	The contact behaviour of any circuit element can be defined as either a break contact or a make contact. Break contact elements are identified by a line above the identifier (Exception: jump).
Entry mode	Entry mode is used to input or modify values when creating circuit diagrams or setting parameters, for example.
Function relays	Function relays can be used for complex control tasks. easy features the following function relays: <ul style="list-style-type: none"> • Timing relay • 7-day time switch • Year time switch • Counter, up/down, high-speed, frequency • Analog value comparator/threshold value switch • Operating hours counter • Master reset • Text marker relay

Impulse relay	An impulse relay is a relay which changes its switching state and retains its new state (latched) when a voltage is applied to the relay coil for a short time.
Input	<p>The inputs are used to connect up external contacts. In the circuit diagram, inputs are evaluated via contacts I1 to I12 and R1 to R12.</p> <p>easy-AB, easy-DA and easy-DC can also receive analog data via the inputs I7, I8 and I11, I12.</p>
Interface	<p>The easy interface is used to exchange and save circuit diagrams to a memory card or PC.</p> <p>Each memory card contains one circuit diagram and its associated easy settings.</p> <p>The EASY-SOFT-BASIC software allows you to control easy from your PC which is connected using the easy-PC-CAB cable.</p>
Local expansion	I/O expansion with the expansion unit (e.g. EASY620-DC-TE) installed directly on the basic unit. The connector is always supplied with the expansion unit.
Memory card	<p>The memory card is used to store your easy circuit diagram, together with its parameter and easy settings. The data on the memory card will be retained, even if the power supply fails or is switched off.</p> <p>The memory card is inserted into the interface slot on the easy device.</p>
Mode	easy has two operating modes: RUN and STOP. RUN mode is used to process your circuit diagram (with the controller running continuously). In STOP mode you can create your circuit diagrams.

Operating buttons

easy has eight operating buttons. These are used to select menu functions and create circuit diagrams. The large round button in the middle is used to move the cursor.

DEL, **ALT**, **ESC** and **OK** all perform additional functions.

Output

You can connect various loads to the four easy outputs, such as contactors, lamps or and motors. In the easy circuit diagram the outputs are controlled via the corresponding output relay coils Q1 to Q8 or S1 to S8.

P buttons

The P buttons can be used to simulate four additional inputs which are controlled directly by the four cursor buttons, rather than via external contacts. The switch contacts of P buttons are connected up in the circuit diagram.

Parameters

Parameters enable the user to set the behaviour of a function relay. Possible values include switching times or counter setpoints. They are set in the parameter display.

Power supply

easy-AB is supplied with an 24 V AC supply. The terminals are labelled "L" and "N".

easy-AC is powered by AC voltage at 85 to 264 V AC, 50/60 Hz. The terminals are labelled "L" and "N".

easy-DA is supplied with a 12 V DC supply. The terminals are labelled +12 V and 0 V.

easy-DC is powered by DC voltage at 24 V DC. The terminals are labelled "+24 V" and "0 V".

The terminals for the power feed are the first three terminals on the input side.

Remote expansion	I/O expansion with the expansion unit (e.g. EASY620-DC-TE) installed up to 30 m away from the basic unit. The EASY200-EASY coupling unit is fitted to the basic unit. The input and output data is exchanged between expansion and basic unit via a two-wire cable.
Retention	<p>Data is retained even after the easy power supply is switched off (retentive data)</p> <p>The following data is retentive:</p> <ul style="list-style-type: none">• easy circuit diagram• Parameters, setpoint values• Texts• System settings• Password• Actual values of marker relays, timing relays, counters (selectable)
Retentive data	See Retention.
Rungs	Each line in the circuit diagram is a rung. easy500 and easy700 can take 128 rungs.

Index

	7-day time switch	
	Compatibility of parameters	282
<hr/>		
A	Ambient conditions	262
	Analog	
	Comparing two values	117
	Input	46, 283
	Input power supply	48
	Input, resolution	108
	Setpoint potentiometer	49
	Signals	47
	Value comparator	104
	Value comparator parameters, compatibility	281
	Value comparator, two-step controller	115
	Value scaling	139
	Analog input, power supply	48
	AND circuit	184
	Approvals	264
<hr/>		
B	Basic circuit	
	Maintained contact	184
	Negation	183, 184
	Parallel circuit	185
	Self-latching	188
	Series circuit	184
	Two-way circuit	187
	Basic circuits	183
	Break contact	78, 277
	Inverting	85
	Bus system	62
	Button	
	ALT	70
	DEL	70
	OK	68, 76

	Buttons	19
	Buttons for circuit diagram editing	75
C	Cable cross-sections	35
	Cable lengths	41
	Cable protection	35, 38
	Cables	35
	Changing channel (7-day time switch)	145
	Changing channel (year time switch)	176
	Changing the language	209
	Circuit diagram	77
	Checking	90
	Coil field	81
	Contact fields	81
	Creation, error handling	256
	Cycle	235
	Deleting	73
	Display	68, 81
	easy operation	236
	Elements	283
	Enter	66
	Evaluation	236
	Fast entry	73
	Grid	68, 81
	Internal processing	235
	Load	82, 246, 251, 252
	Operating buttons	75
	Overview	81
	Rungs	81
	Saving	82, 246, 249, 250, 252
	Testing	71, 90
	Wiring	70, 86
	Clock accuracy	264
	Clock battery backup time	264
	Clock, backup time	264
	Coil	78
	Coil field	81

Coil function	
Contactor	92
Impulse relay	95
Latching relay	96
Negate	93
Overview	91
Commissioning	63
Comparator functions	104
Compare function	
Equal to	112
Greater than	114
Greater than/equal to	113
Less than	110
Less than/equal to	111
Two analog values	117
Compatibility of parameters	281
Connect mode	283
Connecting	
20 mA sensor	51
AC voltage	36
Analog inputs	46
Analog setpoint potentiometer	49
Brightness sensor	49, 50
Bus system	62
Contactors and relays	53
DC voltage	37
Digital input	44
Expansion device	34
Frequency generators	51
High-speed counters	51
Input	39
Neon bulbs	42
Output	53
Power supply	35
Proximity switch	44
Pushbutton actuators and switches	44
Relay outputs	54
Temperature sensor	50
Transistor outputs	56
Connecting AC	36

Connecting DC voltage	37
Connecting frequency generators	51
Connecting the brightness sensor	50
Connecting the setpoint potentiometer	49
Connecting transistor outputs	56
Connection cross-sections	35
Connections	
Deleting	87
Contact	77, 83
Behaviour	283
Fields	81
First	69
List of all	277
Contact type	85
Change	84
Cursor buttons	89
Deleting	85
Enter	84
Inverting	70
Overview	78
Contactor function, inverse	93
Counter relay	117
Parameters	128, 133
Counter value automatic reset	122
Counter value manual reset	122
Counters	117, 122
Cascading	123
Compatibility of parameters	281
Counting frequency	120
Frequency	125
High-speed	51, 131
High-speed, circuit diagram evaluation	236
Maintenance	151
Operating hours	149
Retentive actual value	124
Scan for actual value = zero	123
Unit quantities	122
Counting unit quantities	122

Current	
Input	41, 46
Input current, increasing	43
Cursor buttons	19, 89
Activate	224
Deactivate	225
See P buttons	285
Cursor display	28, 76
Cycle	235
Cycle pulse	93, 94, 190
<hr/>	
D	
Date setting	213
Delay times	
For easy-AB, easy-DA, easy-DC	241
For easy-AC, easy-AB	240
For easy-DA, easy-DC	238
Inputs and outputs	238
Deleting retentive actual values	232
Detecting operating states	116
Device information	234
Device version	254
Dielectric strength	263
Dimensions	259
Display and operating unit	253
DST setting	214
<hr/>	
E	
easy overview	15, 16
EASY-SOFT	82, 252
Edge	
Falling	190
Falling, evaluate	93
Rising	190
Rising, evaluate	94
Electromagnetic compatibility (EMC)	263
Entry mode	283
Error handling	
During circuit diagram creation	256
see What happens If ...?	255
With events	258

Example circuits	191
Expanding easy	243
Expansion	243
Connecting	34
Detecting	244
Local	284
Monitoring	245
Remote	286
Transfer behaviour	244
Expansion units	59
<hr/>	
F Fixing brackets	33
Flashing	167
Frequency counters	125
Function block inputs, list of names	280
Function relays	77, 283
Counter, high-speed	131
Counters	117
Example	98
Frequency counters	125
List	277
List of all	278
List of names	279
Master reset	181
Operating hours counter	149
Overview	97
Parameters	211
Retention	230
Text display	137
Time switch	143, 174
Timing relays	154

I	Improper use	11
	Impulse relay	95, 189, 284
	Input	284
	Analog resolution	108
	Analog, power supply	48
	Connecting	39, 44
	Connecting analog inputs	46
	Contact	83
	Current	41, 46
	Current, increasing	43
	Delay setting	222
	Delay times	238
	Expanding	59
	Reaction time	244
	Technical data	266
	Terminals	83
	Voltage range	41, 46
	Inrush current limitation	43
	Inserting a new rung	70
	Inside	235
	Installation	31
	Interface	246, 284
	Interference	41
	Inverting	85
J	Jumps	171
L	Latching relay	96
	LED display	22
	List	
	Contacts	277
	Function relays	278
	Relay	279

M	Main menu	
	Overview	23
	Selection	20
	Maintenance meters	151
	Make contact	78, 277
	Inverting	85
	Marker relay	91, 237
	Markers	91
	Master reset	181
	Memory card	82, 248, 284
	Compatibility	248
	Deleting	251
	Inserting	248
	Reading	251
	Writing	250
	Menu	
	Changing menu level	68
	Changing the language	209
	Guidance	19
	Language setting	64
	Selecting main menu	20
	System menu selection	20
	Message	
	INVALID PROG	253, 256
	System	255
	Mode	284
	Changing	71
	Monitoring of expansion unit	245
	Mounting	31
	Screw fixing	33
	Top-hat rail	32

N	NAND circuit	185
	Neon bulbs	42
	NOT circuit	183, 184

O	Operating buttons	75, 285
	Operating hours counter	149
	Operating modes	65
	Operating unit	253
	Operation	19, 75, 76
	OR circuit	185
	Output	285
	Connecting	53
	Connecting relay outputs	54
	Connecting transistor outputs	56
	Contact	83
	Delay times	238
	Expanding	59
	Reaction time	244
	Relay	83
	Reset	182
	Overload	58
	Monitoring with EASY.-D.-T.	242
	Overview	12

P	P buttons	285
	Activate	224
	Activating and deactivating	224
	Deactivate	225
	See Cursor buttons	89
	Parameter display	76
	Timing relays	128, 133
	Parameters	285
	Change	210
	Changing the switching time	211
	Compatibility	281
	Display	210
	Function relays	211
	Inhibit access	211
	Power flow display	103
	Password	
	Activate	206
	Change	207
	Deactivate, see Unlocking easy	207
	Deleting	208
	Protection	203
	Protection removal	208
	Scope	205
	Setup	204
	PC connection	252
	Power flow display	72, 90, 103
	Power supply	35, 285
	AC voltage	36
	Analog input	48
	DC voltage	37
	Technical data	265
	Program	76
	Proper use	11

R	Reaction time for I/O	244
	Reed relay contacts	42
	Relay	77, 83
	Connecting analog outputs	54
	Contactor function	92
	Impulse	95
	List of all	279
	Name	84
	Negate	93
	Number	84
	Output, technical data	272
	Reset	96
	Set	96
	Timing	154
	Relay coil	
	Change	84
	Coil function	84, 91
	Deleting	85
	Enter	71, 84
	Relays	
	Overview	79
	Reset	96
	Reset markers	182
	Reset, master	181
	Retention	230, 286
	Memory	264
	Permissible markers and function relays	230
	Retention (non-volatile data storage)	230
	Retentive actual value, deleting	232
	Retentive behaviour	
	On circuit diagram transfer	233
	Setting	230
	Transfer	232
	RUN, start behaviour	65
	RUN/STOP changeover	71

Rungs	286
Add new	70
Change	86
Creating	86
Deleting	88
Insert	88
Position in circuit diagram	81
Running light	197
<hr/>	
S Scaling	139
Selecting the System menu	20
Self-latching	188
Sensor (20 mA) connection	51
Set	96
Setpoints	211
Setting summer time rule	215
Setting the cycle time	229
Setting the time	213
Settings	203
Shift register	193
Short-circuit	58
Monitoring with EASY..-D.-T.	242
Signals, analog	47
Single pulse	166
Stairwell lighting	199
Star-delta starting	191
Startup behaviour	225, 227
After the circuit diagram is deleted	226
Basic setting	226, 228
Card	227
Possible faults	227
Setting	225
With upload/download to card or PC	227
Status display	20, 21
Status image register	236
Switch contact	83
Contact name	84
Contact number	84
Switching on	63

T	Target readership	11
	Technical data	262
	General	262
	Inputs	266
	Power supply	265
	Relay output	272
	Transistor output	274
	Temperature sensor connection	50
	Terminals	35
	Text display	137
	Threshold value switch	104
	Tightening torque	35
	Time switch	143
	7-day	143
	Changing channel	145, 176
	Examples	146
	Year	174
	Timing relays	154
	Compatibility of parameters	282
	Flashing	167
	Off-delayed	162
	On/off delayed	164
	On-delayed	160
	Operating modes	157
	Single pulse	166
	Time units	157
	Top-hat rail	32
	Transfer behaviour, expansion devices	244
	Transfer cable	252
	Transistor output, technical data	274
	Two-step controllers	115
	Two-wire proximity switches	43
	Type reference	17
U	Unlocking easy	207
	Use, improper	11
	Use, proper	11
	Using a mounting plate	33

V	Value entry	19
	Versions	15
	Voltage range, input	41, 46

W	Weekday setting	213
	What happens If ...?	255
	Wiring	75
	Backwards	237
	Deleting	70
	Enter	70
	Wiring rules	92

X	XOR circuit	187
----------	-------------------	-----

Y	Year time switch	174
----------	------------------------	-----