

Potting Boxes

Plastic enclosure black 65 x 38 x 27 mm ABS

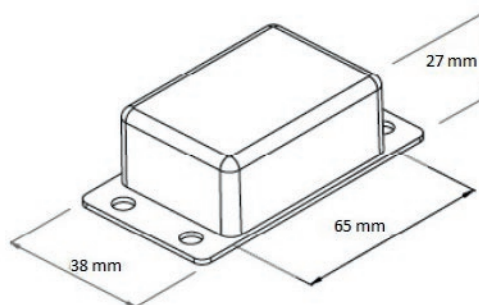

FEATURES:

With mounting lugs and 2 moulded cable entries

Highly resistant to most chemicals

High rigidity and impact strength

Compliant with water absorption to DIN53495

Maximum protection against shock, chemicals, moisture & temperature

SPECIFICATION:

Dimensions L x W x H	65 x 38 x 27 mm
Colour	black
Material	ABS
Mounting	Screws
Temperature range	max. +70 °C

PRODUCT RANGE:

Art. no.

RND 455-00055