

Diecast Boxes

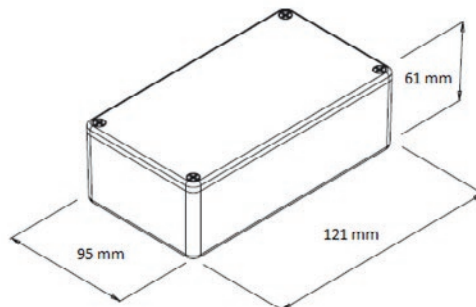

Metal enclosure grey 121 x 95 x 61 mm Die cast aluminium



FEATURES:

Highly durable robust aluminium diecast boxes with RFI shielding properties.

Lid & base diecast aluminium to ENAC 44200

Lid mounted by four M3 machine screws

Base, lid & x4 zinc plated M3 screw

Temperature resistant up to 260°C (without gasket)

Highly Durable and shock resistant

Vertical guides for PCB fixing

Optional neoprene gasket for IP65 seal

SPECIFICATION:

Colour	grey
Material	Die cast aluminium
Length	121 mm
Width	95 mm
Height	61 mm
Protection rating	IP 54
Dimensions L x W x H	121 x 95 x 61 mm

PRODUCT RANGE:

Art. no.

RND 455-00042