

---

Ceramic Vitreous Enameled

# RHEOSTATS



## DANOTHERM ELECTRIC A/S

### LEADING WITHIN PROFESSIONAL POWER RESISTORS

With roots back to 1919, Danotherm Electric A/S is known worldwide for its **qualified design** and production of **high quality** power resistors for the electronic-, the windpower- and the telecommunication industry. With distributors all over the world, Danotherm Electric A/S is ready to provide support and fulfill your demands for power resistors where ever you are.

Danotherm Electric A/S has its main factory in Copenhagen, Denmark. Furthermore a factory in Stargard, Poland and a factory in Milan, Italy.

Danotherm Electric A/S is a member of the Swedish NIBE Industrial Group providing access to all necessary production-, know-how- and sourcing facilities. Therefore Danotherm Electric A/S is able to solve all problems related to power resistors and helping our customers the optimum way.

The product range covers a wide field, from flat-, round- and wire wound resistors over aluminium housed compact brake resistors and Steel Grid Brake Resistors to huge modules constructed of water cooled break resistors. For further information please see all our resistor types here on our webpage [www.danotherm.dk](http://www.danotherm.dk).

## PRODUCT APPLICATIONS

### DANOTHERM PRODUCTS USED IN VARIOUS SOLUTIONS

Danotherm Power Resistors are used in connection with power electronic equipment. Some examples are: snappers, voltage dividers, de-charge resistors and start- or charging resistors.

An important application is brake resistors in connection with frequency converters for motor control. We can supply brake resistors as components for build-in or stand alone units.

Another application is heating elements, if high power solutions are requested or if brake energy can be re-used as heating energy.

## **DANOTHERM'S CONCEPT**

### **A RELIABLE PARTNER IN YOUR DAILY WORK**

Danotherm's concept is to represent the complete problem solver and reliable partner towards customers. With close customer relations and qualified counseling, Danotherm wishes to establish and maintain an optimal relationship to the customers.

Our key words are:

- > Quality
- > Flexibility
  - > Service
  - > Dynamics
  - > Creativity
    - > Economic solutions
    - > On time delivery

## **QUALITY MANAGEMENT**

Quality management is a natural part in the concept of Danotherm. Quality management is incorporated in a way that the most important part of quality management is built on self-control. Each single resistor is measured and controlled before dispatch. The coating is also checked for errors. The entire control process is incorporated at every step in the production to ensure the highest level of quality.

## **PRODUCT DEVELOPMENT**

Naturally product development is a key area for us. Dialogue with the customer and the satisfaction of her/his requirements is an important source of inspiration to us. It is this partnership which enables us to ensure that our customers and markets are always offered optimum solutions of the highest quality.

## **CERAMIC VITREOUS ENAMELED**

### **RHEOSTATS**

### **12 – 200W**

For more than 60 years Danotherm has produced this range of vitreous enameled Rheostats.

With a power range from 12W to 200W it covers most applications.

Below the standard versions are shown but many custom versions like

Off-positions with or without extra lugs

Tappings

Extended shafts

Locking devices and

Tandem and Triplex versions

are supplied



Danotherm has studied the RoHS directive 2002/95/EC in detail, including the Annex pos.7 and the Commission decision of 18 August 2005 Article



## TABLE OF CONTENT

Type 21/23 & 22/23 .....	6
Type 22/35.....	7
Type 21/40.....	8
Type 22/40.....	9
Type 22/50.....	10
Type 22/80.....	11
Type 22/120.....	12
Options .....	13
Application .....	14
Terms of delivery and sale for Danotherm Electric A/S.....	15

## Type 21/23 & 22/23

Average weight:	16g
Rotation 22/23	300 ±10 deg
21/23	270 ± 10 deg
Shaft 22/23	Ø 3mm
21/23	Ø 6mm
Required torque	50 - 390 pcm
Contact 22/23	copper-graphite
Contact 21/23	Silver

Type	Nom. Rating	Resistance Range		Rotation Angle ±10° DEG	Test Voltage AC 50 Hz V	Wiper Contact Material
		Rmin	Rmax			
21/23	12	3R9	10K	270	1500	Silver
22/23	12	3R9	10K	300	1500	Copper-graphite

### Mechanical Specification:

Type	21/23	22/23
D mm	22	22
H mm	17	17
d mm	6	3 (1/8")
G mm	M8 x 0,75	M6 x 0,75
B mm ± 1	6	6
L mm ± 1	15	15
T mm	3,2	3,2
A mm	16	16
Weight	16	16

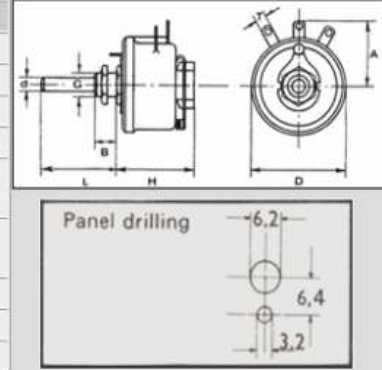

## Specifications

Power Range	12.5 W @25 °C
De-rating	100%@25°C - 75%@90°C
Environmental	-10°C - 70°C
Resistance Tolerance	± 10%
Max surface temperature	250 °C
Cooling media	Air
Connection	Solder; AMP; Screw.

## Type 22/35

Power	20W
Average weight:	60g
Rotation	280 ±10 deg
Shaft (standard)	Ø 6mm
Required torque	150 - 500 pcm
Contact (stand.)	copper-graphite

Type	Nom. Rating W	Resistance Range		Rotation Angle ±10° DEG	Test Voltage AC 50 Hz V	Wiper Contact Material
		Rmin	Rmax			
22/35	20	1R6	10K	270	2000	Copper-graphite

### Mechanical Specification:

Type	22/35
D mm	35
H mm	25
d mm *	6 (1/4")
G mm	M10 x 1
B mm ± 1	9
L mm ± 1	33
T mm	5
A mm	26
Weight	60

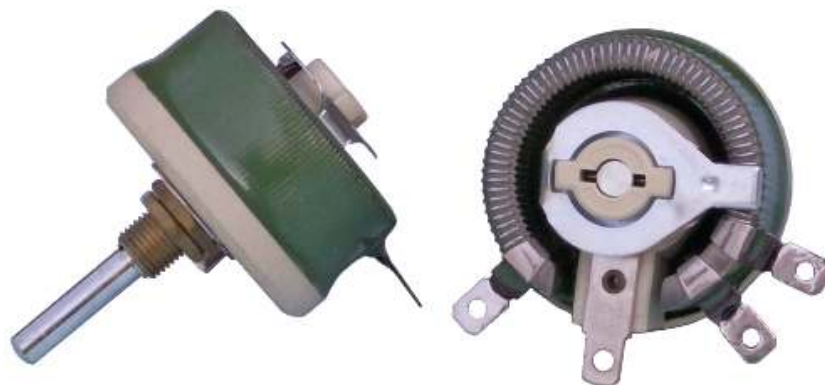
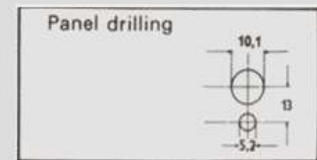
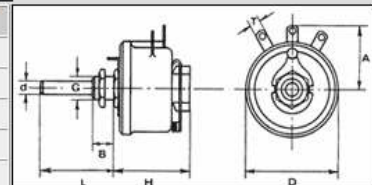

## Specifications

Power Range	20W @ 25 °C
Derating	100% @ 25 °C - 75% @ 90 °C
Resistance Tolerance	± 10%
Max surface temperature	260 °C
Cooling media	Air
Connection	Solder; AMP; Screw.

## Type 21/40

Power	30W
Average weight:	100g
Rotation	285 ±10 deg
Shaft (standard)	Ø 6mm
Required torque	150 - 500 pcm
Contact (stand.)	Silver

Type	Nom. Rating	Resistance Range		Rotation Angle ±10° DEG	Test Voltage AC 50 Hz V	Wiper Contact Material
		Rmin	Rmax			
21/40	30	1R0	10K	290	2000	Silver
22/40	30	1R0	10K	290	2000	Copper-graphite

### ***Mechanical Specification:***

Type	21/40	22/40
d mm *	6 (1/4")	6 (1/4")
G mm	M10 x 1	M10 x 1
T mm	6,3	6,3
A mm	27	27
Weight	100	100

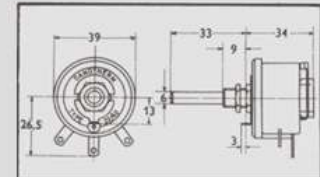

Panel drilling

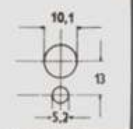

## Specifications

Power Range	30 W @25 °C
De-rating	100%@25°C - 75%@90°C
Environmental	-10°C - 70°C
Resistance Tolerance	± 10%
Max surface temperature	260 °C
Cooling media	Air
Connection	Solder; Screw; AMP.



## Type 22/40

Power	30W
Average weight:	100g
Rotation	285 ±10 deg
Shaft (standard)	Ø 6mm
Mounting	10 X 1 MG bushing
Required torque	150 - 500 pcm
Contact (stand.)	copper-graphite

Type	Nom. Rating	Resistance Range		Rotation Angle ±10° DEG	Test Voltage AC 50 Hz V	Wiper Contact Material
		Rmin	Rmax			
21/40	30	1R0	10K	290	2000	Silver
22/40	30	1R0	10K	290	2000	Copper-graphite

### Mechanical Specification:

Type	21/40	22/40
d mm *	6 (1/4")	6 (1/4")
G mm	M10 x 1	M10 x 1
T mm	6,3	6,3
A mm	27	27
Weight	100	100

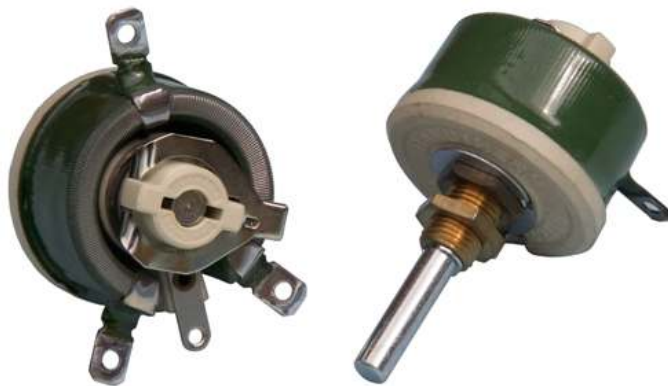
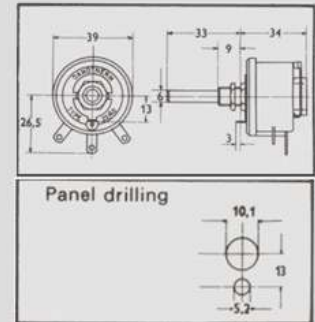

## Specifications

Power Range	30 W @25 °C
De-rating	100%@25°C - 75%@90°C
Environmental	-10°C - 70°C
Resistance Tolerance	± 10%
Max surface temperature	260 °C
Cooling media	Air
Connection	Solder; Screw; AMP.

## Type 22/50

Power	50W
Average weight:	120g
Rotation	285 ±10 deg
Shaft (standard)	Ø 6mm
Mounting	10 X 1 MG
Required torque	250 - 1000 pcm
Contact (stand.)	copper-graphite

Type	Nom. Rating W	Resistance Range		Rotation Angle ±10° DEG	Test Voltage AC 50 Hz V	Wiper Contact Material
		Rmin	Rmax			
22/50	50	1R0	10K	290	2000	Copper-graphite

### Mechanical Specification:

Type	22/50
D mm	51
H mm	37
d mm	6 (1/4)
G mm	M10 x 1
B mm ± 1	9
L mm ± 1	33
T mm	6,3
A mm	32
Weight	115

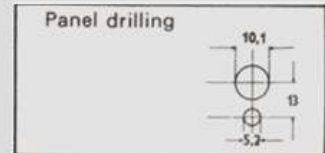
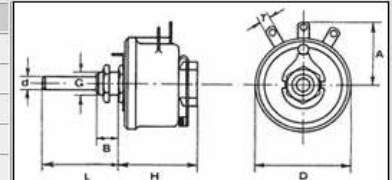

## Specifications

Power Range	50 W @ 25 °C
De-rating	100%@25°C - 75%@90°C
Environmental	-10°C - 70°C
Resistance Tolerance	± 10%
Max surface temperature	250 °C
Cooling media	Air
Connection	Solder; AMP; Screw.

## Type 22/80

Power	100W
Average weight:	300g
Rotation	285 ±10 deg
Shaft (standard)	Ø 6mm
Mounting	10 X 1 MG
Required torque	300 - 2000 pcm
Contact (stand.)	copper-graphite

Type	Nom. Rating W	Resistance Range		Rotation Angle ±10° DEG	Test Voltage AC 50 Hz V	Wiper Contact Material
		Rmin	Rmax			
22/80	100	R6	10K	290	2500	Copper-graphite

### Mechanical Specification:

Type	22/80
D mm	78
H mm	46
d mm	6 (1/4")
G mm	M10 x 1
B mm ± 1	9
L mm ± 1	33
T mm	10
A mm	51
Weight	275

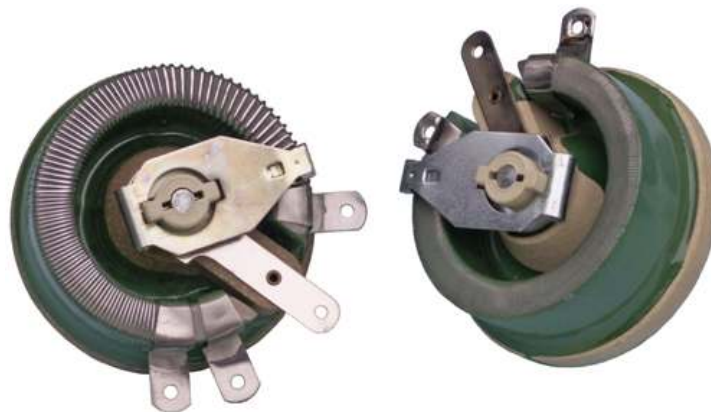
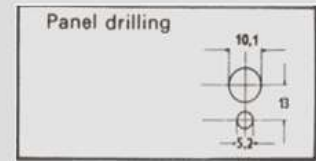
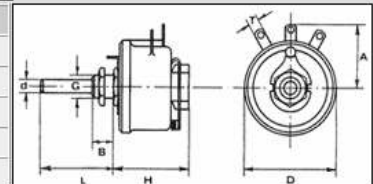

## Specifications

Power Range	100W @ 25 °C
De-rating	100%@25°C - 75%@90°C
Environmental	-10°C - 70°C
Resistance Tolerance	± 10%
Max surface temperature	310 °C
Cooling media	Air
Connection	Solder; Screw.

## Type 22/120

Power	200W
Average weight:	700g
Rotation	285 ±10 deg
Shaft (standard)	Ø 6mm
Mounting	10 X 1 MG
Required torque	300 - 3000 pcm
Contact (stand.)	copper-graphite

Type	Nom. Rating W	Resistance Range		Rotation Angle ±10° DEG	Test Voltage AC 50 Hz V	Wiper Contact Material
		Rmin	Rmax			
22/120	200	1R6	10K	290	2500	Copper-graphite

### Mechanical Specification:

Type	22/120
D mm	115
H mm	50
d mm *	6 (8)
G mm	M10 x 1
B mm ± 1	9
L mm ± 1	33
T mm	10
A mm	27
Weight	665

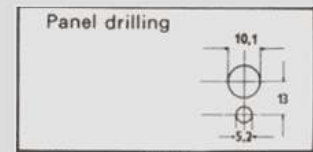
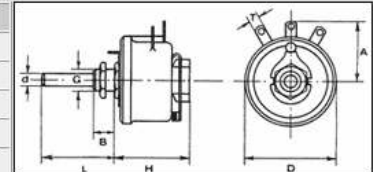

## Specifications

Power Range	200W @ 25 °C
De-rating	100%@25°C - 75%@90°C
Environmental	-10°C - 70°C
Resistance Tolerance	± 10%
Max surface temperature	310 °C
Cooling media	Air
Connection	Solder; Screw.

## Options



Tandem-triplex mountings..



Mounting boxes for table or wall are available for all rheostats.



Windings with wires of varying diameters (xsection winding) required to carry higher current at one end of the winding than at the other.



Off-position. All units can be supplied with an off-position at either end of winding.



All Danotherm rheostats can be supplied with spindles extended at the rear for ganging.



Tappings can be fitted on any model.



Locking device can be fitted.



Off-position with extra lug.

## Application

A rheostat is an adjustable or variable resistor. It is used to control the electrical resistance of a circuit without interrupting the flow of current. A rheostat has usually 3 terminals and consists of a resistive wire wrapped to form a toroid coil with a wiper that slides along the surface of the coil. It is designed with a ceramic core. Rheostats are used in applications that require high voltage and current.

There are still many applications that require a device that can be used to handle significant power and for these applications a rheostat is a very good choice. The most common uses today for rheostats are as:

- Light dimmers
- Motor speed controls
- In arc lamps
- Pumps
- Fans
- Blowers
- Respirators
- Dental and medical equipment
- Model trains



## Terms of delivery and sale for Danotherm Electric A/S

Unless otherwise agreed in writing, any sale shall be covered by the terms and conditions stated in the following:

### 1.0 OFFER

Unless otherwise expressly stated, the Seller's offer shall always be given without obligation and shall not be binding on the Seller until he has confirmed the order.

### 2.0 PRICES

2.1 An order shall be booked at the price applying when the order is placed.

2.2 If factors relating to costs necessitate price changes before delivery is made, the Seller reserves the right to change the price, or if the Buyer cannot accept the changed price to cancel the order without liability.

2.3 All prices quoted by the Seller are, unless otherwise expressly stated, exclusive of VAT, taxes and duties imposed on the relevant type of goods.

2.4 If packaging beyond the usual packaging is necessary, the cost's of such packaging shall be paid by the Buyer.

### 3.0 PAYMENT

3.1 If the Buyer does not observe the time of payment stated on the invoice, the Seller reserves the right to withhold further supplies until payment has been made. In such cases, the Seller shall be entitled to change the terms of payment.

3.2 If the time of payment is not observed, the Buyer shall pay interest at a rate of 1.5% per month or fraction thereof from the time of payment and until the amount has been received by the Seller.

### 4.0 DELIVERY AND DELAYS

4.1 Shipment of goods shall in all cases be at the Buyer's risk. Damage, shortage or delays occurred in transit shall therefore not be compensated by the Seller. The Buyer shall arrange insurance cover, unless otherwise agreed.

4.2 Return of goods delivered shall not be accepted.

4.3 At the delivery of goods special produced, the supplier has the right of delivering as much as 10% less and as much as 10% more than the quantity agreed on.

### 5.0 PRODUCT INFORMATION

5.1 Drawings, specifications, etc. handed out by the Seller before or after the conclusion of the agreement shall remain the property of the Seller and must not be passed on without written consent or be abused in any other ways.

5.2 The Seller reserves the right to make changes to the specifications agreed without notice if this can be done without inconvenience to the Buyer.

### 6.0 DEFECTS

6.1 If goods delivered can be shown to be defective, the Seller undertakes, at his own choice, to replace the defective article or remedy the defect. If the Seller offers to replace the article or remedy the defect, the Buyer shall not be entitled to cancel the agreement or to demand compensation because of replacement or remedy.

6.2 Any complaint shall be made by the Buyer in writing towards the Seller no later than 10 days after receipt of the goods. On the arrival of the goods, the Buyer shall arrange for the usual and necessary inspection of the goods. Complaints shall always be made before the goods delivered have been mounted or subject to any type of processing.

6.3 The Seller undertakes no responsibility for the suitability of the goods for the intended purpose.

6.4 The Seller shall not be liable for defects or shortages due to wrong treatment, transporting, storing, mounting, or any other kind of negligence on the part of any other party than the Seller.

### 7.0 FORCE MAJEURE

7.1 The following circumstances shall lead to freedom from liability when they occur after the conclusion of the agreement and prevent or postpone the fulfilment of the agreement: War and mobilisation, riots and unrest, natural disasters, strikes and lockout, shortage of goods and defects or delays in connection with delivery from sub suppliers, fire, lack of transport.

7.2 In such cases, the Seller shall be entitled to cancel the order or part of the order, or to deliver the article when the circumstances blocking the fulfilment has ceased to exist.

### 8.0 LIMITATION OF LIABILITY

8.1 Seller's liability to pay compensation shall be limited to 25% of the invoice amount for the article sold.

8.2 The Seller shall never be liable for consequential loss, loss of profit or other types of indirect loss in connection with the agreement, including indirect loss as a result of delays or defects in the article sold.

### 9.0 PRODUCT LIABILITY

9.1 The Seller shall not be liable for damage to real and/or personal property if the article delivered causes damage. The Seller shall only be liable for injury if it can be proved that the damage is due to defects or negligence on the part of the Seller.

9.2 The Seller shall never be liable for consequential loss, loss of time, profit or similar indirect loss.

9.3 To the extent that product liability is imposed on the Seller towards and third party, the Buyer shall be obliged to indemnify the Seller to the extent that the Seller's liability is limited under the terms of conditions stated above.

### 10.0 LEGISLATION AND VENUE

10.1 As a B2B supplier Danotherm Electric A/S can not CE-mark or supply CE conformity documents as a standard. Should this be required by a customer, this has to be negotiated since it will require a risk analysis based on the customers actual use of the resistor and the conditions under which, it is going to be used.

10.2 Any dispute between the parties in connection with the agreement shall be settled according to Danish law at the Seller's jurisdiction.

---

# Ω NIBE

Danotherm Electric A/S is a member of NIBE Industrier AB in the NIBE Element group.

NIBE is an international heating technology company with business operations organised in three separate business areas, NIBE Element, NIBE Energy Systems and NIBE Stoves.

NIBE Element is the market leader in Northern Europe and a leading international manufacturer of components and systems for electric heating and resistors.

NIBE Element's mission is to supply components and systems for electric heating and resistors to both manufacturers and users of heating products.