

Capacitor, film, 0.068 uF, +/-5% Tol, -55/+105C, General Purpose, 630 VDC@85C, Lead Spacing=15 mm

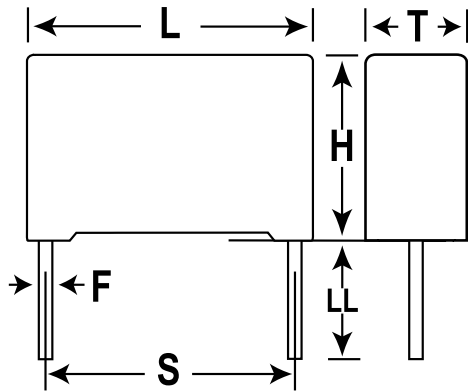

Dimensions (mm)		
Symbol	Dimension	Tolerance
L	18	+0.3
H	12	+0.1
T	6	+0.2
S	15	+/-0.4
LL	30	+5/-0
F	0.8	+/-0.05

Notes:

-L,H,T are nominal dimensions and do not imply a minimum.

General Information	
Supplier:	KEMET
Dielectric:	Metallized Polypropylene
Application:	General Purpose
Sub Application:	AEC-Q200
Style:	Radial Box
Lead Form:	Wire Leads
RoHS:	Yes

Specifications	
Capacitance:	0.068 uF
Voltage:	630 VDC
Tolerance:	+/-5%
Voltage AC:	250 VAC
Rated Temperature:	85C
Temperature Range:	-55/+105C
Dissipation Factor @ 1 kHz:	0.04%
Dissipation Factor @ 10 kHz:	0.06%
Dissipation Factor @ 100kHz:	0.25%
Insulation Resistance:	100 GOhm
Inductance:	10
Maximum dVdT:	1000 v/us
Miscellaneous:	Above 85C DC and AC voltage derating is 1.25%/C

Packaging Specifications	
Package Kind:	Bulk
Package Quantity:	900