

NAIS

SLIM, SPACE-SAVING 4-POINT UNIT RELAY WITH POWER PhotoMOS RELAY

RT-3 UNIT RELAY

(Power PhotoMOS Relay type)

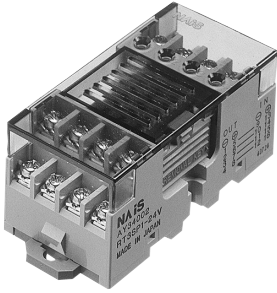

FEATURES

- **33 mm 1.299 inch wide space-saving type, with four independent points on a base measuring 33 × 67 mm 1.299 × 2.638 inch. Contributes to control panel and device downsizing.**
- **Equipped with Power PhotoMOS relays for high reliability and long life.** This type is equipped with Power PhotoMOS relays which have a reputation for high reliability and long life. Helps make devices maintenance-free.
- **Can be used mounted on a DIN rail or mounted directly (by screw).**
- **Equipped with an LED display to allow easy confirmation of operation.**
- **Incorporates a cross connection preventing diode.**
- **Relay installation and removal can be easily accomplished with the removal key accessory.**
- **Includes a cover as standard equipment for increased safety.**
- **The unit color of the Power PhotoMOS Relay type is pale lavender.** The unit color of the PA Relay type is titanium gray.

TYPES

Type	Rated input voltage	Part No.	Packing quantity	
			Inner carton	Outer carton
Power PhotoMOS Relay (DC only) (Equipped with AQZ102)	12 V DC	RT3SP1-12V	10 pcs.	100 pcs.
	24 V DC	RT3SP1-24V		
Power PhotoMOS Relay (AC/DC dual use) (Equipped with AQZ204)	12 V DC	RT3SP2-12V		
	24 V DC	RT3SP2-24V		

Note: Only for use with Power PhotoMOS standard type relays. Cannot be equipped with PA relays.

RATINGS

1. Input ratings (per relay)

Part No.	Rated input voltage	Operating voltage (at 25°C 77°F)	Restoration voltage (at 25°C 77°F)	Input current (during application of rated input voltage) (at 25°C 77°F)	Allowable variation of rated input voltage (at -20°C to +55°C -4°F to +131°F)
RT3SP1-12V	12 V DC	Max. 9.5 V DC (5.1 V typ.)	Min. 3.0 V DC (5.0 V typ.)	6.2 mA typ.	90% to 110% of rated input voltage
RT3SP2-12V					
RT3SP1-24V	24 V DC	Max. 15.0 V DC (6.8 V typ.)	Min. 3.5 V DC (6.5 V typ.)	6.7 mA typ.	
RT3SP2-24V					

Note: This product has a built-in input current limiting resistor; therefore, it is not necessary to externally connect a resistor to the input. The input voltage can be applied directly.

2. Output ratings (per relay, at 25°C 77°F)

Part No.	Equipped relay	Maximum load voltage	Recommended voltage	Continuous load current	Peak load current
RT3SP1-12V	AQZ102 (DC only)	60 V (DC)	0 to 30 V (DC)	2 A (DC)	9 A (100 ms 1 shot)
RT3SP1-24V					
RT3SP2-12V	AQZ204 (AC/DC dual use)	400 V (DC, AC peak value)	0 to 200 V (DC) 0 to 125 V (AC)	0.3 A (DC, AC peak value)	
RT3SP2-24V					

Notes: 1. During 4-point operation, the rating of each relay is also as shown above.

2. The load current varies depending on ambient temperature. Refer to the Load current vs. ambient temperature characteristic data.

PERFORMANCE

Item	Performance	
Breakdown voltage	Between input and output	2,000 Vrms for 1 min.
	Between different terminals (between relays, both ways)	1,500 Vrms for 1 min.
Insulation resistance	Min. 100 MΩ (Using 500 V DC megger, measuring same place as breakdown voltage.)	
Vibration resistance (destructive)	10 to 55 Hz at double amplitude 1 mm .039 inch	
Shock resistance (destructive)	Min. 196 m/s ² {20G}	
Ambient temperature	-20°C to +55°C -4°F to +131°F	
Ambient humidity	35% to 85% R.H. (Not condensing)	
Storage temperature	-30°C to +80°C -22°F to +176°F (Not freezing and condensing)	
Terminal screw fasten torque	0.3 to 0.5 N-m {3 to 5 kgf-cm}	
Cross connection protecting diode	1.5 A, inverse voltage 40 V	
Weight	Approx. 100 g 3.53 oz	

Notes: 1. The value of breakdown voltage and insulation resistance is the initial one.
 2. Condensing occurs when the unit relay is exposed to sudden temperature change in a high temperature and high humidity atmosphere. This may cause some troubles like insulation failure of the socket or the print circuit board. Take care under this condition.
 3. Below 0°C 32°F, condensing water can freeze and cause socket contact failures and other problems. Take care under this condition.

DATA

Load current vs. ambient temperature characteristics

Allowable ambient temperature: -20°C to +55°C
 -4°F to +131°F

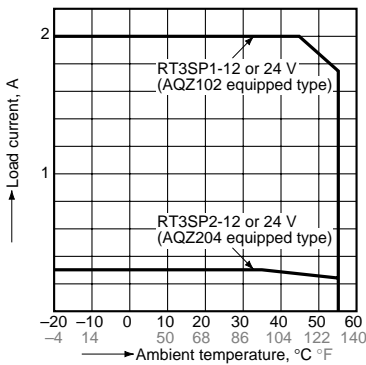

DIMENSIONS

mm inch

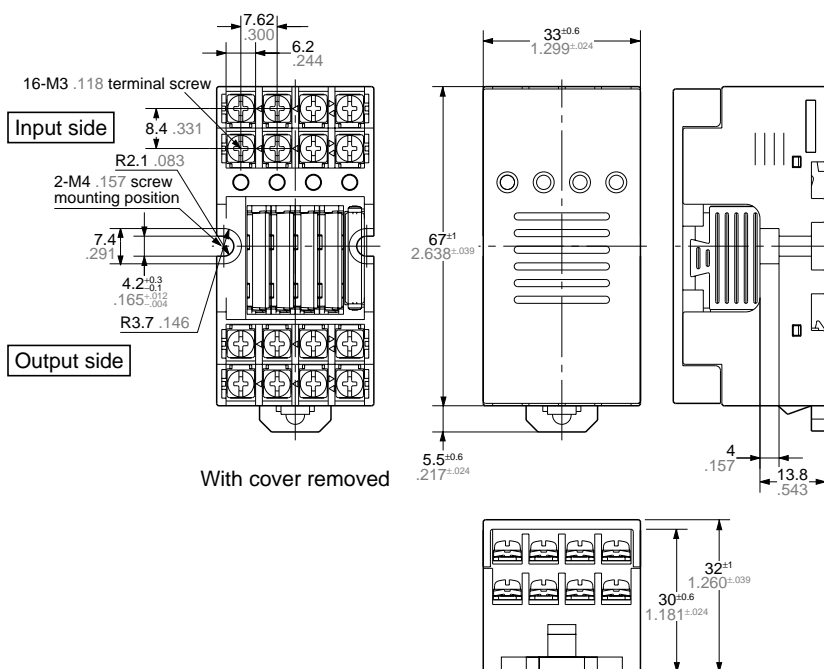

Schematic

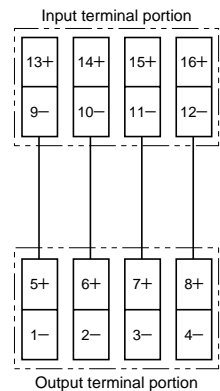

Note: The polarities of the output terminals are for the DC only type (equipped with AQZ102)

Panel cutout

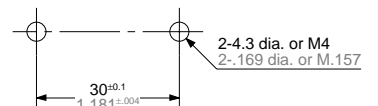

General tolerances ±0.3 ±.012

RT-3

CONNECTION TO TERMINALS

We recommend using wire-pressed terminals for connection to the terminal portion.

- **Applicable electrical wire**

0.25 to 1.65 mm² .01 to .065 inch

- **Applicable wire-pressed terminals**

mm inch

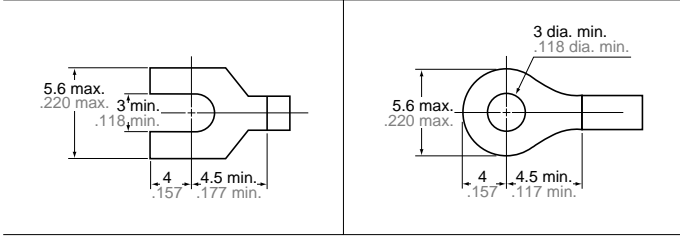

ACCESSORIES

mm inch

Short circuit plate

Use when you want to bridge terminals.

< With insulator >



AY3802

< Without insulator >



AY3803

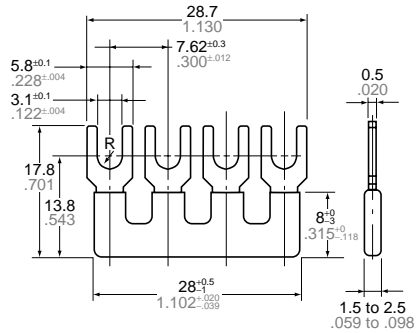

General tolerance $\pm 0.5 \pm .020$

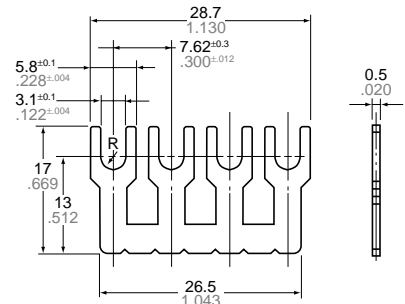

General tolerance $\pm 0.5 \pm .020$

CAUTIONS FOR USE

1. Operating environment

- 1) Keep the product as far away as possible from power cables, high tension equipment, power equipment, equipment with transmitting devices such as amateur radios, or equipment which generates a large switching surge.
- 2) The main unit is made of resin; therefore, do not use it in areas where it may come in contact with (or be exposed to) organic solvents such as benzene, thinner, and alcohol, or strong alkaline substances such as ammonia and caustic soda.
- 3) Do not use the product in areas where it may be exposed to flammable gases, corrosive gases, excessive dust, or moisture, or areas where it may be subjected to strong vibration or shock.

2. Dropping

If a unit is dropped or falls, be sure to check its external appearance and characteristics before using it.

3. Installing and removing the module

- 1) Firmly insert the module into the socket, with the terminals going in the direction of the blade receptacles.
 - 2) The module can be easily removed using the removal key.
- (1) Insert the removal key into the socket slots.

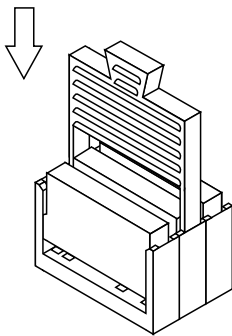

- (2) Pull the removal key up to remove the module.

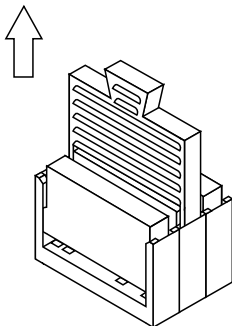

- (3) Slide the removal key off of the module.

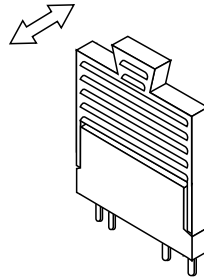

4. Wiring and circuit configuration

- 1) Perform wiring according to the internal schematic. Take care not to make any mistakes.

In particular, take care that the polarities of the output side of DC only type (equipped with AQZ102) are correct.

- 2) We recommend the use of wire-pressed terminals for connection to the terminal portion.

- 3) When the load is inductive, limit spike voltages generated from the load to less than the maximum load voltage.

Typical circuits are shown below. Add a clamp diode to the load.

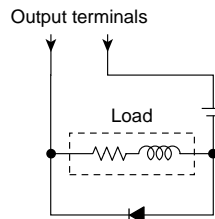

Add an R-C snubber to the load.

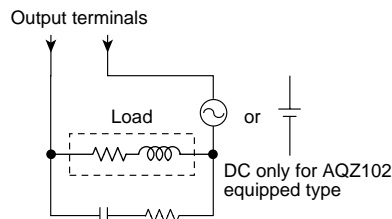

Add a varistor between the output terminals.

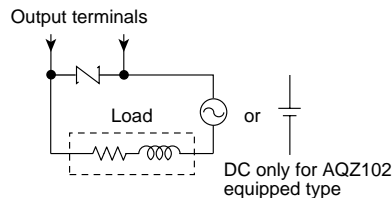

- 4) Even if spike voltages generated from the load are limited by a clamp diode or R-C snubber, inductances in long circuit wires will still create spike voltages. Keep wires as short as possible to minimize inductance.

5. Installation

- 1) Perform mounting hole cutout according to the panel cutout drawings.
- 2) When installing the unit on a DIN rail, use the DIN rail locking lever on the side of the unit. Installation is accomplished by simply fitting the unit onto the rail and pressing.

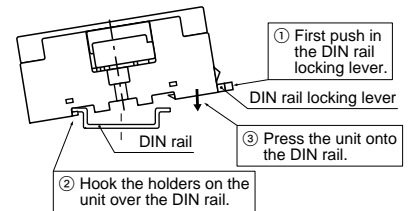

- 3) To remove the unit from the DIN rail, use a flat head screwdriver to pull out the DIN rail locking lever.

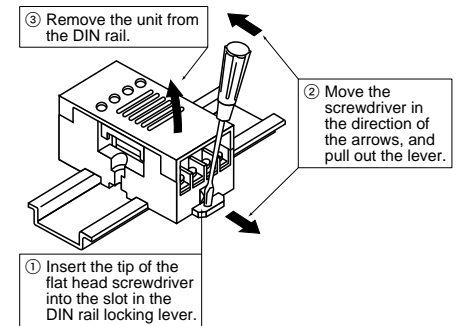

6. Transporting and storage

- 1) If the product is subjected to extreme vibration while being transported, the relays may become detached, the lead may become bent, and the unit may become damaged. Handle the inner and outer boxes with care.

- 2) If the product is stored in an extremely adverse environment, visible defects and deterioration of performance characteristics may result. We recommend the following storage conditions.

- Temperature: 5 to 30°C 41 to 86°F
- Humidity: Max. 60% R.H.
- Environment: No hazardous substances such as sulfuric acid gases and little dust.