

TOSHIBA Photocoupler GaAlAs Ired & Photo-Diode Array

TLP590B

Telecommunication
 Programmable Controllers
 Mos Gate Driver
 MOS FET Gate Driver

The TOSHIBA TLP590B consists of an aluminum gallium arsenide infrared emitting diode optically coupled to a series connected photo-diode array in a six lead plastic DIP package.
 TLP590B is suitable for MOS FET gate driver.

- UL recognized: UL1577, file No. E67349

Short Current

Type Name	Classification	Short Current		Marking Of Classification
		(min.)	I _F	
TLP590B	C20	20μA	10mA	20
	Standard	12μA		20, blank

(Note) Application type name for certification test, please use standard product type name, i.e.

TLP590B(C20): TLP590B

Maximum Ratings (Ta = 25°C)

Characteristics		Symbol	Rating	Unit
LED	Forward current	I _F	50	mA
	Forward current derating (Ta ≥ 25°C)	ΔI _F / °C	-0.5	mA / °C
	Pulse forward current (100μs pulse, 100 pps)	I _{FP}	1	A
	Reverse voltage	V _R	3	V
	Junction temperature	T _j	125	°C
Detector	Foward current	I _{FD}	50	μA
	Reverse voltage	V _{RD}	10	V
	Junction temperature	T _j	125	°C
Storage temperature range		T _{stg}	-55~125	°C
Operating temperature range		T _{opr}	-40~85	°C
Lead soldering temperature (10sec.)		T _{sol}	260	°C
Isolation voltage (AC, 1 min., R.H. ≤ 60%) (Note 1)		BVS	2500	Vrms

(Note 1) Device considered a two terminal device: Pins 1, 2 and 3 shorted together, and pins 4 and 6 shorted together.

Unit in mm

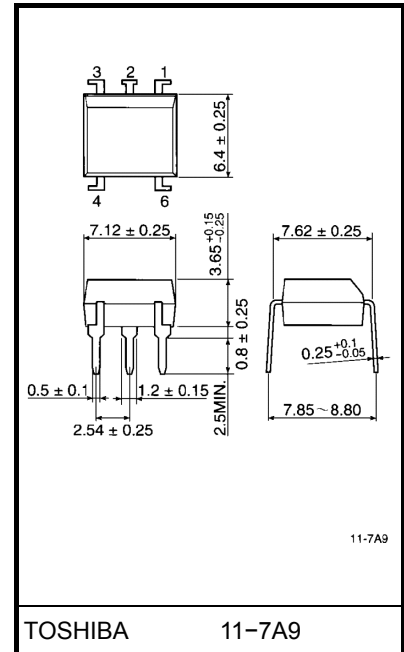

Weight: 0.39g

Pin Configuration(top view)

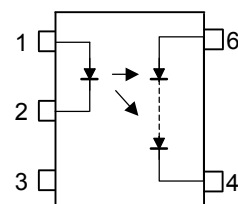

- 1. : Anode
- 2. : Cathode
- 3. : NC
- 4. : Cathode
- 6. : Anode

Recommended Operating Conditions

Characteristic	Symbol	Min.	Typ.	Max.	Unit
Forward current	I_F	—	20	25	mA
Operating temperature	T_{opr}	-25	—	85	°C

Individual Electrical Characteristics (Ta = 25°C)

Characteristic		Symbol	Test Condition	Min.	Typ.	Max.	Unit
LED	Forward voltage	V_F	$I_F = 10 \text{ mA}$	1.2	1.4	1.7	V
	Reverse current	I_R	$V_R = 3 \text{ V}$	—	—	10	μA
	Capacitance	C_T	$V = 0, f = 1 \text{ MHz}$	—	30	60	pF
Detector	Forward voltage	V_{FD}	$I_{FD} = 10 \mu\text{A}$	—	7	—	V
	Reverse current	I_{RD}	$V_{RD} = 10 \text{ V}$	—	1	—	nA
	Capacitance (anode to cathode)	C_{TD}	$V = 0, f = 1 \text{ MHz}$	—	—	—	pF

Coupled Electrical Characteristics (Ta = 25°C)

Characteristic	Symbol	Test Condition	Min.	Typ.	Max.	Unit
Open voltage	V_{OC}	$I_F = 10 \text{ mA}$	7.0	8.0	—	V
Short current	I_{SC}	$I_F = 10 \text{ mA}$	12	20	—	μA

Isolation Characteristics (Ta = 25°C)

Characteristic	Symbol	Test Condition	Min.	Typ.	Max.	Unit
Capacitance input to output	C_S	$V_S = 0, f = 1 \text{ MHz}$	—	0.8	—	pF
Isolation resistance	R_S	$V_S = 500 \text{ V}, \text{R.H.} \leq 60\%$	5×10^{10}	10^{14}	—	Ω
Isolation voltage	BV_S	AC, 1 minute	2500	—	—	Vrms
		AC, 1 second in oil	—	5000	—	—
		DC, 1 minute in oil	—	5000	—	Vdc

Switching Characteristics (Ta = 25°C)

Characteristic	Symbol	Test Condition	Min.	Typ.	Max.	Unit
Turn-on time	t_{on}	$I_F = 20 \text{ mA}, R_{SH} = 510 \text{ k}\Omega$ $C_L = 1000 \text{ pF}$ (Fig.1)	—	0.2	—	ms
Turn-off time	t_{off}		—	1	—	ms

Fig. 1 Switching time test circuit

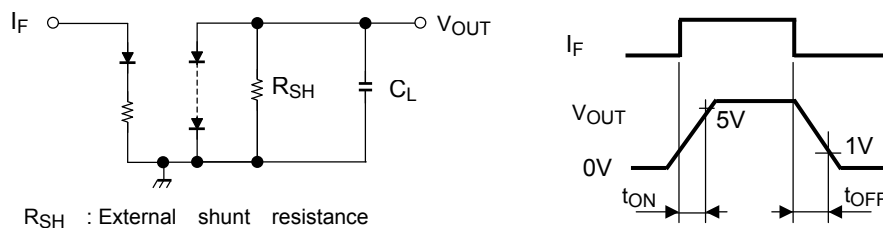

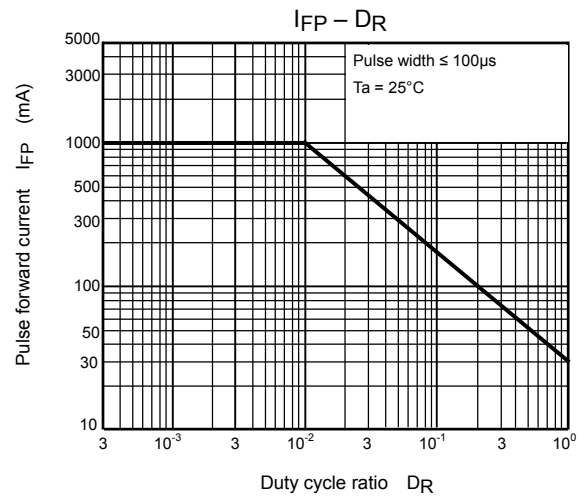
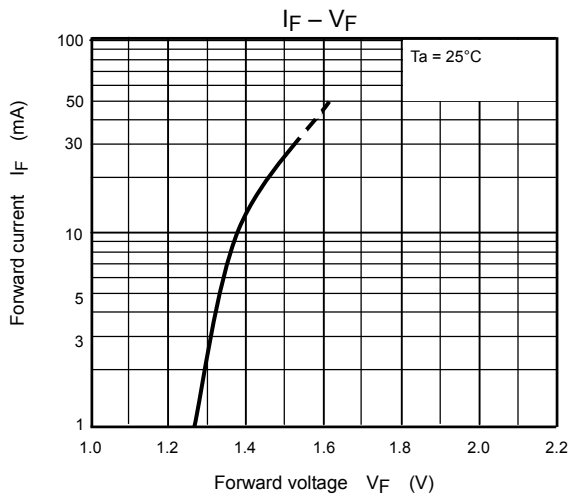
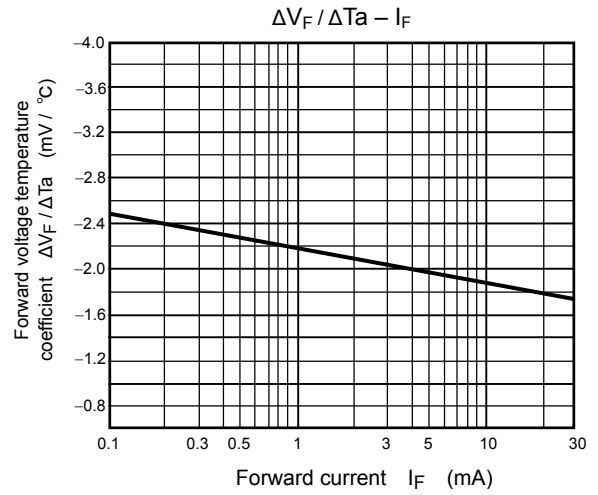
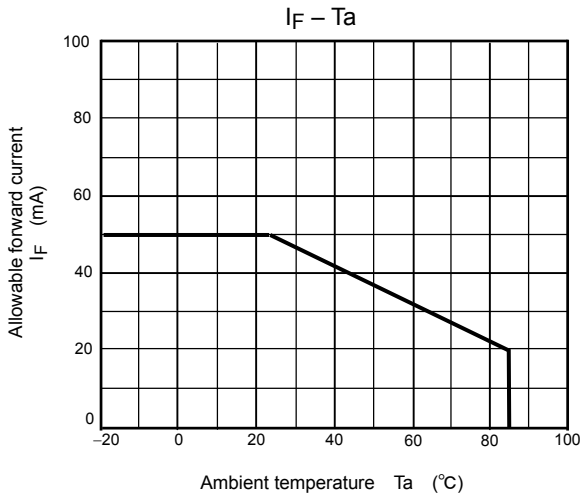

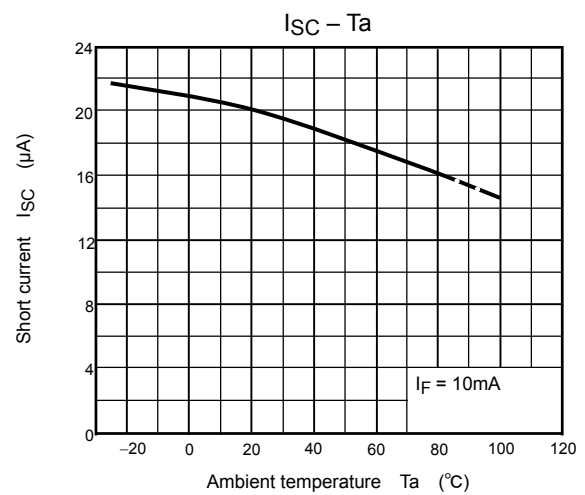
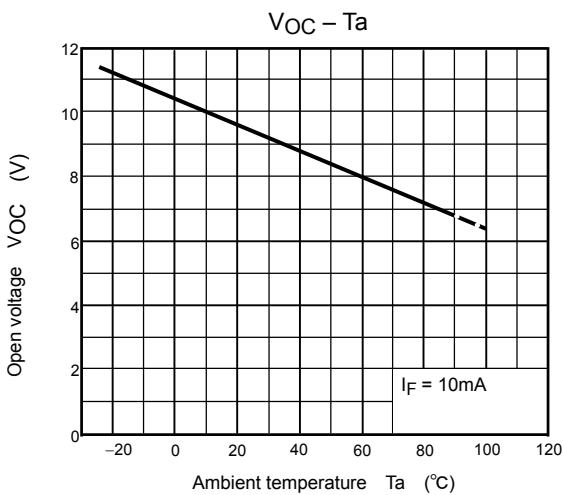
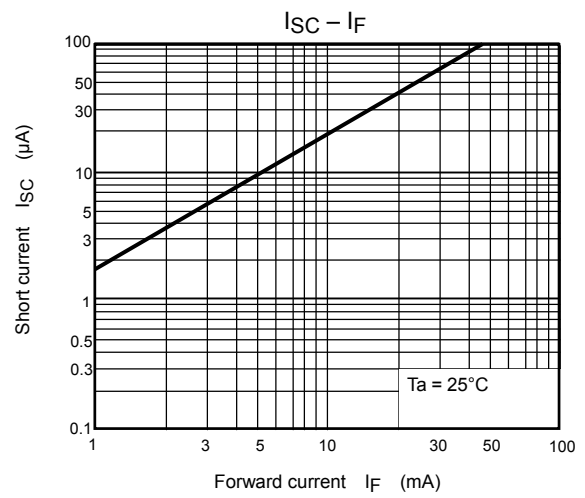
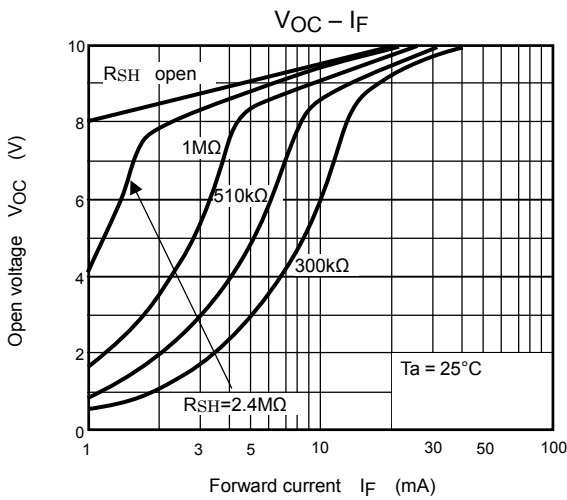
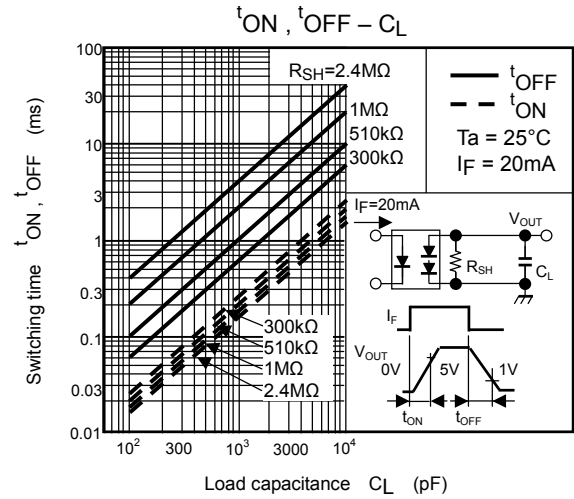
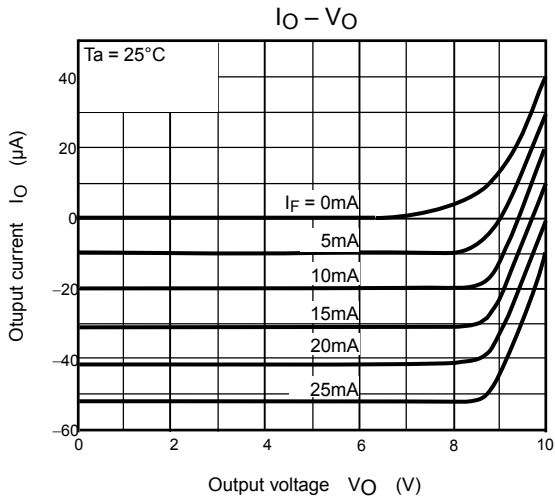

RESTRICTIONS ON PRODUCT USE

20070701-EN

- The information contained herein is subject to change without notice.
- TOSHIBA is continually working to improve the quality and reliability of its products. Nevertheless, semiconductor devices in general can malfunction or fail due to their inherent electrical sensitivity and vulnerability to physical stress. It is the responsibility of the buyer, when utilizing TOSHIBA products, to comply with the standards of safety in making a safe design for the entire system, and to avoid situations in which a malfunction or failure of such TOSHIBA products could cause loss of human life, bodily injury or damage to property.
In developing your designs, please ensure that TOSHIBA products are used within specified operating ranges as set forth in the most recent TOSHIBA products specifications. Also, please keep in mind the precautions and conditions set forth in the "Handling Guide for Semiconductor Devices," or "TOSHIBA Semiconductor Reliability Handbook" etc.
- The TOSHIBA products listed in this document are intended for usage in general electronics applications (computer, personal equipment, office equipment, measuring equipment, industrial robotics, domestic appliances, etc.). These TOSHIBA products are neither intended nor warranted for usage in equipment that requires extraordinarily high quality and/or reliability or a malfunction or failure of which may cause loss of human life or bodily injury ("Unintended Usage"). Unintended Usage include atomic energy control instruments, airplane or spaceship instruments, transportation instruments, traffic signal instruments, combustion control instruments, medical instruments, all types of safety devices, etc.. Unintended Usage of TOSHIBA products listed in this document shall be made at the customer's own risk.
- The products described in this document shall not be used or embedded to any downstream products of which manufacture, use and/or sale are prohibited under any applicable laws and regulations.
- The information contained herein is presented only as a guide for the applications of our products. No responsibility is assumed by TOSHIBA for any infringements of patents or other rights of the third parties which may result from its use. No license is granted by implication or otherwise under any patents or other rights of TOSHIBA or the third parties.
- GaAs(Gallium Arsenide) is used in this product. The dust or vapor is harmful to the human body. Do not break, cut, crush or dissolve chemically.
- Please contact your sales representative for product-by-product details in this document regarding RoHS compatibility. Please use these products in this document in compliance with all applicable laws and regulations that regulate the inclusion or use of controlled substances. Toshiba assumes no liability for damage or losses occurring as a result of noncompliance with applicable laws and regulations.