

# FIBER-OPTIC SENSORS

High precision in small spaces

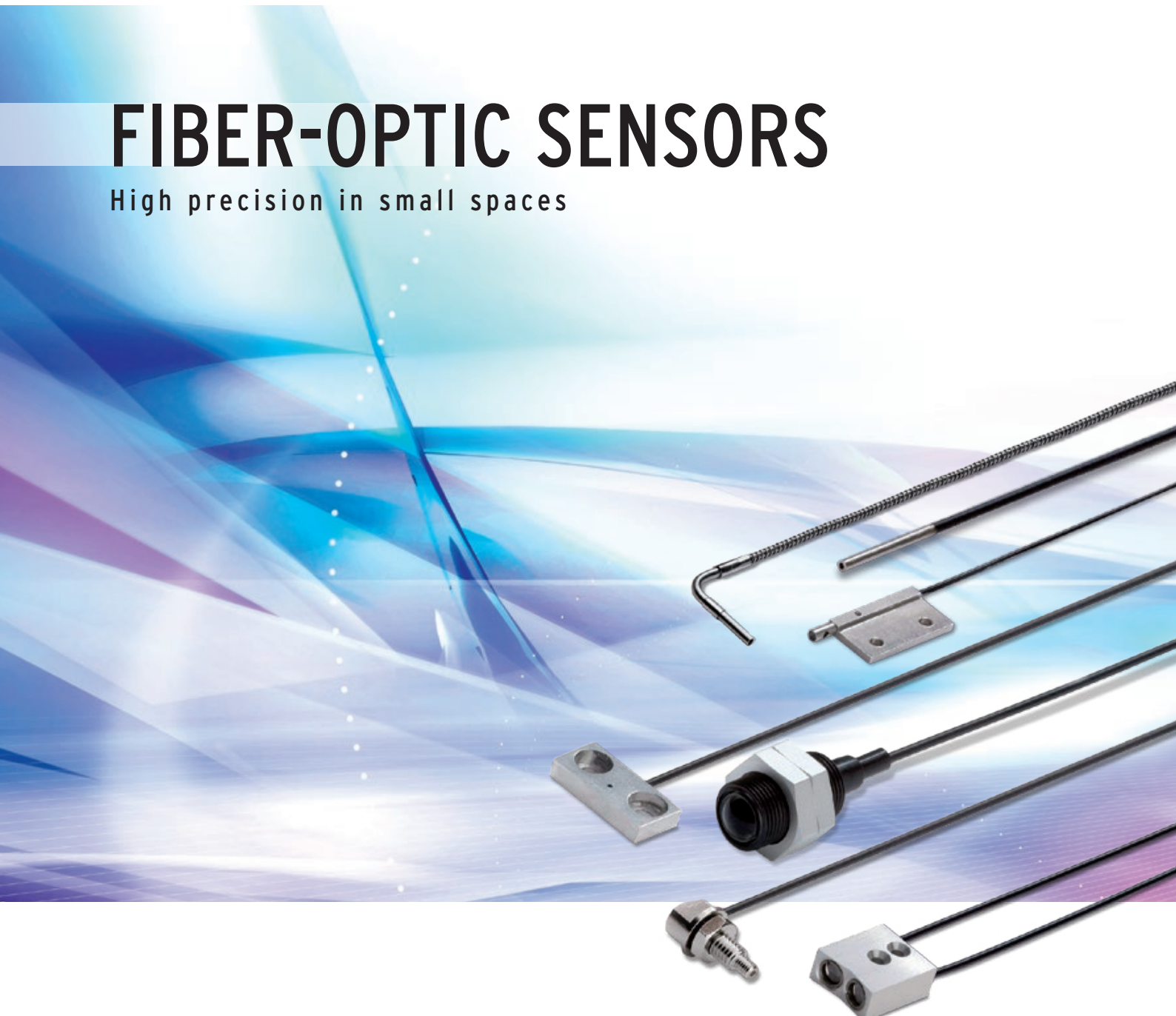

» Long operational life

» Wide portfolio range

» Easy to install and set up

# Precision and performance you can rely on

*For over 30 years OMRON has been a supplier of fiber optic solutions to leading manufacturers, especially in the semiconductor, the consumer electronics and the car electronics industry, as well as for food packaging and small plastic parts production.*

*The requirements for fiber optic solutions can be very demanding particularly for applications with extreme temperatures and aggressive chemicals for applications requiring highest precision in combination with limited mounting space or for applications requiring the reliable detection of a wide range of objects with different materials, shapes or colours.*

Today, already with over 500 standard, application or customer specific fiber optic sensors, we take pride in working together with you to ensure the best performance fit for your application.

Our global manufacturing network for fiber optic sensors in Ayabe (Japan), Shanghai (China) and Nufringen (Germany) focuses on continuously optimising methods for small and large volume production, applying stringent quality control procedures, and expanding production portfolio and flexibility to meet our customers' demands for flexibility, operational reliability, high accuracy and best application fit of our fiber optic sensors. Our goal is to provide precision and performance you can rely on.

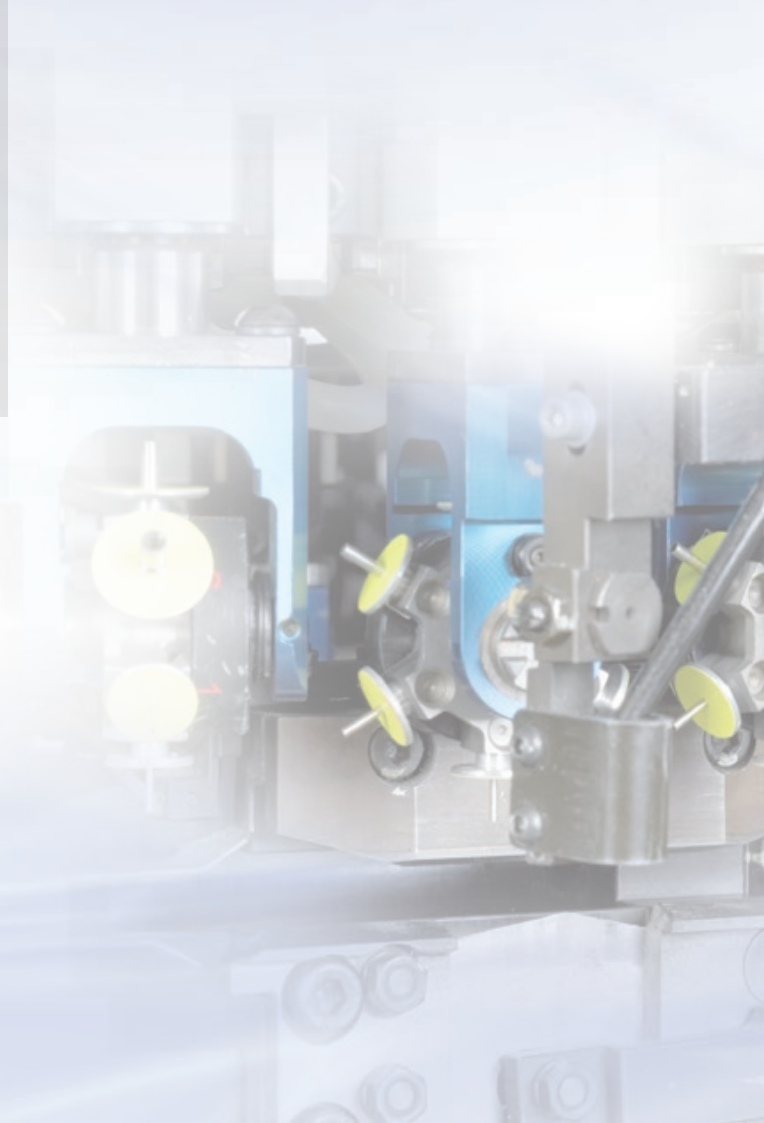

# Performance that makes a difference



## Long operational lifetime

Ensuring that products do not fail during production and require only minimal service attention enhances productivity and reduces maintenance costs.

### 1. Models with enhanced protection and tested resistance against harsh environments

- Tested resistance against aggressive chemicals, extreme temperatures, low pressure (vacuum), mechanical abuse

### 2. Preventing fiber breakage

- Housing construction preventing protruding cables (e.g. square shape, side view models)
- High flex fibers with 1 mm bending radius for close wall mounting
- Robot fibers tested with more than one million bending cycles
- Protective metal or plastic tubes

### 3. Operational stability

- LED power control against aging effects
- Auto-threshold control for enhanced compensation of power decrease, e.g. through dirt on lenses



## Easy to set up and adjust

With minimal time required for mounting the fibers the productivity can be enhanced for machine builders and the easy setting of the amplifiers simplifies production changes for machine users.

### 1. Easy-teach amplifiers or manual adjusters

- Easy manual adjustment by potentiometer
- One-button auto teach for in-process dynamic teaching, or two-point object teaching

### 2. Wide range of easy-to-mount fibers

- One-screw-mount fibers with hexagonal back
- Square shapes for simple surface mounting
- Side view for simple alignment
- Application-optimised housings (e.g. fork shape for label and foil detection, tube for liquid level detection, etc.)



## High accuracy in smallest size

OMRON's precise manufacturing processes with inspection system supported alignment of the fibers and lenses achieve minimal tolerance variations in all standard models and allow the detection of the smallest objects and height differences of less than 100  $\mu\text{m}$ .

- High beam axis accuracy for side view models through precise fiber bending or angle mirror surface treatment
- High spot evaluation precision on coaxial models through equal fiber distribution
- Accurate distance setting through precise lens and beam alignment



# The little extra

For your advanced application requirements, adaption to specific settings, or special solutions, our sales, application and engineering teams near you will provide additional service and support....what can we do for you?



## Application solution support

- Product selection and configuration support for best application fit and value for money
- Best practice tips & tricks for highest operational stability

## Product modifications

- Fiber length, material and type adaptations
- Fiber head material modifications



## Advanced connectivity and communication

- Remote teach
- Online parameter monitoring
- Connecting the amplifiers via field bus

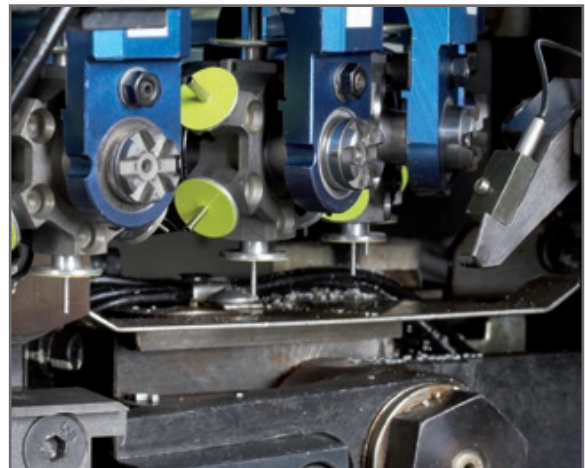

## Special solutions

- Application-specific configurations of focal lens, mounting head and fiber type
- Application-specific software, or parameter pre-configurations

# Choose the performance you need

## STEP 1: The fiber optic sensor heads

### General application



Standard cylindrical



Square shape



Miniature



Long distance

### Enhanced environment resistance



Chemical resistant



Heat resistant

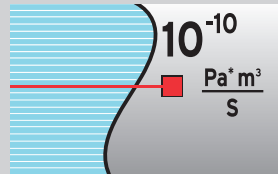

Vacuum resistant

### Special objects or installations

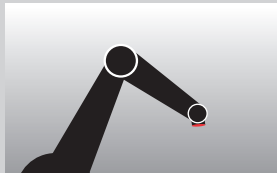

Robotic usage



Precision detection

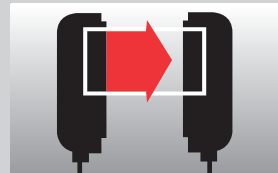

Area monitoring

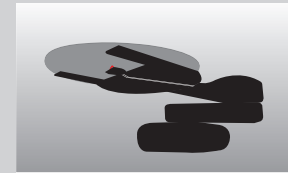

Special detection

### Accessories

Lenses, protective tubes, reflectors, installation aids

8

16

20

26

## STEP 2: The amplifiers

### Easy usage amplifier

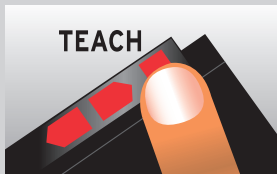

Easy-teach

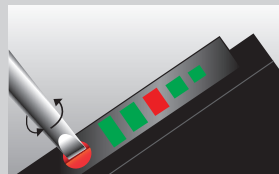

Potentiometer adjuster

### Advanced functionality amplifiers

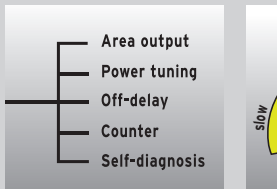

High Functionality

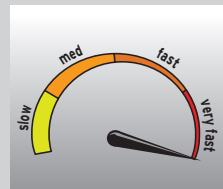

High speed



Colour mark detection

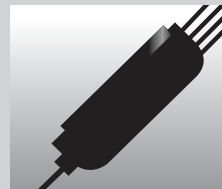

Double amplifier

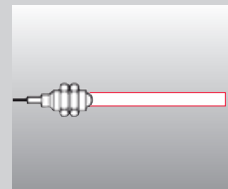

Infrared LED

27

31

## STEP 3: The little extra



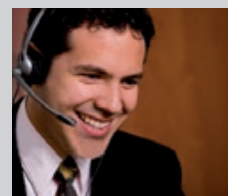

### The little extra

Application solution support, advanced connectivity and communication, modifications and special solutions.







# Selection table





## Fiber sensor heads

Type	Cylindrical	Square shape	Miniature	Longer distance	Chemical resistant
					
Model	E32 standard cylindrical	E32 square shape	E32 miniature	E32 longer distance	E32 chemical resistant
Key features	<ul style="list-style-type: none"> <li>Standard and high-flex fibers</li> <li>Sizes M3 to M6</li> </ul>	<ul style="list-style-type: none"> <li>3 or 4 mm thin housing</li> <li>Models in X,Y or Z-axis</li> <li>Direct mounting without bracket</li> </ul>	<ul style="list-style-type: none"> <li>Sizes from dia 500 µm to 3 mm</li> <li>Bendable sleeves</li> </ul>	<ul style="list-style-type: none"> <li>Built in focal lenses</li> </ul>	<ul style="list-style-type: none"> <li>Fluoroplastic cover or coating</li> </ul>
Through-beam	1,550 mm	1,550 mm	1,550 mm	20 m	4 m
Retro-reflective	250 mm	–	–	1.5 m	–
Diffuse-reflective	650 mm	600 mm	600 mm	1.4 m	350 mm
Page	8	10	12	14	16

Note: All sensing distances measured with E3X-DA-SE-S. Longer sensing distances up to 80% can be achieved with E3X-DA-S.

## Fiber amplifiers

Type	Easy teach/double display	Easy teach/single display	Potentiometer adjuster	High performance	Double amplifier
					
Model	E3X-HD	E3X-SD	E3X-NA	E3NX-FA	E3X-MDA
361°	PRO	LITE	LITE	PRO <sup>plus</sup>	n.a.
Key features	<ul style="list-style-type: none"> <li>Easy operation by smart tuning</li> <li>Dynamic power control</li> <li>Fieldbus connectivity</li> </ul>	<ul style="list-style-type: none"> <li>1 button object teaching</li> <li>Auto teach during operation</li> </ul>	<ul style="list-style-type: none"> <li>Easy adjustment by potentiometer</li> </ul>	<ul style="list-style-type: none"> <li>High functionality signal processing (timer, counter, dynamic power control, etc.)</li> <li>High signal resolution</li> <li>Increased sensing distance</li> <li>Double output/external input</li> <li>Fieldbus connectivity</li> </ul>	<ul style="list-style-type: none"> <li>2 inputs and AND, OR signal comparison</li> </ul>
Response time (min.)	1 ms (50 µs in super-high-speed mode)	1 ms	200 µs	1 ms (30 µs in super-high-speed mode)	1 ms (130 µs in high speed mode)
Page	27	30	31	32	35

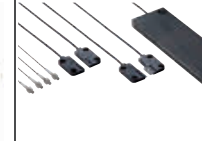
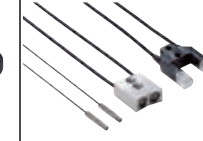
Heat resistant	Vacuum resistant	Robot applications	Precision detection	Area monitoring	Special application
					
<b>E32 heat resistant</b>	<b>E32 vacuum resistant</b>	<b>E32 robot</b>	<b>E32 precision detection</b>	<b>E32 area monitoring</b>	<b>E32 special</b>
<ul style="list-style-type: none"> <li>Heat resistant up to 400°C</li> </ul>	<ul style="list-style-type: none"> <li>Leakage rate of <math>1 \times 10^{-10}</math> Pa*m<sup>3</sup>/s max</li> </ul>	<ul style="list-style-type: none"> <li>Free moving multicore fibers for &gt;1 Mio bending cycles</li> </ul>	<ul style="list-style-type: none"> <li>Detection accuracy up to 100 µm</li> <li>Coaxial fibers</li> <li>Adjustable focal points</li> </ul>	<ul style="list-style-type: none"> <li>Area monitoring up to 70 mm</li> </ul>	<ul style="list-style-type: none"> <li>Detection of special objects (wafer, liquid level, flat glass, print mark ...)</li> </ul>
3 m	950 mm	1,350 mm	3.8 m	4 m	3.8 m
–	–	–	–	–	–
500 mm	–	350 mm	600 mm	300 mm	20 mm
17	19	20	21	23	24

High speed	Color/print mark detection	Infrared LED
		
<b>E3X-NA-F</b>	<b>E3X-DAC-S</b>	<b>E3X-DAH-S</b>
n.a.	n.a.	n.a.
<ul style="list-style-type: none"> <li>Short turn on time of 20 µs</li> </ul>	<ul style="list-style-type: none"> <li>White LED and RGB ratio comparison</li> </ul>	<ul style="list-style-type: none"> <li>Infrared LED</li> </ul>
20 µs	1 ms (60 µs in super high speed mode)	1 ms (55 µs in super high speed mode)
36	37	39



### Standard cylindrical fiber sensor heads

The standard cylindrical fiber optic sensor heads provide reliable object detection, easy installation and long sensor lifetime for all general applications.

- High-flex fibers and 90° cable exit for fiber breakage prevention
- Models with hexagonal head for simplified one-nut mounting
- Sizes M3 to M6

### Ordering information

Sensor type	Size	Sensing distance (in mm) <sup>*1</sup>				Order code	
		Standard fiber		High-flex fiber		Standard fiber	High-flex fiber
		E3X-HD	E3NX-FA	E3X-HD	E3NX-FA		
	M4	1550	2300	1400	1400	E32-TC200 2M	E32-T11R 2M
	M3	450	670	130	190	E32-TC200E 2M	E32-T21R 2M
	dia 4 mm	1500	2300	-		E32-ETC220 2M	-
	M4	-		1000	1500	-	E32-T11N 2M
	M6	-		1200	1800	-	E32-LR11NP 2M
	M6	250	370	-		E32-R21	-
	M6	600	900	550	820	E32-DC200 2M	E32-D11R 2M
	M4	160	240	60	90	E32-D211 2M	E32-D211R 2M
	M3	160	240	150	220	E32-DC200E 2M	E32-D21R 2M
	M6	-		350	520	-	E32-D11N 2M
	M4	-		350	520	-	E32-D21N 2M
	dia 6 mm	220	300	100	150	E32-D14L 2M	E32-D14LR 2M

\*1 Sensing distance measured with Standard Mode



Specifications

Item	Standard					High Flex				
	E32-_C200 E32-_C220	E32-D14L	E32-_C200E	E32-D211	E32-R21	E32-_R E32-T11N E32-D11N	E32-D14LR E32-D211R	E32-D21N	E32-LR11NP	
Permissible bending radius	R25		R10			R1		R2		
Cut to length	Yes									
Ambient temperature	-40°C to 70°C									
Material	Head	Brass-nickel plated	Stainless steel	Brass-nickel plated	Stainless steel	Plastic (ABS)	Brass-nickel plated	Stainless steel	Brass-nickel plated	
	Fiber	PMMA								
	Sheath	Polyethylene coating					PVC coating			
Degree of protection	IEC 60529 IP67								IP50	



Hi-flex multicore fibers for flexibility in installation without fiber breakage

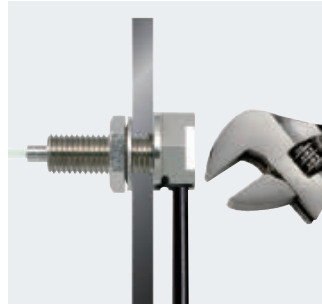

Models with hexagonal back for simple one-nut mounting

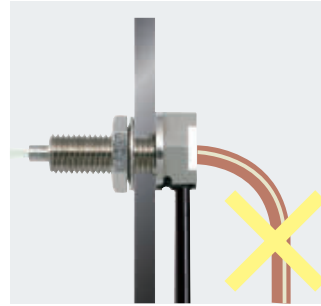

Cable exit shifted by 90° for preventing fiber breakage



**Square shape fiber sensor heads**

The fiber heads in square shaped housing provide fast and easy installation on flat surfaces.

- Models with sensing direction in X, Y or Z axis
- 3 or 4mm thick housings for minimal height requirement
- Standard or high-flex fibers

**Ordering information**

Sensor type	Size in mm (standard / high-flex)	Sensing distance (in mm) <sup>*1</sup>				Order code	
		Standard fiber		High-flex fiber		Standard fiber	High-flex fiber
		E3X-HD	E3NX-FA	E3X-HD	E3NX-FA		
	15×8×3 / 15×10×4	1550	1550	1400	2100	E32-T15X 2M	E32-ETS10R 2M
	15×8×3	950	1400	450	670	E32-T15Y 2M	E32-T15YR 2M
	15×8×3 / 15×9×4	950	1400	1300	1800	E32-T15Z 2M	E32-ETS14R 2M
	13×9×4	-		1300	1800	-	E32-ET15YR 2M
		-		1300	1800	-	E32-ET15ZR 2M
	15×10×3	600	900	350	520	E32-D15X 2M	E32-D15XR 2M
	15×10×3	200	300	100	150	E32-D15Y 2M	E32-D15YR 2M
	15×10×3 / 13×6×2.3	200	300	100	150	E32-D15Z 2M	E32-EDS24R 2M
	24.5×10×3	-		1780	2600	-	E32-A03-1 2M
	21×9×2	-		680	1000	-	E32-A04-1 2M

<sup>\*1</sup> Sensing distance measured with Standard Mode

Specifications

Item	Standard			High flex	
	E32- _15	E32-A03 _	E32-A04 _	E32-E	E32- _15_R
Permissible bending radius	R25	R10		R1	
Cut to length	Yes				
Ambient temperature	-40°C to 70°C				
Material	Head	Aluminium	Brass-nickel plated	Stainless steel	Aluminium
	Fiber	PMMA			
	Sheath	Polyethylene coating			PVC coating
Degree of protection	IEC 60529 IP67	IEC 60529 IP50		IEC 60529 IP67	

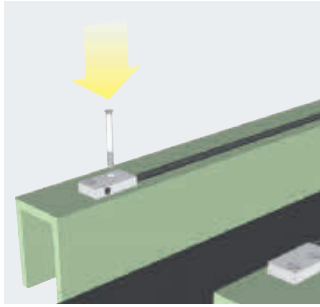

Space saving and fast mounting without additional brackets

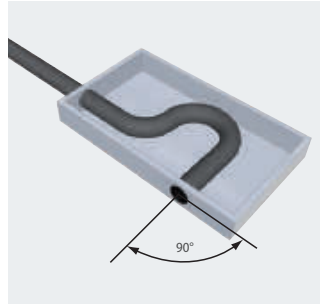

Precise positioning during manufacturing for 90° optics to achieve minimal tolerance variations in optical output axis angle



**Miniature fiber sensor heads**

The miniature fiber heads provide high accuracy in smallest spaces and reliable detection of minute objects.

- Sizes from dia 500 µm to 3 mm
- Side view models with precision axis alignment for highest accuracy
- Bendable sleeves for precision positioning

**Ordering information**

Sensor type	Size	Sensing distance (in mm) <sup>*1</sup>				Order code	
		Standard fiber		High-flex fiber		Standard fiber	High-flex fiber
		E3X-HD	E3NX-FA	E3X-HD	E3NX-FA		
	dia 3 mm	1550	2300	1000	1500	E32-T12 2M	E32-T12R 2M
	dia 2 mm	450	670	250	370	E32-T22 2M	E32-T22R 2M
	dia 1.5 mm	450	670	450	670	E32-T222 2M	E32-T222R 2M
	dia 1 mm	–	–	250	370	–	E32-T223R 2M
	dia 3 mm	950	1420	450	670	E32-T14L 2M	E32-T14LR 2M
	dia 2 mm	680	1020	–	–	E32-A04 2M	–
	dia 1 mm	250	370	100	150	E32-T24	E32-T24R 2M
	dia 1.2 mm	1550	2300	1000	1500	E32-TC200B <sup>*2</sup>	E32-TC200BR <sup>*2</sup>
	dia 0.9 mm	450	670	250	370	E32-TC200F <sup>*2</sup>	E32-TC200FR <sup>*2</sup>
	dia 3 mm	160	240	60	90	E32-D22 2M	E32-D22R 2M
	dia 2 mm	150	220	80	120	E32-D32 2M	E32-D32R 2M
	dia 1.5 mm	–	–	60	90	–	E32-D22B 2M
	dia 2 mm	60	90	30	40	E32-D24	E32-D24R 2M
	dia 2.5 mm	600	900	350	520	E32-DC200B 2M <sup>*2 *3</sup>	E32-DC200BR <sup>*2 *3</sup>
	dia 1.2 mm	160	240	60	90	E32-DC200F <sup>*2</sup>	E32-DC200FR <sup>*2</sup>
	dia 0.8 mm	–	–	30	40	–	E32-D33 2M
	dia 0.5 mm	–	–	6	9	–	E32-D331 2M

<sup>\*1</sup> Sensing distance measured in Standard Mode

<sup>\*2</sup> Models with 40 mm sleeve instead of 90 mm sleeve are available by adding '4' to the order code at the end, e.g. E32-TC200B4

<sup>\*3</sup> Sleeve cannot be bent



Specifications

Item	Standard						High-flex					
	E32-DC200B E32-T12 E32-TC200B	E32-T14L	E32-D32	E32-D22 E32-T222 E32-TC200F	E32-D24 E32-DC200F E32-T22 E32-T24	E32-A04	E32-D32R E32-D33 E32-D331	E32-D22B	E32-DC200BR E32-T12R E32-TC200BR	E32-D22R E32-T222R E32-TC200FR	E32-D24R E32-DC200FR E32-T14LR E32-T223R E32-T24R	
Permissible bending radius	R25			R10			R4		R1			
Cut to length	Yes											
Ambient temperature	-40°C to 70°C											
Material	Head	Brass-nickel plated	Stainless steel	Brass-nickel plated	Stainless steel	Brass-nickel plated	Stainless steel	Brass-nickel plated	Stainless steel	Brass-nickel plated	Stainless steel	
	Fiber	PMMA										
	Sheath	Polyethylene coating	PVC and polyethylene	Polyethylene coating	PVC and polyethylene	PVC coating	Polyethylene coating	PVC and polyethylene	PVC coating	Polyethylene coating	Polyethylene coating	
Degree of protection	IEC 60529 IP67					IEC 60529 IP50	IEC 60529 IP67					

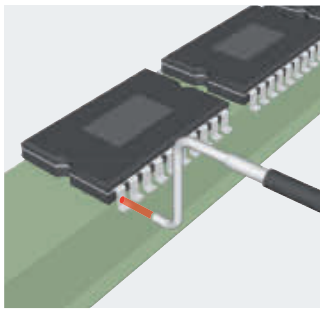

Bendable metal sleeves for precision positioning of sensors after installation

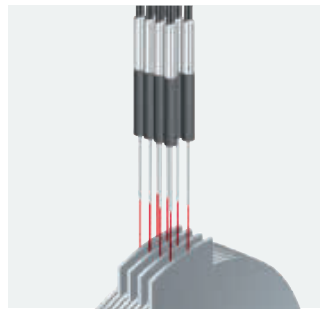

0.5 mm diameter (diffuse reflective) or 1 mm diameter (through beam) when mounting space is crucial

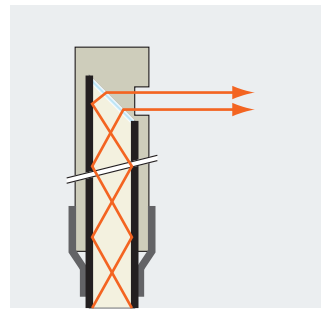

High precision fiber surface cutting and positioning during manufacturing to achieve minimal deviation of optical output axis angle



**Longer distance fiber sensor heads**

With built-in focal lenses the longer distance fiber heads provide enhanced operational stability in dusty environments or long distance applications

- Sensing distance up to 20 m
- Built-in focal lens
- Sizes from dia 2 mm to M14
- Easy installation - no need to attach auxiliary lenses

**Ordering information**

Sensor type	Size	Sensing distance (in mm) <sup>*1</sup>				Order code	
		Standard fiber		High-flex fiber		Standard fiber	High-flex fiber
		E3X-HD	E3NX-FA	E3X-HD	E3NX-FA		
	M14	20000	20000	-	-	E32-T17L	-
	25.2 × 10.5 × 8 mm	4000	4000	-	-	E32-T14	-
	M4	-	-	3500	4000	-	E32-LT11N 2M
	M4	4000	4000	3500	4000	E32-LT11 2M	E32-LT11R 2M
	M3	1350	2000	-	-	E32-TC200A 2M	-
	dia 3 mm	2600	3900	-	-	E32-T12L 2M	-
	dia 2 mm	850	1200	-	-	E32-T22L 2M	-
	21.5 × 27 × 10 mm	1500	2250	-	-	E32-R16 2M	-
	M6	-	-	350	520	-	E32-LD11N 2M
	22 × 17.5 × 9 mm	1400	2100	-	-	E32-D16 2M	-
	M6	360	540	350	520	E32-LD11 2M	E32-LD11R 2M
	M4	260	390	-	-	E32-D21L 2M	-
	dia 3 mm	450	670	-	-	E32-D12 2M	-

<sup>\*1</sup> Sensing distance measured in Standard Mode

## Specifications

Item	Through-beam							
	E32-T17L/ E32-T14	E32-LT11N	E32-LT11	E32-T12L	E32-TC200A	E32-LT11R	E32-T22L	
Permissible bending radius	R25	R2	R25			R1	R10	
Cut to length	Yes							
Ambient temperature	-40°C to 70°C							
Material	Head	ABS	Brass-nickel plated				Stainless steel	
	Fiber	PMMA						
	Sheath	Polyethylene coating						
Degree of protection	IP67	IP50		IP67		IP50	IP67	

Item	Retro-reflective		Diffuse-reflective					
	E32-R16	E32-D16	E32-LD11N	E32-LD11	E32-LD11R	E32-D21L	E32-D12	
Permissible bending radius	R25	R4	R2	R25	R10	R10	R25	
Cut to length	Yes							
Ambient temperature	-40°C to 70°C							
Material	Head	ABS	Aluminium	Brass-nickel plated			Stainless steel	
	Fiber	PMMA						
	Sheath	Polyethylene coating	PVC coating	Polyethylene coating				
Degree of protection	IP67	IP40	IP50			IP67		

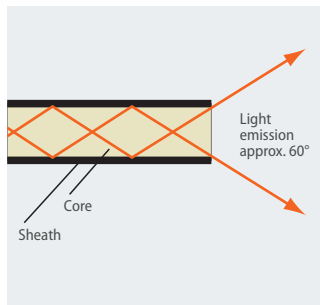

Light emission of conventional fibers

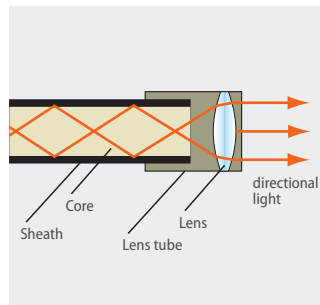

With built-in focal lenses, longer sensing distances can be achieved up to 5 times longer compared to conventional sensors

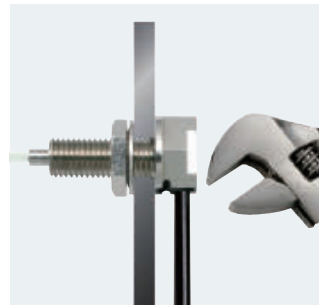

Models with hexagonal back for simple one-nut mounting

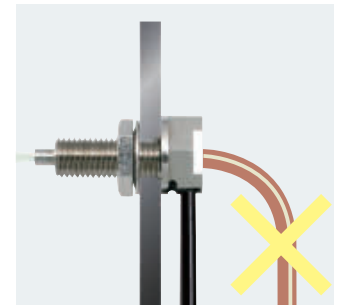

Cable exit shifted by 90° for preventing fiber breakage



### Chemical resistant fiber sensor heads

The chemical resistant fibers provide long sensor lifetime in areas with frequent cleaning, usage of chemicals and higher temperatures.

- fluororesin cover for highest chemical resistance
- temperature resistance up to 200°C

### Ordering information

Sensor type	Size	Sensing distance (in mm) <sup>*1</sup>		Key feature	Order code
		E3X-HD	E3NX-FA		
	M4	1350	2000	Fluororesin coating	E32-T11U 2M
	dia 5 mm	4000	4000	Fluororesin cover	E32-T12F
		800	1200		E32-T14F 2M
	M6	350	520	Fluororesin coating	E32-D11U 2M
	dia 7 mm	300	450	Fluororesin cover	E32-ED11F 2M
	dia 6 mm	190	280		E32-D12F
		80	120		E32-D14F 2M
	dia 5 mm	1400	2100	Fluororesin cover Heat resistant to 200°C	E32-T81F-S 2M
		2800	4000	Fluororesin cover Heat resistant to 150°C	E32-T51F 2M

<sup>\*1</sup> Sensing distance measured in Standard Mode

### Specifications

Item	Fluororesin coating		Full fluororesin cover		Full fluororesin cover and heat resistance		
	E32-T11U	E32-D11U	E32-ED11F	E32-_12F/E32-_14F	E32-T51F	E32-T81F-S	
Permissible bending radius (in mm)	R1	R4	R75	R40		R10	
Cut to length	yes					no	
Ambient temperature	-40°C to 70°C					-40°C to 150°C	-40°C to 200°C
Material	Head	Brass-nickel plated		Fluororesin			
	Fiber	PMMA				Glass	
	Sheath	Fluororesin coating		Fluororesin cover			
Degree of protection	IEC60529 IP67						

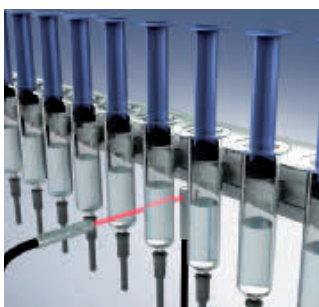

Enhanced temperature resistant models



Highest chemical resistance

The fluororesin cover provides highest chemical resistance for longest lifetime in frequently cleaned environments like aseptic filling in pharmaceutical applications





**Heat resistant fiber sensor heads**

The wide range of heat resistant fibers provides long sensor lifetime with the highest protection in demanding environments

- heat resistant up to 400°C
- sizes from dia 2 mm to M6
- models for long distances or high detection accuracy

**Ordering information**

Sensor type	Size	Sensing distance (in mm) <sup>*1</sup>		Key feature	Order code	
		E3X-HD	E3NX-FA		For E3NX-FA and E3X-HD amplifiers	For E3X-NA amplifier
	M4	3000	4000	-40°C to 150°C	E32-T51 2M	
		800	1200	-40°C to 100°C <sup>*2</sup> , high-flex	E32-T51R 2M	
		550	820	-40°C to 200°C	E32-T81R-S 2M	
		900	1350	-60°C to 350°C	E32-T61-S 2M	
	dia 2 mm	450	670	-40°C to 150°C	E32-T54 2M	
	dia 3 mm	2600	3900	-40°C to 200°C	E32-T84S-S 2M	
	M6	500	750	-40°C to 150°C	E32-D51 2M	
		280	420	-40°C to 100°C <sup>*2</sup> , high-flex	E32-D51R 2M	
		180	270	-40°C to 200°C	E32-D81R-S 2M	E32-D81R 2M
		180	270	-60°C to 350°C	E32-D61-S 2M	E32-D61
	M4	120	180	-40°C to 400°C	E32-D73-S 2M	E32-D73
	23×20×9 mm	15-38		-40°C to 150°C	E32-A09H 2M	
	30×24×9 mm	20-30		-40°C to 300°C	E32-A09H2 2M	
	25×18×5 mm	1-5		-40°C to 300°C	E32-L64 2M	
	36×18×5 mm	5-18			E32-L66 2M	

<sup>\*1</sup> Sensing distance measured in Standard Mode

<sup>\*2</sup> Short term resistance. For continuous operation -40°C to 90°C

Specifications

Item	-40°C to 150°C	-40°C to 100°C	-40°C to 150°C		-40°C to 200°C		-40°C to 300°C		-60°C to 350°C	-40°C to 400°C
	E32-_51	E32-D51R/T51R	E32-T54	E32-A09H	E32-_81_	E32-T84_	E32-A09H2	E32-L6_	E32-_61_	E32-D73_
Permissible bending radius (in mm)	R35	R2	R35		R10	R25				
Cut to length	Yes					No				
Material	Head	Brass-nickel plated	Stainless steel		Aluminium	Stainless steel				
	Fiber	PMMA	Acrylate resin	PMMA		Glass				
	Sheath	Fluoro resin	Polyurethane resin	Fluoro resin		Stainless steel spiral coating	Stainless steel tube	Stainless steel spiral coating		Stainless steel tube
Degree of protection	IEC 60529 IP67	IEC 60529 IP50	IEC 60529 IP67						IEC 60529 IP40	IEC 60529 IP67

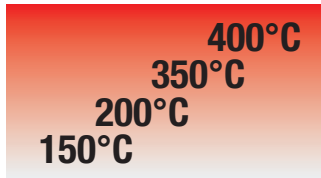

The temperature range optimised material selection provides best application fit and value - performance ratio.



Stainless steel spiral coating for flexibility with highest mechanical protection.



**Vacuum resistant fiber sensor heads**

For applications in cleanest and hot environments the vacuum resistant fibers and connecting flanges provide long operational lifetime and vacuum integrity.

- Leakage rate of  $1 \times 10^{-10}$  Pa\*m<sup>3</sup>/s max
- Heat resistance up to 200°C
- Detergent resistant fluororesin or stainless steel fiber sheath

**Ordering information**

**Sensor**

Sensor type	Size	Sensing distance (in mm) <sup>*1</sup>		Temperature range	Order code
		E3X-HD	E3NX-FA		
	M4	400	600	-40°C to 120°C	E32-T51V 1M
	dia 3	250	370	-40°C to 120°C	E32-T54V 1M
	dia 3	950	1400	-60°C to 200°C	E32-T845V 1M
	33 x 18 x 5.5 mm	5		-40°C to 70°C	E32-G86V-1 3M

\*1 Sensing distance measured with Standard Mode

**Flange**

Type	Size	Order code
4 channel flange	80 x 80 x 49 mm	E32-VF4
1 channel flange	96 x dia 30 mm max.	E32-VF1
Flange-to-amplifier connection fiber	2 m length	E32-T10V 2M

**Specifications**

Item	Fiber sensor heads				Flange-to-amplifier fiber
	E32-T51V	E32-T54V	E32-T845V	E32-G86V-1	E32-T10V
Permissible bending radius	R30		R25		
Cut to length	No				Yes
Material	Head	Aluminium	Stainless steel		-
	Fiber	Glass			PMMA
	Sheath	Fluororesin coating		Stainless steel spiral coating	Polyethylene coating
Degree of protection	-				

Item	Flange	
	E32-VF1	E32-VF4
Leakage rate	$1 \times 10^{-10}$ Pa*m <sup>3</sup> /s max	
Ambient temperature	-25°C to 55°C	
Material	Flange	Aluminium and stainless steel
	Seal	Fluorocarbon rubber (viton)

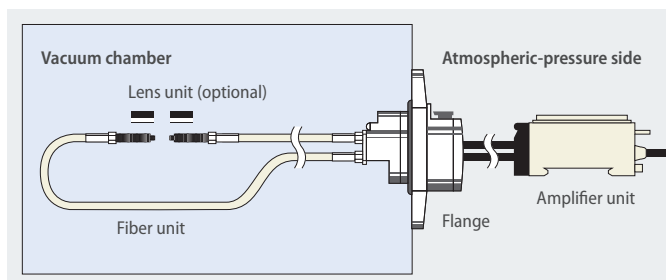

The vacuum resistant fiber heads and flanges are sealed to prevent gas leakage into vacuum areas



**Robot application fiber sensor heads**

For applications on frequently or fast moving parts, the robot fibers reduce the risk of fiber breakage with a guaranteed operational life of more than 1 million bending cycles

- Free moving multicore fibers for > 1 mio bending cycles
- Square shapes for easy surface installation
- Cylindrical sizes from dia 1.5 mm to M6

**Ordering information**

Sensor type	Size	Sensing distance (in mm) <sup>*1</sup>		Order code
		E3X-HD	E3NX-FA	
	M4	1350	2000	E32-T11 2M
	M3	400	600	E32-T21 2M
	dia 3 mm	1350	2000	E32-T12B
	dia 2 mm	400	600	E32-T221B
	dia 1.5 mm	400	600	E32-T22B
	15 x 18 x 3 mm	1350	2000	E32-T15XB 2M
	M6	350	520	E32-D11 2M
	M4	140	210	E32-D21B 2M
	M3	60	90	E32-D21 2M
	dia 1.5 mm	60	90	E32-D22B 2M
	15 x 10 x 3 mm	350	520	E32-D15XB 2M

\*1 Sensing distance measured in Standard Mode

**Specifications**

Item	Square		Cylindrical		
	E32-D15XB E32-T15XB		E32-T21	E32-D11 E32-T11	E32-D21 E32-T12B E32-T22B
Permissible bending radius	R4				
Cut to length	Yes				
Ambient temperature	-40°C to 70°C				
Material	Head	Aluminium	Brass-nickel plated		Stainless steel
	Fiber	PMMA			
	Sheath	PVC coating	Polyethylene coating	PVC coating	
Degree of protection	IEC 60529 IP67				

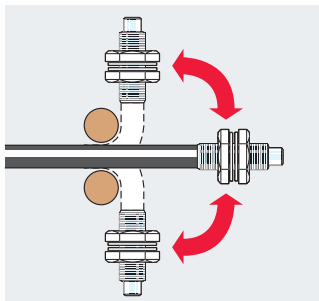

Guaranteed more than 1 mio bending operations

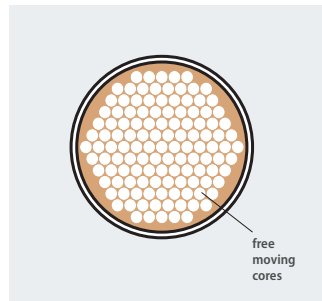

Free moving fiber cores prevent fiber breakage and light intensity loss when the fiber is bent.

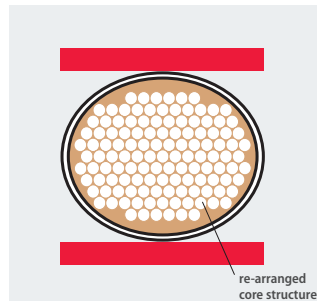





**Precision detection fiber sensor heads**

Highest precision in design and manufacturing of the fibers and focal lenses ensure superior beam and spot accuracy allowing the detection of the smallest objects and height differences, even down to 100 µm.

- Coaxial fibers with focal lenses for spot diameters of 100 µm
- Through-beam models with highly focused beam and precise optical axis alignment
- Limited reflective models for height difference detection of less than 100 µm

**Ordering information**

Sensor type	Preferred usage	Size	Key feature	Sensing distance*1 (in mm)		Order code
				E3X-HD	E3NX-FA	
	Precise thin object detection /accurate positioning	dia 3 mm	<ul style="list-style-type: none"> <li>• High precision optical axis adjustment</li> <li>• Very focused beam</li> </ul>	3800	4000	E32-T22S
		dia 2 mm		1780	2650	E32-A03 2M
				680	1000	E32-A04 2M
	Very small object detection	M6	–	600	900	E32-CC200 2M <sup>*2</sup>
		M3	Spot dia 0.5 mm	120	180	E32-C31 2M
			Spot dia 0.2 mm	17		E32-C41 1M + E39-F3B
			Spot dia 0.1 mm	7		E32-C41 1M + E39-F3A-5
		dia 3 mm	–	300	450	E32-D32L
		dia 2 mm	–	150	220	E32-D32 2M <sup>*2</sup>
		M6	<ul style="list-style-type: none"> <li>• 90° cable exit</li> <li>• Hexagonal back</li> </ul>	350	520	E32-C11N 2M
				M3	130	190
		M3	90° cable exit	50	70	E32-C31N 2M
			Spot dia 0.5 to 3mm	8 - 25 adjustable		E32-C31 2M + E39-EF51
Spot dia 0.5 to 1 mm	6 - 15 adjustable		E32-D32 2M + E39-F3A			
dia 2 mm <sup>*3</sup>	Spot dia 0.1 to 0.6 mm	6 - 15 adjustable		E32-C42 1M + E39-F3A		
	Precision height difference detection / flat surface detection Object detection in front of background	23 × 20 × 9 mm	–	26.5±11.5		E32-A09 2M
		16 × 18 × 4 mm	–	7.2±1.8		E32-L25L <sup>*2</sup>
		20 × 20 × 5 mm	–	3.3		E32-L25
		18 × 20 × 4 mm	Precise spot e.g. for detection of a flat / reflective surface	4±2		E32-L24L <sup>*2</sup>
		34 × 25 × 8 mm	High precision (detection accuracy 100 µm)	2.4		E32-EL24-1 2M
		20.5 × 14 × 3.8 mm	Limited reflective wide beam e.g. for object detection on a flat surface	15		E32-L16-N 2M

\*1 Sensing distance measured in Standard Mode  
 \*2 A high flex cable version is available. Add 'R' to the order code, e.g. E32-CC200R  
 \*3 Outer diameter of the fiber. Outer diameter of the focal lens is dia 4mm (front part)

Specifications

Item	Through-beam			Diffuse reflective (coaxial)				Limited reflective				
	E32-T22S	E32-A03	E32-A04	E32-C11N E32-C31N	E32-C21N	E32-CC200	E32-C42 E32-D32/-D32L E32-C31/-C41	E32-EL24-1	E32-L24L E32-L25L	E32-L25	E32-L16	E32-A09
Permissible bending radius	R10	R1	R10	R4	R2	R25		R10		R25		
Cut to length	Yes											
Ambient temperature	-40°C to 70°C											
Material	Head	Brass-nickel plated	Stainless steel	Brass-nickel plated			Brass nickel plated	Brass-nickel plated and aluminium	Polycarbonate	ABS	Aluminium	
	Fiber	PMMA										
	Sheath	PVC coating	Polyethylene coating		PVC coating		PVC, polyethylene and polyolefin coating	Polyethylene coating				
Degree of protection	IEC 60529 IP67	IEC 60529 IP50		IEC 60529 IP67				IEC 60529 IP50			IEC 60529 IP40	

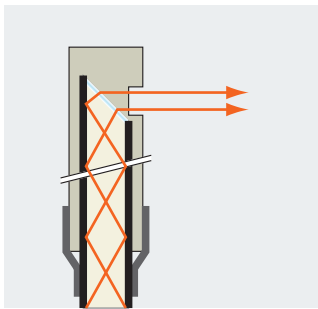

Focused and high precision beam alignment during manufacturing. Models available with typical deviation of 0.1° for very precise detections

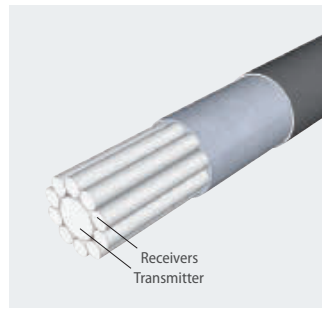

Coaxial fibers provide an enhanced positioning and detection accuracy and allow the easy adjustment of the focal point using adjustable focal lenses

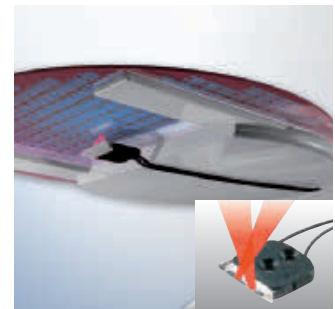
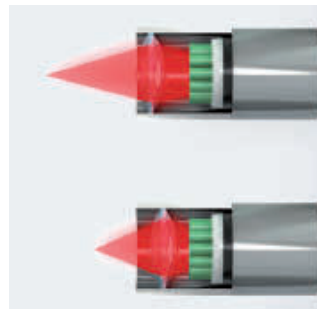

Limited reflective fibers utilize the total reflection on shiny surfaces to detect height differences or objects at a pre-defined distance.

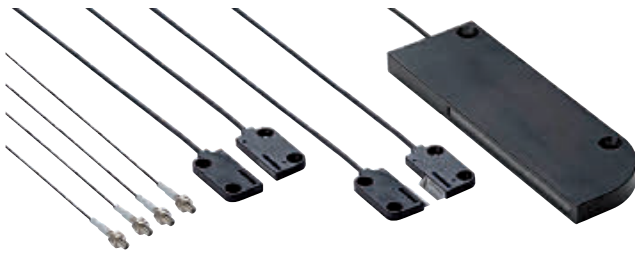

**Area monitoring fiber sensor heads**

When mounting space is crucial or the objects are very small, the area monitoring fibers provide a reliable object detection even when the object position varies within the monitored range.

In combination with the window monitoring function or the serial transmission of the received light level values of the fiber amplifiers, simple height comparison or measuring applications can be realized.

- Area monitoring up to 70 mm height
- Multi-beam sensor with 4 separate heads for flexible detection points
- Standard or high flex fibers

**Ordering information**

Sensor type	Sensing height (in mm)	Sensing distance (in mm) <sup>*1</sup>				Order code	
		Standard fiber		High-flex fiber		Standard fiber	High-flex fiber
		E3X-HD	E3NX-FA	E3X-HD	E3NX-FA		
	10	4000	4000	–	–	E32-T16	–
	11 <sup>*2</sup>	2200	3300	1700	2550	E32-T16P	E32-T16PR 2M
	30	3600	4000	2600	3900	E32-T16W 2M	E32-T16WR 2M
	50	–	–	3000	4000	–	E32-ET16WR-2 2M
	70	–	–	3500	4000	–	E32-ET16WR-1 2M
	11	2000	3000	1500	2200	E32-T16J 2M	E32-T16JR 2M
	4 x separate M3 heads	1300	1900	–	–	E32-M21	–
	11	–	–	300	450	–	E32-D36P1 2M

<sup>\*1</sup> Sensing distance measured with Standard mode

<sup>\*2</sup> Sensing area aligned to top of housing.

**Specifications**

Item	Standard			High-flex			
	E32-T16	E32-M21	E32-T16J E32-T16P E32-T16W	E32-D36P1	E32-ET16WR-1 E32-ET16WR-2	E32-T16JR E32-T16PR E32-T16WR	
Permissible bending radius	R25			R4	R1		
Cut to length	Yes						
Ambient temperature	–40°C to 70°C						
Material	Head	ABS	Stainless steel	ABS	Brass-nickel plated	Aluminium	ABS
	Fiber	PMMA					
	Sheath	Polyethylene coating		PVC coating	Polyethylene coating		PVC coating
Degree of protection	IEC 60529 IP67			IEC 60529 IP50		IEC 60529 IP54	IEC 60529 IP50

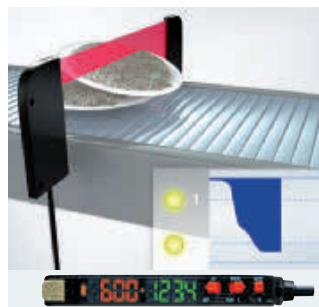
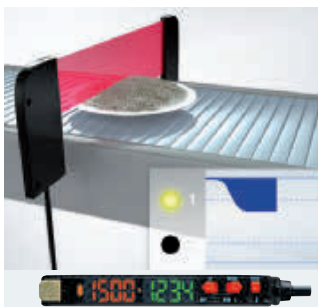

The two outputs of the E3NX-FA can be used to detect two different light levels

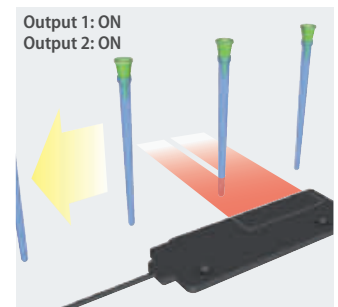
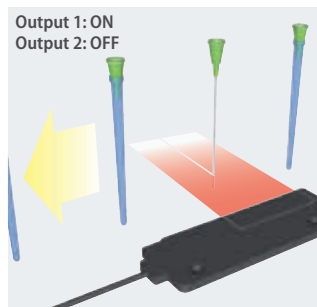

In combination with the twin output function of the E3NX-FA amplifier, the diffuse reflective area monitoring fibers can detect very small objects (e.g. needles) and a second state (e.g cover present). The area beam compensates for position variations at high speed.



**Special application fiber sensor heads**

For a wide range of special applications, the task optimised fiber heads provide best fitting sensing performance and adaption to environmental requirements.

- Detection of special objects (liquids, labels on foils, etc.)
- Fiber heads optimised for special tasks (wafer mapping, flat glass, etc.)

**Ordering information**

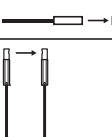
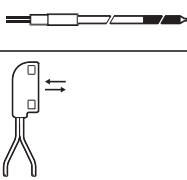
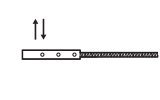
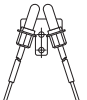
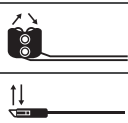
Sensor type	Size	Sensing distance (in mm) <sup>*1</sup>		Comment	Order code	
		E3X-HD	E3NX-FA			
	Fork shape 36 × 24 × 8 mm	10		–	E32-G14	
	dia 3 mm	3800	4000	–	E32-T22S	
	dia 3 mm	2600	3900	–	E32-T24S	
	dia 3 mm	1780	2650	–	E32-A03 2M	
	dia 2 mm	680	1000	–	E32-A04 2M	
	dia 6 mm	liquid contact		Liquid level contact	E32-D82F1 4M	
	15 × 23.5 × 5 mm	tube contact		Liquid level detection through transparent tube or container	E32-D36T 2M	
	Glass detection 21 × 16.5 × 4 mm	8		Metal housing	E32-A10 2M	
		20.5 × 14 × 3.8 mm		15		Plastic housing
	Glass detection in hot environment 25 × 18 × 5 mm	1–5		Heat resistant up to 300°C		E32-L64 2M
		36 × 18 × 5.5 mm		5–18		E32-L66 2M
	Glass detection in wet processes 38.5 × 39 × 17.5 mm	8 to 20 (recommended: 11)		Heat resistant up to 85°C	E32-L11FS 2M	
	Label detection 20 × 20 × 5 mm	7.2±1.8		–	E32-L25L	
	18 × 20 × 4 mm	4±2		–	E32-L24L	
	34 × 25 × 8 mm	2.4		Very precise spot (detection accuracy 100 µm)	E32-EL24-1 2M	

<sup>\*1</sup> Sensing distance measured in Standard Mode



Specifications

Item	E32-D82F1 E32-L11FS	E32-G14	E32-A10	E32-L16-N	E32-L66	E32-L64		
Permissible bending radius	R40	R25						
Cut to length	Yes					No		
Ambient temperature	-40°C to 70°C					-40°C to 300°C		
Material	Head	PFA	ABS	ABS	PVC	Stainless steel		
	Fiber	PMMA					Glass	
	Sheath	Polyethylene coating				Stainless steel spiral coating		
Degree of protection	IEC 60529 IP67			IEC 60529 IP30	IEC 60529 IP40	IEC 60529 IP40	IEC 60529 IP50	

Item	E32-EL24-1	E32-T24S	E32-L24L E32-L25L	E32-A04	E32-D36T	E32-A03	E32-T22S
Permissible bending radius	R10					R4	R1
Cut to length	Yes						
Ambient temperature	-40°C to 70°C						
Material	Head	Brass-nickel plated and aluminum	Stainless steel	Brass-nickel plated	Stainless steel	ABS	Brass-nickel plated
	Fiber	PMMA					
	Sheath	Polyethylene coating	PVC coating	Polyethylene coating		PVC coating	Polyethylene coating
Degree of protection	IEC 60529 IP67		IEC 60529 IP50		IEC 60529 IP67	IEC 60529 IP50	IEC 60529 IP67

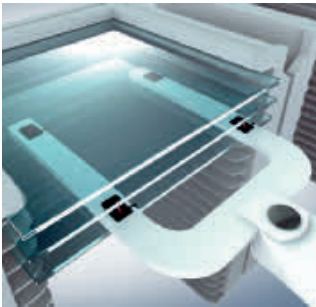

The limited reflective fiber heads for glass detection provide a stable detection of flat glass in standard, hot or wet environment. The shapes and materials are optimized to provide the best value - performance ratio depending on the requirements.



For the detection of very small height differences like labels on foils in applications where space is crucial, the small sized limited reflective sensors provide accurate detection up to 100 µm resolution.

## Accessories

Shape	Type	Comment	Order code
	Focal lens	<ul style="list-style-type: none"> <li>Extends sensing distance by more than 500%</li> <li>For M4 Through beam fibers E32-TC200, E32-ET11R, E32-T11 (fits M2.6 thread)</li> <li>2 pcs per set</li> </ul>	E39-F1
	Focal lens (side view)	<ul style="list-style-type: none"> <li>For M4 through beam fibers E32-TC200, E32-ET11R, E32-T11, E32-T61-S, E32-T81R-S (fits M2.6 thread)</li> <li>Temperature range -40 to 200°C</li> <li>2 pcs per set</li> </ul>	E39-F2
	Focal lens (variable)	<ul style="list-style-type: none"> <li>For precision detection with E32-D32, E32-EC41</li> </ul>	E39-F3A
	Focal lens	<ul style="list-style-type: none"> <li>For precision detection with E32-EC41</li> </ul>	E39-F3A-5
		<ul style="list-style-type: none"> <li>For precision detection with E32-EC41</li> </ul>	E39-F3B
		<ul style="list-style-type: none"> <li>For precision detection with M6 coaxial diffuse reflective fibers (e.g. E32-CC200)</li> </ul>	E39-F18
	Focal lens (side view, variable)	<ul style="list-style-type: none"> <li>For precision detection with E32-EC31</li> </ul>	E39-EF51
	Focal lens (heat resistant)	<ul style="list-style-type: none"> <li>Extends sensing distance by more than 500%</li> <li>For M4 through beam fibers E32-ET51, E32-T61, E32-T61-S, E32-T81R, E32-T81R-S (fits M4 thread)</li> <li>Temperature range -60 to 350°C</li> <li>2 pcs per set</li> </ul>	E39-EF1-37-2
		<ul style="list-style-type: none"> <li>For M4 through beam fibers E32-ET51, E32-T61, E32-T61-S, E32-T81R, E32-T81R-S (fits M4 thread)</li> <li>Temperature range -60 to 350°C</li> <li>2 pcs per set</li> </ul>	E39-F16
	Focal lens (vacuum resistant, heat resistant)	<ul style="list-style-type: none"> <li>Fits E32-T51V and E32-T54V (fits M2.6 thread)</li> <li>2 units per set</li> <li>Heat resistant up to 120°C</li> </ul>	E39-F1V
	Fiber cutter	<ul style="list-style-type: none"> <li>Included in applicable fiber</li> </ul>	E39-F4
	Thin fiber attachment	<ul style="list-style-type: none"> <li>Amplifier adapter for thin fibers</li> <li>Included in applicable fiber (2 sets)</li> </ul>	E39-F9
	Sleeve bender	<ul style="list-style-type: none"> <li>For E32-TC200B(4)</li> <li>For E32-TC200F(4)</li> <li>For E32-DC200F(4)</li> </ul>	E39-F11
	Single fiber extension connector	<ul style="list-style-type: none"> <li>Fiber extension connector for 2.2 mm dia standard fibers</li> <li>One unit</li> </ul>	E39-F10
	Dual fiber extension connector	<ul style="list-style-type: none"> <li>For fibers with dia 2.2</li> </ul>	E39-F13
		<ul style="list-style-type: none"> <li>For fiber with dia 1.0</li> </ul>	E39-F14
		<ul style="list-style-type: none"> <li>For fibers with dia between 1.0 and 2.2</li> </ul>	E39-F15
	Protective spiral tube <sup>*1</sup>	<ul style="list-style-type: none"> <li>For M3 diffuse type sensors</li> <li>Length 1 m</li> </ul>	E39-F32A
		<ul style="list-style-type: none"> <li>For M3 through beam type sensors</li> <li>Length 1 m</li> </ul>	E39-F32B
		<ul style="list-style-type: none"> <li>For M4 through beam type sensors</li> <li>Length 1 m</li> </ul>	E39-F32C
		<ul style="list-style-type: none"> <li>For M6 diffuse type sensors</li> <li>Length 1 m</li> </ul>	E39-F32D
	Fiber on roll <sup>*2</sup>	<ul style="list-style-type: none"> <li>Dia 2.2 mm</li> <li>Standard monocoire, 10 mm bending radius</li> <li>-40 to 80°C</li> </ul>	E32-E01 100M
		<ul style="list-style-type: none"> <li>Dia 1.1 mm</li> <li>Standard monocoire, 15 mm bending radius</li> <li>-40 to 80°C</li> </ul>	E32-E02 100M
		<ul style="list-style-type: none"> <li>Dia 2.2 mm</li> <li>High flex multicore, 1 mm bending radius</li> <li>-40 to 80°C</li> </ul>	E32-E01R 100M
		<ul style="list-style-type: none"> <li>Dia 1.1 mm</li> <li>High flex multicore, 1 mm bending radius</li> <li>-40 to 80°C</li> </ul>	E32-E02R 100M
		<ul style="list-style-type: none"> <li>Dia 2.2 mm</li> <li>High temperature monocoire, 20 mm bending radius</li> <li>-60 to 150°C</li> </ul>	E32-E05 100M
		<ul style="list-style-type: none"> <li>Dia 2.2 mm</li> <li>High temperature monocoire, 20 mm bending radius</li> <li>-60 to 150°C</li> </ul>	E32-E05 100M

<sup>\*1</sup> Protective spiral tubes with 0.5 m length are available. Add '5' to order code ... e.g. E39-F32A5

<sup>\*2</sup> Fiber length 100 m on a roll – cut to length



### Easy-teach digital fiber amplifier

The E3X-HD with 1-button Smart tune set-up provides fast and simple teaching. Dual digital display and advanced features make the E3X-HD ideal even for demanding applications.

- Easy teaching by Smart tuning within a few seconds
- Dynamic Power Control (DPC) for highest operational stability for changing environmental conditions or challenging objects
- M8 connector models
- EtherCAT and CompoNet Communication units for high-speed field bus connectivity

### Ordering information

Item	Order code		
	Transistor output models		Communication unit model <sup>*1</sup>
	NPN output	PNP output	
Pre-wired	E3X-HD11 2M	E3X-HD41 2M	–
Fiber amplifier connector	E3X-HD6	E3X-HD8	E3X-HD0
M8 connector (4pin)	E3X-HD14	E3X-HD44	–

<sup>\*1</sup> For field bus connection please chose Communication unit E3X-ECT for EtherCAT or E3X-CRT for CompoNet.

### Fiber amplifier connectors

Shape	Type	Comment	Order code
	Fiber amplifier connector	2 m PVC cable	E3X-CN11
		30 cm PVC cable with M12 plug connector (4 pin)	E3X-CN21-M1J 0.3M
		30 cm PVC cable with M8 plug connector (4 pin)	E3X-CN21-M3J-2 0.3M

### Communication units

Shape	Communications method	Applicable Fiber Amplifier Units	Order code
	CompoNet	E3X-HD0 E3X-MDA0 E3X-DA0-S	E3X-CRT
	EtherCAT		E3X-ECT

## Specifications

Item	Type	Standard models						For Communications Unit	
	Model	E3X-HD11	E3X-HD41	E3X-HD6	E3X-HD8	E3X-HD14	E3X-HD44	E3X-HD0	
	Connection method	Pre-wired			Wire-saving connector		M8-4pin connector		Communications unit connector
	Control output	NPN output	PNP output	NPN output	PNP output	NPN output	PNP output	-	
Light source (wavelength)		Red, 4-element LED (625 nm)							
Power supply voltage		12 to 24 VDC±10%, ripple (p-p) 10% max.							
Power consumption		Normal Mode: 720 mW max. (Current consumption: 30 mA max. at 24 VDC, 60 mA max. at 12 VDC.) Power Saving Eco Mode: 530 mW max. (Current consumption: 22 mA max. at 24 VDC, 44 mA max. at 12 VDC.)							
Control output		Load power supply voltage: 26.4 VDC max., open-collector output (Varies with the model depending on output is PNP or NPN.)Load current: 50 mA max. (residual voltage: 2 V max.), OFF current: 0.5 mA max.						-	
Response time	Super-high-speed Mode (SHS)	Operate or reset: 50 µs (NPN models) or 55 µs (PNP models)							
	High-speed Mode (HS)	Operate or reset: 250 µs							
	Standard Mode (STND)	Operate or reset: 1 ms							
	Giga-power Mode (GIGA)	Operate or reset: 1 ms							
Mutual interference prevention		Possible for up to 10 units							
Maximum connectable Units		16 units						with E3X-CRT: 16 units with E3X-ECT: 30 units	

Easy One-Button-Teaching/Smart Tuning

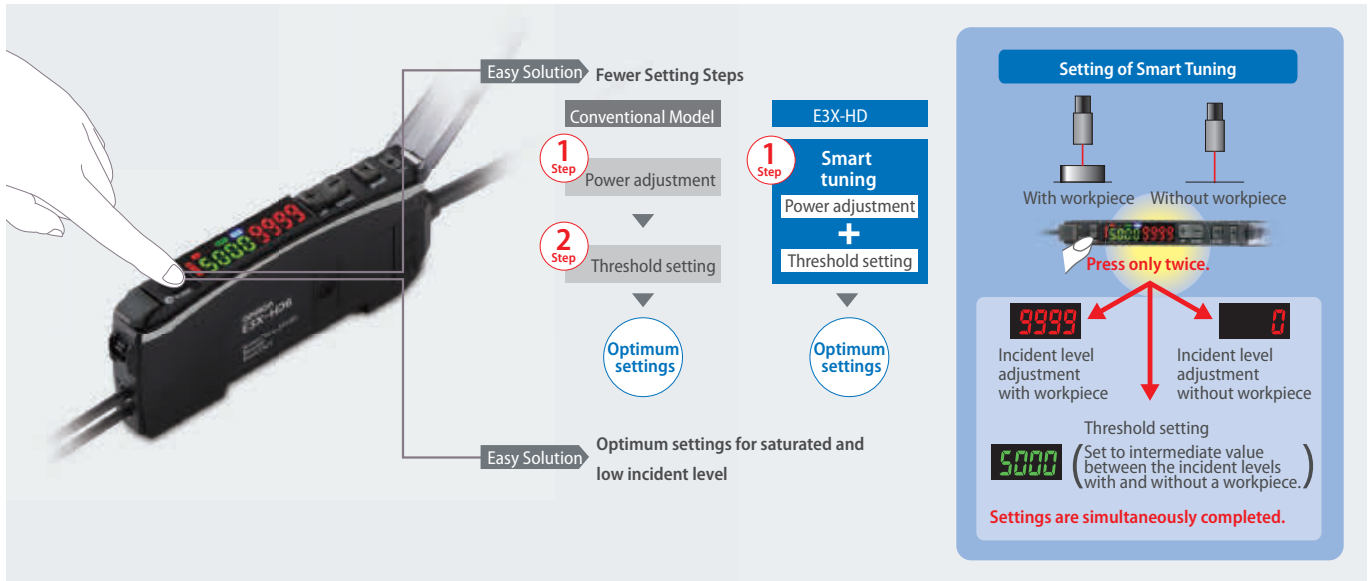

Easy setting of optimum power and threshold by pushing tune button twice.

Smart power control

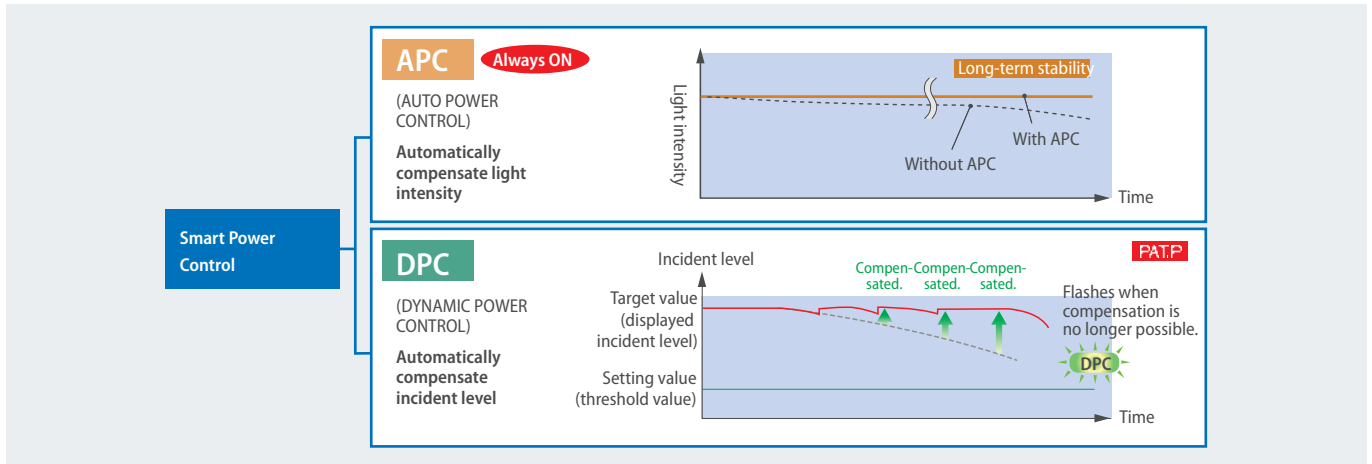

Enhanced signal stability control for compensating power reductions caused by temperature drift, dust or aging of LED.

Field bus connectivity



Field bus communication allows control by an external device to simplify setup and reduce wiring effort.





### Single display digital fiber amplifier

E3X-SD allows easy one button setting and provide the best value performance ratio for standard applications.

- Auto-teaching during machine operation
- 2-point teaching within a few seconds
- Simple threshold adjustment with up/down keys

### Ordering information

Item	Order code	
	NPN output	PNP output
Pre-wired	E3X-SD21 2M	E3X-SD51 2M
Fiber amplifier connector*1	E3X-SD7	E3X-SD9

\*1 Order connector separately. For M8 connector models see E3X-HD.

### Fiber amplifier connectors

Shape	Type	Comment	Order code
	Fiber amplifier connector	2 m PVC cable	E3X-CN11
		30 cm PVC cable with M12 plug connector (4 pin)	E3X-CN21-M1J 0.3M
		30 cm PVC cable with M8 plug connector (4 pin)	E3X-CN21-M3J-2 0.3M

### Specifications

Item	E3X-SD	
Light source (wave length)	Red, 4-element LED (625 nm)	
Power supply voltage	12 to 24 VDC ±10%, ripple (p-p): 10% max.	
Protective circuits	Power supply reverse polarity protection, output short-circuit protection, mutual interference prevention	
Response time	Operation or reset: 200 μs max	
Sensitivity setting	Teaching and digital up/down keys	
Functions	Auto power control	High-speed control method for emission current
	Mutual interference prevention	Optical communication sync. possible for up to 5 units
Digital displays	Incident level or threshold	
Degree of protection	IEC 60529 IP50 (with protective cover attached)	

### Easy operation by ergonomic buttons



#### Auto-teaching

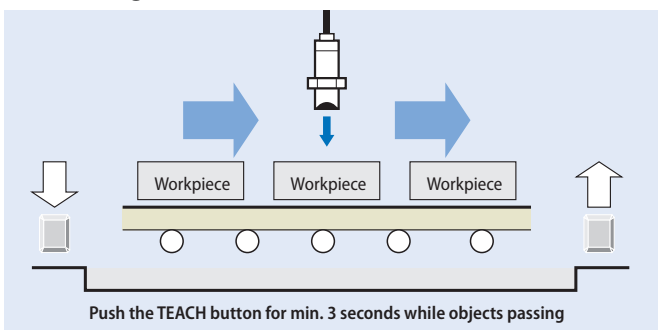

#### 2-point teaching

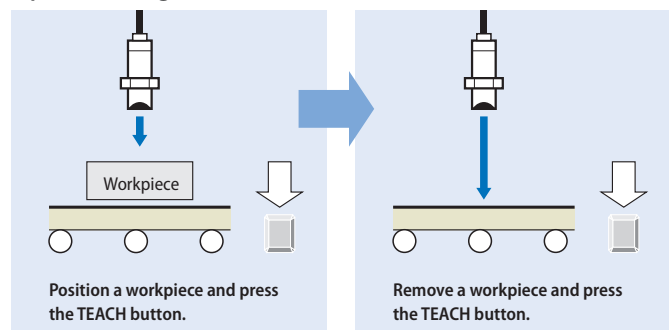

Digital fiber amplifier with potentiometer adjustment

The E3X-NA is the ideal amplifier for standard fiber applications providing quick & easy potentiometer adjustment and bargraph display.

- Easy adjustment with potentiometer
- Mutual interference prevention
- Enhanced water resistance types



Ordering information

Pre-wired

Item	Order code (for pre-wired types with 2 m cable length)	
	NPN output	PNP output
Standard	E3X-NA11 2M	E3X-NA41 2M
Enhanced water resistance	E3X-NA11V 2M	E3X-NA41V 2M

Connector version

Item	Order code	
	NPN output	PNP output
Standard (fiber amplifier connector)*1	E3X-NA6	E3X-NA8
Enhanced water resistance (M8 4-pin connector)	E3X-NA14V	E3X-NA44V

\*1 Order connector separately.

Fiber amplifier connectors

Shape	Type	Comment	Order code
	Fiber amplifier connector	2 m PVC cable	E3X-CN21
		30 cm PVC cable with M12 plug connector (4 pin)	E3X-CN21-M1J 0.3M
		30 cm PVC cable with M8 plug connector (4 pin)	E3X-CN21-M3J-2 0.3M

Specifications

Item	Standard		Enhanced water resistance
	Output	NPN output	E3X-NA11, E3X-NA6
	PNP output	E3X-NA41, E3X-NA8	E3X-NA41V, E3X-NA44V
Light source (wave length)	Red LED (625 nm)		
Power supply voltage	12 to 24 VDC±10%, ripple (p-p): 10% max.		
Protective circuit	Reverse polarity protection, output short-circuit protection, mutual interference prevention		
Response time	Operation or reset: 200 μs max.		
Sensitivity setting	8-turn endless adjuster (potentiometer)		
Functions	OFF-delay timer: 40 ms (fixed)		
Degree of protection	IEC 60529 IP50 (with protective cover attached)		IEC 60529 IP66 (with protective cover attached)

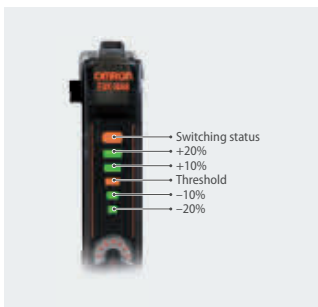

Bargraph display with light level, switching status and threshold indicators

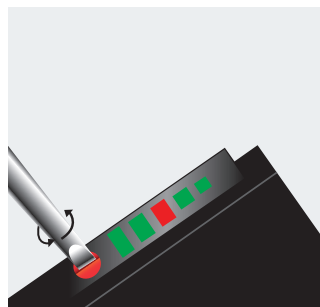

Simple sensitivity adjustment by potentiometer



### High-performance digital fiber amplifier

The E3NX-FA amplifier is best choice for most challenging fiber applications in terms of long sensing distance, minute object detection or high speed processes.



- Easy teaching by Smart tuning within a few seconds
- New N-Smart technology provides significant improvement for sensing distance, minimum object detection and speed
- Easy and transparent information about sensor status by Solution Viewer and Change Finder function
- EtherCAT Communication unit for high-speed field bus connectivity

### Ordering information



Item	Connection	Inputs/Outputs	Order code	
			NPN output	PNP output
Standard models	Pre-wired	1 output	E3NX-FA11 2M	E3NX-FA41 2M
	Fiber amplifier connector		E3NX-FA6	E3NX-FA8
Advanced models	Pre-wired	2 outputs + 1 input	E3NX-FA21 2M	E3NX-FA51 2M
	Fiber amplifier connector	1 output + 1 input	E3NX-FA7	E3NX-FA9
		2 outputs	E3NX-FA7TW	E3NX-FA9TW
	M8 connector	1 output + 1 input	E3NX-FA24	E3NX-FA54
		2 output	–	E3NX-FA54TW
Networking model*1	Connector for communication unit	via com. protocol	E3NX-FA0	

\*1 For field bus connection please chose communication unit E3NW-ECT for EtherCAT.

### Fiber amplifier connectors

Shape	Type	Comment	Order code
	Fiber amplifier connector	2 m PVC cable (4 pin)	E3X-CN21
		30 cm PVC cable with M12 plug connector (4 pin)	E3X-CN21-M1J 0.3M
		30 cm PVC cable with M8 plug connector (4 pin)	E3X-CN21-M3J-2 0.3M

### Communication units

Shape	Communications method	Applicable Amplifier Units	Order code
	Sensor communication unit for EtherCAT	E3NX-FA0 E3NC-LA0 E3NC-SA0	E3NW-ECT
	Sensor dispersion (slave) unit		E3NW-DS

## Specifications

Item	Type	Standard models		Advanced models					Model for sensor communications unit
	NPN output	E3NX-FA11	E3NX-FA6	E3NX-FA21	E3NX-FA7	E3NX-FA7TW	E3NX-FA24	–	E3NX-FA0
	PNP output	E3NX-FA41	E3NX-FA8	E3NX-FA51	E3NX-FA9	E3NX-FA9TW	E3NX-FA54	E3NX-FA54TW	
	Connection method	Pre-wired	Wire-saving connector	Pre-wired	Wire-saving connector		M8 connector		Connector for sensor communications unit
Inputs/outputs	Outputs	1 output		2 outputs	1 output	2 outputs	1 output	2 outputs	via com. protocol
	External inputs	–		1 input	1 input	–	1 input	–	–
Light source (wavelength)		Red, 4-element LED (625 nm)							
Power supply voltage		10 to 30 VDC, including 10% ripple (p-p)							
Power consumption		At power supply voltage of 24 VDC Standard model or model for sensor communications unit: Normal mode: 960 mW max. (current consumption: 40 mA max.), Power saving eco mode: 840 mW max. (current consumption: 35 mA max.) Advanced model: Normal mode: 1,080 mW max. (current consumption: 45 mA max.), Power saving eco mode: 930 mW max. (current consumption: 40 mA max.)							
Control output		Load power supply voltage: 30 VDC max., open-collector output Load current: groups of 1 to 3 amplifiers: 100 mA max., groups of 4 to 30 amplifiers: 20 mA max. Residual voltage: at load current of less than 10 mA: 1 V max. at load current of 10 to 100 mA: 2 V max. OFF current: 0.1 mA max.							–
Response time	Super-high-speed Mode (SHS) <sup>*1</sup>	Operate or reset for model with 1 output: 30 μs, with 2 outputs: 32 μs							
	High-speed Mode (HS)	Operate or reset: 250 μs							
	Standard Mode (Std)	Operate or reset: 1 ms							
	Giga-power Mode (GIGA)	Operate or reset: 16 ms							
No. of units for mutual interference prevention	Super-high-speed Mode (SHS) <sup>*1</sup>	0							
	High-speed Mode (HS)	10							
	Standard Mode (Std)	10							
	Giga-power Mode (GIGA)	10							
Functions		Auto power control (APC), dynamic power control (DPC), timer, zero reset, resetting settings, eco mode, bank switching, power tuning, and hysteresis width							
Maximum connectable units		30							

<sup>\*1</sup> The mutual interference prevention function is disabled if the detection mode is set to super-high-speed mode.

Easy One-Button-Teaching/Smart Tuning



Automatic setting of optimum values

Threshold + Incident level

**5000** **9999**

Set to the intermediate value between the incident levels with and without a workpiece.

Incident level adjustment with and without a workpiece

Dynamic range increased by a factor of 40,000

Easy setting of optimum power and threshold by pushing tune button twice.

Smart power control

Smart Power Control

APC

Always ON

(AUTO POWER CONTROL)

Automatically compensate light intensity

DPC

PAT.P

(DYNAMIC POWER CONTROL)

Automatically compensate incident level

Enhanced signal stability control for compensating power reductions caused by temperature drift, dust or aging of LED. Alarm output added for predictive maintenance.

N-Smart platform



The N-Smart platform provides wide portfolio of advanced sensors – all with the same intuitive operation concept and field bus connectivity.

2-in-1 Digital fiber amplifier

E3X-MDA incorporates 2 digital fiber amplifiers in one slimline housing. For applications requiring the detection of two objects simultaneously the E3X-MDA provides an easy to use operation saving space and set-up time.

- Two digital amplifiers in one slimline housing
- Twin output models – on/off or area (between two threshold values)
- Signal comparison functions (AND, OR, etc.)



Ordering information

Item	Functions	Order code	
		NPN output	PNP output
Pre-wired	AND/OR output	E3X-MDA11	E3X-MDA41
Fiber amplifier connector*1	AND/OR output	E3X-MDA6	E3X-MDA8

\*1 Order connector separately.

Fiber amplifier connectors

Shape	Type	Comment	Order code
	Fiber amplifier connector	2 m PVC cable	E3X-CN21
		30 cm PVC cable with M12 plug connector (4 pin)	E3X-CN21-M1J 0.3M
		30 cm PVC cable with M8 plug connector (4 pin)	E3X-CN21-M3J-2 0.3M

Specifications

Item	E3X-MDA	
Light source (wave length)	Red LED (650 nm)	
Power supply voltage	12 to 24 VDC±10%, ripple (p-p) 10% max.	
Protective circuits	Power supply reverse polarity protection, output short-circuit protection, mutual interference prevention	
Response time	Super-high-speed mode	130 μs for operation and reset respectively
	Standard mode	1 ms for operation and reset respectively
	High-resolution mode	4 ms for operation and reset respectively
Sensitivity setting	Teaching and digital up/down keys	
Functions	Power tuning	Light emission power and reception gain, digital control method
	Timer function	Select from OFF-delay, ON-delay, or one-shot timer. 1 ms to 5 s (1 to 20 ms set in 1-ms increments, 20 to 200 ms set in 10-ms increments, 200 ms to 1 s set in 100-ms increments, and 1 to 5 s set in 1 s-increments)
	I/O settings	Output setting (select from channel 2 output, AND, OR, leading edge sync, falling edge sync, or differential output)
Digital displays	Select from the following: Incident level for channel 1 + incident level for channel 2, Incident level + threshold, incident level percentage + threshold, incident light peak level + no incident light bottom level, minimum incident light peak level + maximum no incident light bottom level, long bar display, incident level + peak hold, incident level + channel	
Degree of protection	IEC 60529 IP50 (with protective cover attached)	

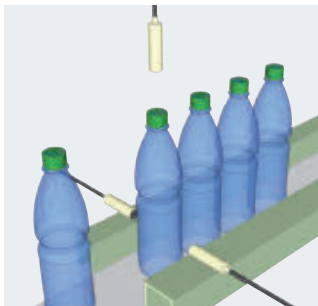

The AND and OR functionality for the two fiber channels allows simple signal processing without the need for a PLC. This allows the addition of sensor checks to machines without reprogramming the PLC.



The 2 in 1 amplifier replaces two standard amplifiers reducing space requirements and hardware cost.



### Fast response digital amplifier with potentiometer

The E3X-NA\_F provides a very fast response time and is the ideal amplifier for high speed detection applications.

- Short turn on time of only 20  $\mu$ s
- Easy adjustment with potentiometer



### Ordering information

Item	Order code	
	NPN output	PNP output
Pre-wired	E3X-NA11F	E3X-NA41F
M8 connector (4 pin)	- <sup>*1</sup>	E3X-NA44FV

<sup>\*1</sup> Contact your OMRON representative

### Specifications

Item	NPN output	E3X-NA11F	-
	PNP output	E3X-NA41F	E3X-NA44FV
Light source (wave length)	Red LED (680 nm)		
Power supply voltage	12 to 24 VDC $\pm$ 10%, ripple (p-p): 10% max.		
Protective circuit	Reverse polarity protection, output short-circuit protection, mutual interference prevention		
Response time	Operation: 20 $\mu$ s max. Reset: 30 $\mu$ s max.		
Sensitivity adjustment	8-turn endless adjuster (potentiometer)		
Functions	OFF-delay timer: 40 ms (fixed)		
Degree of protection	IEC 60529 IP50 (with protective cover attached)		IEC 60529 IP66 (with protective cover attached)

Note: For teachable fast response fiber amplifiers with a digital display contact your OMRON representative.



### E3X-DAC-S high functionality mark detection sensor

The E3X-DAC-S provides reliable mark detection for standard as well as challenging applications. The separate sensing head setup allows the easy adaption to the mounting requirements even when space is crucial. The remote amplifier provides easy teaching for standard applications but also on demand full control over the detection performance for most challenging applications.

## Ordering information

### Pre-wired

Item	Functions	Order code (for pre-wired types with 2 m cable length)	
		NPN output	PNP output
Standard models	Timer, response speed change	E3X-DAC11-S	E3X-DAC41-S
Advanced models	Same as standard models + simultaneous determination (2 colors) AND/OR output, remote setting	E3X-DAC21-S	E3X-DAC51-S

### Connector versions



Item	Functions	Order code	
		NPN output	PNP output
Standard models (fiber amplifier connector)*1	Timer, response speed change	E3X-DAC6-S	E3X-DAC8-S

\*1 Order connector separately



## Specifications

Item	Standard models		Advanced models	
	E3X-DAC1, E3X-DAC4 E3X-DAC6, E3X-DAC8		E3X-DAC2, E3X-DAC5	
Light source (wave length)	White LED (420 to 700 nm)			
Number of registered marks	1		2 (simultaneous determination)	
Power supply voltage	12 to 24 VDC±10%, ripple (p-p) 10% max.			
Protective circuits	Power supply reverse polarity protection, output short circuit protection, output reverse polarity protection, mutual interference prevention			
Ambient temperature	Operating	-25 to 55°C		
	Storage	-30 to 70°C (with no icing or condensation)		
Response time	Super-high-speed mode	Operation or reset: 60 µs		Operation or reset: 120 µs
	Standard mode	Operation or reset: 1 ms		Operation or reset: 2 ms
Sensitivity setting	Teaching (one-point teaching or teaching with/without workpiece) or manual adjustment			
Functions	Detection mode	Automode (automatic selection of C-mode or I-mode) C-mode (RGB ratio) I-mode (light intensity) Mark mode (Intensity and ratio of RGB values)		
	Operating mode	ON for match (ON for same color as registered color) or ON for mismatch (ON for different color from registered color)		
	Timer function	Timer type: OFF delay, ON delay, or one-short Timer time: 1 ms to 5 s (variable)		
	Control outputs	-		Output for each channel, AND output, and OR output
	Remote control	-		One-point teaching, teaching with/without workpiece, zero reset, and light emission OFF
Degree of protection	IEC60529 IP50 (with protective cover attached)			

### Recommended fiber heads

Sensor type	Size	Recommended operating distance (mm)	Comment	Order code
	M6	5	Standard mark detection	E32-CC200 2M
	29x25.5x11.2 mm	40 to 50	Long distance – plastic	E32-L15 2M
	23x20x9 mm	25 to 30	Long distance – metal	E32-A09 2M
	M3	10	High precision mark detection (dia 1mm spot)	E32-EC31 2M + E39-EF51

Fiber amplifier connectors

Shape	Type	Comment	Order code
	Fiber amplifier connector	2 m PVC cable	E3X-CN21
		30 cm PVC cable with M12 plug connector (4 pin)	E3X-CN21-M1J 0.3M
		30 cm PVC cable with M8 plug connector (4 pin)	E3X-CN21-M3J-2 0.3M



Easy to operate detection of challenging or colored registration marks.



Detection of challenging registration marks e.g. with texts or graphics.

### Digital fiber amplifier with infrared LED

The digital fiber amplifiers with infrared LED are ideal for water detection applications or where visible light is not desired.

- Infrared LED
- LED power control and signal processing function



### Ordering information

#### Pre-wired



Item	Order code (for pre-wired types with 2 m cable length)	
	NPN output	PNP output
Infrared light	E3X-DAH11-S 2M	E3X-DAH41-S 2M

#### Connector version

Item	Order code	
	NPN output	PNP output
Infrared light (fiber amplifier connector) <sup>*1</sup>	E3X-DAH6-S	E3X-DAH8-S

<sup>\*1</sup> Order connector separately

#### Fiber amplifier connectors

Shape	Type	Comment	Order code
	Fiber amplifier connector	2 m PVC cable	E3X-CN21
		30 cm PVC cable with M12 plug connector (4 pin)	E3X-CN21-M1J 0.3M
		30 cm PVC cable with M8 plug connector (4 pin)	E3X-CN21-M3J-2 0.3M

### Specifications

#### Amplifier units with cables

Item	NPN output	E3X-DAH11-S, E3X-DAH6-S	
	PNP output	E3X-DAH41-S, E3X-DAH8-S	
Light source (wave length)	Infrared LED		
Power supply voltage	12 to 24 VDC±10%, ripple (p-p) 10% max.		
Protective circuits	Power supply reverse polarity protection, output short circuit protection, mutual interference prevention		
Response time	Super-high-speed mode	NPN	48 μs for operation and 50 μs for reset
		PNP	53 μs for operation and 55 μs for reset
	Standard mode	1 ms for operation and reset respectively	
	High-resolution mode	4 ms for operation and reset respectively	
Sensitivity setting	Teaching and digital up/down keys		
Functions	Power tuning	Light emission power and reception gain, digital control method	
	Timer function	Select from OFF-delay, ON-delay, or one-shot timer. 1 ms to 5 s (1 to 20 ms set in 1-ms increments, 20 to 200 ms set in 10-ms increments, 200 ms to 1 s set in 100-ms increments, and 1 to 5 s set in 1 s-increments)	
Digital displays	Incident level + threshold or user specific		
Degree of protection	IEC 60529 IP50 (with protective cover attached)		

Fiber optics

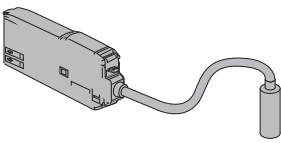
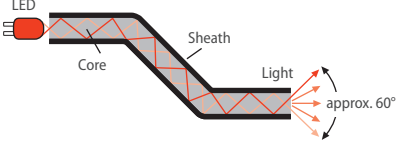
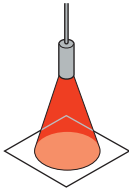
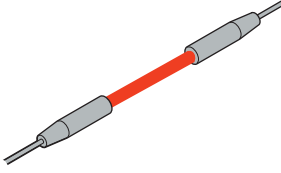
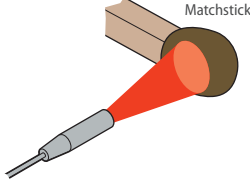
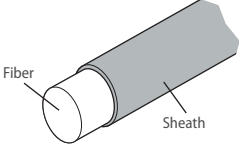
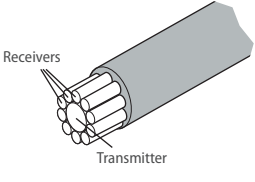
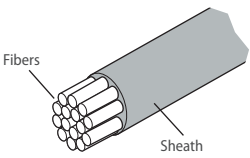
Item		
Principle of operation		Fiber optic photoelectric sensors comprise two parts, the amplifier and the sensing head. The amplifier contains the emitter (the light source) and receiver (detector) along with their associated electronics. The fiber optic cable is the means used to transfer the light to the sensing head.
		The light source (an LED) transmits the light beam down the fiber optic cable by repeatedly reflecting the light off the boundary between the fiber core and its sheath. When it reaches the end of the fiber the light is dispersed at the end.
		When the light is dispersed it spreads out and forms a beam much like that of other sensors, but on a smaller scale. With smaller light sources and lens areas the sensing ranges are on the whole much shorter.
Types of fiber		Fiber optic heads mainly split into two types, through-beam and diffuse (although there are a few retro-reflective types). The principle of operation of both types is exactly that of standard photoelectric sensors.
		
Construction		Standard fiber: Most fiber optic sensing heads use this configuration of fiber (i.e. a single fiber covered by a protective sheath). The fibers are usually plastic, 0.5 to 1 mm in diameter and covered in a plastic protective sheath.
		Coaxial fiber: This gives greater accuracy. The core is used as the transmitter and the surrounding fibers are bundled together to form the receiver. This gives better accuracy, the target can enter the detecting area from any direction.
		Multicore: These consist of large numbers of small fibers. This results in a more flexible cable (E32-R types) which can literally be tied in a knot. Robotic: In robotic fibers the multicore fibers are manufactured without fixation. This allows them to move freely reducing mechanical stress when the fiber is bent.

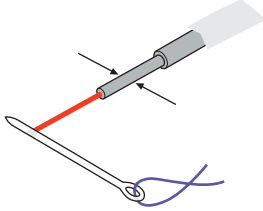
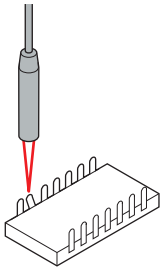
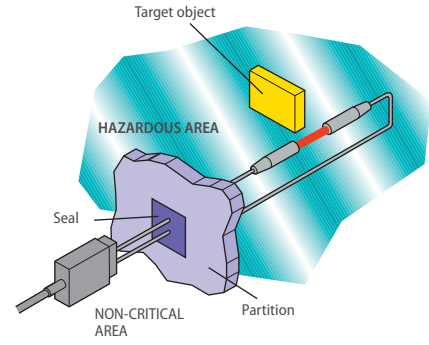
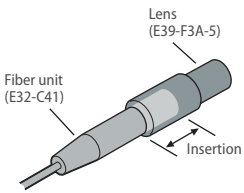
Item		
Using fiber optic sensors		<p>The main advantage of fiber optics is that they are small. This means that they can be mounted in places where other sensors couldn't fit.</p>
		<p>As the sensor heads are extremely compact, they are ideal for the stable detection of small objects. As a result of the less light that is emitted they generally do have smaller ranges than conventional photoelectric sensors.</p>
		<p>Fiber optic sensor heads can be used in areas that standard sensors are unable to go, for instance hazardous areas. This is because no electric current flows through them. This also means they are totally unaffected by electrical noise (provided the amplifier is suitably positioned). By using glass fibers instead of plastic they can be used in areas of up to 350°C.</p>
		<p>Extremely small objects can be detected with a diffuse coaxial sensor and additional focal lens. Using these, objects as small as 100 μm can be detected.</p>





# Dimensions

## E32-C42

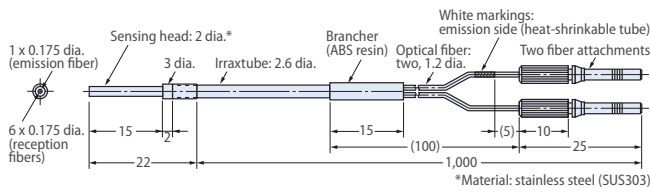

## E32-CC200

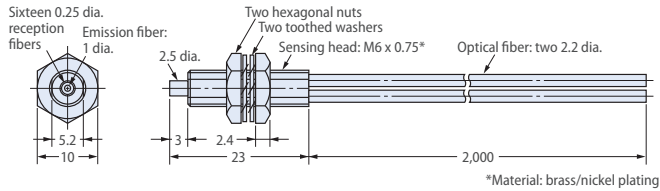

## E32-D11, E32-D11U

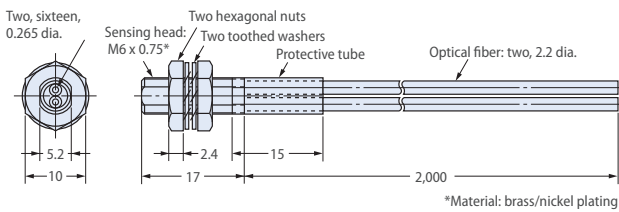

## E32-D11N

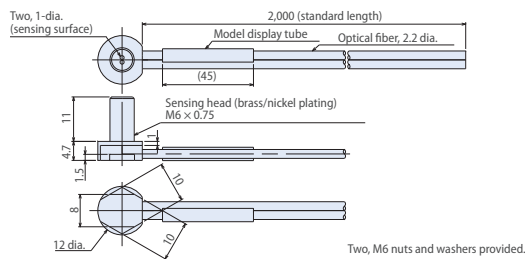

## E32-D11R

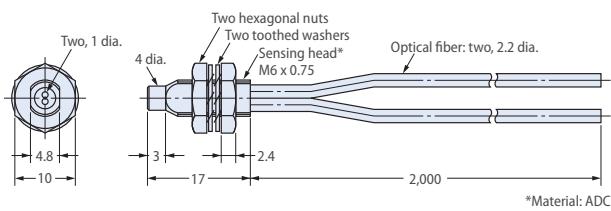

## E32-D12

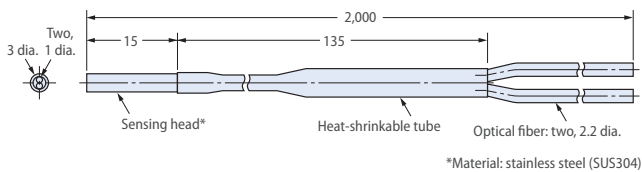

## E32-D12F

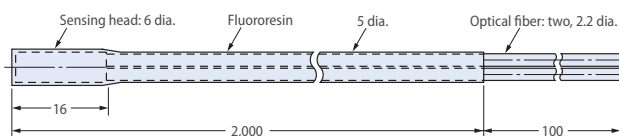

## E32-D14F

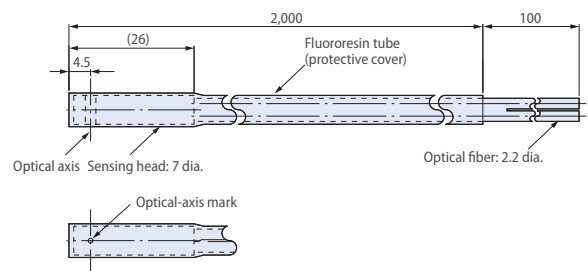

## E32-D14L, E32-D14LR

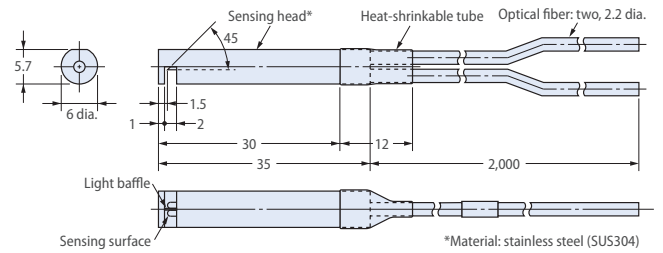

## E32-D15X, E32-D15XB, E32-D15XR

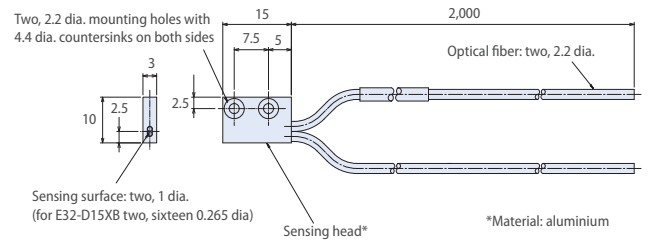

## E32-D15Y, E32-D15YR

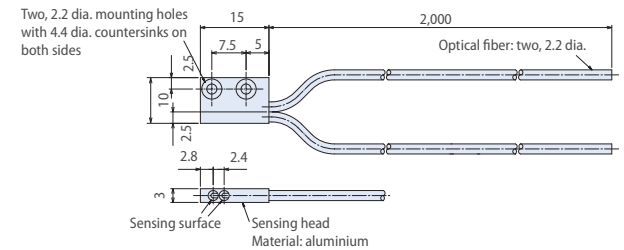

## E32-D15Z

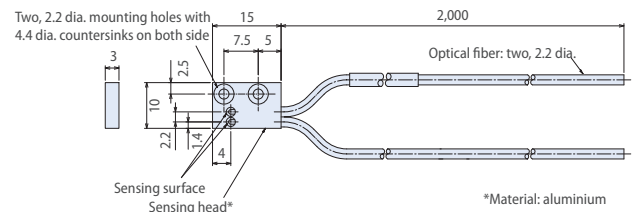

## E32-D16

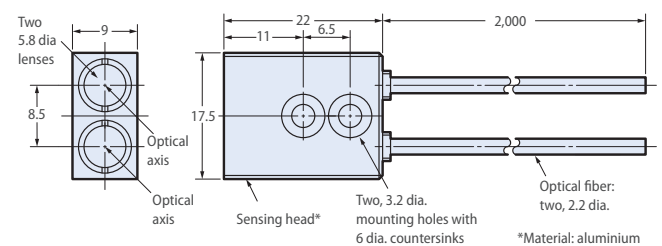

# Dimensions

## E32-D21

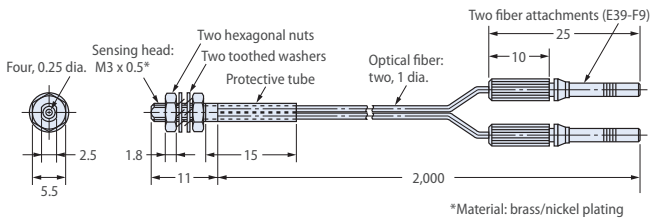

## E32-D21N

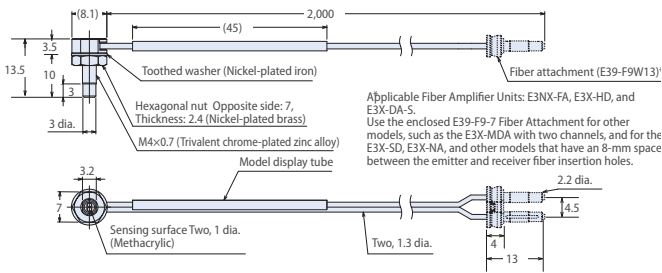

## E32-D21B

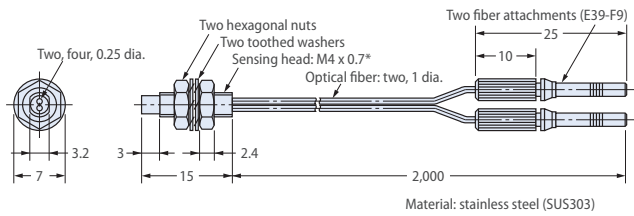

## E32-D21L

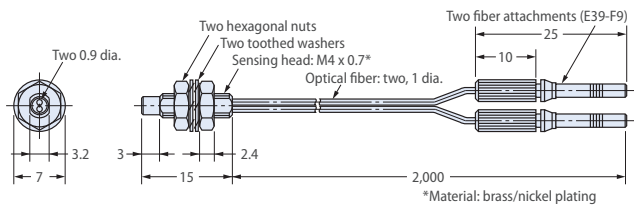

## E32-D21R

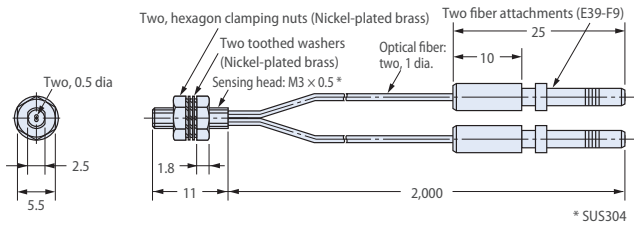

## E32-D22, E32-D22R

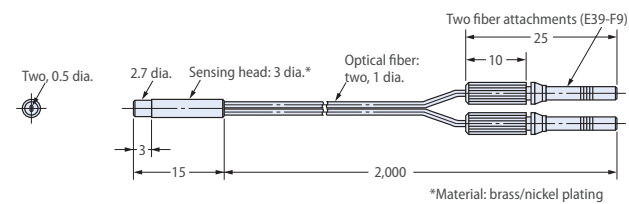

## E32-D22B

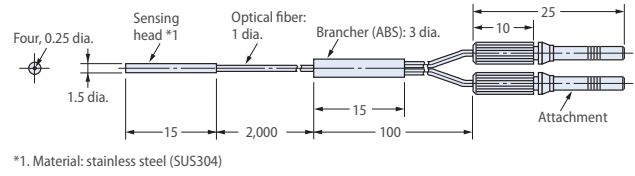

## E32-D24, E32-D24R

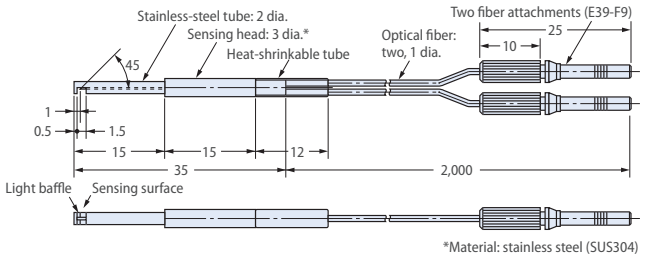

## E32-D32 / E32-D32R

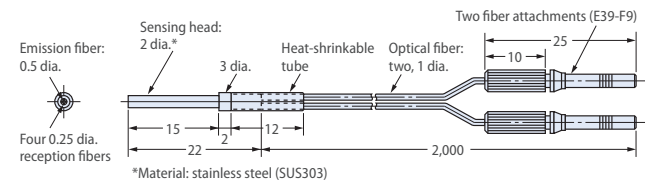

## E32-D32L

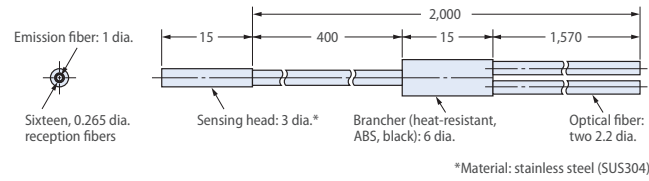

## E32-D33

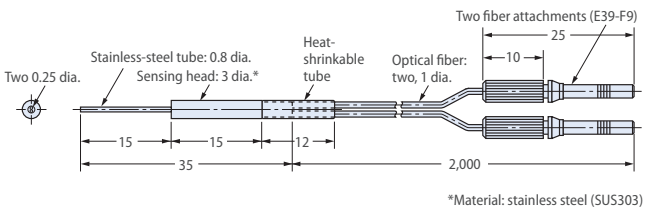

## E32-D36P1

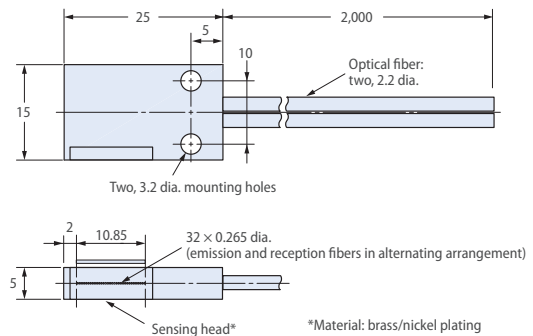

# Dimensions

## E32-D36T

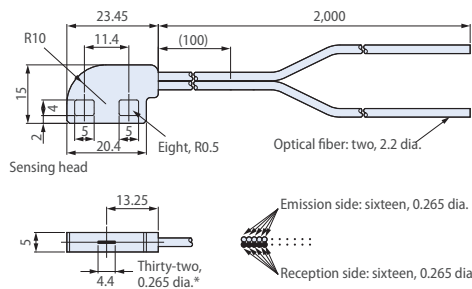

## E32-D81R-S, E32-D81R

### Using the E32-D81R-S

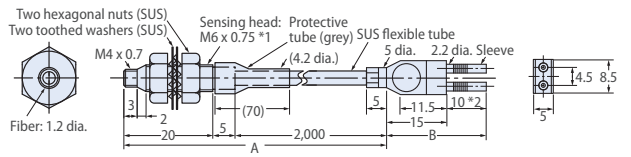

### Using the E32-D81R

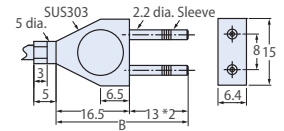

\*1. Material: stainless steel (SUS303)

## E32-D51

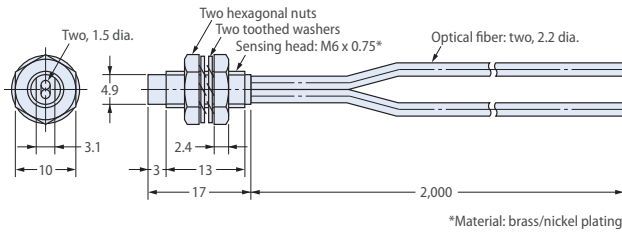

## E32-D82F1

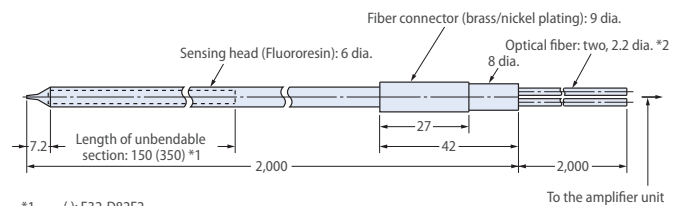

\*1. ( ) E32-D82F2

\*2. The 2-m section of optical fiber on the amplifier unit side is plastic and therefore allows free cutting.

## E32-D51R

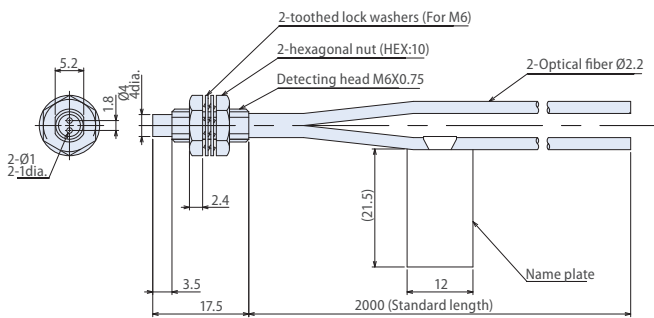

## E32-D211, E32-D211R

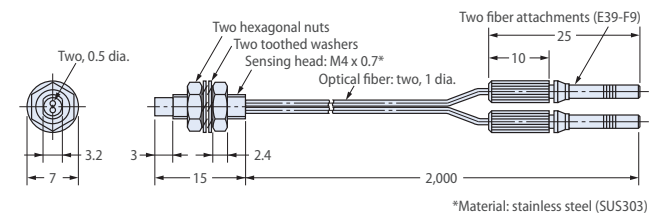

## E32-D61-S, E32-D61

### Using the E32-D61-S

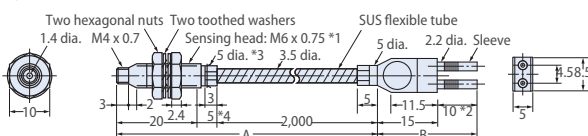

### Using the E32-D61

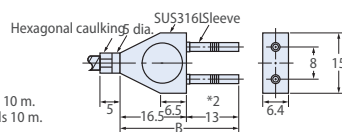

\*1. Material: stainless steel (SUS303)

\*3. The diameter is 6 if the fiber length exceeds 10 m.

\*4. The diameter is 10 if the fiber length exceeds 10 m.

## E32-D73-S, E32-D73

### Using the E32-D73-S

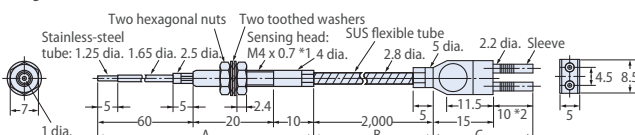

### Using the E32-D73



\*1. Material: stainless steel (SUS303)

## E32-D331

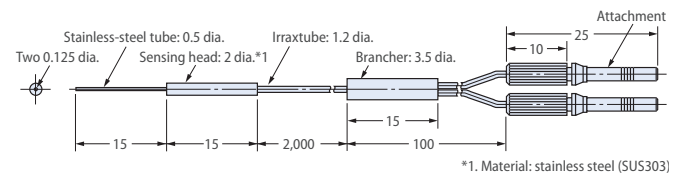

## E32-DC200

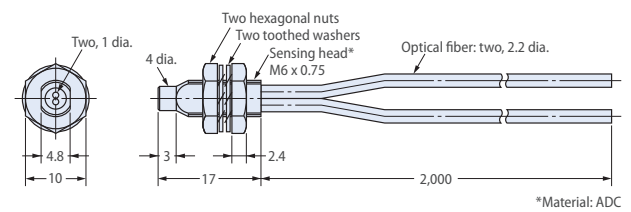

## E32-DC200B, E32-DC200BR

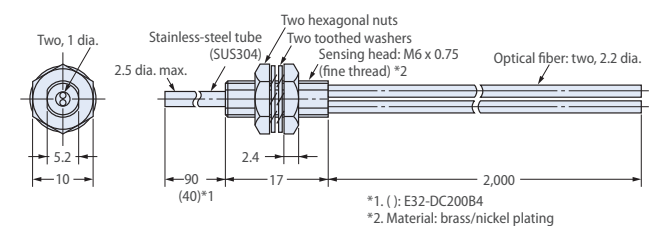

# Dimensions

## E32-DC200E

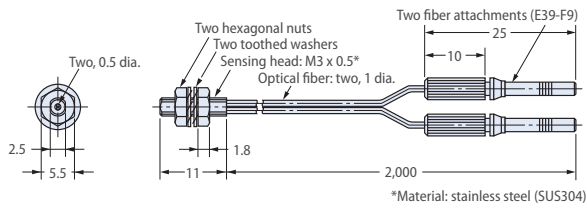

## E32-DC200F, E32-DC200FR

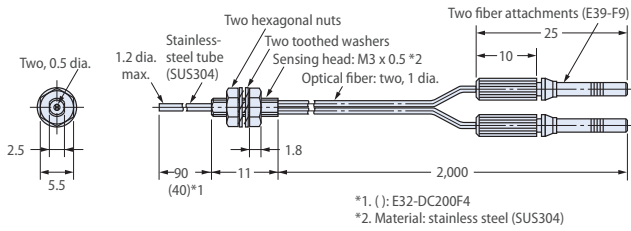

## E32-ED11F

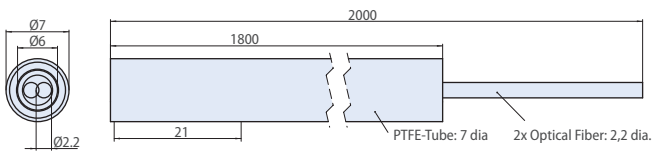

## E32-EDS24R

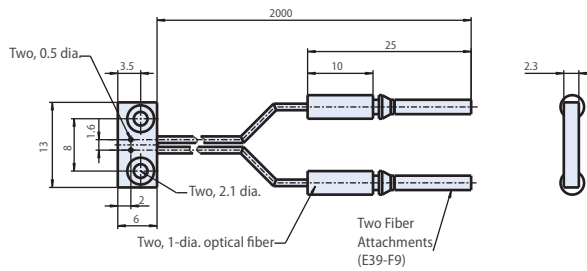

## E32-EL24-1

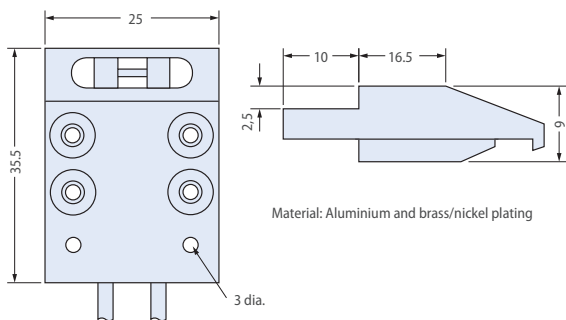

## E32-ET15YR-1

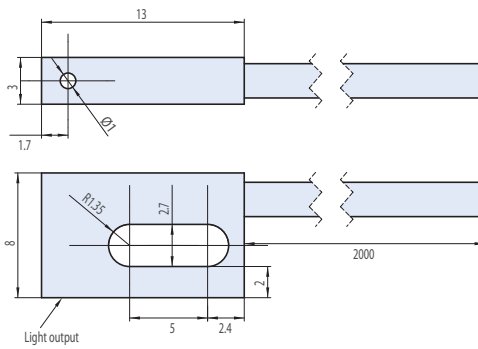

## E32-ET15ZR-1

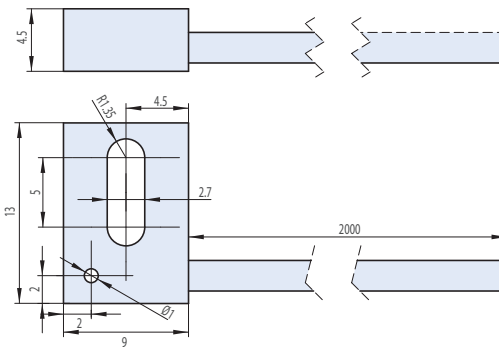

## E32-ET16WR-1

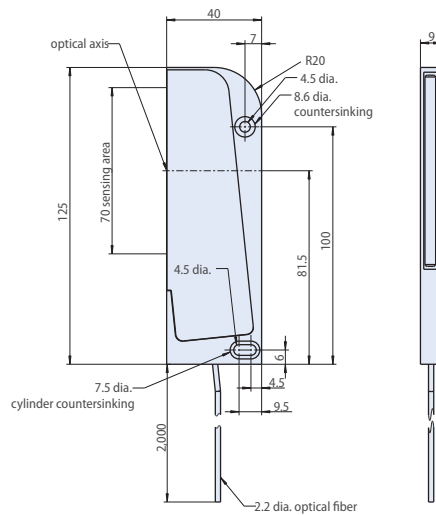

# Dimensions

**E32-ET16WR-2**

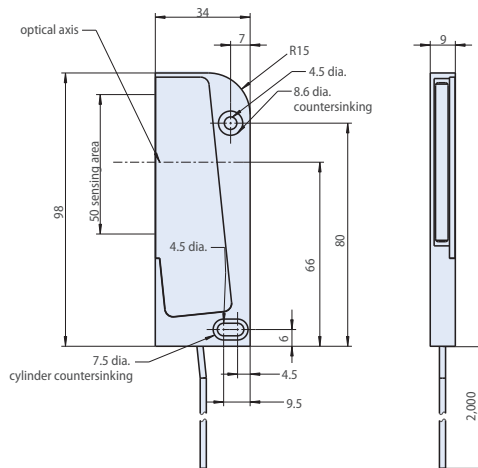

**E32-L11FS**

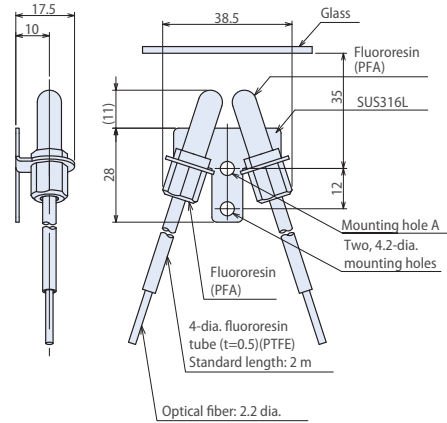

**E32-ETC220 2M**

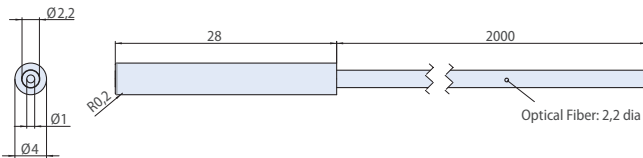

**E32-L15**

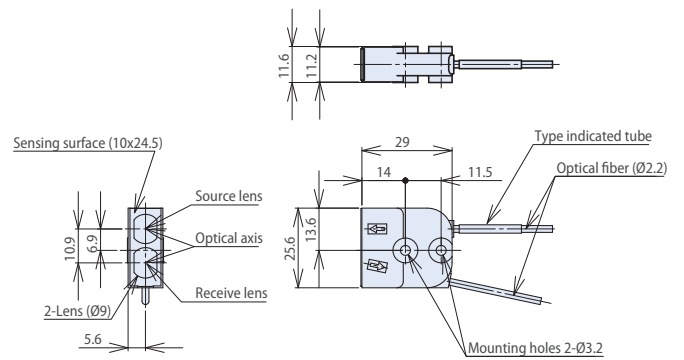

**E32-ETS10R**

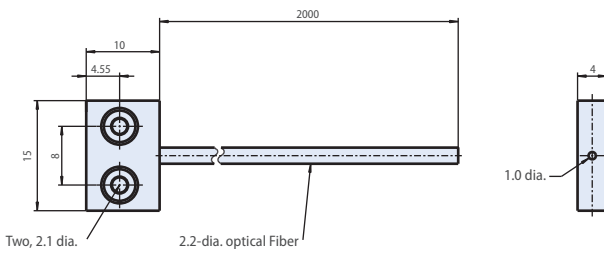

**E32-L16-N**

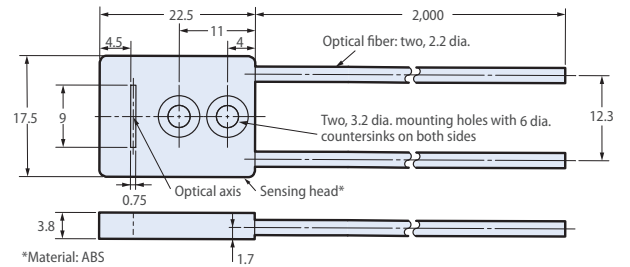

**E32-ETS14R**

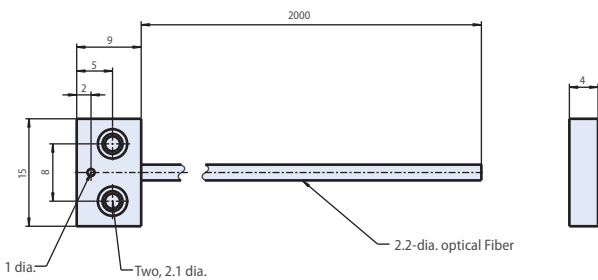

**E32-L24L**

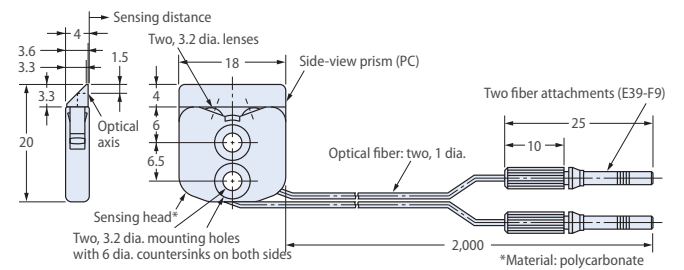

**E32-G14**

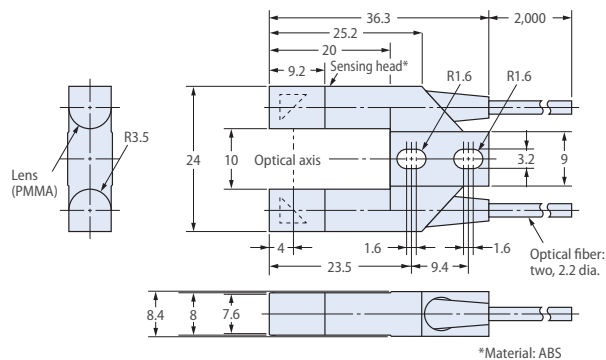

**E32-L25**

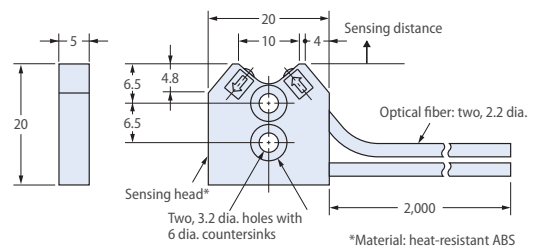

# Dimensions

## E32-L25L

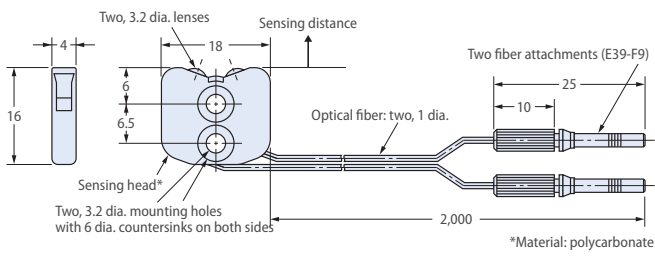

## E32-L64

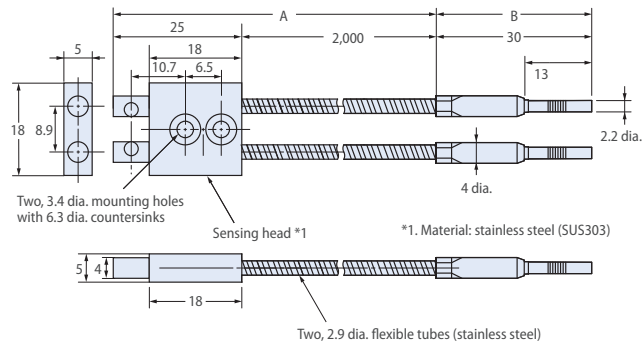

## E32-L66

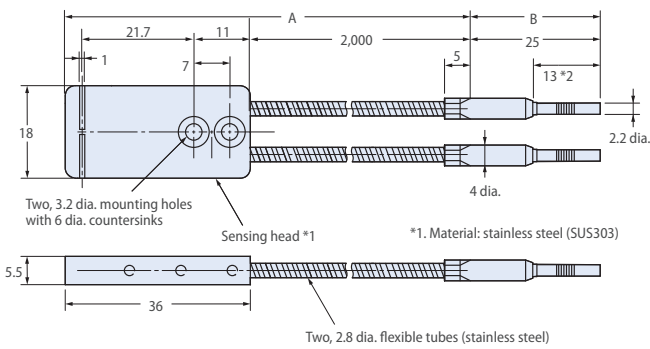

## E32-LD11/LD11 R

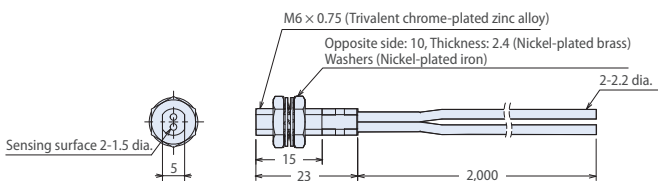

## E32-LD11N

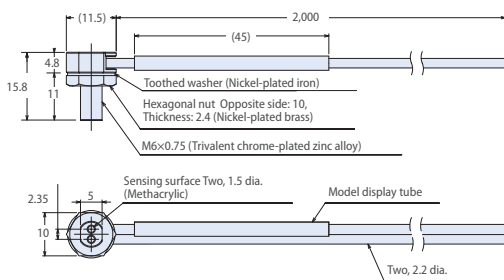

## E32-LR11NP

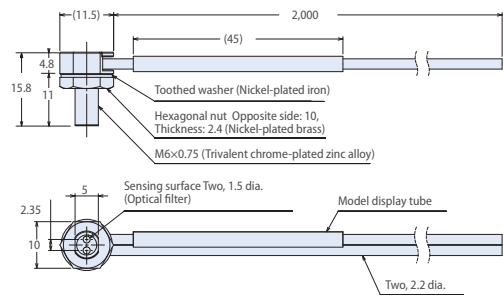

## E32-LT11/LT11 R

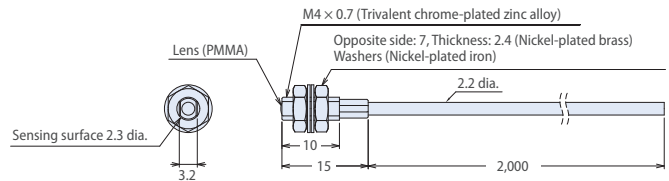

## E32-LT11N

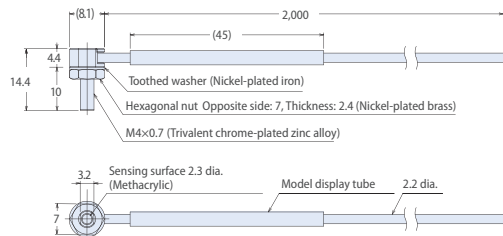

## E32-M21

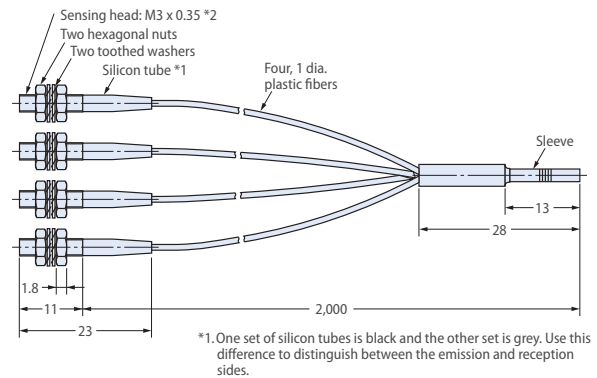

## E32-R16

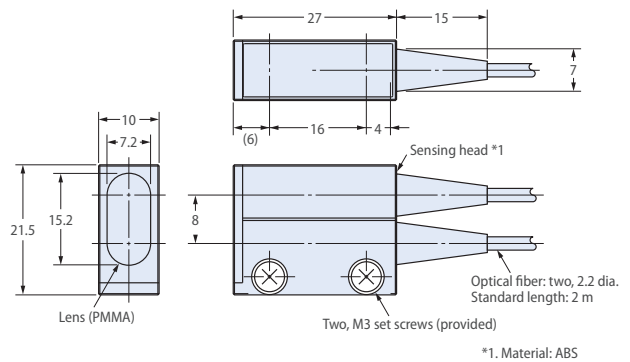



# Dimensions

## E32-R21

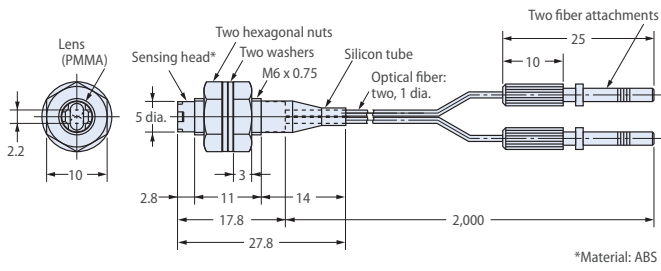

## E32-T11, E32-T11U

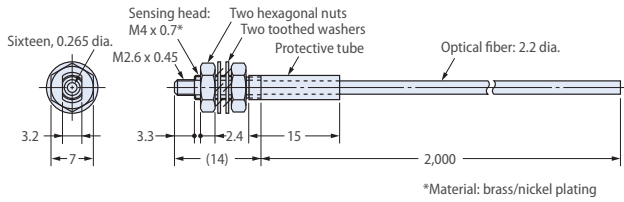

## E32-T11N

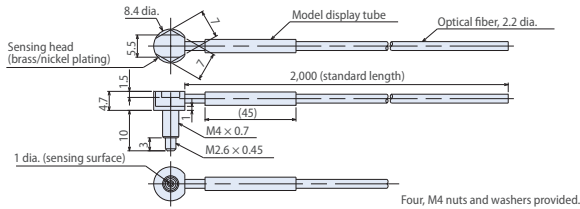

## E32-T11R

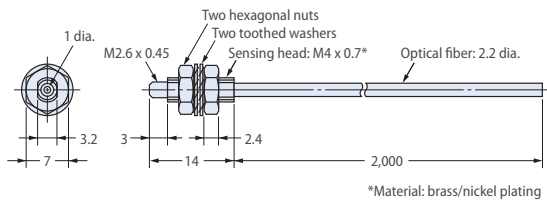

## E32-T12, E32-T12R

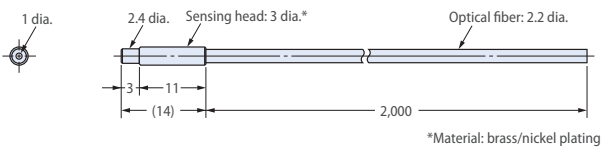

## E32-T12B

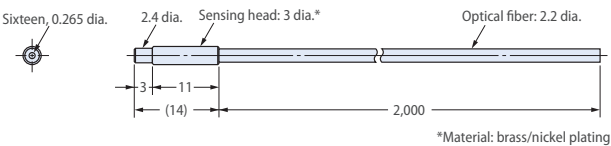

## E32-T12F

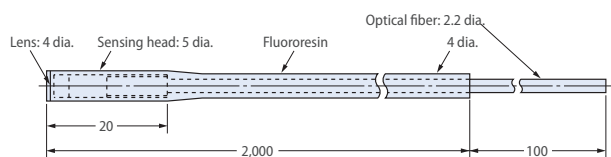

## E32-T12L

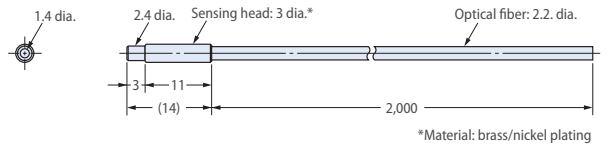

## E32-T14

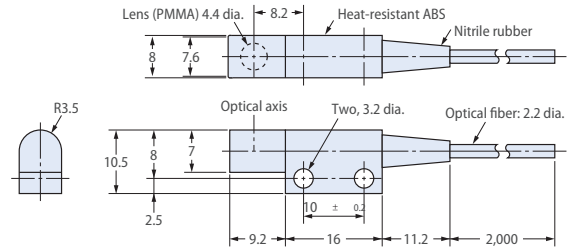

## E32-T14F

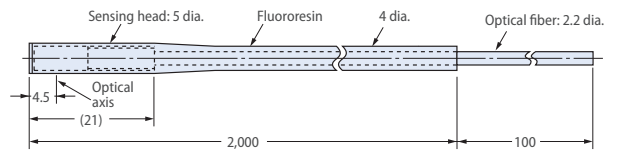

## E32-T14L, E32-T14LR

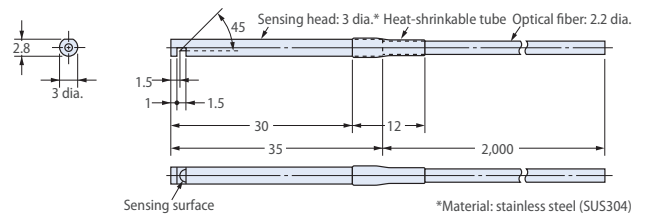

## E32-T15X

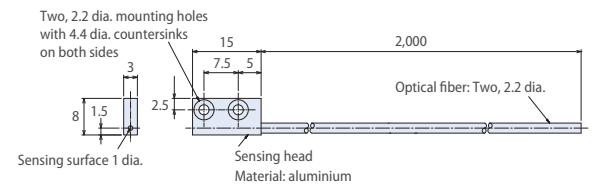

## E32-T15XB

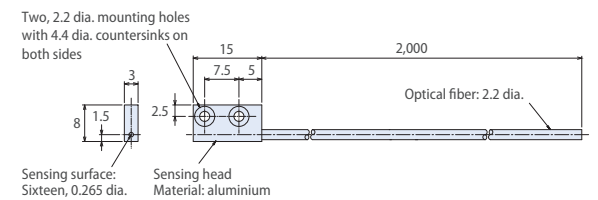

## E32-T15Y, E32-T15YR

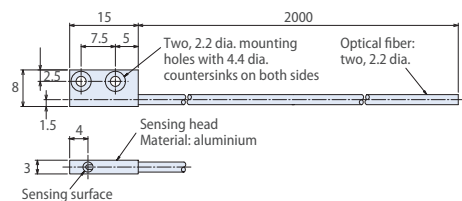

# Dimensions

## E32-T15Z

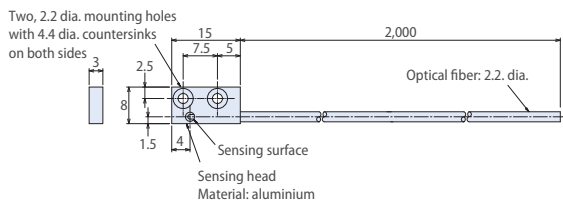

## E32-T16

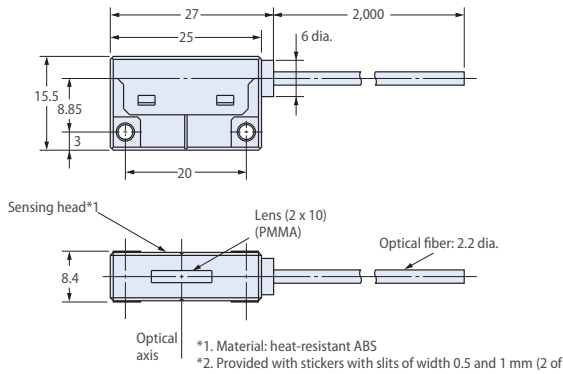

## E32-T16J, E32-T16JR

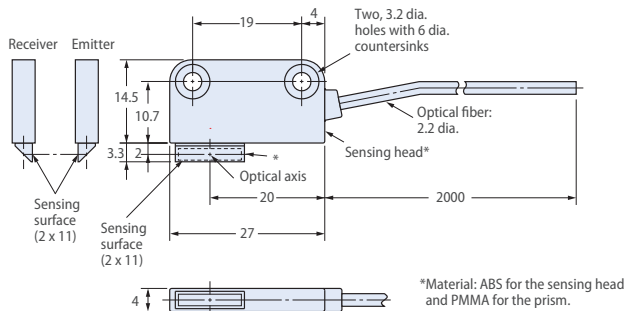

## E32-T16P, E32-T16PR

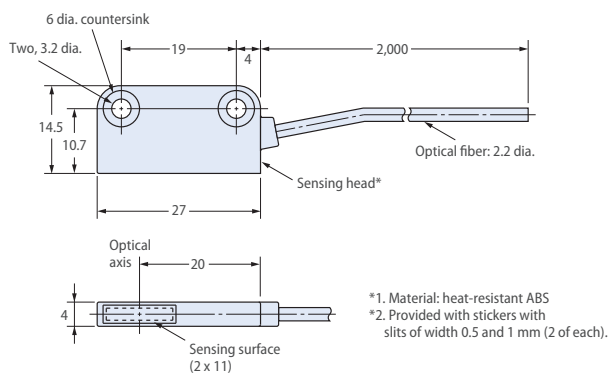

## E32-T16W, E32-T16WR

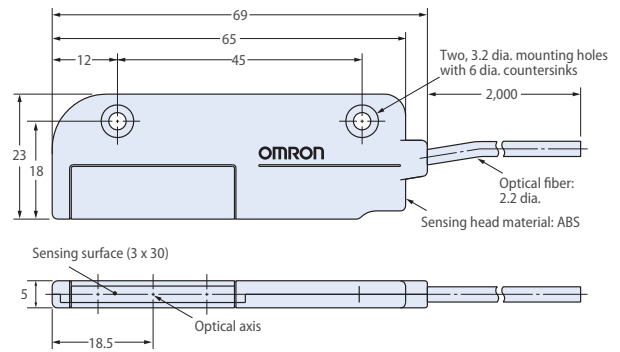

## E32-T17L

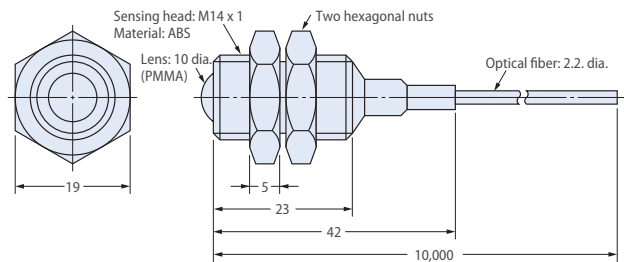

## E32-T21

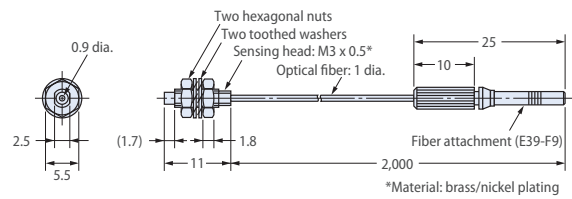

## E32-T21R

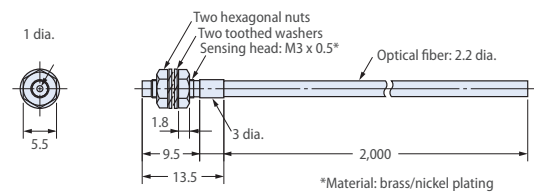

## E32-T22, E32-T22R

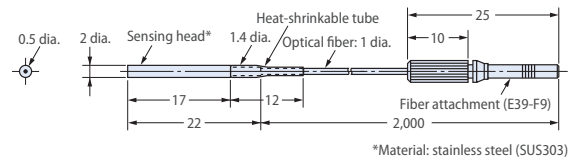

## E32-T22B

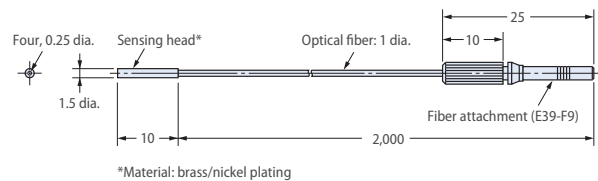

# Dimensions

## E32-T22L

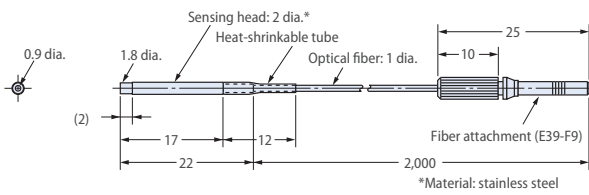

## E32-T51V

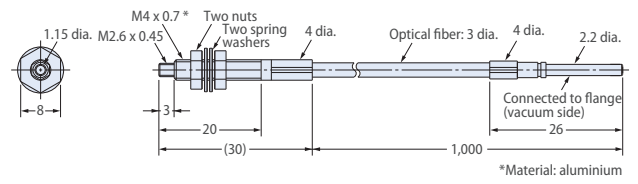

## E32-T22S

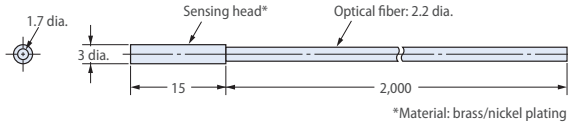

## E32-T54

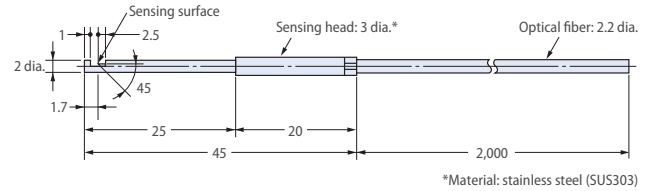

## E32-T24, E32-T24R

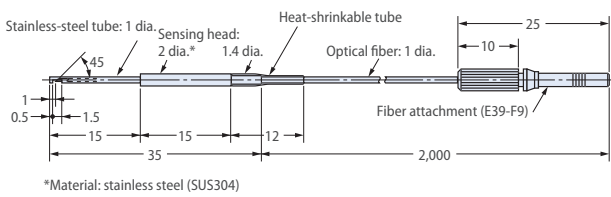

## E32-T54V

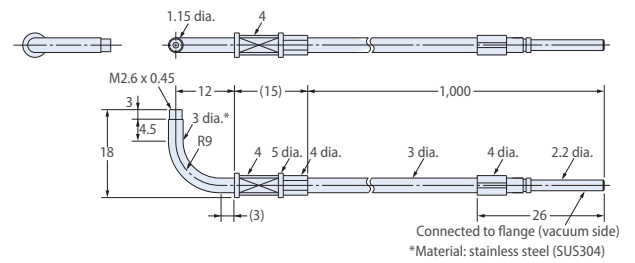

## E32-T24S

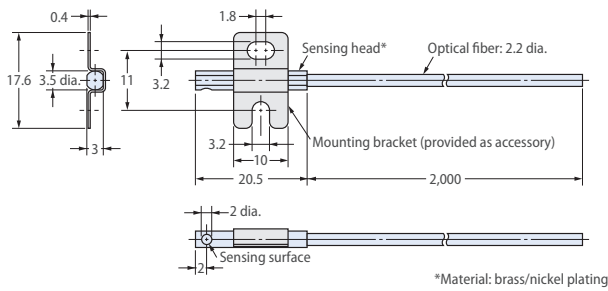

## E32-T61-S

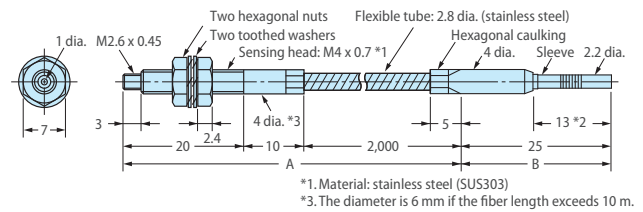

## E32-T51

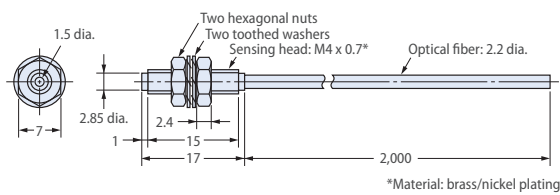

## E32-T81F-S

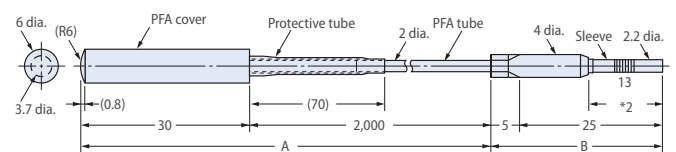

## E32-T51F

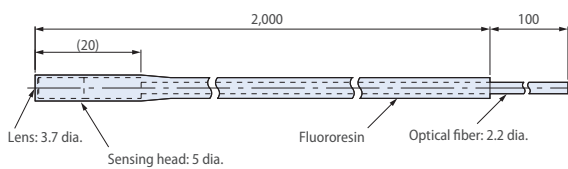

## E32-T81R-S

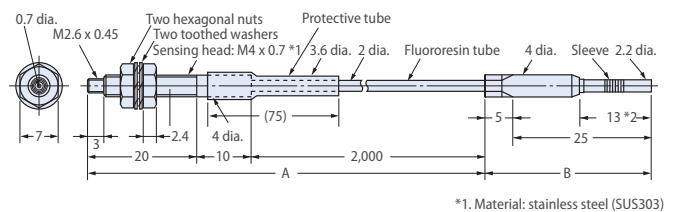

## E32-T51R

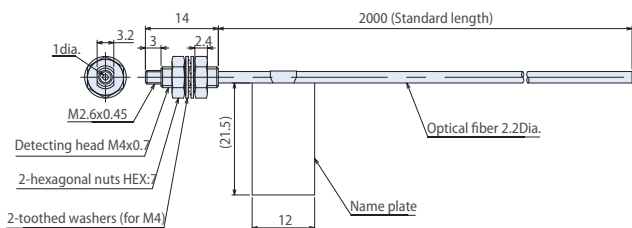

# Dimensions

## E32-T845-S

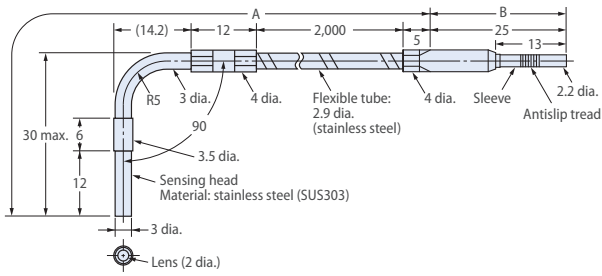

## E32-T845V

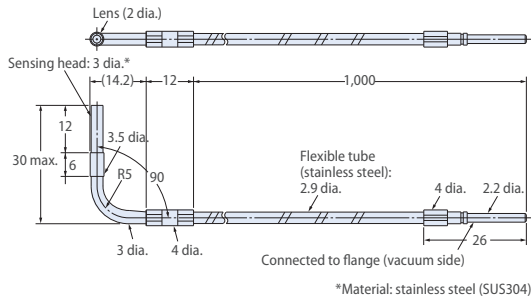

## E32-T221B

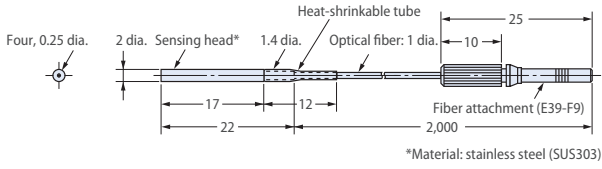

## E32-T222, E32-T222R

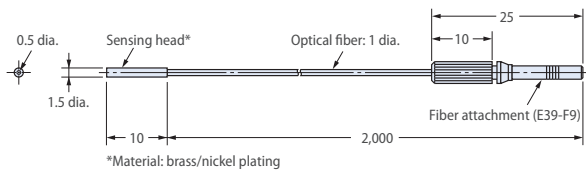

## E32-T223R

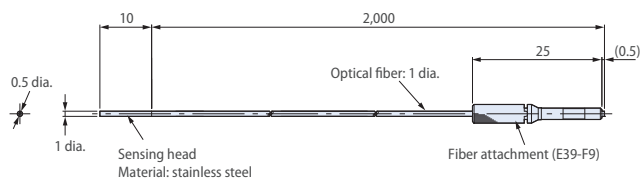

## E32-TC200

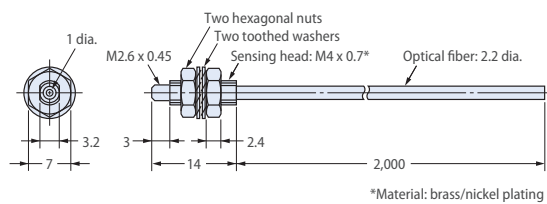

## E32-TC200A

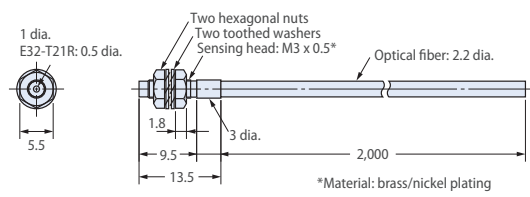

## E32-TC200B, E32-TC200BR

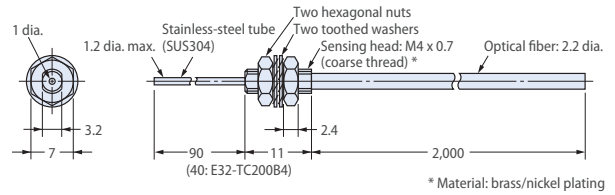

## E32-TC200E

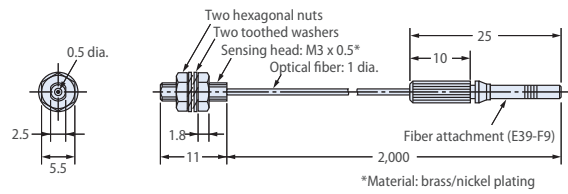

## E32-TC200F, E32-TC200FR

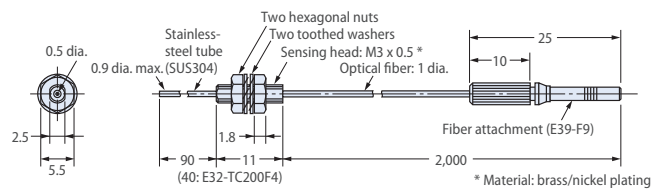

## E39-EF1-37

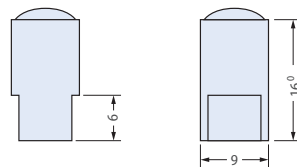

## E39-EF51

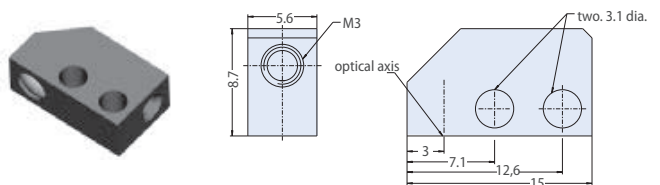

## E39-F1

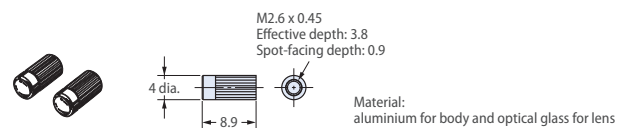

# Dimensions

## E39-F1V

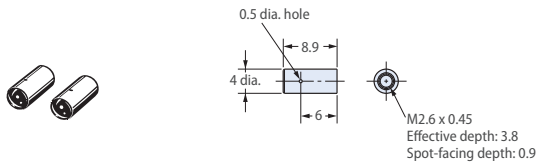

## E39-F2

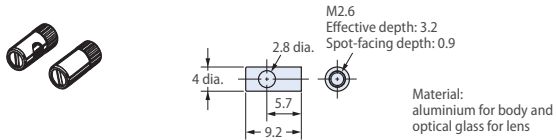

## E39-F3A

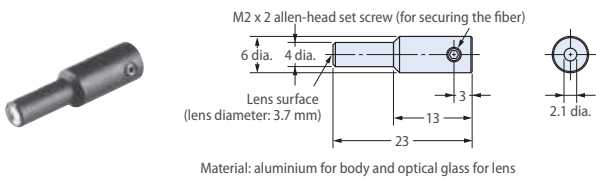

## E39-F3A-5

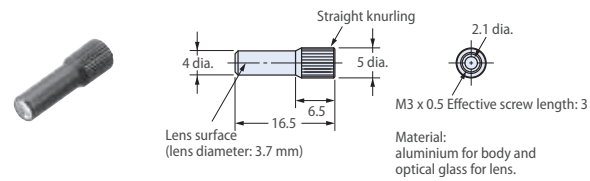

## E39-F3B

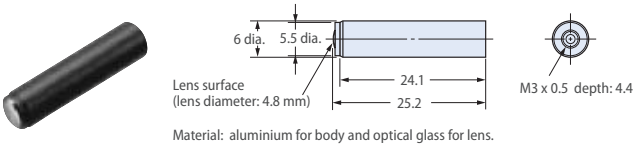

## E39-F4

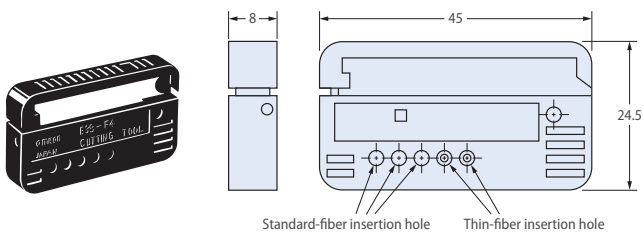

## E39-F9

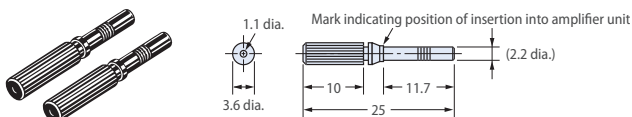

## E39-F10

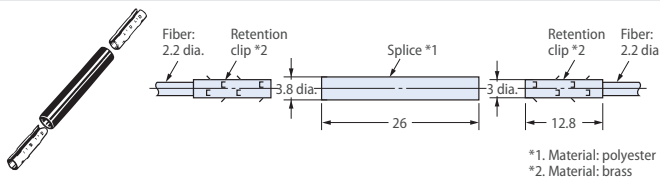

## E39-F11

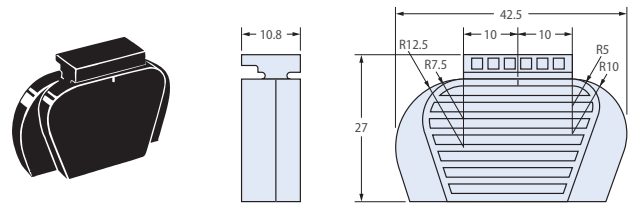

## E39-F13, E39-F14, E39-F15

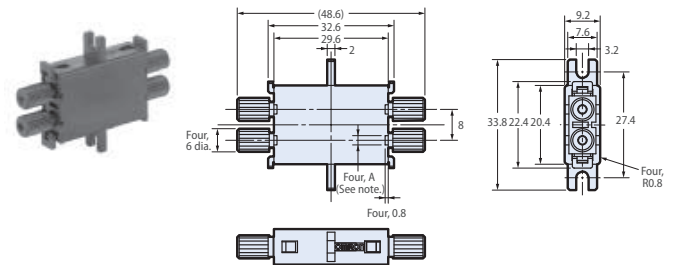

## E39-F16

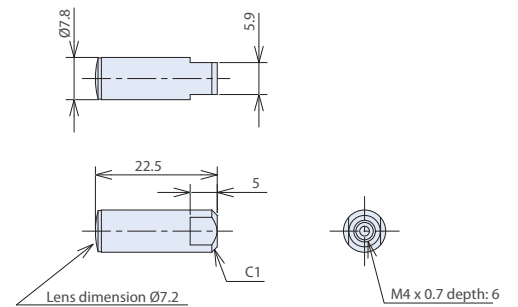

## E39-F18

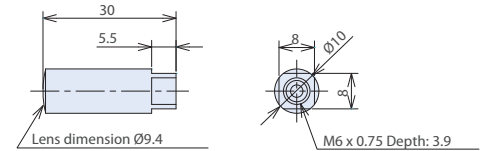

## E39-F32A, E39-F32B

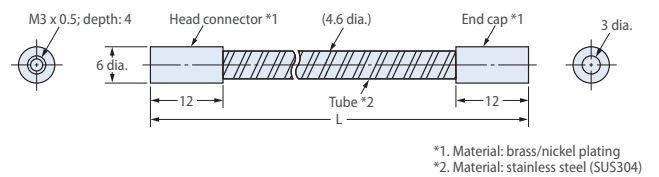

## E39-F32C

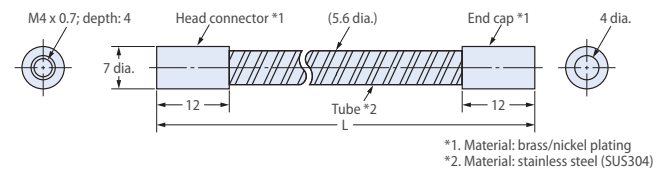

## E39-F32D

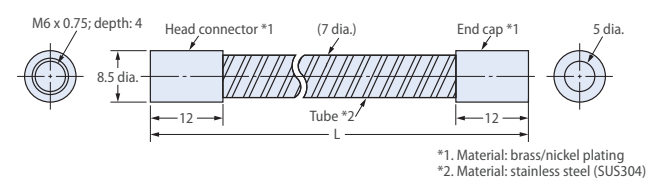









# Dimensions

## E3X-SD\_ amplifiers - exemplary drawing for pre-wired version

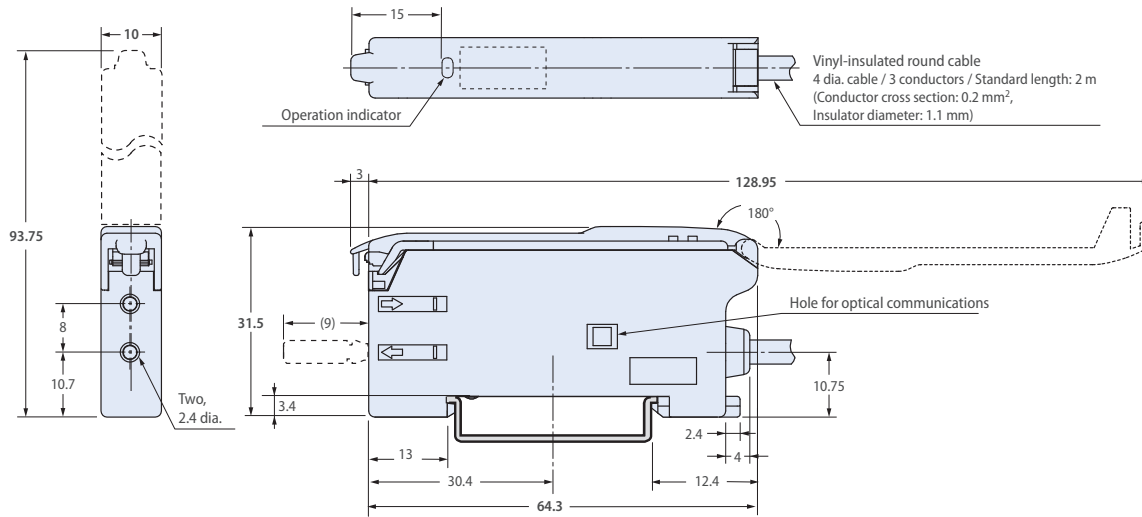

# Precautions

## Fiber Units

### Installation

#### Tightening Force

The tightening force applied to the Fiber Unit should be as follows:

#### Screw-mounting model

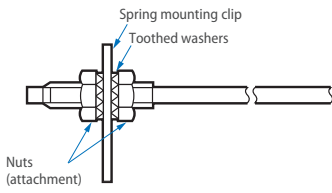

#### Cylindrical model

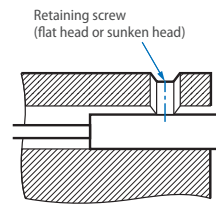

Fiber Units	Clamping torque
M3/M4 screw	0.78 Nm max.
M6 screw/6-mm dia. column	0.98 Nm max.
1.5-mm dia. column	0.2 Nm max.
2-mm dia./3-mm dia. column	0.29 Nm max.
E32-T12F 5-mm dia. fluororesin model	0.78 Nm max.
E32-D12F 6-mm dia. fluororesin model	
E32-T16	0.49 Nm max.
E32-R21	0.59 Nm max.
E32-M21	0.49 Nm max. for up to 5 mm from front end, 0.78 Nm max. for more than 5 mm from front end
E32-T16P E32-T16PR E32-T24S E32-L24L E32-L25L E32-T16J E32-T16JR	0.29 Nm max.
E32-ET16W E32-ET16WR	0.3 Nm max.

Use a proper-sized wrench.

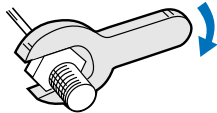

### Cutting Fiber

- Insert a fiber into the Fiber Cutter and determine the length of the fiber to be cut.
- Press down the Fiber Cutter in a single stroke to cut the fiber.
- Cut a thin fiber as follows:

①	An attachment is temporarily fitted to a thin fiber before shipment.	
②	Secure the attachment after adjusting the position of it in the direction indicated by the arrow.	
③	Insert the fiber to be cut into the E39-F4.	
④	Finished state (proper cutting state)	

### Connection

- Do not pull or press the fiber units. The fiber units withstand tensile or compression force of 9.8 N or 29.4 N maximum.
- Do not bend the fiber unit beyond the permissible bending radius given under Ordering Information.
- Do not bend the edge of the fiber units (excluding the E32-T□R and E32-D□R).

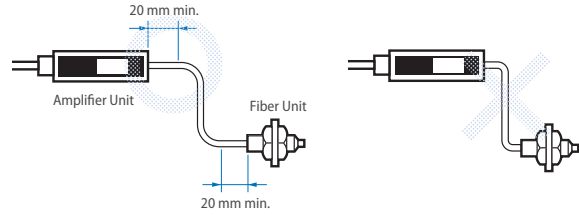

- Do not apply excess force on the fiber units.

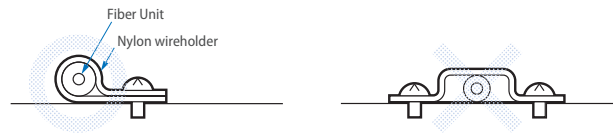

- The fiber head may break due to excessive vibration. A one turn loop may reduce the effect of vibrations:

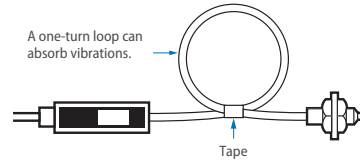

### E39-F11 Sleeve Bender

- The bending radius of the stainless steel tube should be as large as possible. The smaller the bending radius becomes, the shorter the sensing distance will be.
- Insert the tip of the stainless steel tube to the sleeve bender and bend the stainless steel tube slowly along the curve of the sleeve bender (refer to the figure).

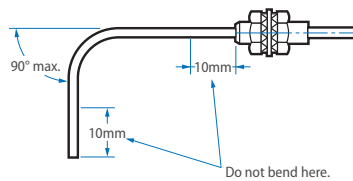
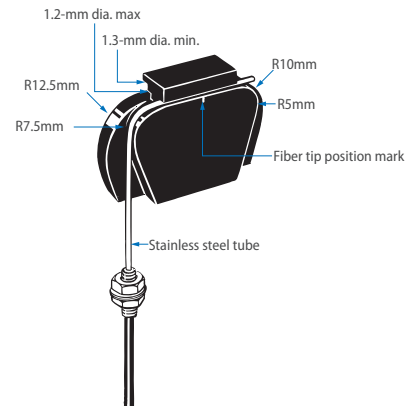

# Precautions

## Heat-resistant fibers

- The fiber connector E39-F10 cannot be used for extension.

## E32-T14/E32-G14

The presence of a reflective object at the front ends of the lenses may place the unit in an incident state. In this case, apply the supplied black stickers to the front ends of the lenses.

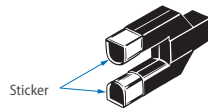

## Supplied slit for E32-T16

When using the supplied slit, peel off the back paper and apply it along the outline of the sensing surface. The slit is recommended in applications where saturation occurs.

## E32-M21

To prevent mutual interference sufficient distance between the four sensing heads has to be ensured.

## Adjustment

### E32-G14

Due to the short distance between the sensor heads, two-point teaching (with and without object) is recommended.

## Example

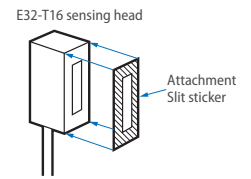

## Accessories

### Protective Spiral Tubes

- Insert a fiber to the protective spiral tube from the head connector side (screwed) of the tube.

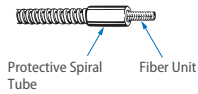

- Push the fiber into the protective spiral tube. The tube should be straight so that the fiber is not twisted when inserted. Then turn the end cap of the spiral tube.

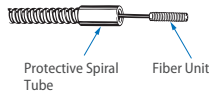

- Secure the protective spiral tube at a suitable place with the attached nut.

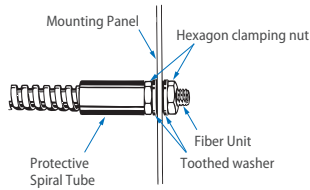

**Note:** Only 2.2 mm dia. fibers can be connected.

- Use the attached saddle to secure the end cap of the protective spiral tube. To secure the protective spiral tube at a position other than the end cap, apply tape to the tube so that the portion becomes thicker in diameter.

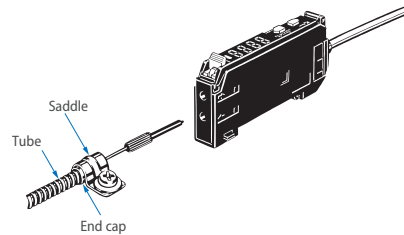

### E39-F10 Fiber Connector

Fit the connector in the following procedure.

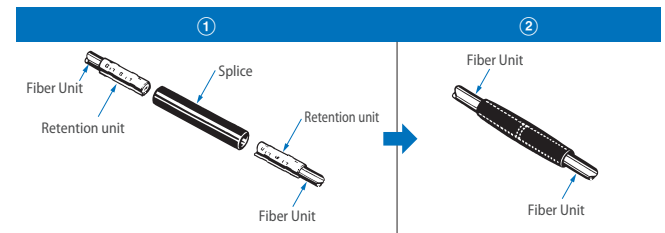

- The fiber units should be as close as possible when they are connected. Sensing distance will be reduced by approximately 25% when fibers are connected.

# Precautions

## Amplifier Unit

### Installation

#### Operation after Turning Power ON

The Amplifier Unit is ready to operate within 200 ms after the power supply is turned ON. If the Sensor and load are connected to power supplies separately, be sure to turn ON the power supply to the Sensor first.

### Mounting

#### Connecting and Disconnecting Connectors

#### Mounting Connectors

1. Insert the Master or Slave Connector into the Amplifier Unit until it clicks into place.

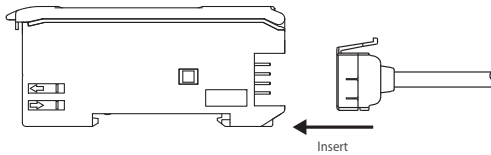

2. Attach the protector seals (provided as accessories) to the sides of master and slave connectors that are not connected.

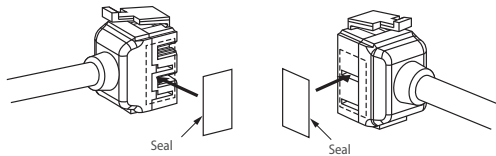

**Note:** Attach the seals to the sides with grooves

#### Removing Connectors

1. Slide the slave Amplifier Unit(s) for which the Connector is to be removed away from the rest of the group.
2. After the Amplifier Unit(s) has been separated, press down on the lever on the Connector and remove it. (Do not attempt to remove Connectors without separating them from other Amplifier Units first.)

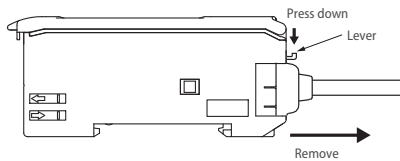

### Joining and Removing Amplifier Units

#### Joining Amplifier Units

1. Mount the Amplifier Units one at a time onto the DIN track.

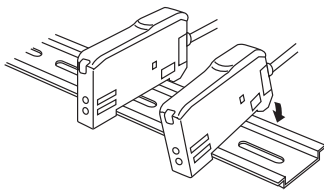

2. Slide the Amplifier Units together, line up the clips, and press the Amplifier Units together until they click into place.

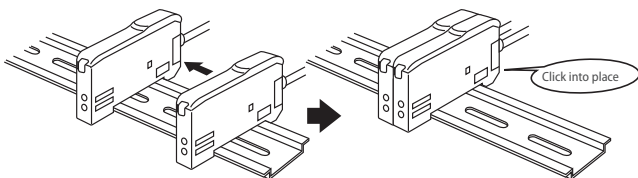

#### Separating Amplifier Units

Slide Amplifier Units away from each other, and remove from the DIN track one at a time. (Do not attempt to remove Amplifier Units from the DIN track without separating them first.)

- Note:**
- The specifications for ambient temperature will vary according to the number of Amplifier Units used together. For details, refer to Ratings/Characteristics.
  - Always turn OFF the power supply before joining or separating Amplifier Units.

### Mounting the End Plate (PFP-M)

An End Plate should be used if there is a possibility of the Amplifier Unit moving, e.g., due to vibration. If a Mobile Console is going to be mounted, connect the End Plate in the direction shown in the following diagram.

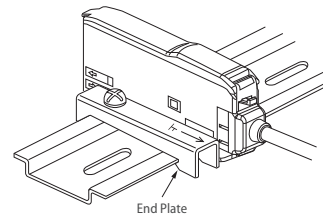

### Mounting the Mobile Console Head

Leave a gap of at least 20 mm between the nearest Amplifier Unit and the Mobile Console head.

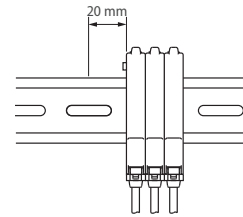

### Fiber Connection

The E3X Amplifier Unit has a lock button for easy connection of the Fiber Unit. Connect or disconnect the fibers using the following procedures:

#### 1. Connection

Open the protective cover, insert the fibers according to the fiber insertion marks on the side of the Amplifier Unit, and lower the lock button.

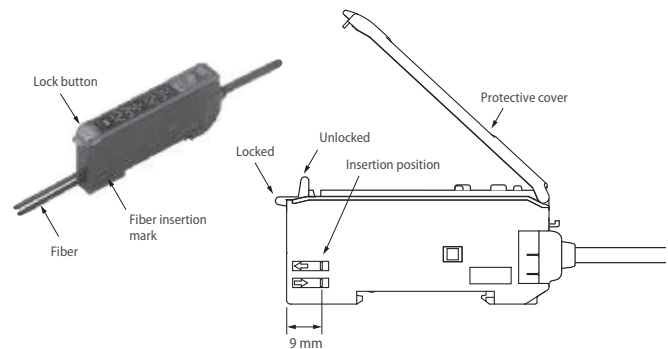

#### Fibers with E39-F9 Attachment

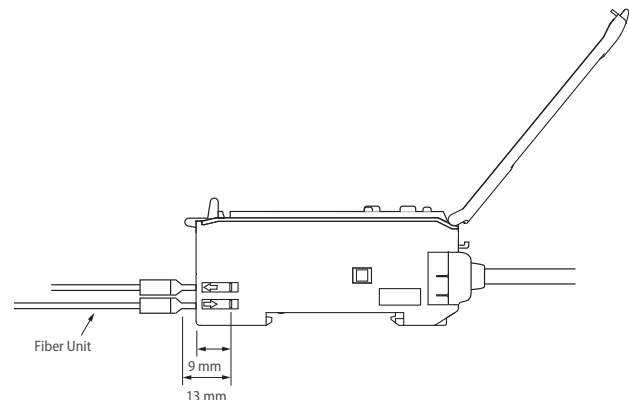

# Precautions

## Fibers That Cannot Be Free-Cut (with Sleeves)

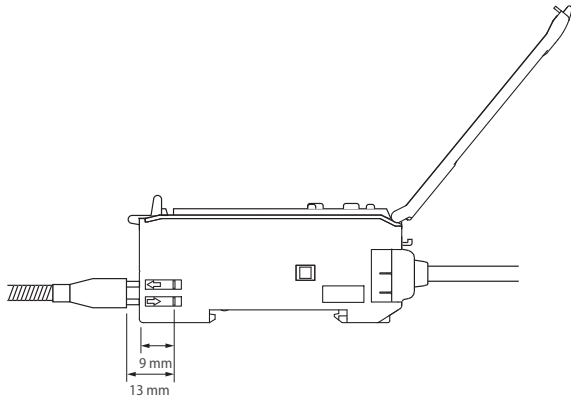

### 2. Disconnecting Fibers

Remove the protective cover and raise the lock button to pull out the fibers.

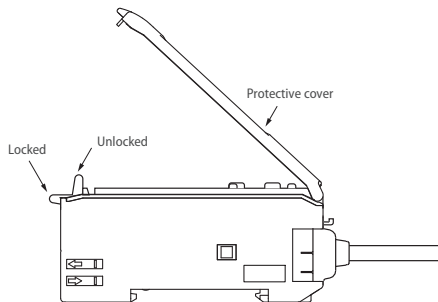

- Note:**
- To maintain the fiber properties, confirm that the lock is released before removing the fibers.
  - Be sure to lock or unlock the lock button within an ambient temperature range between  $-10^{\circ}\text{C}$  and  $40^{\circ}\text{C}$ .

### Protective Cover

Always keep the protective cover in place when using the Amplifier Unit.

- Note:** For complete precautions and installation instructions refer to individual amplifier datasheets.

# Product list

Order code	Group	Page
E32-A03 2M	Precision detection	21
	Special application	24
E32-A03-1 2M	Square shape	10
E32-A04 2M	Miniature	12
	Precision detection	21
	Special application	24
E32-A04-1 2M	Square shape	10
E32-A09 2M	Precision detection	21
	Special application	24
E32-A09H 2M	Heat resistant	17
E32-A09H2 2M	Heat resistant	17
E32-A10 2M	Special application	24
E32-C11N 2M	Precision detection	21
E32-C21N 2M	Precision detection	21
E32-C31 2M	Precision detection	21
	Special application	24
E32-C31N 2M	Precision detection	21
E32-C41 1M	Precision detection	21
	Precision detection	21
E32-CC200 2M	Precision detection	21
	Special application	24
E32-D11 2M	Robot applications	20
E32-D11L 2M	Longer distance	14
E32-D11N 2M	Standard cylindrical	8
E32-D11R 2M	Standard cylindrical	8
E32-D11U 2M	Chemical resistant	16
E32-D12 2M	Longer distance	14
E32-D12F	Chemical resistant	16
E32-D14F 2M	Chemical resistant	16
E32-D14L 2M	Standard cylindrical	8
E32-D14LR 2M	Standard cylindrical	8
E32-D15X 2M	Square shape	10
E32-D15XB 2M	Robot applications	20
E32-D15XR 2M	Square shape	10
E32-D15Y 2M	Square shape	10
E32-D15YR 2M	Square shape	10
E32-D15Z 2M	Square shape	10
E32-D16 2M	Longer distance	14
E32-D21 2M	Robot applications	20
E32-D211 2M	Standard cylindrical	8
E32-D211R 2M	Standard cylindrical	8
E32-D21B 2M	Robot applications	20
E32-D21L 2M	Longer distance	14
E32-D21N 2M	Longer distance	14
E32-D21R 2M	Standard cylindrical	8
E32-D22 2M	Miniature	12
E32-D22B 2M	Miniature	12
	Robot applications	20
E32-D22R 2M	Miniature	12
E32-D24	Miniature	12
E32-D24R 2M	Miniature	12
E32-D32 2M	Miniature	12
	Precision detection	21
E32-D32L 2M	Precision detection	21
E32-D32R 2M	Miniature	12
E32-D33 2M	Miniature	12
E32-D331 2M	Miniature	12
E32-D36P1 2M	Area monitoring	23
E32-D36T 2M	Special application	24
E32-D51 2M	Heat resistant	17
E32-D51R 2M	Heat resistant	17
E32-D61/ D61-S 2M	Heat resistant	17
E32-D73/ D73-S 2M	Heat resistant	17
E32-D81R/ D81R-S 2M	Heat resistant	17
E32-D82F1 4M	Special application	24
E32-DC200 2M	Standard cylindrical	8
E32-DC200B 2M	Miniature	12
E32-DC200BR	Miniature	12
E32-DC200E 2M	Standard cylindrical	8

Order code	Group	Page
E32-DC200F	Miniature	12
E32-DC200FR	Miniature	12
E32-E01 100M	Accessories	26
E32-E01R 100M	Accessories	26
E32-E02 100M	Accessories	26
E32-E02R 100M	Accessories	26
E32-E05 100M	Accessories	26
E32-ED11F 2M	Chemical resistant	16
E32-EDS24R 2M	Square shape	10
E32-EL24-1 2M	Precision detection	21
	Special application	24
E32-ET15YR	Square shape	10
E32-ET15ZR	Square shape	10
E32-ET16WR-1 2M	Area monitoring	23
E32-ET16WR-2 2M	Area monitoring	23
E32-ETC220 2M	Standard cylindrical	8
E32-ETS10R 2M	Square shape	10
E32-ETS14R 2M	Square shape	10
E32-G14	Special application	24
E32-L11FS	Special application	24
E32-L15	Mark detection	37
E32-L16-N 2M	Precision detection	21
E32-L24L	Precision detection	21
E32-L25	Precision detection	21
E32-L25L	Precision detection	21
	Special application	24
E32-L64	Heat resistant	17
	Special application	24
E32-L66 2M	Heat resistant	17
	Special application	24
E32-LD11	Longer distance	14
E32-LD11N 2M	Longer distance	14
E32-LD11R	Longer distance	14
E32-LR11NP 2M	Longer distance	14
E32-LT11	Longer distance	14
E32-LT11N 2M	Longer distance	14
E32-LT11R	Longer distance	14
E32-M21	Area monitoring	23
E32-R16 2M	Longer distance	14
E32-R21	Standard cylindrical	8
E32-T11 2M	Robot applications	20
E32-T11L 2M	Longer distance	14
E32-T11N 2M	Standard cylindrical	8
E32-T11R 2M	Standard cylindrical	8
E32-T11U 2M	Chemical resistant	16
E32-T12 2M	Miniature	12
E32-T12B	Robot applications	20
E32-T12F	Chemical resistant	16
E32-T12L 2M	Longer distance	14
E32-T12R 2M	Miniature	12
E32-T14 2M	Longer distance	14
E32-T14F 2M	Chemical resistant	16
E32-T14L 2M	Miniature	12
E32-T14LR 2M	Miniature	12
E32-T15X 2M	Square shape	10
E32-T15XB 2M	Robot applications	20
E32-T15Y 2M	Square shape	10
E32-T15YR 2M	Square shape	10
E32-T15Z 2M	Square shape	10
E32-T16	Area monitoring	23
E32-T16J 2M	Area monitoring	23
E32-T16JR 2M	Area monitoring	23
E32-T16P	Area monitoring	23
E32-T16PR 2M	Area monitoring	23
E32-T16W 2M	Area monitoring	23
E32-T16WR 2M	Area monitoring	23
E32-T17L	Longer distance	14
E32-T21 2M	Robot applications	20
E32-T21R 2M	Standard cylindrical	8

Order code	Group	Page
E32-T22 2M	Miniature	12
E32-T221B	Robot applications	20
E32-T222 2M	Miniature	12
E32-T222R 2M	Miniature	12
E32-T22B	Robot applications	20
E32-T22L 2M	Longer distance	14
E32-T22R 2M	Miniature	12
E32-T22S	Precision detection	21
	Special application	24
E32-T24	Miniature	12
E32-T24R 2M	Miniature	12
E32-T24S	Special application	24
E32-T51 2M	Heat resistant	17
E32-T51F 2M	Chemical resistant	16
E32-T51R 2M	Heat resistant	17
E32-T51V 1M	Vacuum resistant	19
E32-T54 2M	Heat resistant	17
E32-T54V 1M	Vacuum resistant	19
E32-T61-S 2M	Heat resistant	17
E32-T81F-S 2M	Chemical resistant	16
E32-T81R-S 2M	Heat resistant	17
E32-T84S-S 2M	Heat resistant	17
E32-T84SV 1M	Vacuum resistant	19
E32-TC200 2M	Standard cylindrical	8
E32-TC200A 2M	Longer distance	14
E32-TC200B	Miniature	12
E32-TC200BR	Miniature	12
E32-TC200E 2M	Standard cylindrical	8
E32-TC200F	Miniature	12
E32-TC200FR	Miniature	12
E39-EF1-37	Accessories	26
E39-EF51	Accessories	26
E39-F1	Accessories	26
E39-F10	Accessories	26
E39-F11	Accessories	26
E39-F13	Accessories	26
E39-F14	Accessories	26
E39-F15	Accessories	26
E39-F16	Accessories	26
E39-F18	Accessories	26
E39-F1V	Accessories	26
E39-F2	Accessories	26
E39-F32A	Accessories	26
E39-F32B	Accessories	26
E39-F32C	Accessories	26
E39-F32D	Accessories	26
E39-F3A	Accessories	26
E39-F3A-5	Accessories	26
E39-F3B	Accessories	26
E39-F4	Accessories	26
E39-F9	Accessories	26
E39-R1S	Accessories	26
E39-R3	Accessories	26
E3NX-FA	Advanced amplifiers	32
E3X-CN21	Accessories	26
E3X-CN21-M1J	Accessories	26
E3X-CN21-M3J-2	Accessories	26
E3X-DAC_-S	Advanced amplifiers	37
E3X-DAH-S	Advanced amplifiers	39
E3X-HD	Easy usage amplifiers	27
E3X-MDA_	Advanced amplifiers	35
E3X-NA	Easy usage amplifiers	31
E3X-NA_F	Advanced amplifiers	36
E3X-SD	Easy usage amplifiers	30

## READ AND UNDERSTAND THIS DOCUMENT

---

Please read and understand this document before using the products. Please consult your OMRON representative if you have any questions or comments.

## WARRANTY

---

OMRON's exclusive warranty is that the products are free from defects in materials and workmanship for a period of one year (or other period if specified) from date of sale by OMRON.

OMRON MAKES NO WARRANTY OR REPRESENTATION, EXPRESS OR IMPLIED, REGARDING NON-INFRINGEMENT, MERCHANTABILITY, OR FITNESS FOR PARTICULAR PURPOSE OF THE PRODUCTS. ANY BUYER OR USER ACKNOWLEDGES THAT THE BUYER OR USER ALONE HAS DETERMINED THAT THE PRODUCTS WILL SUITABLY MEET THE REQUIREMENTS OF THEIR INTENDED USE. OMRON DISCLAIMS ALL OTHER WARRANTIES, EXPRESS OR IMPLIED.

## LIMITATIONS OF LIABILITY

---

OMRON SHALL NOT BE RESPONSIBLE FOR SPECIAL, INDIRECT, OR CONSEQUENTIAL DAMAGES, LOSS OF PROFITS OR COMMERCIAL LOSS IN ANY WAY CONNECTED WITH THE PRODUCTS, WHETHER SUCH CLAIM IS BASED ON CONTRACT, WARRANTY, NEGLIGENCE, OR STRICT LIABILITY.

In no event shall responsibility of OMRON for any act exceed the individual price of the product on which liability is asserted.

IN NO EVENT SHALL OMRON BE RESPONSIBLE FOR WARRANTY, REPAIR, OR OTHER CLAIMS REGARDING THE PRODUCTS UNLESS OMRON'S ANALYSIS CONFIRMS THAT THE PRODUCTS WERE PROPERLY HANDLED, STORED, INSTALLED, AND MAINTAINED AND NOT SUBJECT TO CONTAMINATION, ABUSE, MISUSE, OR INAPPROPRIATE MODIFICATION OR REPAIR.

## SUITABILITY FOR USE

---

THE PRODUCTS CONTAINED IN THIS DOCUMENT ARE NOT SAFETY RATED. THEY ARE NOT DESIGNED OR RATED FOR ENSURING SAFETY OF PERSONS, AND SHOULD NOT BE RELIED UPON AS A SAFETY COMPONENT OR PROTECTIVE DEVICE FOR SUCH PURPOSES. Please refer to separate catalogs for OMRON's safety rated products.

OMRON shall not be responsible for conformity with any standards, codes, or regulations that apply to the combination of products in the customer's application or use of the product.

At the customer's request, OMRON will provide applicable third party certification documents identifying ratings and limitations of use that apply to the products. This information by itself is not sufficient for a complete determination of the suitability of the products in combination with the end product, machine, system, or other application or use.

The following are some examples of applications for which particular attention must be given. This is not intended to be an exhaustive list of all possible uses of the products, nor is it intended to imply that the uses listed may be suitable for the products:

- Outdoor use, uses involving potential chemical contamination or electrical interference, or conditions or uses not described in this document.
- Nuclear energy control systems, combustion systems, railroad systems, aviation systems, medical equipment, amusement machines, vehicles, safety equipment, and installations subject to separate industry or government regulations.
- Systems, machines, and equipment that could present a risk to life or property.

Please know and observe all prohibitions of use applicable to the products.

NEVER USE THE PRODUCTS FOR AN APPLICATION INVOLVING SERIOUS RISK TO LIFE OR PROPERTY WITHOUT ENSURING THAT THE SYSTEM AS A WHOLE HAS BEEN DESIGNED TO ADDRESS THE RISKS, AND THAT THE OMRON PRODUCT IS PROPERLY RATED AND INSTALLED FOR THE INTENDED USE WITHIN THE OVERALL EQUIPMENT OR SYSTEM.

## PERFORMANCE DATA

---

Performance data given in this document is provided as a guide for the user in determining suitability and does not constitute a warranty. It may represent the result of OMRON's test conditions, and the users must correlate it to actual application requirements. Actual performance is subject to the OMRON Warranty and Limitations of Liability.

## CHANGE IN SPECIFICATIONS

---

Product specifications and accessories may be changed at any time based on improvements and other reasons.

It is our practice to change model numbers when published ratings or features are changed, or when significant construction changes are made. However, some specifications of the product may be changed without any notice. When in doubt, special model numbers may be assigned to fix or establish key specifications for your application on your request. Please consult with your OMRON representative at any time to confirm actual specifications of purchased products.

## DIMENSIONS AND WEIGHTS

---

Dimensions and weights are nominal and are not to be used for manufacturing purposes, even when tolerances are shown.

## ERRORS AND OMISSIONS

---

The information in this document has been carefully checked and is believed to be accurate; however, no responsibility is assumed for clerical, typographical, or proofreading errors, or omissions.

## PROGRAMMABLE PRODUCTS

---

OMRON shall not be responsible for the user's programming of a programmable product, or any consequence thereof.

## COPYRIGHT AND COPY PERMISSION

---

This document shall not be copied for sales or promotions without permission.

This document is protected by copyright and is intended solely for use in conjunction with the product. Please notify us before copying or reproducing this document in any manner, for any other purpose. If copying or transmitting this document to another, please copy or transmit it in its entirety.



**Austria**

Tel: +43 (0) 2236 377 800  
[www.industrial.omron.at](http://www.industrial.omron.at)

**Belgium**

Tel: +32 (0) 2 466 24 80  
[www.industrial.omron.be](http://www.industrial.omron.be)

**Czech Republic**

Tel: +420 234 602 602  
[www.industrial.omron.cz](http://www.industrial.omron.cz)

**Denmark**

Tel: +45 43 44 00 11  
[www.industrial.omron.dk](http://www.industrial.omron.dk)

**Finland**

Tel: +358 (0) 207 464 200  
[www.industrial.omron.fi](http://www.industrial.omron.fi)

**France**

Tel: +33 (0) 1 56 63 70 00  
[www.industrial.omron.fr](http://www.industrial.omron.fr)

**Germany**

Tel: +49 (0) 2173 680 00  
[www.industrial.omron.de](http://www.industrial.omron.de)

**Hungary**

Tel: +36 1 399 30 50  
[www.industrial.omron.hu](http://www.industrial.omron.hu)

**Italy**

Tel: +39 02 326 81  
[www.industrial.omron.it](http://www.industrial.omron.it)

**Netherlands**

Tel: +31 (0) 23 568 11 00  
[www.industrial.omron.nl](http://www.industrial.omron.nl)

**Norway**

Tel: +47 (0) 22 65 75 00  
[www.industrial.omron.no](http://www.industrial.omron.no)

**Poland**

Tel: +48 (0) 22 645 78 60  
[www.industrial.omron.pl](http://www.industrial.omron.pl)

**Portugal**

Tel: +351 21 942 94 00  
[www.industrial.omron.pt](http://www.industrial.omron.pt)

**Russia**

Tel: +7 495 648 94 50  
[www.industrial.omron.ru](http://www.industrial.omron.ru)

**South-Africa**

Tel: +27 (0)11 579 2600  
[www.industrial.omron.co.za](http://www.industrial.omron.co.za)

**Spain**

Tel: +34 913 777 900  
[www.industrial.omron.es](http://www.industrial.omron.es)

**Sweden**

Tel: +46 (0) 8 632 35 00  
[www.industrial.omron.se](http://www.industrial.omron.se)

**Switzerland**

Tel: +41 (0) 41 748 13 13  
[www.industrial.omron.ch](http://www.industrial.omron.ch)

**Turkey**

Tel: +90 216 474 00 40  
[www.industrial.omron.com.tr](http://www.industrial.omron.com.tr)

**United Kingdom**

Tel: +44 (0) 870 752 08 61  
[www.industrial.omron.co.uk](http://www.industrial.omron.co.uk)

**More Omron representatives**  
[www.industrial.omron.eu](http://www.industrial.omron.eu)

*Authorised Distributor:***Control Systems**

• Programmable logic controllers • Human-machine interfaces • Remote I/O

**Motion & Drives**

• Motion controllers • Servo systems • Inverters

**Control Components**

• Temperature controllers • Power supplies • Timers • Counters • Programmable relays  
• Digital panel indicators • Electromechanical relays • Monitoring products • Solid-state relays  
• Limit switches • Pushbutton switches • Low voltage switch gear

**Sensing & Safety**

• Photoelectric sensors • Inductive sensors • Capacitive & pressure sensors • Cable connectors  
• Displacement & width-measuring sensors • Vision systems • Safety networks • Safety sensors  
• Safety units/relay units • Safety door/guard lock switches