

Vacuum micromanipulator

Vacuum micromanipulator

- Professional vacuum system for precise handling of tiny SMD components and silicon wafers
- Suitable for assembly and laboratory work



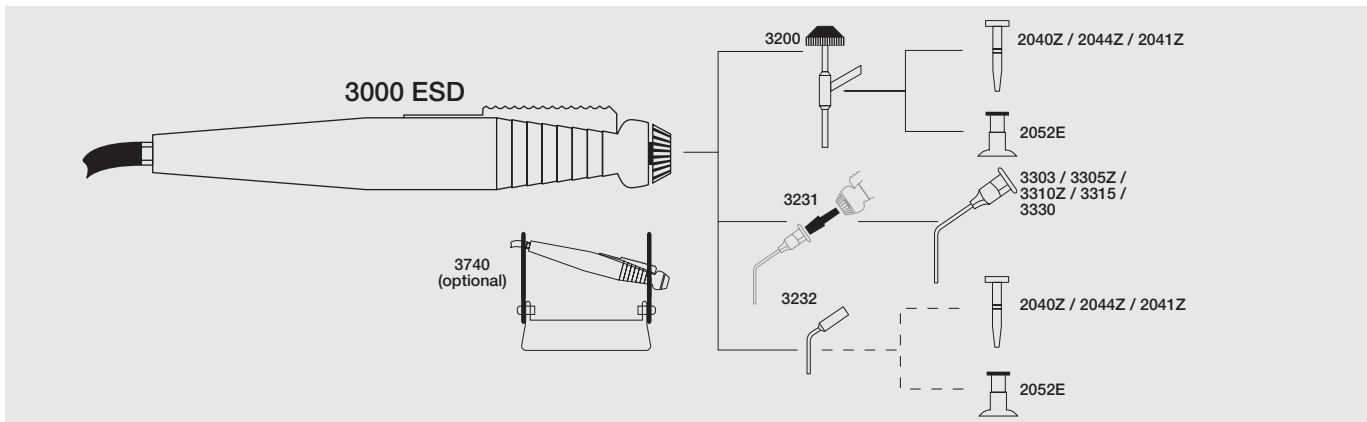

Advantages of the vacuum micromanipulator:

- Easy picking up of components or silicone wafers
- Immediate set-down/release of parts
- Full 360° rotating system
- Direct axial switch for vacuum
- Ergonomic shape reduces hand and wrist fatigue
- ESD-safe



Handle



 140 mm / 5.512 Inch
 35 g

- Ergonomic handle with axial switch, serrated finger grip for secure handling.

Model	Dimensions in mm/Inch	
3000ESD	Dia. 10 mm .394 Inch	Handle

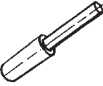
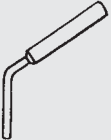

Inserts for 3000ESD housing

Adapters

Model			Description
3200	 25 mm .984 Inch	15 g	Stainless-steel adapter, rotatable through 360°, straight suction tip for direct working or as an adapter for suction tips or suction cups
3231	 5 mm .197 Inch	5 g	Adapter fix, for working with Series 3300 suction tips
3232	 15 mm total .590 Inch	3 g	Adapter fix, for direct working or as an adapter for suction tips 20442/20412 or suction cup 2052E

Suction tips, straight

- Polyethylene suction tip.
- For working with 3200 or 3232 adapter.



Model		Outside diameter	Inside diameter
2044Z		1.3 mm .051 Inch	0.9 mm .035 Inch
2041Z		2.0 mm .078 Inch	1.4 mm .015 Inch

Vacuum micromanipulator

Inserts for 3000ESD housing

Suction needles

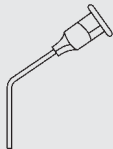
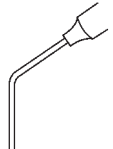
- Stainless-steel suction needle.
- Bent 45°.
- For working with 3200 or 3232 adapter.

Model		Outside diameter	Inside diameter
3303		0.30 mm .011 Inch	0.16 mm .006 Inch
3305Z		0.50 mm .020 Inch	0.25 mm .019 Inch
3310Z		1.0 mm .039 Inch	0.65 mm .025 Inch

Suction cups

- Silicone suction cup.
- For working with 3200 or 3232 adapter.

Model		Diameter
2052E		4.5 mm .177 Inch

Inserts for 3000ESD housing

Accessories

Model	Description
3715Z	Diaphragm pump 230 V, 5 l/min, max. vacuum -250 mbar
3008ESD	Tube, flexible, 1.8 m/70.866 Inch, ESD-safe
3717	Filter for tube 3008ESD
3740	Table holder for 3000ESD (without accessories)

Vacuum kit



- Complete accessories for easy pick-up and immediate set-down of components or silicon wafers.
- Set for laboratory work.
- In an ESD-safe plastic case.

Model	Description
3000KCESD	Vacuum kit
	contents:
	3000ESD Handle
	3200 Adapter, rotatable through 360°
	3231 Adapter fix
	3305Z, 3310Z, 3315 Suction needles
	2052E Suction cup, dia. 4.5 mm / .177 Inch
	KDS 260L Suction cup, dia. 9.5 mm / .374 Inch
	3740 Table holder
	3715Z Diaphragm pump 230 V
	3008ESD Tube, flexible
	3717 Filter
	102ACA SMD tweezers, 115 mm / 4.527 Inch, with bent tips and blunted edges. For vertical working with small components. Stainless steel, non-reflecting surface, non-magnetic.