

REV.	DATE	REVISE CONTENT

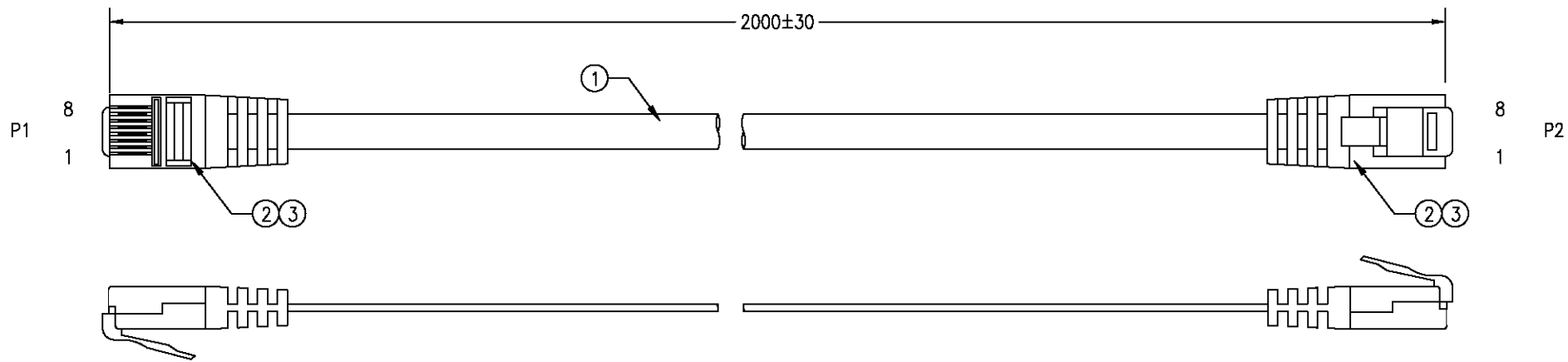

PACKING METHOD:

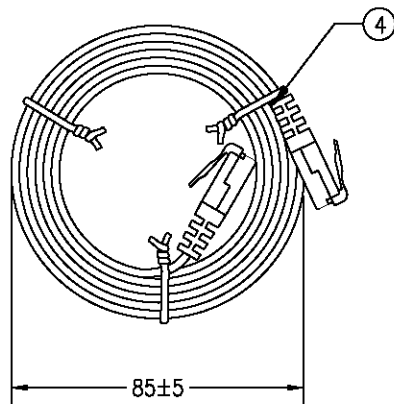

WIRE CONNECTION:

P1		P2
1	WHITE	1
2	ORANGE	2
3	WHITE	3
6	GREEN	6
4	BLUE	4
5	WHITE	5
7	WHITE	7
8	BROWN	8

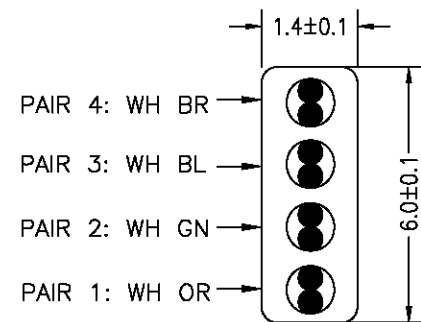

BILL OF MATERIAL

NO.	PART NO.	MAT. NAME	DESCRIPTION	Q'TY
4		MINI TIE	L=70mm.WHITE COLOR.	1 PCS
3		OVERMOLD	50P PVC.	5.0 g
2		PLUG	8P8C PLUG.GOLD PLATED 15u'.	2 PCS
1		CABLE	32AWG*4P (7/0.08BC).INSULATION:PE.JACKET:60P PVC. OD=1.4*6.0mm.L=2020+20/-0mm.	1 PC

CUSTOMER	Maxxtro®	PAGE	1 OF 1	CPN:	103902/103909/103916/103923	DWG.	TYJ	DATE	10/03/19
DWG NO.	00-0003	REV.	A0	PN:	1000003015XX	CHK.		DATE	
						APP.		DATE	