

REV.	DATE	FILE No.
1.0	2011-5-3	AC5-3M

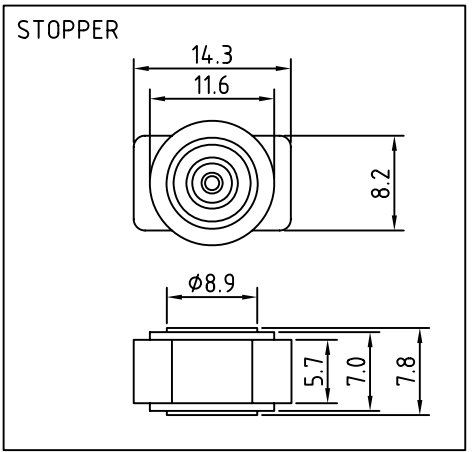

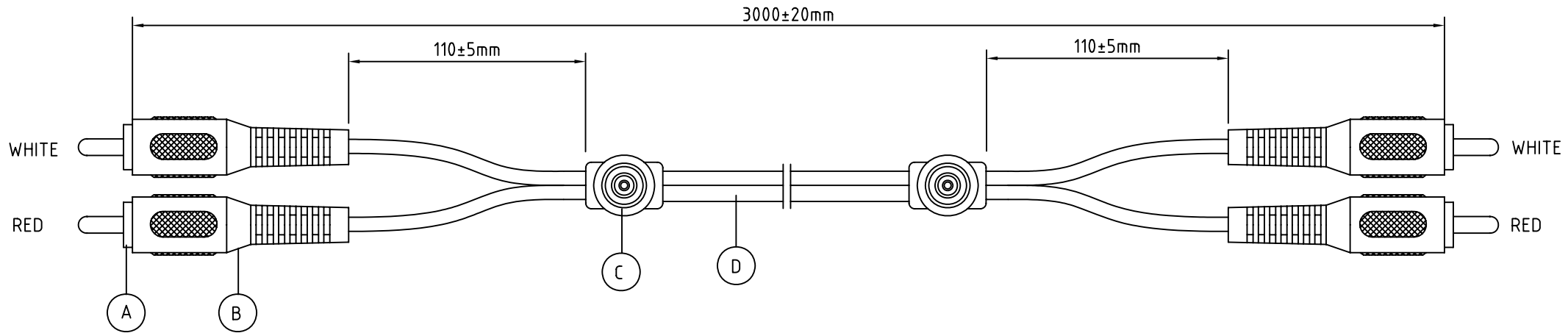

WIRING DIAGRAM

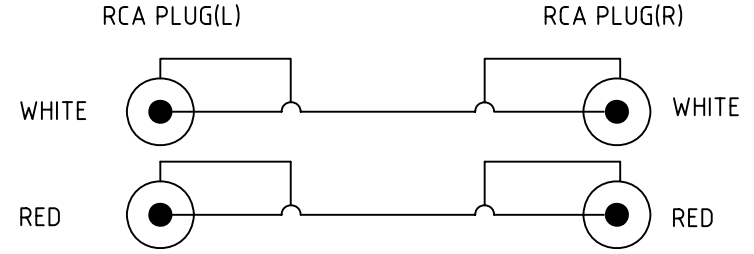

SPECIFICATION:

ITEM	PART NAME	MATERIAL	COLOR	QTY.
A	Y/A023 RCA PLUG	BRASS	NICKEL	4
B	MODEL TY-122 TYPE	PVC	WT/RD	4
C	STOPPER MODEL TY-046 TYPE	PVC	BLACK	2
D	CABLE(0.12/10+0.12/12)X2F #2.6X5.2MM	PVC	BLACK	3M

NOTE:ALL MATERIALS ARE COMPLIANCE TO "RoHS"

CUSTOMER: JESS LINK		Maxxtro®
CUST. P/N:105068		
S/O:	S/N:	PART No.: AC5-3M/BK
DRAWING No.	AC-005-33	PART NAME: 2XRCA PLUG TO 2XRCA PLUG
DRAWN BY	Lingqi MENG	UNLESS OTHERWISE SPECIFIED, ALL DIMENSIONS ARE IN MM. TOLERANCE:DECIMAL .X ±0.1 .XX ±0.05 ANGLE ±1/2°
CHECKED BY	Zhongjiao/Baifa	
APPROVED BY	Chenhan	
		 
		SHEET 1 OF 1
		SCALE NO