



AC-DC SWITCHING ADAPTER SPECIFICATION

MODEL .	MW3K10HT	ISSUE DATE	2009-12-05
CUSTOMER		REF. NO.	

INPUT

INPUT VOLTAGE	100 to 240 Vac
INPUT FREQUENCY	50 to 60 Hz
NO LOAD POWER CONSUMPTION	< 0.3 W
INPUT FULL LOAD CURRENT(at 120 Vac)	0.25 A

OUTPUT

LIGHT LOAD OUTPUT VOLTAGE	3.0/4.5/5.0/6.0/7.5/9.0/12.0V dc $\pm 10\%$
FULL LOAD OUTPUT VOLTAGE	3.0/4.5/5.0/6.0/7.5/9.0/12.0V dc $\pm 10\%$
MIN LOAD OUTPUT CURRENT	0 A
MAX LOAD OUTPUT CURRENT	1.0 A
LINE REGULATION	0.5 % Input 90 to 264 Vac output loaded at full load
SETUP,RISE,HOLD UPTIME	200ms,30ms,17ms/115Vac; 200ms,20ms,80ms/230Vac

OVERALL PERFORMANCE

TOTAL OUTPUT POWER	12 W Max
EFFICIENCY	COMPLIED with EUP

PROTECTION

<input checked="" type="checkbox"/> OVER CURRENT PROTECTION	<input checked="" type="checkbox"/> SHORT CIRCUIT PROTECTION
<input checked="" type="checkbox"/> OVER VOLTAGE PROTECTION	<input checked="" type="checkbox"/> L.P.S (Limits for power source)
<input checked="" type="checkbox"/> OVER POWER PROTECTION	<input type="checkbox"/> OTHER

HI-POT

INPUT TO OUTPUT	3000 Vac 5 mA 50/60 Hz
INPUT TO CASE	3000 Vac 5 mA 50/60 Hz
OUTPUT TO CASE	1500 Vac 5 mA 50/60 Hz
ISOLATION RESISTANCE	100 M Ohms I/P-O/P I/P/Enclosure
APPLIANCE	CLASS I <input type="checkbox"/> II <input checked="" type="checkbox"/> III <input type="checkbox"/>

ENVIRONMENTAL

OPERATING TEMPERATURE	0 °C to 25 °C
STORGE TEMPERATURE	-20 °C to 50 °C
OPERATING HUMIDITY	20%-85% RH. NON-CONDENSING
STORGE HUMIDITY	10%-90% RH. NON-CONDENSING

SAFFTY STANDARDS

SAFETY STANDARDS	GS
EMC STANDARDS	CE

RELIABILITY

MTBF	50000 Hours min
BURN-IN	8 Hours 25°C,full load,220Vac,50Hz

AC-DC SWITCHING ADAPTER SPECIFICATION

MODEL NO.	MW3K10HT	ISSUE DATE	2009-12-05
CUSTOMER		REF. NO.	

MECHANICAL SPECIFICATION

DIMENSION	78.5 mm(L)* 42.5mm(W)* 40mm(H)
WEIGHT	185g MAX exclude packing
INPUT CORD	
INPUT PLUG	HTU HTUK HTSAA HTAF
OUTPUT CORD	
OUTPUT PLUG	
OUTPUT CONNECTOR	

APPEARANCE & DIMENSIONS



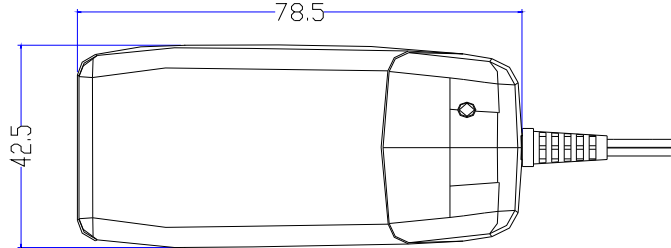
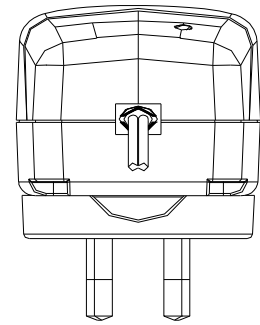
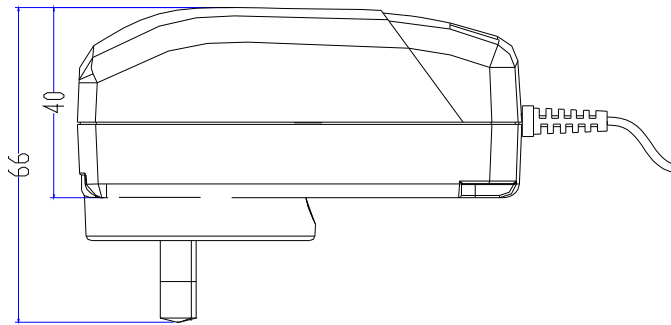
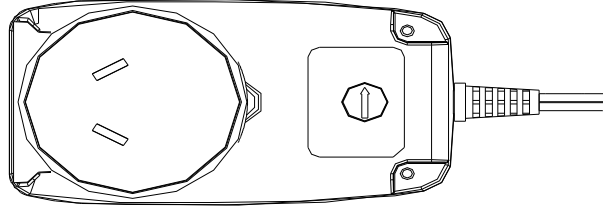
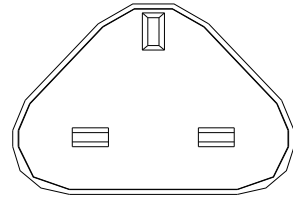
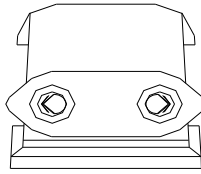
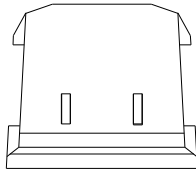

APPROVE:

AUDITING:

CONNER: