



MAK 5100 grau/grey

Industrial Connectors:Connectors for audio, video and data:Miniature multipole connectors:with locking screw:Straight sockets

Product description

Type	MAK 5100 grau/grey
Order No.	930 960-517
Type of contact	female
Description	socket with locking screw; solder joint
Housing Color	grey
Number of contacts	5
Conductor size	$\leq 0.34 \text{ mm}^2$

Drawing

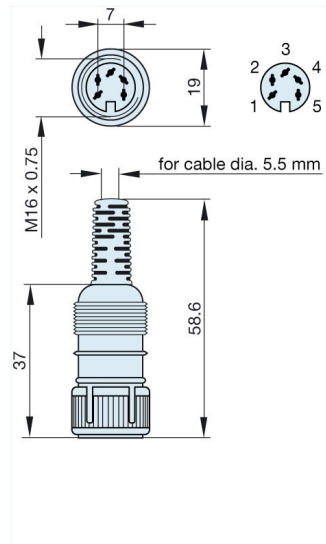

Technical data

LF output "Phone"	EN 60 130-09
Rated current	$\leq 4 \text{ A}$
Rated voltage	UC 34 V
Cable diameter	5.5 mm
Type of termination	solder

Material

Contact material (socket)	brass
Contact surface material	tin plated
Contact bearer material	PA 66/UL standard 94V-2
Housing material	PE

Environmental conditions

Protection class (IEC 60529)	IP 30
Temperature range	-20 °C to +60 °C

Scope of delivery and accessories

Packaging	retail package, polyethylene bag
-----------	----------------------------------