



Film Capacitors

Metallized Polypropylene Film Capacitors (MKP)

Series/Type: B32656S

Date: December 2012

Snubber (wound)

Typical applications

- IGBT
- Snubbing

Climatic

- Max. operating temperature: 110 °C
- Climatic category (IEC 60068-1): 55/100/56

Construction

- Dielectric: polypropylene (PP)
- Wound capacitor technology with internal series connection
- Plastic case (UL 94 V-0)
- Epoxy resin sealing (UL 94 V-0)

Features

- High pulse strength and high contact reliability
- Very low inductance
- RoHS-compatible
- Halogen-free capacitors available on request

Terminals

- Strap terminals, tinned copper or brass (max. torque 10 Nm)

Marking

Manufacturer's logo, ordering code, style (MKP) rated capacitance (coded), cap. tolerance (code letter), rated DC voltage, date of manufacture (coded)

Delivery mode

Bulk (untaped)

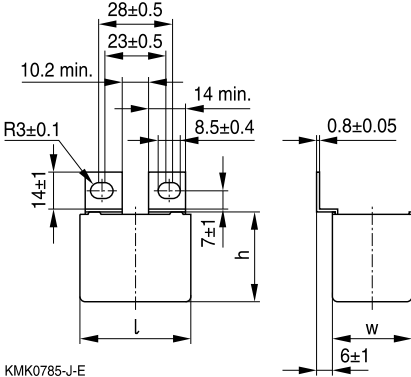
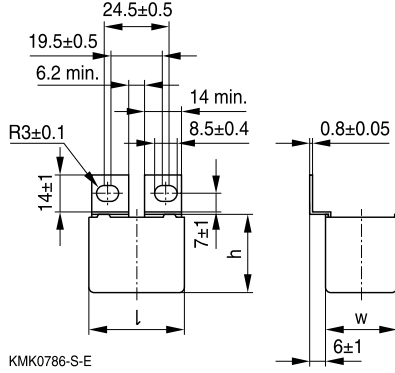
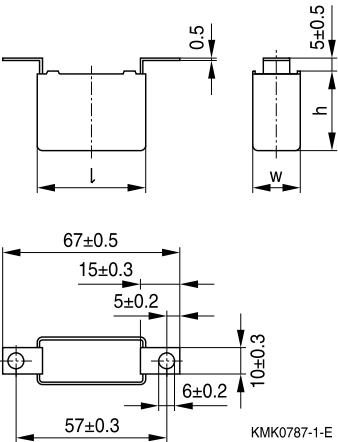
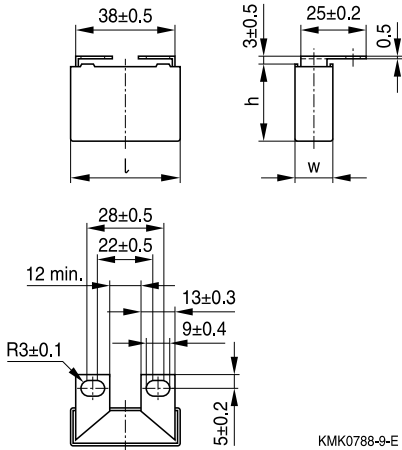
Dimensional drawings
T1 (code no. 561)

T2 (code no. 562)

T3 (code no. 563)

T4 (code no. 564)



B32656S

Snubber (wound)

Dimensional drawings (continued)

T5 (code no. 565)

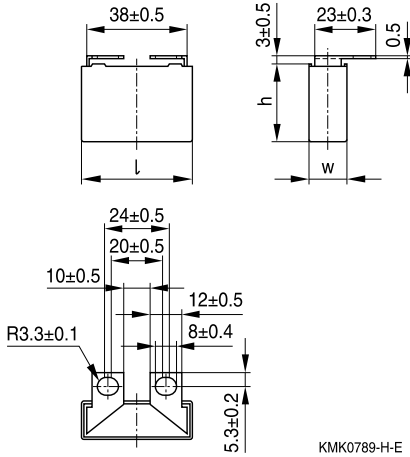

T6 (code no. 566)

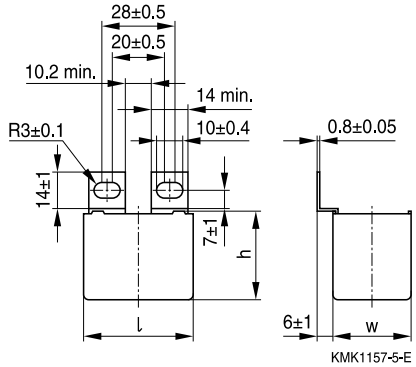

T7 (code no. 577)

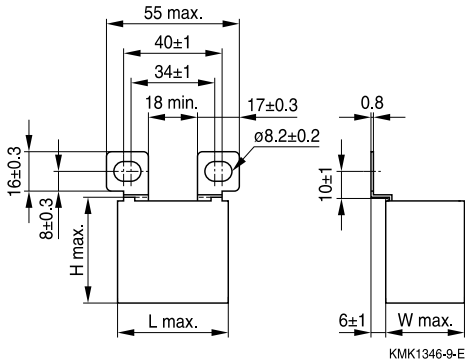

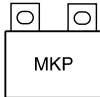
Overview of available types

Type	B32656S				
V_R (V DC)	850	1000	1250	1600	2000
V_{RMS} (V AC)	450	480	500	750	800
C_R (nF)					
47					
68					
100					
120					
150					
220					
270					
330					
390					
470					
560					
680					
820					
1000					
1200					
1500					
1800					
2200					
2700					
3300					

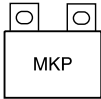
B32656S
Snubber (wound)
Electrical specifications, ordering codes and packing units

V_R	V_{RMS} $f \leq 1 \text{ kHz}$	C_R	Max. dimensions $w \times h \times l$ mm	I_{RMS} 100 kHz A	ESR 100 kHz $m\Omega$	Ordering code (composition see below)	Ter- minal	pcs./ MOQ
V DC	V AC	nF						
850	450	220	12.0 × 22.5 × 42.0	5	10.0	B32656S8224+563	T3	224
		220	12.0 × 22.5 × 42.0	5	10.0	B32656S8224+564	T4	384
		270	12.0 × 22.5 × 42.0	6	9.0	B32656S8274+563	T3	224
		270	12.0 × 22.5 × 42.0	6	9.0	B32656S8274+564	T4	384
		330	12.0 × 22.5 × 42.0	6	9.0	B32656S8334+563	T3	224
		330	12.0 × 22.5 × 42.0	6	9.0	B32656S8334+564	T4	384
		390	12.0 × 22.5 × 42.0	7	8.0	B32656S8394+563	T3	224
		390	12.0 × 22.5 × 42.0	7	8.0	B32656S8394+564	T4	384
		470	12.0 × 22.5 × 42.0	8	8.0	B32656S8474+563	T3	224
		470	12.0 × 22.5 × 42.0	8	8.0	B32656S8474+564	T4	384
		560	14.0 × 25.0 × 42.0	8	7.0	B32656S8564+563	T3	168
		560	14.0 × 25.0 × 42.0	8	7.0	B32656S8564+564	T4	288
		560	14.0 × 25.0 × 42.0	8	7.0	B32656S8564+565	T5	288
		680	16.0 × 28.5 × 42.0	9	6.0	B32656S8684+561	T1	192
		680	16.0 × 28.5 × 42.0	9	6.0	B32656S8684+562	T2	192
		680	16.0 × 28.5 × 42.0	9	6.0	B32656S8684+563	T3	144
		680	16.0 × 28.5 × 42.0	9	6.0	B32656S8684+564	T4	192
		680	16.0 × 28.5 × 42.0	9	6.0	B32656S8684+565	T5	192
		680	16.0 × 28.5 × 42.0	9	6.0	B32656S8684+566	T6	192
		680	16.0 × 28.5 × 42.0	9	6.0	B32656S8684+577	T7	180
		820	16.0 × 28.5 × 42.0	10	6.0	B32656S8824+561	T1	192
		820	16.0 × 28.5 × 42.0	10	6.0	B32656S8824+562	T2	192
		820	16.0 × 28.5 × 42.0	10	6.0	B32656S8824+563	T3	144
		820	16.0 × 28.5 × 42.0	10	6.0	B32656S8824+564	T4	192
		820	16.0 × 28.5 × 42.0	10	6.0	B32656S8824+565	T5	192
		820	16.0 × 28.5 × 42.0	10	6.0	B32656S8824+566	T6	192
		820	16.0 × 28.5 × 42.0	10	6.0	B32656S8824+577	T7	180

MOQ = Minimum Order Quantity, consisting of 4 packing units.

Further E series and intermediate capacitance values on request.

Composition of ordering code

+ = Capacitance tolerance code:

K = ±10%

J = ±5%

Electrical specifications, ordering codes and packing units

V_R	V_{RMS} $f \leq 1 \text{ kHz}$	C_R	Max. dimensions $w \times h \times l$ mm	I_{RMS} 100 kHz A	ESR 100 kHz m Ω	Ordering code (composition see below)	Ter- minal	pcs./ MOQ
V DC	V AC	nF						
850	450	1000	18.0 × 32.5 × 42.0	11	6.0	B32656S8105+561	T1	168
		1000	18.0 × 32.5 × 42.0	11	6.0	B32656S8105+562	T2	168
		1000	18.0 × 32.5 × 42.0	11	6.0	B32656S8105+563	T3	144
		1000	18.0 × 32.5 × 42.0	11	6.0	B32656S8105+564	T4	128
		1000	18.0 × 32.5 × 42.0	11	6.0	B32656S8105+565	T5	128
		1000	18.0 × 32.5 × 42.0	11	6.0	B32656S8105+566	T6	168
		1000	18.0 × 32.5 × 42.0	11	6.0	B32656S8105+577	T7	156
		1200	18.0 × 32.5 × 42.0	11	5.0	B32656S8125+561	T1	168
		1200	18.0 × 32.5 × 42.0	11	5.0	B32656S8125+562	T2	168
		1200	18.0 × 32.5 × 42.0	11	5.0	B32656S8125+563	T3	144
		1200	18.0 × 32.5 × 42.0	11	5.0	B32656S8125+564	T4	128
		1200	18.0 × 32.5 × 42.0	11	5.0	B32656S8125+565	T5	128
		1200	18.0 × 32.5 × 42.0	11	5.0	B32656S8125+566	T6	168
		1200	18.0 × 32.5 × 42.0	11	5.0	B32656S8125+577	T7	156
		1500	31.0 × 26.5 × 43.6	13	5.0	B32656S8155+561	T1	128
		1500	31.0 × 26.5 × 43.6	13	5.0	B32656S8155+562	T2	128
		1500	31.0 × 26.5 × 43.6	13	5.0	B32656S8155+563	T3	72
		1500	31.0 × 26.5 × 43.6	13	5.0	B32656S8155+566	T6	128
		1500	31.0 × 26.5 × 43.6	13	5.0	B32656S8155+577	T7	84
		1800	28.0 × 37.0 × 42.0	15	4.5	B32656S8185+561	T1	108
		1800	28.0 × 37.0 × 42.0	15	4.5	B32656S8185+562	T2	108
		1800	28.0 × 37.0 × 42.0	15	4.5	B32656S8185+563	T3	96
		1800	28.0 × 37.0 × 42.0	15	4.5	B32656S8185+566	T6	108
		1800	28.0 × 37.0 × 42.0	15	4.5	B32656S8185+577	T7	96
		2200	30.0 × 45.0 × 42.0	17	3.5	B32656S8225+561	T1	48
		2200	30.0 × 45.0 × 42.0	17	3.5	B32656S8225+562	T2	48
		2200	30.0 × 45.0 × 42.0	17	3.5	B32656S8225+563	T3	96
		2200	30.0 × 45.0 × 42.0	17	3.5	B32656S8225+566	T6	48
		2200	30.0 × 45.0 × 42.0	17	3.5	B32656S8225+577	T7	96

MOQ = Minimum Order Quantity, consisting of 4 packing units.

Further E series and intermediate capacitance values on request.

Composition of ordering code

+ = Capacitance tolerance code:

K = $\pm 10\%$

J = $\pm 5\%$

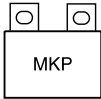
B32656S
Snubber (wound)
Electrical specifications, ordering codes and packing units

V_R	V_{RMS} $f \leq 1 \text{ kHz}$	C_R	Max. dimensions $w \times h \times l$ mm	I_{RMS} 100 kHz A	ESR 100 kHz $m\Omega$	Ordering code (composition see below)	Ter- minal	pcs./ MOQ		
V DC	V AC	nF								
850	450	2700	30.0 × 45.0 × 42.0	20	3.0	B32656S8275+561	T1	48		
		2700	30.0 × 45.0 × 42.0	20	3.0	B32656S8275+562	T2	48		
		2700	30.0 × 45.0 × 42.0	20	3.0	B32656S8275+563	T3	96		
		2700	30.0 × 45.0 × 42.0	20	3.0	B32656S8275+566	T6	48		
		2700	30.0 × 45.0 × 42.0	20	3.0	B32656S8275+577	T7	96		
		3300	33.0 × 48.0 × 43.0	23	2.5	B32656S8335+561	T1	84		
		3300	33.0 × 48.0 × 43.0	23	2.5	B32656S8335+562	T2	84		
		3300	33.0 × 48.0 × 43.0	23	2.5	B32656S8335+563	T3	64		
		3300	33.0 × 48.0 × 43.0	23	2.5	B32656S8335+566	T6	84		
		3300	33.0 × 48.0 × 43.0	23	2.5	B32656S8335+577	T7	84		
		1000	480	220	12.0 × 22.5 × 42.0	6	10.0	B32656S0224+563	T3	224
				220	12.0 × 22.5 × 42.0	6	10.0	B32656S0224+564	T4	384
270	12.0 × 22.5 × 42.0			7	9.0	B32656S0274+563	T3	224		
270	12.0 × 22.5 × 42.0			7	9.0	B32656S0274+564	T4	384		
330	14.0 × 25.0 × 42.0			7	9.0	B32656S0334+563	T3	168		
330	14.0 × 25.0 × 42.0			7	9.0	B32656S0334+564	T4	288		
330	14.0 × 25.0 × 42.0			7	9.0	B32656S0334+565	T5	288		
390	14.0 × 25.0 × 42.0			8	8.0	B32656S0394+563	T3	168		
390	14.0 × 25.0 × 42.0			8	8.0	B32656S0394+564	T4	288		
390	14.0 × 25.0 × 42.0			8	8.0	B32656S0394+565	T5	288		
470	14.0 × 25.0 × 42.0			9	8.0	B32656S0474+563	T3	168		
470	14.0 × 25.0 × 42.0			9	8.0	B32656S0474+564	T4	288		
470	14.0 × 25.0 × 42.0			9	8.0	B32656S0474+565	T5	288		
560	16.0 × 28.5 × 42.0			9	7.0	B32656S0564+561	T1	192		
560	16.0 × 28.5 × 42.0			9	7.0	B32656S0564+562	T2	192		
560	16.0 × 28.5 × 42.0			9	7.0	B32656S0564+563	T3	144		
560	16.0 × 28.5 × 42.0			9	7.0	B32656S0564+564	T4	192		
560	16.0 × 28.5 × 42.0			9	7.0	B32656S0564+565	T5	192		
560	16.0 × 28.5 × 42.0			9	7.0	B32656S0564+566	T6	192		
560	16.0 × 28.5 × 42.0			9	7.0	B32656S0564+577	T7	180		

MOQ = Minimum Order Quantity, consisting of 4 packing units.

Further E series and intermediate capacitance values on request.

Composition of ordering code

+ = Capacitance tolerance code:

K = ±10%

J = ±5%

Electrical specifications, ordering codes and packing units

V_R	V_{RMS} $f \leq 1 \text{ kHz}$	C_R	Max. dimensions $w \times h \times l$ mm	I_{RMS} 100 kHz A	ESR 100 kHz $m\Omega$	Ordering code (composition see below)	Ter- minal	pcs./ MOQ
V DC	V AC	nF						
1000	480	680	$16.0 \times 28.5 \times 42.0$	10	6.0	B32656S0684+561	T1	192
		680	$16.0 \times 28.5 \times 42.0$	10	6.0	B32656S0684+562	T2	192
		680	$16.0 \times 28.5 \times 42.0$	10	6.0	B32656S0684+563	T3	144
		680	$16.0 \times 28.5 \times 42.0$	10	6.0	B32656S0684+564	T4	192
		680	$16.0 \times 28.5 \times 42.0$	10	6.0	B32656S0684+565	T5	192
		680	$16.0 \times 28.5 \times 42.0$	10	6.0	B32656S0684+566	T6	192
		680	$16.0 \times 28.5 \times 42.0$	10	6.0	B32656S0684+577	T7	180
		820	$18.0 \times 32.5 \times 42.0$	11	6.0	B32656S0824+561	T1	168
		820	$18.0 \times 32.5 \times 42.0$	11	6.0	B32656S0824+562	T2	168
		820	$18.0 \times 32.5 \times 42.0$	11	6.0	B32656S0824+563	T3	144
		820	$18.0 \times 32.5 \times 42.0$	11	6.0	B32656S0824+564	T4	128
		820	$18.0 \times 32.5 \times 42.0$	11	6.0	B32656S0824+565	T5	128
		820	$18.0 \times 32.5 \times 42.0$	11	6.0	B32656S0824+566	T6	168
		820	$18.0 \times 32.5 \times 42.0$	11	6.0	B32656S0824+577	T7	156
	1000	$20.0 \times 39.5 \times 42.0$	12	6.0	B32656S0105+561	T1	96	
	1000	$20.0 \times 39.5 \times 42.0$	12	6.0	B32656S0105+562	T2	96	
	1000	$20.0 \times 39.5 \times 42.0$	12	6.0	B32656S0105+563	T3	104	
	1000	$20.0 \times 39.5 \times 42.0$	12	6.0	B32656S0105+564	T4	96	
	1000	$20.0 \times 39.5 \times 42.0$	12	6.0	B32656S0105+565	T5	96	
	1000	$20.0 \times 39.5 \times 42.0$	12	6.0	B32656S0105+566	T6	96	
	1000	$20.0 \times 39.5 \times 42.0$	12	6.0	B32656S0105+577	T7	144	
	1200	$20.0 \times 39.5 \times 42.0$	13	5.0	B32656S0125+561	T1	96	
	1200	$20.0 \times 39.5 \times 42.0$	13	5.0	B32656S0125+562	T2	96	
	1200	$20.0 \times 39.5 \times 42.0$	13	5.0	B32656S0125+563	T3	104	
	1200	$20.0 \times 39.5 \times 42.0$	13	5.0	B32656S0125+564	T4	96	
	1200	$20.0 \times 39.5 \times 42.0$	13	5.0	B32656S0125+565	T5	96	
	1200	$20.0 \times 39.5 \times 42.0$	13	5.0	B32656S0125+566	T6	96	
	1200	$20.0 \times 39.5 \times 42.0$	13	5.0	B32656S0125+577	T7	144	

MOQ = Minimum Order Quantity, consisting of 4 packing units.

Further E series and intermediate capacitance values on request.

Composition of ordering code

+ = Capacitance tolerance code:

K = $\pm 10\%$

J = $\pm 5\%$

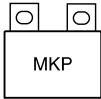
B32656S
Snubber (wound)
Electrical specifications, ordering codes and packing units

V_R	V_{RMS} $f \leq 1 \text{ kHz}$	C_R	Max. dimensions $w \times h \times l$ mm	I_{RMS} 100 kHz A	ESR 100 kHz m Ω	Ordering code (composition see below)	Ter- minal	pcs./ MOQ
V DC	V AC	nF						
1000	480	1500	30.0 × 45.0 × 42.0	15	5.0	B32656S0155+561	T1	48
		1500	30.0 × 45.0 × 42.0	15	5.0	B32656S0155+562	T2	48
		1500	30.0 × 45.0 × 42.0	15	5.0	B32656S0155+563	T3	96
		1500	30.0 × 45.0 × 42.0	15	5.0	B32656S0155+566	T6	48
		1500	30.0 × 45.0 × 42.0	15	5.0	B32656S0155+577	T7	96
		1800	30.0 × 45.0 × 42.0	16	4.5	B32656S0185+561	T1	48
		1800	30.0 × 45.0 × 42.0	16	4.5	B32656S0185+562	T2	48
		1800	30.0 × 45.0 × 42.0	16	4.5	B32656S0185+563	T3	96
		1800	30.0 × 45.0 × 42.0	16	4.5	B32656S0185+566	T6	48
		1800	30.0 × 45.0 × 42.0	16	4.5	B32656S0185+577	T7	96
		2200	30.0 × 45.0 × 42.0	19	3.5	B32656S0225+561	T1	48
		2200	30.0 × 45.0 × 42.0	19	3.5	B32656S0225+562	T2	48
		2200	30.0 × 45.0 × 42.0	19	3.5	B32656S0225+563	T3	96
		2200	30.0 × 45.0 × 42.0	19	3.5	B32656S0225+566	T6	48
		2200	30.0 × 45.0 × 42.0	19	3.5	B32656S0225+577	T7	96
		2700	33.0 × 48.0 × 43.0	23	2.5	B32656S0275+561	T1	84
		2700	33.0 × 48.0 × 43.0	23	2.5	B32656S0275+562	T2	84
		2700	33.0 × 48.0 × 43.0	23	2.5	B32656S0275+563	T3	64
		2700	33.0 × 48.0 × 43.0	23	2.5	B32656S0275+566	T6	84
		2700	33.0 × 48.0 × 43.0	23	2.5	B32656S0275+577	T7	84
1250	500	120	12.0 × 22.5 × 42.0	5	15.0	B32656S7124+563	T3	224
		120	12.0 × 22.5 × 42.0	5	15.0	B32656S7124+564	T4	384
		150	12.0 × 22.5 × 42.0	6	15.0	B32656S7154+563	T3	224
		150	12.0 × 22.5 × 42.0	6	15.0	B32656S7154+564	T4	384
		220	14.0 × 25.0 × 42.0	8	10.0	B32656S7224+563	T3	168
		220	14.0 × 25.0 × 42.0	8	10.0	B32656S7224+564	T4	288
		220	14.0 × 25.0 × 42.0	8	10.0	B32656S7224+565	T5	288
		270	14.0 × 25.0 × 42.0	8	9.0	B32656S7274+563	T3	168
		270	14.0 × 25.0 × 42.0	8	9.0	B32656S7274+564	T4	288
		270	14.0 × 25.0 × 42.0	8	9.0	B32656S7274+565	T5	288

MOQ = Minimum Order Quantity, consisting of 4 packing units.

Further E series and intermediate capacitance values on request.

Composition of ordering code

+ = Capacitance tolerance code:

K = ±10%

J = ±5%

Electrical specifications, ordering codes and packing units

V_R	V_{RMS} $f \leq 1 \text{ kHz}$	C_R	Max. dimensions $w \times h \times l$ mm	I_{RMS} 100 kHz A	ESR 100 kHz $m\Omega$	Ordering code (composition see below)	Ter- minal	pcs./ MOQ
V DC	V AC	nF						
1250	500	330	16.0 × 28.5 × 42.0	8	9.0	B32656S7334+561	T1	192
		330	16.0 × 28.5 × 42.0	8	9.0	B32656S7334+562	T2	192
		330	16.0 × 28.5 × 42.0	8	9.0	B32656S7334+563	T3	144
		330	16.0 × 28.5 × 42.0	8	9.0	B32656S7334+564	T4	192
		330	16.0 × 28.5 × 42.0	8	9.0	B32656S7334+565	T5	192
		330	16.0 × 28.5 × 42.0	8	9.0	B32656S7334+566	T6	192
		330	16.0 × 28.5 × 42.0	8	9.0	B32656S7334+577	T7	180
		390	18.0 × 32.5 × 42.0	9	8.0	B32656S7394+561	T1	168
		390	18.0 × 32.5 × 42.0	9	8.0	B32656S7394+562	T2	168
		390	18.0 × 32.5 × 42.0	9	8.0	B32656S7394+563	T3	144
		390	18.0 × 32.5 × 42.0	9	8.0	B32656S7394+564	T4	128
		390	18.0 × 32.5 × 42.0	9	8.0	B32656S7394+565	T5	128
		390	18.0 × 32.5 × 42.0	9	8.0	B32656S7394+566	T6	168
		390	18.0 × 32.5 × 42.0	9	8.0	B32656S7394+577	T7	156
		470	18.0 × 32.5 × 42.0	9	8.0	B32656S7474+561	T1	168
		470	18.0 × 32.5 × 42.0	9	8.0	B32656S7474+562	T2	168
		470	18.0 × 32.5 × 42.0	9	8.0	B32656S7474+563	T3	144
		470	18.0 × 32.5 × 42.0	9	8.0	B32656S7474+564	T4	128
		470	18.0 × 32.5 × 42.0	9	8.0	B32656S7474+565	T5	128
		470	18.0 × 32.5 × 42.0	9	8.0	B32656S7474+566	T6	168
		470	18.0 × 32.5 × 42.0	9	8.0	B32656S7474+577	T7	156
		560	20.0 × 39.5 × 42.0	10	7.0	B32656S7564+561	T1	96
		560	20.0 × 39.5 × 42.0	10	7.0	B32656S7564+562	T2	96
		560	20.0 × 39.5 × 42.0	10	7.0	B32656S7564+563	T3	104
		560	20.0 × 39.5 × 42.0	10	7.0	B32656S7564+564	T4	96
		560	20.0 × 39.5 × 42.0	10	7.0	B32656S7564+565	T5	96
		560	20.0 × 39.5 × 42.0	10	7.0	B32656S7564+566	T6	96
		560	20.0 × 39.5 × 42.0	10	7.0	B32656S7564+577	T7	144

MOQ = Minimum Order Quantity, consisting of 4 packing units.

Further E series and intermediate capacitance values on request.

Composition of ordering code

+ = Capacitance tolerance code:

K = ±10%

J = ±5%

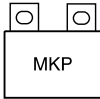
B32656S
Snubber (wound)
Electrical specifications, ordering codes and packing units

V_R	V_{RMS} $f \leq 1 \text{ kHz}$	C_R	Max. dimensions $w \times h \times l$ mm	I_{RMS} 100 kHz A	ESR 100 kHz $m\Omega$	Ordering code (composition see below)	Ter- minal	pcs./ MOQ
V DC	V AC	nF						
1250	500	680	20.0 × 39.5 × 42.0	12	6.0	B32656S7684+561	T1	96
		680	20.0 × 39.5 × 42.0	12	6.0	B32656S7684+562	T2	96
		680	20.0 × 39.5 × 42.0	12	6.0	B32656S7684+563	T3	104
		680	20.0 × 39.5 × 42.0	12	6.0	B32656S7684+564	T4	96
		680	20.0 × 39.5 × 42.0	12	6.0	B32656S7684+565	T5	96
		680	20.0 × 39.5 × 42.0	12	6.0	B32656S7684+566	T6	96
		680	20.0 × 39.5 × 42.0	12	6.0	B32656S7684+577	T7	144
		820	28.0 × 37.0 × 42.0	13	6.0	B32656S7824+561	T1	108
		820	28.0 × 37.0 × 42.0	13	6.0	B32656S7824+562	T2	108
		820	28.0 × 37.0 × 42.0	13	6.0	B32656S7824+563	T3	72
		820	28.0 × 37.0 × 42.0	13	6.0	B32656S7824+566	T6	108
		820	28.0 × 37.0 × 42.0	13	6.0	B32656S7824+577	T7	96
		1000	28.0 × 37.0 × 42.0	15	6.0	B32656S7105+561	T1	108
		1000	28.0 × 37.0 × 42.0	15	6.0	B32656S7105+562	T2	108
		1000	28.0 × 37.0 × 42.0	15	6.0	B32656S7105+563	T3	72
		1000	28.0 × 37.0 × 42.0	15	6.0	B32656S7105+566	T6	108
		1000	28.0 × 37.0 × 42.0	15	6.0	B32656S7105+577	T7	96
		1200	30.0 × 45.0 × 42.0	16	5.0	B32656S7125+561	T1	48
		1200	30.0 × 45.0 × 42.0	16	5.0	B32656S7125+562	T2	48
		1200	30.0 × 45.0 × 42.0	16	5.0	B32656S7125+563	T3	72
		1200	30.0 × 45.0 × 42.0	16	5.0	B32656S7125+566	T6	48
		1200	30.0 × 45.0 × 42.0	16	5.0	B32656S7125+577	T7	96
		1500	30.0 × 45.0 × 42.0	18	4.0	B32656S7155+561	T1	48
		1500	30.0 × 45.0 × 42.0	18	4.0	B32656S7155+562	T2	48
		1500	30.0 × 45.0 × 42.0	18	4.0	B32656S7155+563	T3	72
		1500	30.0 × 45.0 × 42.0	18	4.0	B32656S7155+566	T6	48
		1500	30.0 × 45.0 × 42.0	18	4.0	B32656S7155+577	T7	96
		1800	33.0 × 48.0 × 43.0	22	3.0	B32656S7185+561	T1	84
		1800	33.0 × 48.0 × 43.0	22	3.0	B32656S7185+562	T2	84
		1800	33.0 × 48.0 × 43.0	22	3.0	B32656S7185+563	T3	64
		1800	33.0 × 48.0 × 43.0	22	3.0	B32656S7185+566	T6	84
		1800	33.0 × 48.0 × 43.0	22	3.0	B32656S7185+577	T7	84

MOQ = Minimum Order Quantity, consisting of 4 packing units.

Further E series and intermediate capacitance values on request.

Composition of ordering code

+ = Capacitance tolerance code:

K = ±10%

J = ±5%

Electrical specifications, ordering codes and packing units

V_R	V_{RMS} $f \leq 1 \text{ kHz}$	C_R	Max. dimensions $w \times h \times l$ mm	I_{RMS} 100 kHz A	ESR 100 kHz $m\Omega$	Ordering code (composition see below)	Ter- minal	pcs./ MOQ
V DC	V AC	nF						
1600	750	68	12.0 × 22.5 × 42.0	5	25.0	B32656S1683+563	T3	224
		68	12.0 × 22.5 × 42.0	5	25.0	B32656S1683+564	T4	384
		100	12.0 × 22.5 × 42.0	6	20.0	B32656S1104+563	T3	224
		100	12.0 × 22.5 × 42.0	6	20.0	B32656S1104+564	T4	384
		120	14.0 × 25.0 × 42.0	6	15.0	B32656S1124+563	T3	168
		120	14.0 × 25.0 × 42.0	6	15.0	B32656S1124+564	T4	288
		120	14.0 × 25.0 × 42.0	6	15.0	B32656S1124+565	T5	288
		150	14.0 × 25.0 × 42.0	7	15.0	B32656S1154+563	T3	168
		150	14.0 × 25.0 × 42.0	7	15.0	B32656S1154+564	T4	288
		150	14.0 × 25.0 × 42.0	7	15.0	B32656S1154+565	T5	288
		220	16.0 × 28.5 × 42.0	9	10.0	B32656S1224+561	T1	192
		220	16.0 × 28.5 × 42.0	9	10.0	B32656S1224+562	T2	192
		220	16.0 × 28.5 × 42.0	9	10.0	B32656S1224+563	T3	144
		220	16.0 × 28.5 × 42.0	9	10.0	B32656S1224+564	T4	192
		220	16.0 × 28.5 × 42.0	9	10.0	B32656S1224+565	T5	192
		220	16.0 × 28.5 × 42.0	9	10.0	B32656S1224+566	T6	192
		220	16.0 × 28.5 × 42.0	9	10.0	B32656S1224+577	T7	180
		270	18.0 × 32.5 × 42.0	10	9.0	B32656S1274+561	T1	168
		270	18.0 × 32.5 × 42.0	10	9.0	B32656S1274+562	T2	168
		270	18.0 × 32.5 × 42.0	10	9.0	B32656S1274+563	T3	144
		270	18.0 × 32.5 × 42.0	10	9.0	B32656S1274+564	T4	128
		270	18.0 × 32.5 × 42.0	10	9.0	B32656S1274+565	T5	128
		270	18.0 × 32.5 × 42.0	10	9.0	B32656S1274+566	T6	168
		270	18.0 × 32.5 × 42.0	10	9.0	B32656S1274+577	T7	156
		330	20.0 × 39.5 × 42.0	12	9.0	B32656S1334+561	T1	96
		330	20.0 × 39.5 × 42.0	12	9.0	B32656S1334+562	T2	96
		330	20.0 × 39.5 × 42.0	12	9.0	B32656S1334+563	T3	104
		330	20.0 × 39.5 × 42.0	12	9.0	B32656S1334+564	T4	96
		330	20.0 × 39.5 × 42.0	12	9.0	B32656S1334+565	T5	96
		330	20.0 × 39.5 × 42.0	12	9.0	B32656S1334+566	T6	96
		330	20.0 × 39.5 × 42.0	12	9.0	B32656S1334+577	T7	144

MOQ = Minimum Order Quantity, consisting of 4 packing units.

Further E series and intermediate capacitance values on request.

Composition of ordering code

+ = Capacitance tolerance code:

K = ±10%

J = ±5%

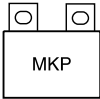
B32656S
Snubber (wound)
Electrical specifications, ordering codes and packing units

V_R	V_{RMS} $f \leq 1 \text{ kHz}$	C_R	Max. dimensions $w \times h \times l$ mm	I_{RMS} 100 kHz A	ESR 100 kHz $m\Omega$	Ordering code (composition see below)	Ter- minal	pcs./ MOQ
V DC	V AC	nF						
1600	750	390	28.0 × 37.0 × 42.0	13	8.0	B32656S1394+561	T1	108
		390	28.0 × 37.0 × 42.0	13	8.0	B32656S1394+562	T2	108
		390	28.0 × 37.0 × 42.0	13	8.0	B32656S1394+563	T3	72
		390	28.0 × 37.0 × 42.0	13	8.0	B32656S1394+566	T6	108
		390	28.0 × 37.0 × 42.0	13	8.0	B32656S1394+577	T7	96
		470	28.0 × 37.0 × 42.0	14	8.0	B32656S1474+561	T1	108
		470	28.0 × 37.0 × 42.0	14	8.0	B32656S1474+562	T2	108
		470	28.0 × 37.0 × 42.0	14	8.0	B32656S1474+563	T3	72
		470	28.0 × 37.0 × 42.0	14	8.0	B32656S1474+566	T6	108
		470	28.0 × 37.0 × 42.0	14	8.0	B32656S1474+577	T7	96
		560	30.0 × 45.0 × 42.0	15	7.0	B32656S1564+561	T1	48
		560	30.0 × 45.0 × 42.0	15	7.0	B32656S1564+562	T2	48
		560	30.0 × 45.0 × 42.0	15	7.0	B32656S1564+563	T3	72
		560	30.0 × 45.0 × 42.0	15	7.0	B32656S1564+566	T6	48
		560	30.0 × 45.0 × 42.0	15	7.0	B32656S1564+577	T7	96
		680	30.0 × 45.0 × 42.0	17	6.0	B32656S1684+561	T1	48
		680	30.0 × 45.0 × 42.0	17	6.0	B32656S1684+562	T2	48
		680	30.0 × 45.0 × 42.0	17	6.0	B32656S1684+563	T3	72
		680	30.0 × 45.0 × 42.0	17	6.0	B32656S1684+566	T6	48
		680	30.0 × 45.0 × 42.0	17	6.0	B32656S1684+577	T7	96
		820	33.0 × 48.0 × 43.0	20	4.5	B32656S1824+561	T1	84
		820	33.0 × 48.0 × 43.0	20	4.5	B32656S1824+562	T2	84
		820	33.0 × 48.0 × 43.0	20	4.5	B32656S1824+563	T3	64
		820	33.0 × 48.0 × 43.0	20	4.5	B32656S1824+566	T6	84
		820	33.0 × 48.0 × 43.0	20	4.5	B32656S1824+577	T7	84

MOQ = Minimum Order Quantity, consisting of 4 packing units.

Further E series and intermediate capacitance values on request.

Composition of ordering code

+ = Capacitance tolerance code:

K = ±10%

J = ±5%

Electrical specifications, ordering codes and packing units

V_R	V_{RMS} $f \leq 1 \text{ kHz}$	C_R	Max. dimensions $w \times h \times l$	I_{RMS} 100 kHz	ESR 100 kHz	Ordering code (composition see below)	Ter- minal	pcs./ MOQ
V DC	V AC	nF	mm	A	m Ω			
2000	800	47	12.0 × 22.5 × 42.0	5	35.0	B32656S2473+563	T3	224
		47	12.0 × 22.5 × 42.0	5	35.0	B32656S2473+564	T4	384
		68	14.0 × 25.0 × 42.0	6	25.0	B32656S2683+563	T3	192
		68	14.0 × 25.0 × 42.0	6	25.0	B32656S2683+564	T4	288
		68	14.0 × 25.0 × 42.0	6	25.0	B32656S2683+565	T5	288
		100	14.0 × 25.0 × 42.0	7	20.0	B32656S2104+563	T3	192
		100	14.0 × 25.0 × 42.0	7	20.0	B32656S2104+564	T4	288
		100	14.0 × 25.0 × 42.0	7	20.0	B32656S2104+565	T5	288
		120	16.0 × 28.5 × 42.0	7	15.0	B32656S2124+561	T1	192
		120	16.0 × 28.5 × 42.0	7	15.0	B32656S2124+562	T2	192
		120	16.0 × 28.5 × 42.0	7	15.0	B32656S2124+563	T3	144
		120	16.0 × 28.5 × 42.0	7	15.0	B32656S2124+564	T4	192
		120	16.0 × 28.5 × 42.0	7	15.0	B32656S2124+565	T5	192
		120	16.0 × 28.5 × 42.0	7	15.0	B32656S2124+566	T6	192
		120	16.0 × 28.5 × 42.0	7	15.0	B32656S2124+577	T7	180
		150	18.0 × 32.5 × 42.0	9	15.0	B32656S2154+561	T1	168
		150	18.0 × 32.5 × 42.0	9	15.0	B32656S2154+562	T2	168
		150	18.0 × 32.5 × 42.0	9	15.0	B32656S2154+563	T3	160
		150	18.0 × 32.5 × 42.0	9	15.0	B32656S2154+564	T4	192
		150	18.0 × 32.5 × 42.0	9	15.0	B32656S2154+565	T5	192
		150	18.0 × 32.5 × 42.0	9	15.0	B32656S2154+566	T6	168
		150	18.0 × 32.5 × 42.0	9	15.0	B32656S2154+577	T7	156
		220	20.0 × 39.5 × 42.0	12	10.0	B32656S2224+561	T1	96
		220	20.0 × 39.5 × 42.0	12	10.0	B32656S2224+562	T2	96
		220	20.0 × 39.5 × 42.0	12	10.0	B32656S2224+563	T3	104
		220	20.0 × 39.5 × 42.0	12	10.0	B32656S2224+564	T4	96
		220	20.0 × 39.5 × 42.0	12	10.0	B32656S2224+565	T5	96
		220	20.0 × 39.5 × 42.0	12	10.0	B32656S2224+566	T6	96
		220	20.0 × 39.5 × 42.0	12	10.0	B32656S2224+577	T7	144

MOQ = Minimum Order Quantity, consisting of 4 packing units.

Further E series and intermediate capacitance values on request.

Composition of ordering code

+ = Capacitance tolerance code:

K = $\pm 10\%$

J = $\pm 5\%$

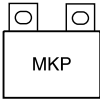
B32656S
Snubber (wound)
Electrical specifications, ordering codes and packing units

V_R	V_{RMS} $f \leq 1 \text{ kHz}$	C_R	Max. dimensions $w \times h \times l$ mm	I_{RMS} 100 kHz A	ESR 100 kHz $m\Omega$	Ordering code (composition see below)	Ter- minal	pcs./ MOQ
V DC	V AC	nF						
2000	800	270	28.0 × 37.0 × 42.0	13	9.0	B32656S2274+561	T1	108
		270	28.0 × 37.0 × 42.0	13	9.0	B32656S2274+562	T2	108
		270	28.0 × 37.0 × 42.0	13	9.0	B32656S2274+563	T3	72
		270	28.0 × 37.0 × 42.0	13	9.0	B32656S2274+566	T6	108
		270	28.0 × 37.0 × 42.0	13	9.0	B32656S2274+577	T7	96
		330	28.0 × 37.0 × 42.0	14	9.0	B32656S2334+561	T1	108
		330	28.0 × 37.0 × 42.0	14	9.0	B32656S2334+562	T2	108
		330	28.0 × 37.0 × 42.0	14	9.0	B32656S2334+563	T3	72
		330	28.0 × 37.0 × 42.0	14	9.0	B32656S2334+566	T6	108
		330	28.0 × 37.0 × 42.0	14	9.0	B32656S2334+577	T7	96
		390	30.0 × 45.0 × 42.0	15	8.0	B32656S2394+561	T1	48
		390	30.0 × 45.0 × 42.0	15	8.0	B32656S2394+562	T2	48
		390	30.0 × 45.0 × 42.0	15	8.0	B32656S2394+563	T3	72
		390	30.0 × 45.0 × 42.0	15	8.0	B32656S2394+566	T6	48
		390	30.0 × 45.0 × 42.0	15	8.0	B32656S2394+577	T7	96
		470	30.0 × 45.0 × 42.0	17	8.0	B32656S2474+561	T1	48
		470	30.0 × 45.0 × 42.0	17	8.0	B32656S2474+562	T2	48
		470	30.0 × 45.0 × 42.0	17	8.0	B32656S2474+563	T3	72
		470	30.0 × 45.0 × 42.0	17	8.0	B32656S2474+566	T6	48
		470	30.0 × 45.0 × 42.0	17	8.0	B32656S2474+577	T7	96
		560	33.0 × 48.0 × 43.0	20	6.5	B32656S2564+561	T1	84
		560	33.0 × 48.0 × 43.0	20	6.5	B32656S2564+562	T2	84
		560	33.0 × 48.0 × 43.0	20	6.5	B32656S2564+563	T3	64
		560	33.0 × 48.0 × 43.0	20	6.5	B32656S2564+566	T6	84
		560	33.0 × 48.0 × 43.0	20	6.5	B32656S2564+577	T7	84

MOQ = Minimum Order Quantity, consisting of 4 packing units.

Further E series and intermediate capacitance values on request.

Composition of ordering code

+ = Capacitance tolerance code:

K = ±10%

J = ±5%

Technical data

Operating temperature range	Max. operating temperature $T_{op,max}$			+110 °C
	Upper category temperature T_{max}			+100 °C
	Lower category temperature T_{min}			-55 °C
	Rated temperature T_R			+85 °C
Dissipation factor $\tan \delta$ (in 10^{-3}) at 20 °C (upper limit values)	at	$C_R \leq 0.1 \mu F$	$0.1 \mu F < C_R \leq 1 \mu F$	$C_R > 1 \mu F$
	1 kHz	–	0.5	0.5
	10 kHz	–	0.8	1.5
	100 kHz	5.0	–	–
Insulation resistance R_{ins} or time constant $\tau = C_R \cdot R_{ins}$ at 20 °C, rel. humidity $\leq 65\%$ (minimum as-delivered values)	$C_R \leq 0.33 \mu F$		$C_R > 0.33 \mu F$	
	100 G Ω		30000 s	
DC test voltage	$1.6 \cdot V_R$, 2 s			
Category voltage V_C (continuous operation with V_{DC} or V_{AC} at $f \leq 1$ kHz)	T_A (°C)	DC voltage derating		AC voltage derating
	$T_A \leq 85$ $85 < T_A \leq 100$	$V_C = V_R$ $V_C = V_R \cdot (165 - T_A) / 80$		$V_{C,RMS} = V_{RMS}$ $V_{C,RMS} = V_{RMS} \cdot (165 - T_A) / 80$
Operating voltage V_{op} for short operating periods (V_{DC} or V_{AC} at $f \leq 1$ kHz)	T_A (°C)	DC voltage (max. hours)		AC voltage (max. hours)
	$T_A \leq 85$ $85 < T_A \leq 100$	$V_{op} = 1.25 \cdot V_C$ (2000 h) $V_{op} = 1.25 \cdot V_C$ (1000 h)		$V_{op} = 1.0 \cdot V_{C,RMS}$ (2000 h) $V_{op} = 1.0 \cdot V_{C,RMS}$ (1000 h)
Damp heat test Limit values after damp heat test	56 days/40 °C/93% relative humidity			
	Capacitance change $ \Delta C/C $		$\leq 3\%$	
	Dissipation factor change $\Delta \tan \delta$		$\leq 0.5 \cdot 10^{-3}$ (at 1 kHz) $\leq 1.0 \cdot 10^{-3}$ (at 10 kHz)	
	Insulation resistance R_{ins} or time constant $\tau = C_R \cdot R_{ins}$		$\geq 50\%$ of minimum as-delivered values	
Reliability: Failure rate λ Service life t_{SL}	1 fit ($\leq 1 \cdot 10^{-9}/h$) at $0.5 \cdot V_R$, 40 °C 200 000 h at $1.0 \cdot V_R$, 85 °C For conversion to other operating conditions and temperatures, refer to chapter "Quality, 2 Reliability".			
Failure criteria: Total failure Failure due to variation of parameters	Short circuit or open circuit			
	Capacitance change $ \Delta C/C $		$> 10\%$	
	Dissipation factor $\tan \delta$		$> 4 \cdot$ upper limit value	
	Insulation resistance R_{ins} or time constant $\tau = C_R \cdot R_{ins}$		< 1500 M Ω ($C_R \leq 0.33 \mu F$) < 500 s ($C_R > 0.33 \mu F$)	



B32656S

Snubber (wound)

Pulse handling capability

"dV/dt" represents the maximum permissible voltage change per unit of time for non-sinusoidal voltages, expressed in V/μs.

"k₀" represents the maximum permissible pulse characteristic of the waveform applied to the capacitor, expressed in V²/μs.

Note:

The values of dV/dt and k₀ provided below must not be exceeded in order to avoid damaging the capacitor.

dV/dt and k₀ values

V _R (V DC)	V _{RMS} (V AC)	dV/dt in V/μs	k ₀ in V ² /μs
850	450	400	680 000
1000	480	450	900 000
1250	500	500	1 250 000
1600	750	600	1 920 000
2000	800	700	2 800 000

Impedance Z versus frequency f

(typical values)

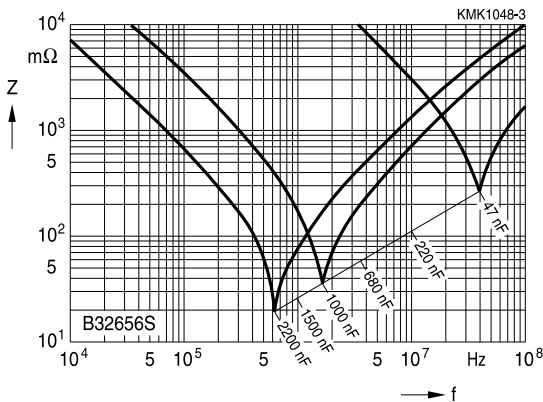

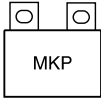
Permissible AC voltage V_{RMS} versus frequency f (for sinusoidal waveforms, $T_A \leq 90^\circ C$)

 For $T_A > 90^\circ C$, please refer to "General technical information", section 3.2.3.

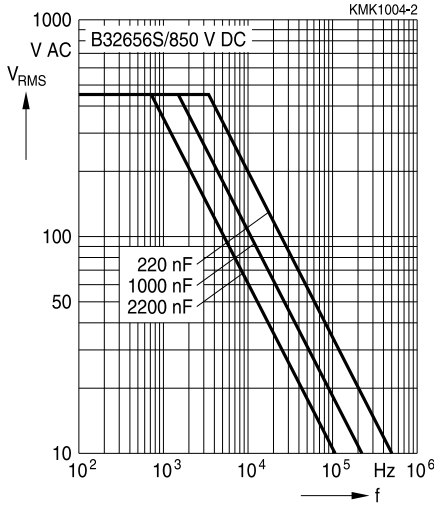
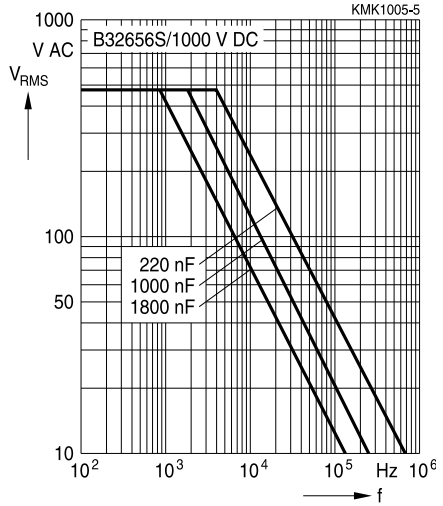
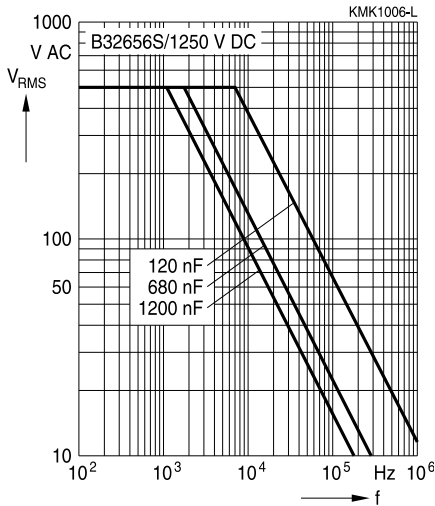
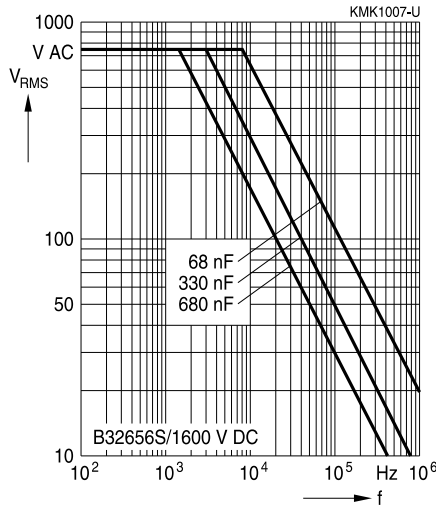
850 V DC/450 V AC

1000 V DC/480 V AC

1250 V DC/500 V AC

1600 V DC/750 V AC



B32656S

Snubber (wound)

Permissible AC voltage V_{RMS} versus frequency f (for sinusoidal waveforms, $T_A \leq 90^\circ C$)

For $T_A > 90^\circ C$, please refer to "General technical information", section 3.2.3.

2000 V DC/800 V AC

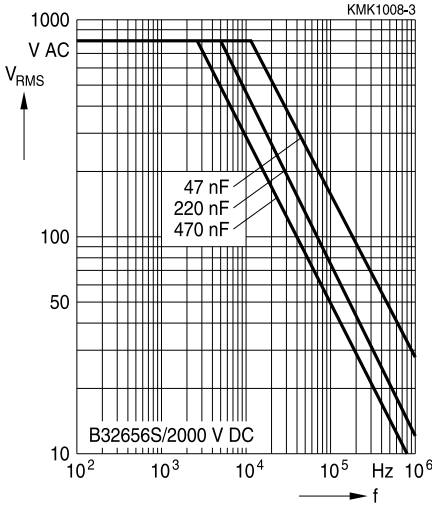

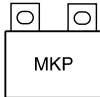

Mounting guidelines

1 Soldering

1.1 Solderability of leads

The solderability of terminal leads is tested to IEC 60068-2-20, test Ta, method 1.

Before a solderability test is carried out, terminals are subjected to accelerated ageing (to IEC 60068-2-2, test Ba: 4 h exposure to dry heat at 155 °C). Since the ageing temperature is far higher than the upper category temperature of the capacitors, the terminal wires should be cut off from the capacitor before the ageing procedure to prevent the solderability being impaired by the products of any capacitor decomposition that might occur.

Solder bath temperature	235 ±5 °C
Soldering time	2.0 ±0.5 s
Immersion depth	2.0 +0/-0.5 mm from capacitor body or seating plane
Evaluation criteria:	
Visual inspection	Wetting of wire surface by new solder ≥90%, free-flowing solder

1.2 Resistance to soldering heat

Resistance to soldering heat is tested to IEC 60068-2-20, test Tb, method 1A.

Conditions:

Series	Solder bath temperature	Soldering time
MKT boxed (except 2.5 × 6.5 × 7.2 mm) coated uncoated (lead spacing > 10 mm)	260 ±5 °C	10 ±1 s
MFP MKP (lead spacing > 7.5 mm)		
MKT boxed (case 2.5 × 6.5 × 7.2 mm)		5 ±1 s
MKP (lead spacing ≤ 7.5 mm)		< 4 s
MKT uncoated (lead spacing ≤ 10 mm) insulated (B32559)		recommended soldering profile for MKT uncoated (lead spacing ≤ 10 mm) and insulated (B32559)

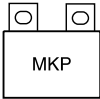

B32656S

Snubber (wound)

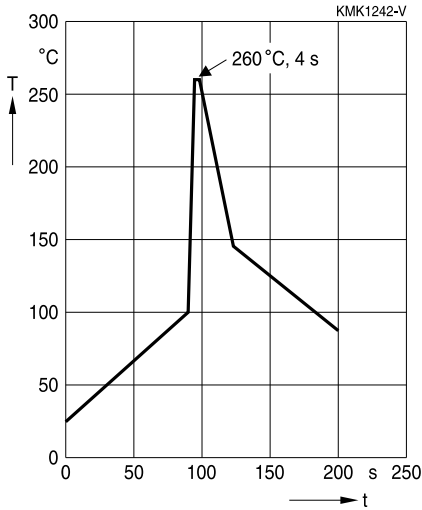

Immersion depth	2.0 +0/−0.5 mm from capacitor body or seating plane
Shield	Heat-absorbing board, (1.5 ±0.5) mm thick, between capacitor body and liquid solder
Evaluation criteria:	
Visual inspection	No visible damage
$\Delta C/C_0$	2% for MKT/MKP/MFP 5% for EMI suppression capacitors
$\tan \delta$	As specified in sectional specification

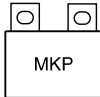

1.3 General notes on soldering

Permissible heat exposure loads on film capacitors are primarily characterized by the upper category temperature T_{max} . Long exposure to temperatures above this type-related temperature limit can lead to changes in the plastic dielectric and thus change irreversibly a capacitor's electrical characteristics. For short exposures (as in practical soldering processes) the heat load (and thus the possible effects on a capacitor) will also depend on other factors like:

- Pre-heating temperature and time
- Forced cooling immediately after soldering
- Terminal characteristics:
 - diameter, length, thermal resistance, special configurations (e.g. crimping)
- Height of capacitor above solder bath
- Shadowing by neighboring components
- Additional heating due to heat dissipation by neighboring components
- Use of solder-resist coatings

The overheating associated with some of these factors can usually be reduced by suitable countermeasures. For example, if a pre-heating step cannot be avoided, an additional or reinforced cooling process may possibly have to be included.

EPCOS recommends the following conditions:

- Pre-heating with a maximum temperature of 110 °C
- Temperature inside the capacitor should not exceed the following limits:
 - MKP/MFP 110 °C
 - MKT 160 °C
- When SMD components are used together with leaded ones, the leaded film capacitors should not pass into the SMD adhesive curing oven. The leaded components should be assembled after the SMD curing step.
- Leaded film capacitors are not suitable for reflow soldering.

Uncoated capacitors

For uncoated MKT capacitors with lead spacings ≤ 10 mm (B32560/B32561) the following measures are recommended:

- pre-heating to not more than 110 °C in the preheater phase
- rapid cooling after soldering

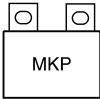
B32656S
Snubber (wound)

Cautions and warnings

- Do not exceed the upper category temperature (UCT).
- Do not apply any mechanical stress to the capacitor terminals.
- Avoid any compressive, tensile or flexural stress.
- Do not move the capacitor after it has been soldered to the PC board.
- Do not pick up the PC board by the soldered capacitor.
- Do not place the capacitor on a PC board whose PTH hole spacing differs from the specified lead spacing.
- Do not exceed the specified time or temperature limits during soldering.
- Avoid external energy inputs, such as fire or electricity.
- Avoid overload of the capacitors.

The table below summarizes the safety instructions that must always be observed. A detailed description can be found in the relevant sections of the chapters "General technical information" and "Mounting guidelines".

Topic	Safety information	Reference chapter "General technical information"
Storage conditions	Make sure that capacitors are stored within the specified range of time, temperature and humidity conditions.	4.5 "Storage conditions"
Flammability	Avoid external energy, such as fire or electricity (passive flammability), avoid overload of the capacitors (active flammability) and consider the flammability of materials.	5.3 "Flammability"
Resistance to vibration	Do not exceed the tested ability to withstand vibration. The capacitors are tested to IEC 60068-2-6. EPCOS offers film capacitors specially designed for operation under more severe vibration regimes such as those found in automotive applications. Consult our catalog "Film Capacitors for Automotive Electronics".	5.2 "Resistance to vibration"

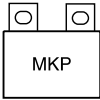

Topic	Safety information	Reference chapter "Mounting guidelines"
Soldering	Do not exceed the specified time or temperature limits during soldering.	1 "Soldering"
Cleaning	Use only suitable solvents for cleaning capacitors.	2 "Cleaning"
Embedding of capacitors in finished assemblies	When embedding finished circuit assemblies in plastic resins, chemical and thermal influences must be taken into account. Caution: Consult us first, if you also wish to embed other uncoated component types!	3 "Embedding of capacitors in finished assemblies"

B32656S
Snubber (wound)
Symbols and terms

Symbol	English	German
α	Heat transfer coefficient	Wärmeübergangszahl
α_C	Temperature coefficient of capacitance	Temperaturkoeffizient der Kapazität
A	Capacitor surface area	Kondensatoroberfläche
β_C	Humidity coefficient of capacitance	Feuchtekoeffizient der Kapazität
C	Capacitance	Kapazität
C_R	Rated capacitance	Nennkapazität
ΔC	Absolute capacitance change	Absolute Kapazitätsänderung
$\Delta C/C$	Relative capacitance change (relative deviation of actual value)	Relative Kapazitätsänderung (relative Abweichung vom Ist-Wert)
$\Delta C/C_R$	Capacitance tolerance (relative deviation from rated capacitance)	Kapazitätstoleranz (relative Abweichung vom Nennwert)
dt	Time differential	Differentielle Zeit
Δt	Time interval	Zeitintervall
ΔT	Absolute temperature change (self-heating)	Absolute Temperaturänderung (Selbsterwärmung)
$\Delta \tan \delta$	Absolute change of dissipation factor	Absolute Änderung des Verlustfaktors
ΔV	Absolute voltage change	Absolute Spannungsänderung
dV/dt	Time differential of voltage function (rate of voltage rise)	Differentielle Spannungsänderung (Spannungsflankensteilheit)
$\Delta V/\Delta t$	Voltage change per time interval	Spannungsänderung pro Zeitintervall
E	Activation energy for diffusion	Aktivierungsenergie zur Diffusion
ESL	Self-inductance	Eigeninduktivität
ESR	Equivalent series resistance	Ersatz-Serienwiderstand
f	Frequency	Frequenz
f_1	Frequency limit for reducing permissible AC voltage due to thermal limits	Grenzfrequenz für thermisch bedingte Reduzierung der zulässigen Wechselspannung
f_2	Frequency limit for reducing permissible AC voltage due to current limit	Grenzfrequenz für strombedingte Reduzierung der zulässigen Wechselspannung
f_r	Resonant frequency	Resonanzfrequenz
F_D	Thermal acceleration factor for diffusion	Therm. Beschleunigungsfaktor zur Diffusion
F_T	Derating factor	Deratingfaktor
i	Current (peak)	Stromspitze
I_C	Category current (max. continuous current)	Kategoriestrom (max. Dauerstrom)

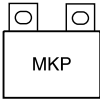

Symbol	English	German
I_{RMS}	(Sinusoidal) alternating current, root-mean-square value	(Sinusförmiger) Wechselstrom
i_z	Capacitance drift	Inkonstanz der Kapazität
k_0	Pulse characteristic	Impuls Kennwert
L_S	Series inductance	Serieninduktivität
λ	Failure rate	Ausfallrate
λ_0	Constant failure rate during useful service life	Konstante Ausfallrate in der Nutzungsphase
λ_{test}	Failure rate, determined by tests	Experimentell ermittelte Ausfallrate
P_{diss}	Dissipated power	Abgegebene Verlustleistung
P_{gen}	Generated power	Erzeugte Verlustleistung
Q	Heat energy	Wärmeenergie
ρ	Density of water vapor in air	Dichte von Wasserdampf in Luft
R	Universal molar constant for gases	Allg. Molarkonstante für Gas
R	Ohmic resistance of discharge circuit	Ohmscher Widerstand des Entladekreises
R_i	Internal resistance	Innenwiderstand
R_{ins}	Insulation resistance	Isolationswiderstand
R_P	Parallel resistance	Parallelwiderstand
R_S	Series resistance	Serienwiderstand
S	severity (humidity test)	Schärfegrad (Feuchtest)
t	Time	Zeit
T	Temperature	Temperatur
τ	Time constant	Zeitkonstante
$\tan \delta$	Dissipation factor	Verlustfaktor
$\tan \delta_D$	Dielectric component of dissipation factor	Dielektrischer Anteil des Verlustfaktors
$\tan \delta_P$	Parallel component of dissipation factor	Parallelanteil des Verlustfaktors
$\tan \delta_S$	Series component of dissipation factor	Serienanteil des Verlustfaktors
T_A	Ambient temperature	Umgebungstemperatur
T_{max}	Upper category temperature	Obere Kategorietemperatur
T_{min}	Lower category temperature	Untere Kategorietemperatur
t_{OL}	Operating life at operating temperature and voltage	Betriebszeit bei Betriebstemperatur und -spannung
T_{op}	Operating temperature	Betriebstemperatur
T_R	Rated temperature	Nenntemperatur
T_{ref}	Reference temperature	Referenztemperatur
t_{SL}	Reference service life	Referenz-Lebensdauer
V_{AC}	AC voltage	Wechselspannung

B32656S
Snubber (wound)

Symbol	English	German
V_C	Category voltage	Kategorie ­ spannung
$V_{C,RMS}$	Category AC voltage	(Sinusförmige) Kategorie-Wechselspannung
V_{CD}	Corona-discharge onset voltage	Teilentlade-Einsatzspannung
V_{ch}	Charging voltage	Ladespannung
V_{DC}	DC voltage	Gleichspannung
V_{FB}	Fly-back capacitor voltage	Spannung (Flyback)
V_i	Input voltage	Eingangsspannung
V_o	Output voltage	Ausgangssspannung
V_{op}	Operating voltage	Betriebsspannung
V_p	Peak pulse voltage	Impuls-Spitzen ­ spannung
V_{pp}	Peak-to-peak voltage Impedance	Spannungshub
V_R	Rated voltage	Nennspannung
\hat{V}_R	Amplitude of rated AC voltage	Amplitude der Nenn-Wechselspannung
V_{RMS}	(Sinusoidal) alternating voltage, root-mean-square value	(Sinusförmige) Wechselspannung
V_{SC}	S-correction voltage	Spannung bei Anwendung "S-correction"
V_{sn}	Snubber capacitor voltage	Spannung bei Anwendung "Beschaltung"
Z	Impedance	Scheinwiderstand
e	Lead spacing	Rastermaß

Important notes

The following applies to all products named in this publication:

1. Some parts of this publication contain **statements about the suitability of our products for certain areas of application**. These statements are based on our knowledge of typical requirements that are often placed on our products in the areas of application concerned. We nevertheless expressly point out **that such statements cannot be regarded as binding statements about the suitability of our products for a particular customer application**. As a rule, EPCOS is either unfamiliar with individual customer applications or less familiar with them than the customers themselves. For these reasons, it is always ultimately incumbent on the customer to check and decide whether an EPCOS product with the properties described in the product specification is suitable for use in a particular customer application.
2. We also point out that **in individual cases, a malfunction of electronic components or failure before the end of their usual service life cannot be completely ruled out in the current state of the art, even if they are operated as specified**. In customer applications requiring a very high level of operational safety and especially in customer applications in which the malfunction or failure of an electronic component could endanger human life or health (e.g. in accident prevention or lifesaving systems), it must therefore be ensured by means of suitable design of the customer application or other action taken by the customer (e.g. installation of protective circuitry or redundancy) that no injury or damage is sustained by third parties in the event of malfunction or failure of an electronic component.
3. **The warnings, cautions and product-specific notes must be observed.**
4. In order to satisfy certain technical requirements, **some of the products described in this publication may contain substances subject to restrictions in certain jurisdictions (e.g. because they are classed as hazardous)**. Useful information on this will be found in our Material Data Sheets on the Internet (www.epcos.com/material). Should you have any more detailed questions, please contact our sales offices.
5. We constantly strive to improve our products. Consequently, **the products described in this publication may change from time to time**. The same is true of the corresponding product specifications. Please check therefore to what extent product descriptions and specifications contained in this publication are still applicable before or when you place an order. We also **reserve the right to discontinue production and delivery of products**. Consequently, we cannot guarantee that all products named in this publication will always be available. The aforementioned does not apply in the case of individual agreements deviating from the foregoing for customer-specific products.
6. Unless otherwise agreed in individual contracts, **all orders are subject to the current version of the "General Terms of Delivery for Products and Services in the Electrical Industry" published by the German Electrical and Electronics Industry Association (ZVEI)**.
7. The trade names EPCOS, BAOKE, Alu-X, CeraDiode, CeraLink, CSMP, CSSP, CTVS, DeltaCap, DigiSiMic, DSSP, FilterCap, FormFit, MiniBlue, MiniCell, MKD, MKK, MLSC, MotorCap, PCC, PhaseCap, PhaseCube, PhaseMod, PhiCap, SIFERRIT, SIFI, SIKOREL, SilverCap, SIMDAD, SiMic, SIMID, SineFormer, SIOV, SIP5D, SIP5K, ThermoFuse, WindCap are **trademarks registered or pending** in Europe and in other countries. Further information will be found on the Internet at www.epcos.com/trademarks.

Mouser Electronics

Authorized Distributor

Click to View Pricing, Inventory, Delivery & Lifecycle Information:

EPCOS:

[B32656S7474K561](#) [B32656S7105K561](#) [B32656S7105K562](#) [B32656S7105K563](#) [B32656S7224K563](#)
[B32656S7224K564](#) [B32656S7224K565](#) [B32656S7684K561](#) [B32656S7684K562](#) [B32656S7684K563](#)
[B32656S7684K564](#) [B32656S7684K565](#) [B32656S8155J561](#) [B32656S8225J561](#) [B32656S7474J564](#)
[B32656S7105J561](#) [B32656S2104J564](#) [B32656S2224J561](#) [B32656S2474J561](#) [B32656S8824K565](#)
[B32656S8155K561](#) [B32656S8225K561](#) [B32656S7334K565](#) [B32656S7564K561](#) [B32656S7564K562](#)
[B32656S7125K561](#) [B32656S7125K562](#) [B32656S1334K561](#) [B32656S1334K565](#) [B32656S1474K561](#)
[B32656S2104K564](#) [B32656S2224K561](#) [B32656S2334K561](#) [B32656S2474K561](#) [B32656S2474K562](#)
[B32656S1684K561](#) [B32656S1684K563](#) [B32656S1224K565](#)