

Digital Fiber Sensors E3X-DA-S

The next-generation platform for a wide range of sensing

- The industry's first Power Tuning function in a digital amplifier.
- Large, easy-to-read displays that are clear even from a distance. Seven convenient display formats.
- Stable long-term performance achieved with OMRON's APC function.
- A wide array of advanced functions for even more applications.
- The same ease-of-use as the E3X-DA-N Amplifiers.
- Environmentally friendly design.
- Improved Mobile Console.



Ordering Information

■ Amplifier Units

Amplifier Units with Cables

Item		Appearance	Functions	Model	
				NPN output	PNP output
Standard models			---	E3X-DA11-S	E3X-DA41-S
Mark-detecting models	Green LED		---	E3X-DAG11-S	E3X-DAG41-S
	Blue LED		---	E3X-DAB11-S	E3X-DAB41-S
Advanced models	Twin-output models		Area output, self-diagnosis, differential operation	E3X-DA11TW-S	E3X-DA41TW-S
	External-input models		Remote setting, counter, differential operation	E3X-DA11RM-S	E3X-DA41RM-S

Amplifier Units with Connectors

Item		Appearance	Functions	Model	
				NPN output	PNP output
Standard models			---	E3X-DA6-S	E3X-DA8-S
Mark-detecting models	Green LED		---	E3X-DAG6-S	E3X-DAG8-S
	Blue LED		---	E3X-DAB6-S	E3X-DAB8-S
Advanced models	Twin-output models		Area output, self-diagnosis, differential operation	E3X-DA6TW-S	E3X-DA8TW-S
	External-input models		Remote setting, counter, differential operation	E3X-DA6RM-S	E3X-DA8RM-S

■ Amplifier Unit Connectors (Order Separately)

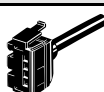
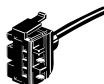
Item	Appearance	Cable length	No. of conductors	Model
Master Connector		2 m	3	E3X-CN11
			4	E3X-CN21
Slave Connector			1	E3X-CN12
			2	E3X-CN22

Combining Amplifier Units and Connectors





Amplifier Units and Connectors are sold separately. Refer to the following tables when placing an order.

Amplifier Unit			+	Applicable Connector (Order Separately)	
Model	NPN output	PNP output		Master Connector	Slave Connector
Standard models	E3X-DA6-S	E3X-DA8-S		E3X-CN11 (3-wire)	E3X-CN12 (1-wire)
Mark-detecting models	E3X-DAG6-S	E3X-DAG8-S		E3X-CN21 (4-wire)	E3X-CN22 (2-wire)
	E3X-DAB6-S	E3X-DAB8-S			
Advanced models	E3X-DA6TW-S	E3X-DA8TW-S			
	E3X-DA6RM-S	E3X-DA8RM-S			

When Using 5 Amplifier Units

Amplifier Units (5 Units)	+	1 Master Connector + 4 Slave Connectors
---------------------------	---	---

■ Mobile Console (Order Separately)

Appearance	Model	Remarks
	E3X-MC11-S (model number of set)	Mobile Console with Head, Cable, and AC adapter provided as accessories
	E3X-MC11-C1-S	Mobile Console
	E3X-MC11-H1	Head
	E39-Z12-1	Cable (1.5 m)

Note: Use the E3X-MC11-S Mobile Console for the E3X-DA-S-series Amplifier Units. Other Mobile Consoles cannot be used.

■ Accessories (Order Separately)

Mounting Bracket

Appearance	Model	Quantity
	E39-L143	1

End Plate

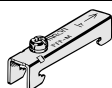
Appearance	Model	Quantity
	PFP-M	1

Specifications

■ Ratings/Characteristics

Amplifier Units

Amplifier Units with Cables

Model		Type	Standard models	Mark-detecting models		Advanced, twin-output models	Advanced, external-input models
		NPN output	E3X-DA11-S	E3X-DAG11-S	E3X-DAB11-S	E3X-DA11TW-S	E3X-DA11RM-S
Item	PNP output		E3X-DA41-S	E3X-DAG41-S	E3X-DAB41-S	E3X-DA41TW-S	E3X-DA41RM-S
Light source (wavelength)		Red LED (650 nm)		Green LED (525 nm)	Blue LED (470 nm)	Red LED (650 nm)	
Supply voltage		12 to 24 VDC ±10%, ripple (p-p) 10% max.					
Power consumption		960 mW max. (current consumption: 40 mA max. at power supply voltage of 24 VDC)				1,080 mW max. (current consumption: 45 mA max. at power supply voltage of 24 VDC)	
Control output		Load power supply voltage: 26.4 VDC; NPN/PNP open collector; load current: 50 mA max.; residual voltage: 1 V max.					
Circuit protection		Reverse polarity for power supply connection, output short-circuit					
Response time	Super-high-speed mode	NPN	48 μs for operation and 50 μs for reset			80 μs for operation and reset respectively	48 μs for operation and 50 μs for reset ¹
		PNP	53 μs for operation and 55 μs for reset				53 μs for operation and 55 μs for reset ¹
	Standard mode		1 ms for operation and reset respectively				
	High-resolution mode		4 ms for operation and reset respectively				
Sensitivity setting		Teaching or manual method					
Functions	Power tuning	Light emission power and reception gain, digital control method					
	Differential detection	---				Switchable between single edge and double edge detection mode Single edge: Can be set to 250 μs, 500 μs, 1 ms, 10 ms, or 100 ms. Double edge: Can be set to 500 μs, 1 ms, 2 ms, 20 ms, or 200 ms.	
	Timer function	Select from OFF-delay, ON-delay, or one-shot timer. 1 ms to 5 s (1 to 20 ms set in 1-ms increments, 20 to 200 ms set in 10-ms increments, 200 ms to 1 s set in 100-ms increments, and 1 to 5 s set in 1 s-increments)					
	Automatic power control (APC)	High-speed control method for emission current					
	Zero-reset	Display can be reset to zero when required (negative values can be displayed).					
	Initial reset	Settings can be returned to defaults as required.					
	Mutual interference prevention	Possible for up to 10 Units ^{2, 3}					
	Counter	---					Switchable between up counter and down counter. Set count: 0 to 9,999,999
I/O settings	---				Output setting (Select from channel 2 output, area output, or self-diagnosis.)		External input setting (Select from teaching, power tuning, zero reset, light OFF, or counter reset.)
Display	Operation indicator (orange), Power Tuning indicator (orange)				Operation indicator for channel 1 (orange), Operation indicator for channel 2 (orange)		Operation indicator (orange), Power Tuning indicator (orange)
Digital display	Select from the following: Incident level + threshold, incident level percentage + threshold, incident light peak level + no incident light bottom level, minimum incident light peak level + maximum no incident light bottom level, long bar display, incident level + peak hold, incident level + channel					Select from same displays as given at the left or a counter display.	
Display orientation	Switching between normal/reversed display is possible.						

Item	Model	Type	Standard models	Mark-detecting models		Advanced, twin-output models	Advanced, external-input models
		NPN output	E3X-DA11-S	E3X-DAG11-S	E3X-DAB11-S	E3X-DA11TW-S	E3X-DA11RM-S
		PNP output	E3X-DA41-S	E3X-DAG41-S	E3X-DAB41-S	E3X-DA41TW-S	E3X-DA41RM-S
Ambient illumination (receiver side)		Incandescent lamp: 10,000 lux max. Sunlight: 20,000 lux max.					
Ambient temperature		Operating: Groups of 1 to 2 Amplifiers: -25°C to 55°C Groups of 3 to 10 Amplifiers: -25°C to 50°C Groups of 11 to 16 Amplifiers: -25°C to 45°C (with no icing or condensation) Storage: -30°C to 70°C (with no icing or condensation)					
Ambient humidity		Operating and storage: 35% to 85% (with no condensation)					
Insulation resistance		20 MΩ min. (at 500 VDC)					
Dielectric strength		1,000 VAC at 50/60 Hz for 1 minute					
Vibration resistance (destruction)		10 to 55 Hz with a 1.5-mm double amplitude for 2 hrs each in X, Y and Z directions					
Shock resistance (destruction)		500 m/s ² , for 3 times each in X, Y and Z directions					
Enclosure rating		IEC 60529 IP50 (with Protective Cover attached)					
Connection method		Prewired cable					
Weight (packed state)		Approx. 100 g					
Materials	Case	Polybutylene terephthalate (PBT)					
	Cover	Polycarbonate (PC)					
Accessories		Instruction sheet					

*1: When counter is enabled: 80 μs for operation and reset respectively.

*2: Communications are disabled if the detection mode is selected during super-high-speed mode, and the communications functions for mutual interference prevention and the Mobile Console will not function.

*3: Mutual interference prevention can be used for only up to 6 Units if power tuning is enabled.

Amplifier Units with Connectors

(Specifications different to those for Amplifier Units with cables)

Item	Model	Type	Standard models	Mark-detecting models		Advanced, twin-output models	Advanced, external-input models
		NPN output	E3X-DA6-S	E3X-DAG6-S	E3X-DAB6-S	E3X-DA6TW-S	E3X-DA6RM-S
		PNP output	E3X-DA8-S	E3X-DAG8-S	E3X-DAB8-S	E3X-DA8TW-S	E3X-DA8RM-S
Connection method		Standard connector					
Weight (packed state)		Approx. 55 g					

Amplifier Unit Connectors

Item	E3X-CN11/21/22		E3X-CN12	
Rated current	2.5 A			
Rated voltage	50 V			
Contact resistance	20 mΩ max. (20 mVDC max., 100 mA max.) (The figure is for connection to the Amplifier Unit and the adjacent Connector. It does not include the conductor resistance of the cable.)			
No. of insertions (destruction)	50 times (The figure for the number of insertions is for connection to the Amplifier Unit and the adjacent Connector.)			
Materials	Housing	Polybutylene terephthalate (PBT)		
	Contacts	Phosphor bronze/gold-plated nickel		
Weight (packed state)	Approx. 55 g		Approx. 25 g	

Mobile Console

Item	E3X-MC11-S
Supply voltage	Charged with AC adapter
Connection method	Connected via adapter
Weight (packed state)	Approx. 580 g (Console only: 120 g)
Refer to <i>Operation Manual</i> provided with the Mobile Console for details.	









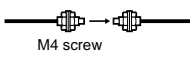
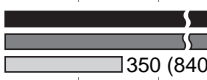

Ordering Information: Fiber Units

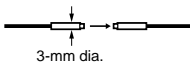
Through-beam Fiber Units

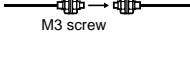
- Note 1.**  Indicates models that allow free cutting. Models without this mark do not allow free cutting.
- 2.** The size of standard sensing object is the same as the fiber core diameter (lens diameter for models with lens).
- 3.** The values for the minimum sensing object are representative values that indicate values obtained in standard mode with the sensing distance and sensitivity set to optimum values.

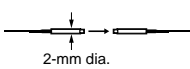
Long-distance Fiber Units

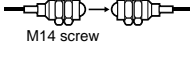
 : High-resolution mode  : Standard mode  : Super-high-speed mode

Features	Appearance	Applicable Amplifier Unit	Sensing distance (mm) (Parentheses: With E39-F1 Lens Unit)	Standard object (min. sensing object) (Parentheses: Opaque object)	Model	Permissible bending radius
M4 	 M4 screw	E3X-DA□-S E3X-DAG□-S E3X-DAB□-S	 1,700 (4,000) ^{*1} 1,330 (3,200) 350 (840) 150 120 75	1.4-mm dia. (0.01-mm dia.)	E32-T11L	25 mm
3-mm dia. 	 3-mm dia.	E3X-DA□-S	 1,700 1,330 350		E32-T12L	
M3 	 M3 screw	E3X-DA□-S	 540 440 100	0.9-mm dia. (0.005-mm dia.)	E32-T21L	10 mm
2-mm dia.; small diameter 	 2-mm dia.	E3X-DA□-S	 540 440 100		E32-T22L	
M14; with lens; ideal for explosion-proof applications 	 M14 screw	E3X-DA□-S	 20,000 ^{*2} 20,000 ^{*2} 4,000 ^{*2}	10-mm dia.	E32-T17L	25 mm

*1: The optical fiber is 2 m long on each side, so the sensing distance is 4,000 mm.

*2: The optical fiber for the E32-T17L is 10 m long on each side, so the value is 20,000 mm

A Wide Range of Flexible Fibers for Easy Installation without Loss of Light Intensity

Flexible fiber models are indicated by an "R" at the end of the model number.

Flexible fiber contains multiple cores. These cores are all surrounded by cladding, giving a minimum bending radius of 1 mm.

The fiber can be bent at right angles without affecting the light intensity. Handle it just like any other cable.

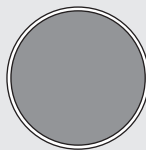

Conventional Fiber

Conventional fiber uses just one core and one cladding section. Bending the fiber may break it or reduce the light intensity.

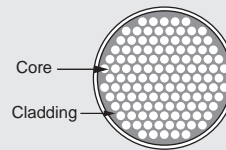

Flexible Fiber

Flexible fiber contains multiple independent cores all surrounded by cladding. The fiber can be bent without breaking or reducing the light intensity.

General-purpose Fiber Units

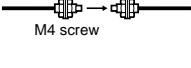
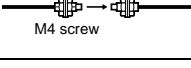
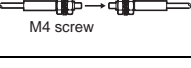
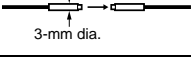
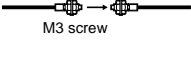
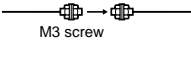
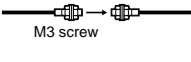
Features	Appearance	Applicable Amplifier Unit	Sensing distance (mm) (Parentheses: With E39-F1 Lens Unit)	Standard object (min. sensing object) (Parentheses: Opaque object)	Model	Permissible bending radius
M4	 M4 screw	E3X-DA□-S E3X-DAG□-S E3X-DAB□-S	1,000 (4,000)* 760 (4,000)* 200 (1,500)	1.0-mm dia. (0.005-mm dia.)	E32-TC200	25 mm
M4	 M4 screw	E3X-DA□-S	700 (4,000)* 530 (3,700) 140 (970)		E32-T11R	1 mm
M4 Fiber sheath material: fluororesin	 M4 screw	E3X-DA□-S	900 (4,000)* 680 (3,600) 180 (930)		E32-T11U NEW	4 mm
3-mm dia.	 3-mm dia.	E3X-DA□-S	700 530 140		E32-T12R	1 mm
M3 Possible to mount the E39-F5 Reflective Side-view Conversion Attachment	 M3 screw	E3X-DA□-S	900 680 180		E32-TC200A	25 mm
M3; for detecting minute sensing objects	 M3 screw	E3X-DA□-S E3X-DAG□-S E3X-DAB□-S	270 220 50 25 20 12	0.5-mm dia. (0.005-mm dia.)	E32-TC200E	10 mm
M3	 M3 screw	E3X-DA□-S	160 130 30		E32-T21R	1 mm

* The optical fiber is 2 m long on each side, so the sensing distance is 4,000 mm.

Fiber Units with Thin Heads

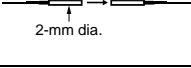
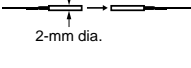
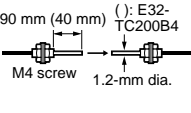
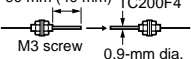



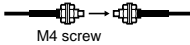
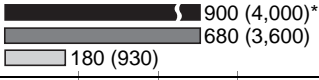
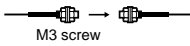
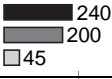
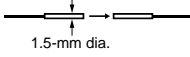
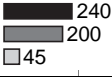

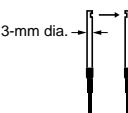

Features	Appearance	Applicable Amplifier Unit	Sensing distance (mm) (Parentheses: With E39-F1 Lens Unit)	Standard object (min. sensing object) (Parentheses: Opaque object)	Model	Permissible bending radius
2-mm dia.; for detecting minute sensing objects	 2-mm dia.	E3X-DA□-S	270 220 50	0.5-mm dia. (0.005-mm dia.)	E32-T22	10 mm
2-mm dia.; for detecting minute sensing objects	 2-mm dia.	E3X-DA□-S	160 130 30		E32-T22R	1 mm
1.2-mm dia.; with sleeve	 90 mm (40 mm) (): E32-TC200B4 M4 screw 1.2-mm dia.	E3X-DA□-S E3X-DAG□-S E3X-DAB□-S	1,000 760 200 100 75 45	1.0-mm dia. (0.005-mm dia.)	E32-TC200B E32-TC200B4	25 mm
0.9-mm dia.; with sleeve	 90 mm (40 mm) (): E32-TC200F4 M3 screw 0.9-mm dia.	E3X-DA□-S	270 220 50	0.5-mm dia. (0.005-mm dia.)	E32-TC200F E32-TC200F4	10 mm

Flexible Fiber Units (Resists Breaking) (R4)

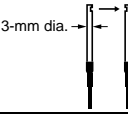
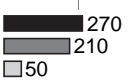
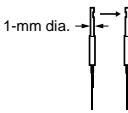
Features	Appearance	Applicable Amplifier Unit	Sensing distance (mm) (Parentheses: With E39-F1 Lens Unit)	Standard object (min. sensing object) (Parentheses: Opaque object)	Model	Permissible bending radius
Ideal for mounting on moving sections (R4)	 M4 screw	E3X-DA□-S	 900 (4,000)* 680 (3,600) 180 (930)	1.0-mm dia. (0.005-mm dia.)	E32-T11	4 mm
	 M3 screw	E3X-DA□-S	 240 200 45		E32-T21	
	 1.5-mm dia.	E3X-DA□-S	 240 200 45		E32-T22B	

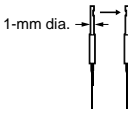
* The optical fiber is 2 m long on each side, so the sensing distance is 4,000 mm.

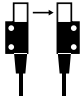
Side-view Fiber Units

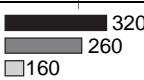
Features	Appearance	Applicable Amplifier Unit	Sensing distance (mm) (Parentheses: With E39-F1 Lens Unit)	Standard object (min. sensing object) (Parentheses: Opaque object)	Model	Permissible bending radius
Long distance; space-saving	 3-mm dia.	E3X-DA□-S	 600 460 120	1.0-mm dia. (0.005-mm dia.)	E32-T14L	25 mm
		E3X-DAG□-S E3X-DAB□-S	 50 40 25		E32-T14LR	1 mm
Space-saving	 3-mm dia.	E3X-DA□-S	 270 210 50			
Suitable for detecting minute sensing objects; small diameter	 1-mm dia.	E3X-DA□-S	 160 130 30	0.5-mm dia. (0.005-mm dia.)	E32-T24	10 mm
Suitable for detecting minute sensing objects; small diameter	 1-mm dia.	E3X-DA□-S	 60 50 10		E32-T24R	1 mm
Screw-mounting type		E3X-DA□-S	 4,500 3,400 900	4-mm dia. (0.1-mm dia.)	E32-T14	25 mm
		E3X-DAG□-S E3X-DAB□-S	 320 260 160			

Chemical-resistant Fiber Units

Features	Appearance	Applicable Amplifier Unit	Sensing distance (mm) (Parentheses: With E39-F1 Lens Unit)	Standard object (min. sensing object) (Parentheses: Opaque object)	Model	Permissible bending radius
<p>Free-cut</p> <p>Teflon-covered*; round head that resists water drops</p>		E3X-DA□-S		4-mm dia. (0.1-mm dia.)	E32-T11F NEW	4 mm
<p>Free-cut</p> <p>Teflon-covered*; withstands chemicals and harsh environments (operating ambient temperature: -30°C to 70°C)</p>		E3X-DA□-S		4-mm dia. (0.1-mm dia.)	E32-T12F	40 mm
<p>Free-cut</p> <p>Teflon-covered*; withstands chemicals and harsh environments; side-view (operating ambient temperature: -30°C to 70°C)</p>		E3X-DA□-S		3-mm dia. (0.1-mm dia.)	E32-T14F	40 mm
<p>Teflon*; withstands chemicals and harsh environments (operating ambient temperature: -40°C to 200°C)</p>		E3X-DA□-S		1.0-mm dia. (0.005-mm dia.)	E32-T81F-S NEW	10 mm

* Teflon is a registered trademark of the Dupont Company and the Mitsui Dupont Chemical Company for their fluoride resin.

Heat-resistant Fiber Units

Features	Appearance	Applicable Amplifier Unit	Sensing distance (mm) (Parentheses: With E39-F1 Lens Unit)	Standard object (min. sensing object) (Parentheses: Opaque object)	Model	Permissible bending radius
<p>Free-cut</p> <p>Resists 150°C^{*1}; fiber sheath material: fluororesin (operating ambient temperature: -40°C to 150°C)</p>		E3X-DA□-S	<p>1,000</p> <p>760</p> <p>200</p>	1.5-mm dia. (0.1-mm dia.)	E32-T51	35 mm
<p>Resists 200°C; flexible (R10); fiber sheath material: Teflon^{*2} (operating ambient temperature: -40°C to 200°C)</p>		E3X-DA□-S	<p>360 (2,650)</p> <p>280 (2,100)</p> <p>70 (520)</p>	1.0-mm dia. (0.005-mm dia.)	E32-T81R-S NEW	10 mm
<p>Resists 350°C^{*3}, with spiral tube; high mechanical strength; fiber sheath material: stainless steel (operating ambient temperature: -60°C to 350°C)</p>		E3X-DA□-S	<p>600 (4,000)^{*4}</p> <p>450 (3,400)</p> <p>120 (900)</p>		E32-T61-S NEW	25 mm
<p>Free-cut</p> <p>Side-view; resists 150°C^{*1}; suitable for detecting minute sensing objects; fiber sheath material: fluororesin (operating ambient temperature: -40°C to 150°C)</p>		E3X-DA□-S	<p>300</p> <p>230</p> <p>60</p>		E32-T54	35 mm
<p>Resists 200°C^{*3}; L-shaped; fiber sheath material: stainless steel</p>		E3X-DA□-S	<p>1,750</p> <p>1,300</p> <p>350</p>	1.7-mm dia. (0.1-mm dia.)	E32-T84S-S NEW	25 mm

*1: For continuous operation, use the products within a temperature range of -40°C to 130°C.

*2: Teflon is a registered trademark of the Dupont Company and the Mitsui Dupont Chemical Company for their fluoride resin.

*3: Indicates the heat-resistant temperature at the fiber tip.

*4: The optical fiber is 2 m long on each side, so the sensing distance is 4,000 mm.

Fiber Unit with Slot Sensor

Features	Appearance	Applicable Amplifier Unit	Sensing distance (mm) (Parentheses: With E39-F1 Lens Unit)	Standard object (min. sensing object) (Parentheses: Opaque object)	Model	Permissible bending radius
<p>Free-cut</p> <p>Suitable for film sheet detection; no optical axis adjustment required; easy to mount</p>		<p>E3X-DA□-S</p> <p>E3X-DAG□-S</p> <p>E3X-DAB□-S</p>	<p>10</p> <p>10</p> <p>10</p>	4-mm dia. (0.1-mm dia.)	E32-G14	25 mm

Fiber Units with a Narrow Vision Field

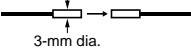
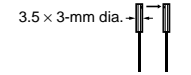
Features	Appearance	Applicable Amplifier Unit	Sensing distance (mm) (Parentheses: With E39-F1 Lens Unit)	Standard object (min. sensing object) (Parentheses: Opaque object)	Model	Permissible bending radius
Free-cut Suitable for detecting wafers	 3-mm dia.	E3X-DA□-S	2,500 1,900 500	1.7-mm dia. (0.1-mm dia.)	E32-T22S	25 mm
Free-cut Side-view; suitable for detecting wafers	 3.5 x 3-mm dia.	E3X-DA□-S	1,750 1,300 350	2-mm dia. (0.1-mm dia.)	E32-T24S	10 mm

Area-sensing Fiber Units

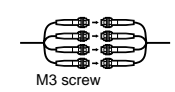
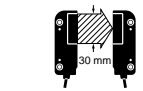
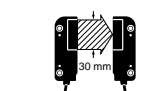
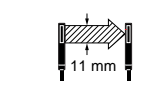
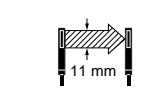
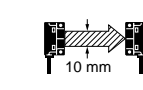
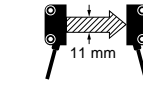
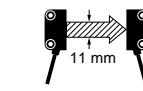
Features	Appearance	Applicable Amplifier Unit	Sensing distance (mm) (Parentheses: With E39-F1 Lens Unit)	Standard object (min. sensing object) (Parentheses: Opaque object)	Model	Permissible bending radius
Multi-point detection (4-head)	 M3 screw	E3X-DA□-S	750 610 140	2-mm dia. (0.1-mm dia.)	E32-M21	25 mm
Free-cut Detects in a 30-mm area		E3X-DA□-S	2,300 1,800 450	(0.3-mm dia.) ^{*1}	E32-T16W	10 mm
		E3X-DA□-S	1,700 1,300 340		E32-T16WR	1 mm
Free-cut Side-view; suitable for applications with limited spatial depth		E3X-DA□-S	1,300 1,000 260	(0.2-mm dia.) ^{*1}	E32-T16J	10 mm
		E3X-DA□-S	980 750 190		E32-T16JR	1 mm
Free-cut Suitable for detecting over a 10-mm area; long distance		E3X-DA□-S	3,700 2,800 740	(0.6-mm dia.) ^{*2}	E32-T16	25 mm
Free-cut Stable for detecting minute sensing objects in a wide area		E3X-DA□-S	1,500 1,100 300	(0.2-mm dia.) ^{*1}	E32-T16P	10 mm
		E3X-DA□-S	1,100 840 220		E32-T16PR	1 mm

*1: These figures are for a sensing distance of 300 mm. (Figures for the diameter of sensing objects are in the still state.)

*2: These figures are ones for which detection is possible in each sensing area at a digital incident level of 1,000. (Figures for the diameter of sensing objects are in the still state.)









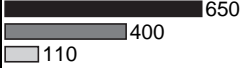

■ Fiber Units with Reflective Sensors

Note 1.  Indicates models that allow free cutting. Models without this mark do not allow free cutting.

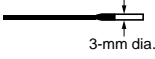
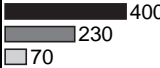
2. The values for the minimum sensing object are representative values that indicate values obtained in standard mode with the sensing distance and sensitivity set to optimum values.

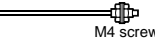
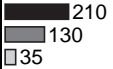
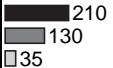
3. When set to the maximum sensitivity setting, internal light reflection may cause the sensor to detect incident light. In such case, use adjust the threshold either manually or using teaching.

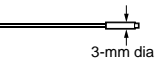
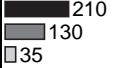
Long-distance Fiber Units

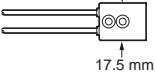
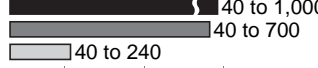
Features	Appearance	Applicable Amplifier Unit	Sensing distance (mm)*	Standard object (min. sensing object: Gold wire)	Model	Permissible bending radius
M6 	 M6 screw	E3X-DA□-S		500×500 (0.005-mm dia.)	E32-D11L	25 mm
		E3X-DAG□-S E3X-DAB□-S		100×100 (0.1-mm dia.)		
3-mm dia.; small diameter 	 3-mm dia.	E3X-DA□-S		300×300 (0.005-mm dia.)	E32-D12	
M4 	 M4 screw	E3X-DA□-S		200×200 (0.005-mm dia.)	E32-D21L	10 mm
		E3X-DA□-S			E32-D22L	
3-mm dia.; small diameter 	 3-mm dia.	E3X-DA□-S				
Square head, super-long distance 	 17.5 mm	E3X-DA□-S		300×300	E32-D16 NEW	4 mm

* Values are sensed for white paper (standard sensing object).

General-purpose Fiber Units

Features	Appearance	Applicable Amplifier Unit	Sensing distance (mm)*	Standard object (min. sensing object: Gold wire)	Model	Permissible bending radius
M6		E3X-DA□-S	500 300 90	400×400 (0.005-mm dia.)	E32-DC200	25 mm
		E3X-DAG□-S E3X-DAB□-S	32 25 16	100×100 (0.1-mm dia.)		
M6		E3X-DA□-S	300 170 50	300×300 (0.005-mm dia.)	E32-D11R	1 mm
M6 Fiber sheath material: fluororesin		E3X-DA□-S	300 170 50		E32-D11U <i>NEW</i>	4 mm
3-mm dia.		E3X-DA□-S	300 170 50		E32-D12R	1 mm
M3; small diameter		E3X-DA□-S	130 80 22	100×100 (0.005-mm dia.)	E32-DC200E	10 mm
		E3X-DAG□-S E3X-DAB□-S	18 16 14	25×25 (0.2-mm dia.)		
M3; small diameter		E3X-DA□-S	50 30 18	50×50 (0.005-mm dia.)	E32-D21R	1 mm
3-mm dia.; small diameter		E3X-DA□-S	50 30 18		E32-D22R	





* Values are sensed for white paper (standard sensing object).

Fiber Units with Thin Heads

Features	Appearance	Applicable Amplifier Unit	Sensing distance (mm)*	Standard object (min. sensing object: Gold wire)	Model	Permissible bending radius
2.5-mm dia.; with sleeve		E3X-DA□-S	500 300 90	400×400 (0.005-mm dia.)	E32-DC200B E32-DC200B4	25 mm
		E3X-DAG□-S E3X-DAB□-S	32 25 16	100×100 (0.1-mm dia.)		
1.2-mm dia.; with sleeve		E3X-DA□-S	130 80 22	100×100 (0.005-mm dia.)	E32-DC200F E32-DC200F4	10 mm
0.8-mm dia.; for detecting minute sensing objects		E3X-DA□-S	25 16 14	25×25 (0.005-mm dia.)	E32-D33	4 mm
0.5-mm dia.; for detecting very minute sensing objects		E3X-DA□-S	15 13 10.8			







* Values are sensed for white paper (standard sensing object).

Flexible Fiber Units (Resists Breaking) (R4)

Features	Appearance	Applicable Amplifier Unit	Sensing distance (mm)*	Standard object (min. sensing object: Gold wire)	Model	Permissible bending radius
Ideal for mounting on moving sections (R4)		E3X-DA□-S	300 170 50	300×300 (0.005-mm dia.)	E32-D11	4 mm
		E3X-DA□-S	50 30 18	50×50 (0.005-mm dia.)	E32-D21	
		E3X-DA□-S	110 70 20	100×100 (0.005-mm dia.)	E32-D21B	
		E3X-DA□-S	50 30 18	50×50 (0.005-mm dia.)	E32-D22B	

* Values are sensed for white paper (standard sensing object).

Coaxial Fiber Units

Features	Appearance	Applicable Amplifier Unit	Sensing distance (mm)*	Standard object (min. sensing object: Gold wire)	Model	Permissible bending radius
M6 coaxial; high-precision positioning		E3X-DA□-S	500 300 90	500×500 (0.005-mm dia.)	E32-CC200	25 mm
		E3X-DAG□-S E3X-DAB□-S	32 25 16	100×100 (0.1-mm dia.)		
3-mm dia.; small diameter; coaxial; high-precision positioning		E3X-DA□-S	250 150 45	300×300 (0.005-mm dia.)	E32-D32L	
M3 coaxial; high-precision positioning		E3X-DA□-S	120 75 22	100×100 (0.005-mm dia.) Spot diameter • 0.5-mm dia. • 4.0-mm dia. max.	E32-C31	
M3 coaxial; high-precision positioning		E3X-DA□-S	50 35 18	50×50 (0.005-mm dia.) Spot diameter • 0.1-mm dia. • 0.2-mm dia. • 4.0-mm dia. max.	E32-C41	
2-mm dia. coaxial; high-precision positioning		E3X-DA□-S	50 35 18	50×50 (0.005-mm dia.) Spot diameter • Adjustable in the range 0.1 to 0.6-mm dia.	E32-C42	
2-mm dia. coaxial; high-precision positioning		E3X-DA□-S	120 75 22	100×100 (0.005-mm dia.) Spot diameter • Adjustable in the range 0.5 to 1-mm dia.	E32-D32	

* Values are sensed for white paper (standard sensing object).

Side-view Fiber Units

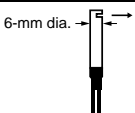
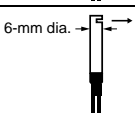
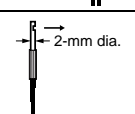
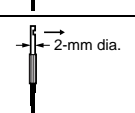
Features	Appearance	Applicable Amplifier Unit	Sensing distance (mm)*	Standard object (min. sensing object: Gold wire)	Model	Permissible bending radius
6-mm dia.; long distance <small>(Free-cut)</small>		E3X-DA□-S	■ 200 ■ 110 □ 36	200×200 (0.005-mm dia.)	E32-D14L	25 mm
6-mm dia. <small>(Free-cut)</small>		E3X-DA□-S	■ 80 ■ 45 □ 14	100×100 (0.005-mm dia.)	E32-D14LR	1 mm
2-mm dia.; small diameter; space-saving <small>(Free-cut)</small>		E3X-DA□-S	■ 50 □ 30 □ 8	50×50 (0.005-mm dia.)	E32-D24	10 mm
		E3X-DA□-S	■ 26 □ 15 □ 4		E32-D24R	1 mm

* Values are sensed for white paper (standard sensing object).

Chemical-resistant Fiber Units

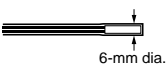
Features	Appearance	Applicable Amplifier Unit	Sensing distance (mm) ¹	Standard object (min. sensing object: Gold wire)	Model	Permissible bending radius
Teflon-covered ² ; withstands chemicals and harsh environments (operating ambient temperature: -30°C to 70°C) <small>(Free-cut)</small>		E3X-DA□-S	■ 160 ■ 95 □ 30	200×200 (0.005-mm dia.)	E32-D12F	40 mm

*1: Values are sensed for white paper (standard sensing object).

*2: Teflon is a registered trademark of the Dupont Company and the Mitsui Dupont Chemical Company for their fluoride resin.

Heat-resistant Fiber Units

Features	Appearance	Applicable Amplifier Unit	Sensing distance (mm) ^{*1}	Standard object (min. sensing object: Gold wire)	Model	Permissible bending radius
<p>Free-cut</p> <p>Resists 150°C^{*3}; fiber sheath material: fluororesin (operating ambient temperature: -40°C to 150°C)</p>		E3X-DA□-S		200×200 (0.005-mm dia.)	E32-D51	35 mm
<p>Resists 200°C^{*3}; fiber sheath material: fluororesin (operating ambient temperature: -40°C to 200°C)</p>		E3X-DA□-S			E32-D81R-S NEW	10 mm
<p>Resists 350°C^{*3}; fiber sheath material: stainless steel (operating ambient temperature: -60°C to 350°C)</p>		E3X-DA□-S			E32-D61-S NEW	25 mm
<p>Resists 400°C^{*3}; fiber sheath material: stainless steel (operating ambient temperature: -40°C to 400°C)</p>		E3X-DA□-S		100×100 (0.005-mm dia.)	E32-D73-S NEW	

- *1: Values are sensed for white paper (standard sensing object).
- *2: For continuous operation, use the products within a temperature range of -40°C to 130°C.
- *3: Indicates the heat-resistant temperature at the fiber tip.

Area-sensing Fiber Units

Features	Appearance	Applicable Amplifier Unit	Sensing distance (mm)*	Standard object (min. sensing object: Gold wire)	Model	Permissible bending radius
<p>Free-cut</p> <p>Side-view; detection over wide areas</p>		E3X-DA□-S		300×300 (0.005-mm dia.)	E32-D36P1	25 mm













* Values are sensed for white paper (standard sensing object).

Retroreflective Fiber Units

Features	Appearance	Applicable Amplifier Unit	Sensing distance (mm)*	Standard object (min. sensing object: Gold wire)	Model	Permissible bending radius
<p>Free-cut</p> <p>Transparent object detection</p>		E3X-DA□-S		35-mm dia. (0.1-mm dia.)	E32-R21 + E39-R3 (Attachment)	10 mm
<p>Free-cut</p> <p>Transparent object detection (operating ambient temperature: -25°C to 55°C); degree of protection: IEC60529 IP66</p>		E3X-DA□-S		35-mm dia. (0.2-mm dia.)	E32-R16 + E39-R1 (Attachment)	25 mm

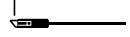



* Values are sensed for white paper (standard sensing object).

Limited-reflective Fiber Units

Features	Appearance	Applicable Amplifier Unit	Sensing distance (mm)*			Standard object (min. sensing object: Gold wire)	Model	Permissible bending radius
 Suitable for positioning liquid crystal glass		E3X-DA□-S	10 to 15 10 to 15 10 to 15			100×100 Soda glass with reflection factor of 7%	E32-L16 NEW	25 mm
 Suitable for positioning liquid crystal glass		E3X-DA□-S	14 to 12 14 to 12 14 to 12				E32-L56E1 E32-L56E2	35 mm
Suitable for positioning liquid crystal glass (Resists 300°C)		E3X-DA□-S	15 to 18 15 to 18 15 to 18				E32-L66 NEW	25 mm
 Liquid crystal glass, mounting detection, small		E3X-DA□-S	10 to 4 10 to 4 10 to 4			25×25 (0.005-mm dia.)	E32-L24S NEW	10 mm
 Detects wafers and small differences in height; (operating ambient temperature: -40°C to 105°C); degree of protection: IEC60529 IP50		E3X-DA□-S	14±2 14±2 14±2				E32-L24L	10 mm
		E3X-DA□-S	17.2±1.8 17.2±1.8 17.2±1.8				E32-L25L	
 Detects wafers and small differences in height; degree of protection: IEC60529 IP50		E3X-DA□-S	13.3 13.3 13.3				E32-L25	25 mm
		E3X-DA□-S	13.3 13.3 13.3				E32-L25A	

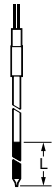
* Values are sensed for white paper (standard sensing object).

Fluid-level Detection Fiber Units

Features	Appearance	Applicable Amplifier Unit	Sensing distance (mm)	Standard object (min. sensing object: Gold wire)	Model	Permissible bending radius
Fluid contact type: unbendable section L 150 mm, 350 mm (two types); (operating ambient temperature: -40°C to 200°C)		E3X-DA□-S	---	Pure water at 25°C	E32-D82F1 E32-D82F2	40 mm
Free-cut Tube-mounting type; Light ON when fluid is present; minimal influence from bubbles and water drops		E3X-DA□-S	Applicable tube: Transparent tube Tube diameter: 3.2, 6.4, or 9.5 mm (Tube must be FEP or material with equivalent transparency; recommended wall thickness: 1 mm)		E32-A01	4 mm
Free-cut Tube-mounting type; light ON when fluid is present; minimal influence from bubbles and water drops		E3X-DA□-S	Applicable tube: Transparent tube Tube diameter: 6 to 13 mm (Tube must be FEP or material with equivalent transparency; recommended wall thickness: 1 mm)		E32-A02	
Free-cut Tube-mounting type; dense mounting to detect level differences of 4 mm		E3X-DA□-S	Applicable tube: Transparent tube Tube diameter: 8 to 10 mm (Tube must be FEP or material with equivalent transparency; recommended wall thickness: 1 mm)		E32-L25T	10 mm
Free-cut Tube-mounting type; unlimited tube diameter; minimal influence from bubbles and water drops		E3X-DA□-S	Applicable tube: Transparent tube Tube diameter: No restriction (Tube must be FEP or material with equivalent transparency)		E32-D36F	4 mm

Mapping Sensors (Through-beam)

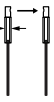
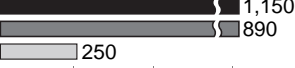
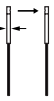
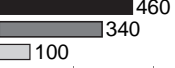
Features	Appearance	Applicable Amplifier Unit	Sensing distance (mm)	Standard object (min. sensing object: Gold wire)	Model	Permissible bending radius
Free-cut Super-narrow vision field; side-view; opening angle: 1.5°; simple adjustment	3-mm dia. 	E3X-DA□-S		2-mm dia. (0.1-mm dia.)	E32-A03	1 mm
Free-cut Super-narrow vision field; small; side-view; opening angle: 3°; simple adjustment	2-mm dia. 	E3X-DA□-S		1.2-mm dia. (0.1-mm dia.)	E32-A04	10 mm

Output Circuits

NPN Output

Model	Mode selector	Timing chart	Mode selector	Output circuit
E3X-DA11-S E3X-DA6-S E3X-DAG11-S E3X-DAG6-S E3X-DAB11-S E3X-DAB6-S	LIGHT ON (L/ON)	Incident light No incident light Operation indicator (orange) ON OFF Output transistor ON OFF Load (relay) Operate Release (Between brown and black)	Light ON	
	DARK ON (D/ON)	Incident light No incident light Operation indicator (orange) ON OFF Output transistor ON OFF Load (relay) Operate Release (Between brown and black)	Dark ON	
E3X-DA11TW-S E3X-DA6TW-S	LIGHT ON (L/ON)	CH1/CH2 Incident light No incident light Operation indicator (orange) ON OFF Output transistor ON OFF Load (relay) Operate Release (Between brown and black)	Light ON	
	DARK ON (D/ON)	CH1/CH2 Incident light No incident light Operation indicator (orange) ON OFF Output transistor ON OFF Load (relay) Operate Release (Between brown and black)	Dark ON	
E3X-DA11RM-S E3X-DA6RM-S	LIGHT ON (L/ON)	Incident light No incident light Operation indicator (orange) ON OFF Output transistor ON OFF Load (relay) Operate Release (Between brown and black)	Light ON	
	DARK ON (D/ON)	Incident light No incident light Operation indicator (orange) ON OFF Output transistor ON OFF Load (relay) Operate Release (Between brown and black)	Dark ON	

Note 1. The ON/OFF regions when areas settings are used with the E3X-DA□TW-S are as follows:

- LIGHT ON: ON when the incident level is between the thresholds for channels 1 and 2.
- DARK ON: OFF when the incident level is between the thresholds for channels 1 and 2.

2. Time Charts for Timer Settings (T: Set Time)

ON delay	OFF delay	One-shot
Incident light No incident light L-ON ON OFF OFF ON OFF D-ON ON OFF	Incident light No incident light L-ON ON OFF OFF ON OFF D-ON ON OFF	Incident light No incident light L-ON ON OFF OFF ON OFF D-ON ON OFF

PNP Output

Model	Mode selector	Timing chart	State of output transistor	Output circuit
E3X-DA41-S E3X-DA8-S E3X-DAG41-S E3X-DAG8-S E3X-DAB41-S E3X-DAB8-S	LIGHT ON (L/ON)	Incident light No incident light Operation indicator (orange) ON OFF Output transistor ON OFF Operate Load (relay) Release (Between blue and black)	Light ON	
	DARK ON (D/ON)	Incident light No incident light Operation indicator (orange) ON OFF Output transistor ON OFF Operate Load (relay) Release (Between blue and black)	Dark ON	
E3X-DA41TW-S E3X-DA8TW-S	LIGHT ON (L/ON)	CH1/ Incident light CH2 No incident light Operation indicator (orange) ON OFF Output transistor ON OFF Operate Load (relay) Release (Between blue and black)	Light ON	
	DARK ON (D/ON)	CH1/ Incident light CH2 No incident light Operation indicator (orange) ON OFF Output transistor ON OFF Operate Load (relay) Release (Between blue and black)	Dark ON	
E3X-DA41RM-S E3X-DA8RM-S	LIGHT ON (L/ON)	Incident light No incident light Operation indicator (orange) ON OFF Output transistor ON OFF Operate Load (relay) Release (Between blue and black)	Light ON	
	DARK ON (D/ON)	Incident light No incident light Operation indicator (orange) ON OFF Output transistor ON OFF Operate Load (relay) Release (Between blue and black)	Dark ON	

Note 1. The ON/OFF regions when areas settings are used with the E3X-DA□TW-S are as follows:

LIGHT ON: ON when the incident level is between the thresholds for channels 1 and 2.

DARK ON: OFF when the incident level is between the thresholds for channels 1 and 2.

2. Time Charts for Timer Settings (T: Set Time)

ON delay	OFF delay	One-shot
Incident light No incident light L-ON ON OFF D-ON ON OFF	Incident light No incident light L-ON ON OFF D-ON ON OFF	Incident light No incident light L-ON ON OFF D-ON ON OFF

Nomenclature

Amplifier Units

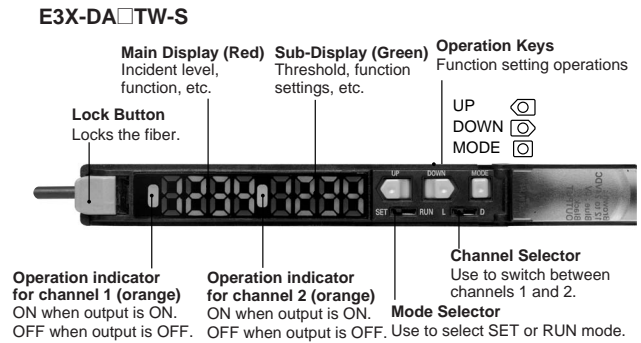
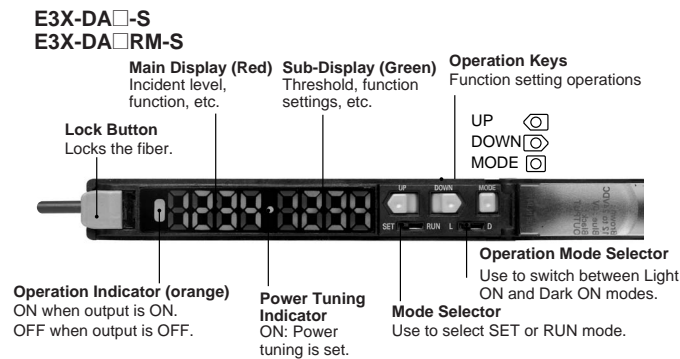

Adjustment Methods

1. Setting the Operation Mode

The operation mode is set with the Mode Selector.

Operation mode		Operation
Light ON	L-ON	L (Factory-set)
Dark ON	D-ON	D

* E3X-DA□TW-S: The operation mode is set in SET mode. Refer to 5. *Setting Functions in SET Mode* on page 22.

* E3X-DA□TW-S: Set the Channel Selector to the desired channel before making any adjustments or settings. This is true for all adjustments and settings.

2. Adjusting the Power (RUN Mode)

The current incident light level can be adjusted to near the power tuning target value (default: 2,000).

* Confirm that the MODE key setting is PTUN (power tuning). The default setting is PTUN. Refer to 5. *Setting Functions in SET Mode* on page 22

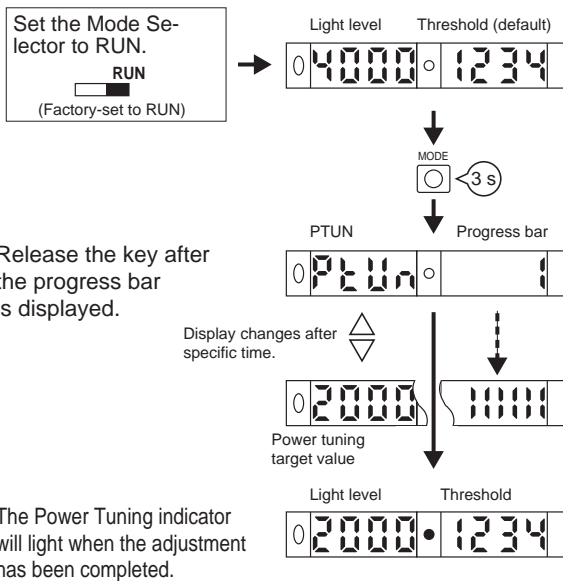

To restore the default power settings:

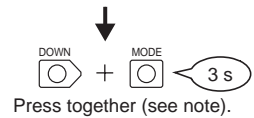

"OFF" will flash twice.



The Power Tuning indicator will go out when the default setting has been restored.

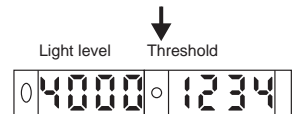

* Setting Errors

An error has occurred if one of the following displays appears after the progress bar is displayed.

Display	Error	Action
 PTUN OVER	Over Error The incident light level is too low for the power tuning target value.	The power will not be tuned. The power can be increased up to approximately 5 times the incident light value.
 PTUN BOTM	Bottom Error The incident light level is too high for the power tuning target value.	The power will be turned to the minimum level. The power can be decreased down to approximately 1/25th the incident light value.

Note: Press the DOWN key right after pressing the MODE key.

3. Setting Thresholds Manually (RUN Mode)

A threshold can be set manually. A threshold value can also be fine-tuned using manual setting after teaching.

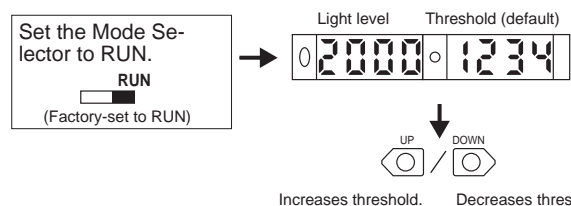

* Even if the display method for display switching is changed, the threshold will appear on the sub-display when the key is pressed.

4. Teaching the Threshold Value (SET Mode)

- * There are four methods that can be used for teaching, as described below. Use the method most suitable for the application.
- * An error has occurred if OVER, LO, or NEAR is displayed on the sub-display. Repeat the operation from the beginning.

4-1. Setting the Threshold at Maximum Sensitivity

The threshold can be set at the maximum sensitivity. This method is ideal when using a Through-beam Fiber Unit to detect workpieces so that detection is not influenced to any great degree by dust and other environmental factors.

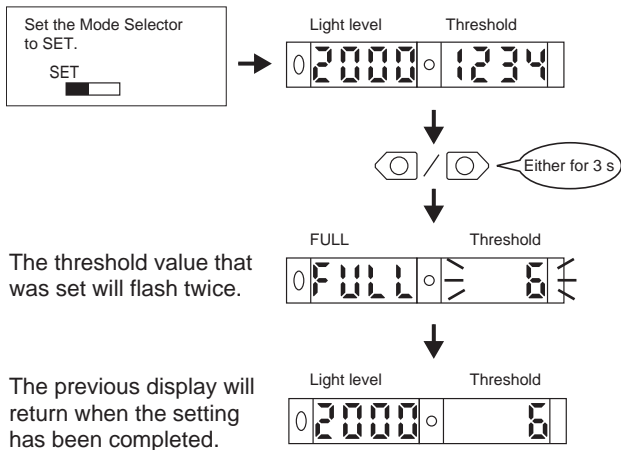

4-2. Teaching a Through-beam Fiber Unit without a Workpiece

A value about 6% less than the incident light level can be set as the threshold value. This method is ideal when detecting very small differences in light level, such as when detecting very fine workpieces or transparent workpieces like transparent fibers.

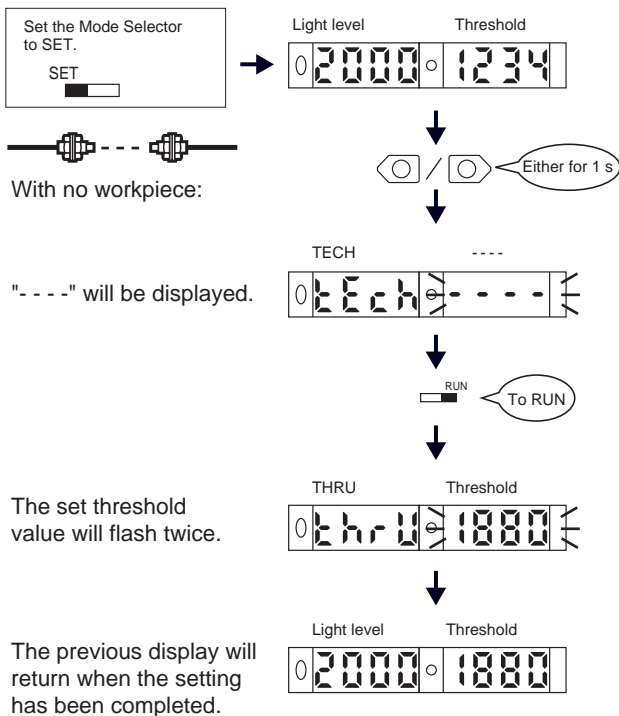

4-3. Teaching a Reflective Fiber Unit without a Workpiece

A value about 6% greater than the incident light level can be set as the threshold value. This method is ideal when using a Reflective Fiber Unit to detect workpieces so that detection is not influenced to any great degree by dust and other environmental factors.

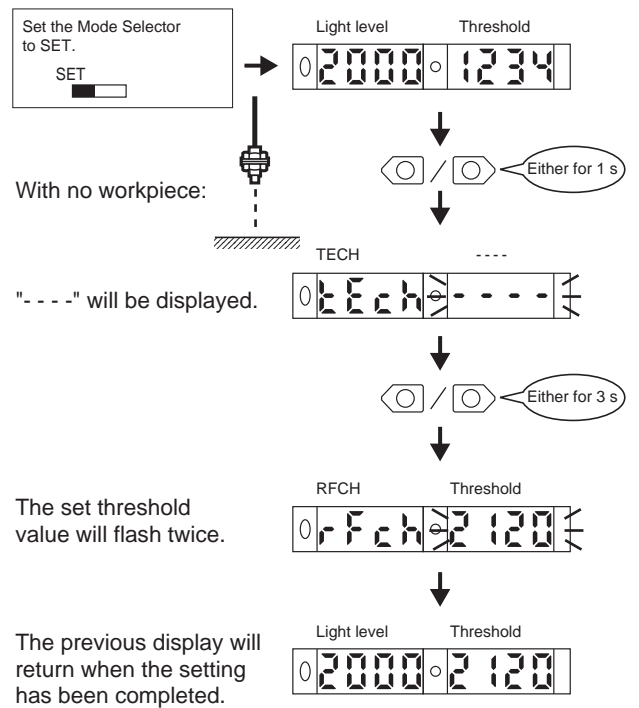

4-4. Teaching With and Without a Workpiece

Teaching can be performed twice, once with and once without a workpiece, and the value between the two measured value can be set as the threshold.

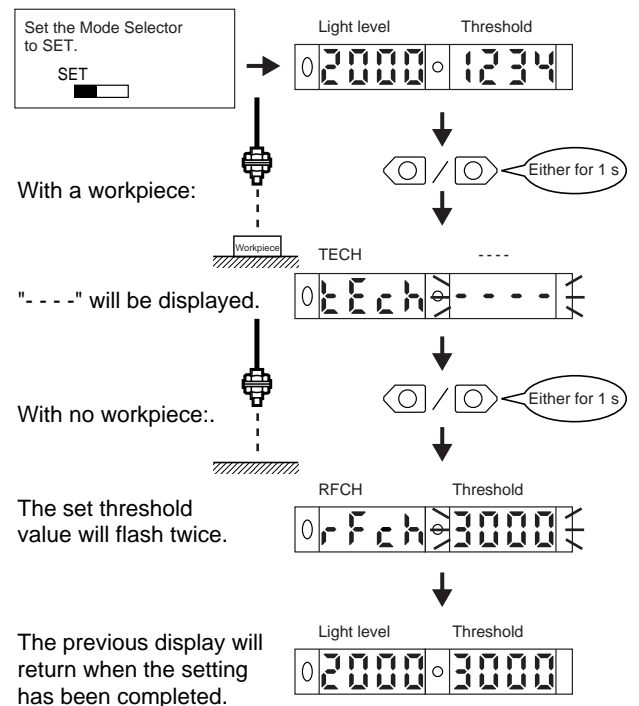

5. Setting Functions in SET Mode

*The default settings are shown in the transition boxes between functions.

For the E3X-DA□-S

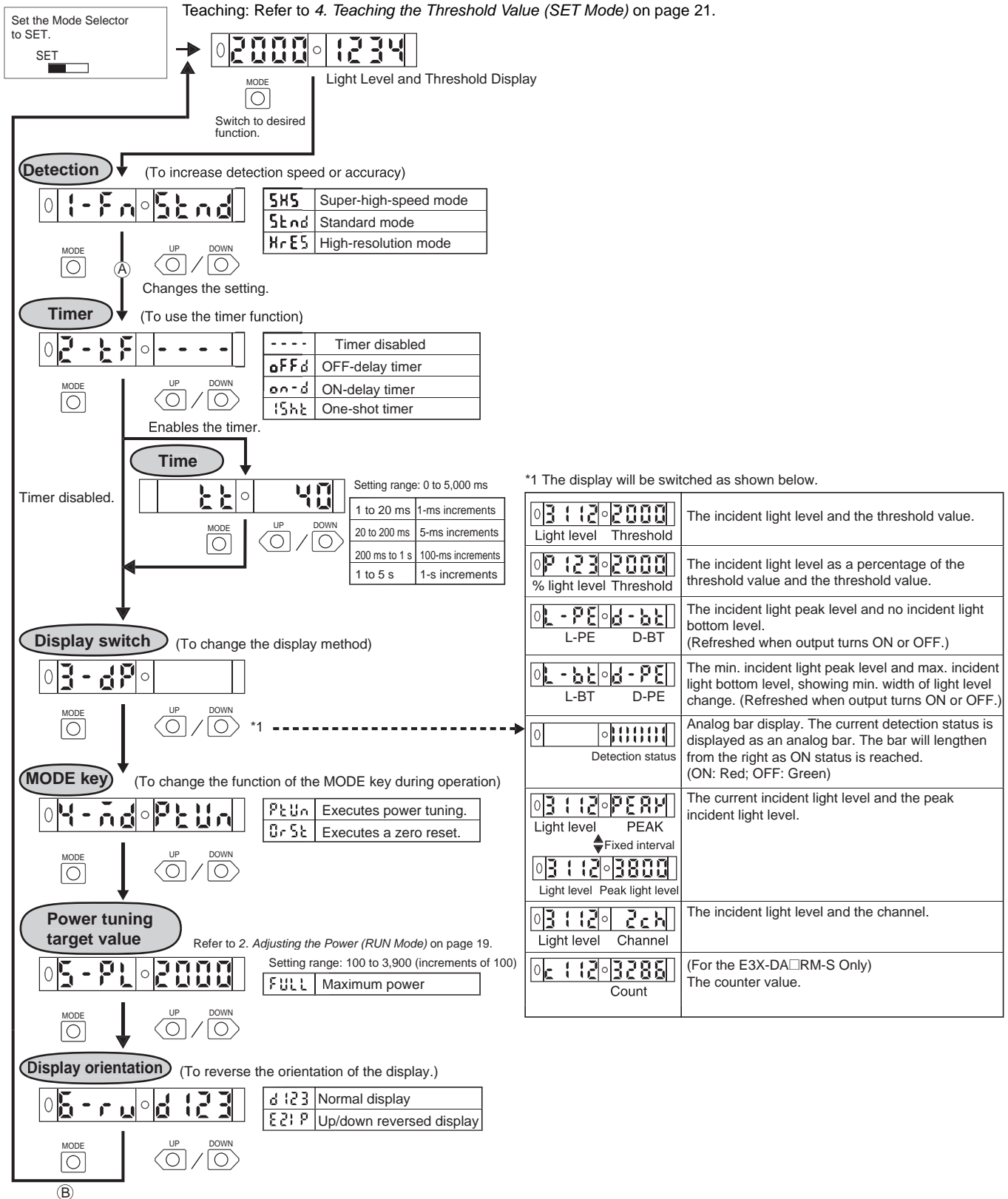

For the E3X-DA□TW-S

Teaching: Refer to 4. Teaching the Threshold Value (SET Mode) on page 21.

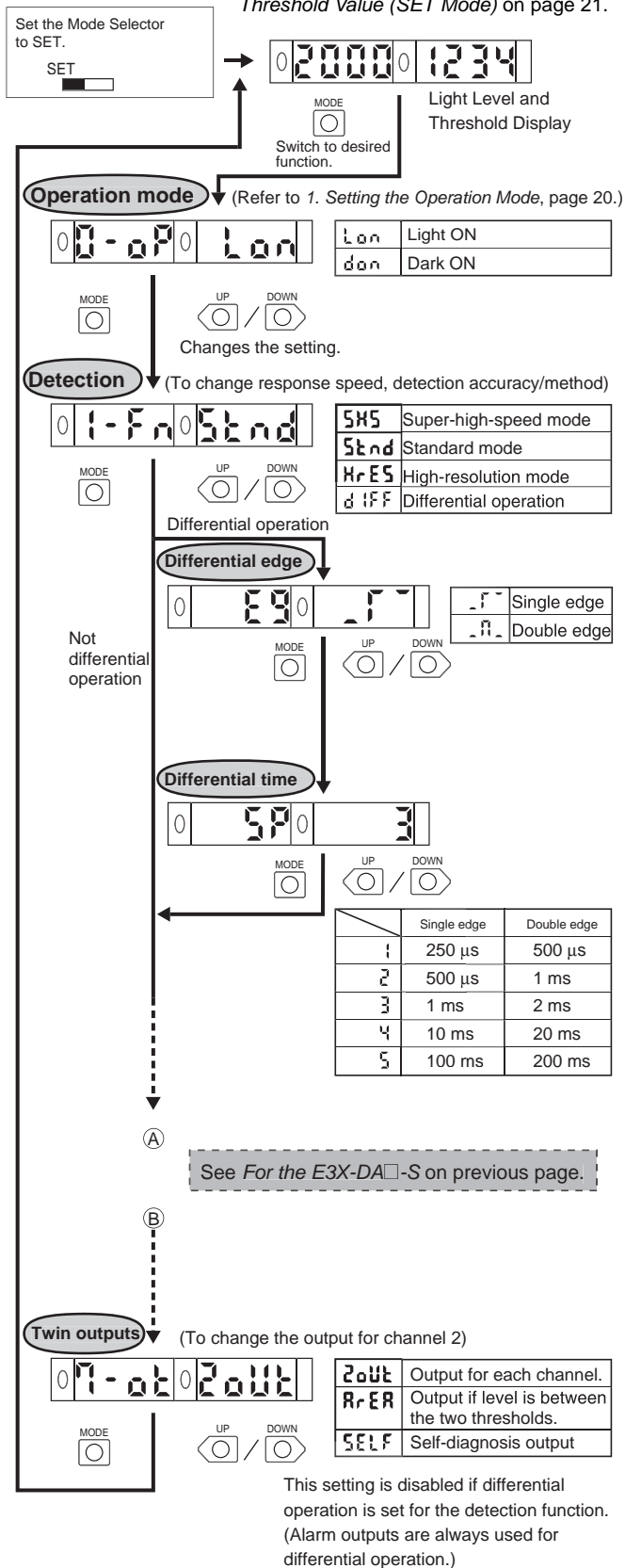

For the E3X-DA□RM-S

Teaching: Refer to 4. Teaching the Threshold Value (SET Mode) on page 21.

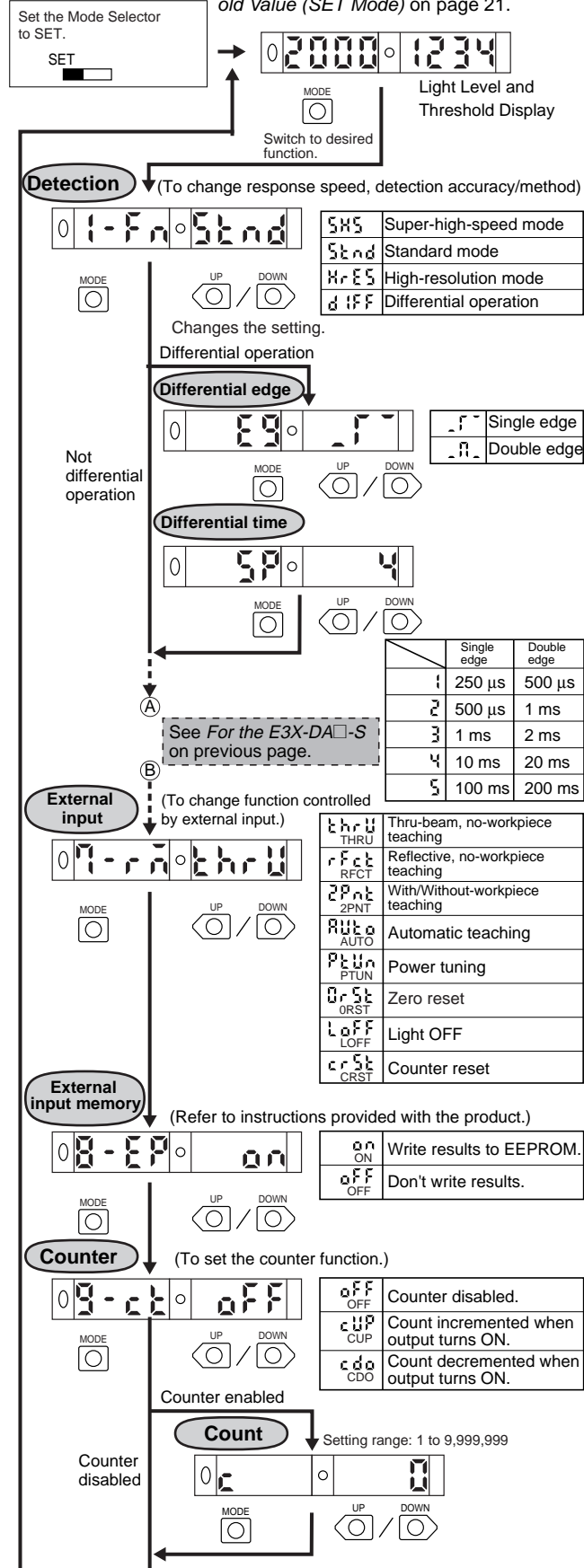

6. Convenient Functions

6-1. Zeroing the Digital Display

The incident light level on the digital display can be set to 0.

* Change the function to 0RST (zero reset) with the MODE key. The default setting is PTUN. Refer to 5. *Setting Functions in SET Mode* on page 22.

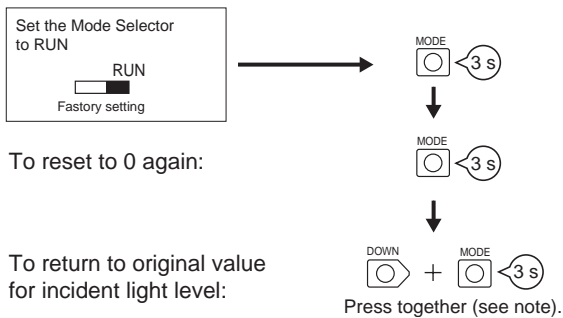

To reset to 0 again:

To return to original value for incident light level:

6-2. Locking the Keys

All key operations can be disabled.

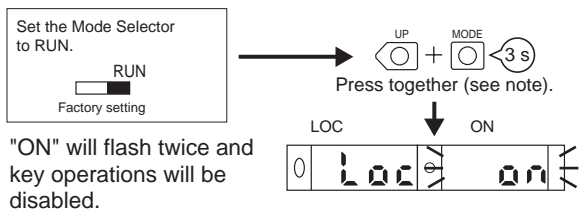

"ON" will flash twice and key operations will be disabled.

To release the lock:

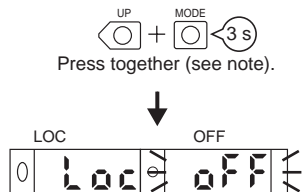

"OFF" will flash twice and key operations will be enabled.

* If a key is pressed while key operations are locked, "LOC" will flash twice on the display to indicate that key operations have been disabled.



Note: Press the DOWN key right after pressing the MODE key.

6-3. Initializing Settings

All settings can be returned to their original default settings.

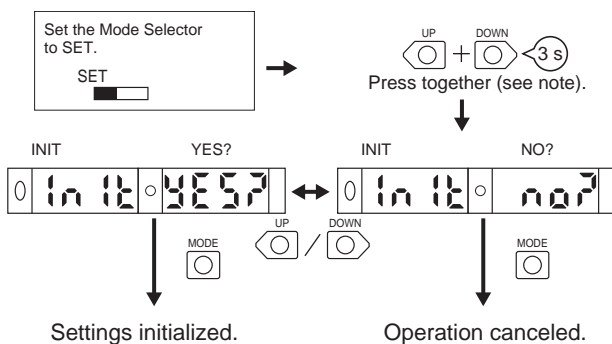

Safety Precautions

Note: In addition to the following precautions, please read and observe the common precautions for the instructions included with the product.

■ Precautions for Correct Use

Amplifier Unit

Installation

● Operation after Turning Power ON

The Amplifier Unit is ready to operate within 200 ms after the power supply is turned ON. If the Sensor and load are connected to power supplies separately, be sure to turn ON the power supply to the Sensor first.

Mounting

● Connecting and Disconnecting Connectors

Mounting Connectors

1. Insert the Master or Slave Connector into the Amplifier Unit until it clicks into place.

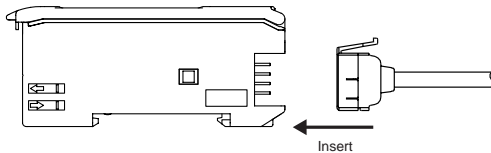

2. Attach the protector seals (provided as accessories) to the sides of master and slave connectors that are not connected.

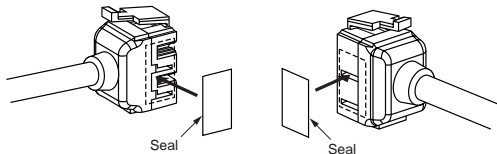

Note: Attach the seals to the sides with grooves

Removing Connectors

1. Slide the slave Amplifier Unit(s) for which the Connector is to be removed away from the rest of the group.
2. After the Amplifier Unit(s) has been separated, press down on the lever on the Connector and remove it. (Do not attempt to remove Connectors without separating them from other Amplifier Units first.)

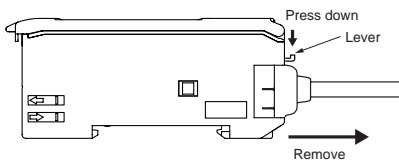

● Joining and Removing Amplifier Units

Joining Amplifier Units

1. Mount the Amplifier Units one at a time onto the DIN track.

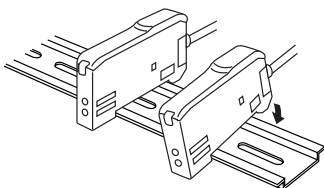

2. Slide the Amplifier Units together, line up the clips, and press the Amplifier Units together until they click into place.

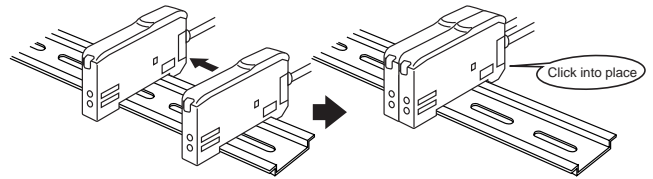

Separating Amplifier Units

Slide Amplifier Units away from each other, and remove from the DIN track one at a time. (Do not attempt to remove Amplifier Units from the DIN track without separating them first.)

- Note 1.** The specifications for ambient temperature will vary according to the number of Amplifier Units used together. For details, refer to *Ratings/Characteristics*.
2. Always turn OFF the power supply before joining or separating Amplifier Units.

● Mounting the End Plate (PFP-M)

An End Plate should be used if there is a possibility of the Amplifier Unit moving, e.g., due to vibration. If a Mobile Console is going to be mounted, connect the End Plate in the direction shown in the following diagram.

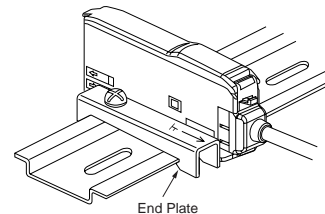

● Mounting the Mobile Console Head

Leave a gap of at least 20 mm between the nearest Amplifier Unit and the Mobile Console head.

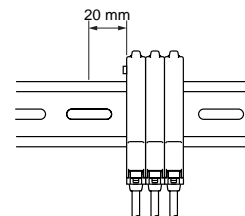

● **Fiber Connection**

The E3X Amplifier Unit has a lock button for easy connection of the Fiber Unit. Connect or disconnect the fibers using the following procedures:

1. Connection

Open the protective cover, insert the fibers according to the fiber insertion marks on the side of the Amplifier Unit, and lower the lock button.

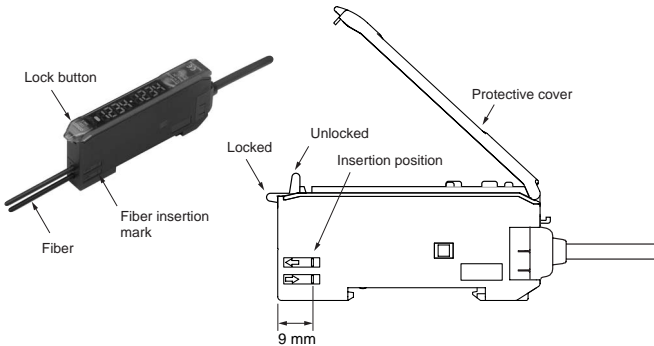

Fibers with E39-F9 Attachment

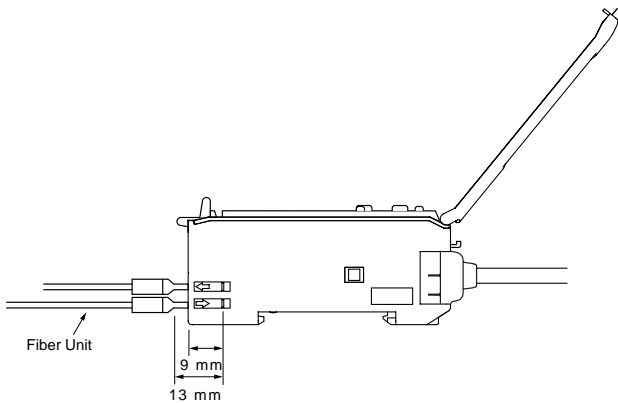

Fibers That Cannot Be Free-Cut (with Sleeves)

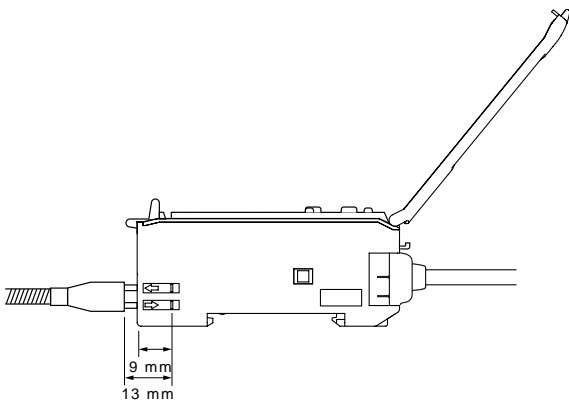

2. Disconnecting Fibers

Remove the protective cover and raise the lock button to pull out the fibers.

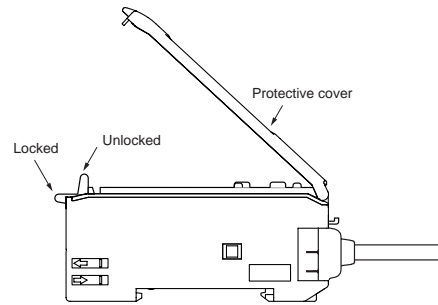

Note 1. To maintain the fiber properties, confirm that the lock is released before removing the fibers.

2. Be sure to lock or unlock the lock button within an ambient temperature range between -10°C and 40°C.

Adjustments

● **Mutual Interference Protection Function**

There may be some instability in the digital display values due to light from other sensors. If this occurs, decrease the sensitivity (i.e., decrease the power or increase the threshold) to perform stable detection.

● **EEPROM Writing Error**

If the data is not written to the EEPROM correctly due to a power failure or static-electric noise, initialize the settings with the keys on the Amplifier Unit. ERR/EEP will flash on the display when a writing error has occurred.

● **Optical Communications**

Several Amplifier Units can be slid together and used in groups. Do not, however, slide the Amplifier Units or attempt to remove any of the Amplifier Units during operation.

Other Precautions

● **Protective Cover**

Always keep the protective cover in place when using the Amplifier Unit.

● **Mobile Console**

Use the E3X-MC11-S Mobile Console for the E3X-DA-S-series Amplifier Units. Other Mobile Consoles, such as the E3X-MC11, cannot be used.

Dimensions

Amplifier Units

Amplifier Units with Cables

- E3X-DA11-S
- E3X-DA41-S
- E3X-DAG11-S
- E3X-DAG41-S
- E3X-DAB11-S
- E3X-DAB41-S
- E3X-DA11RM-S
- E3X-DA41RM-S
- E3X-DA11TW-S
- E3X-DA41TW-S

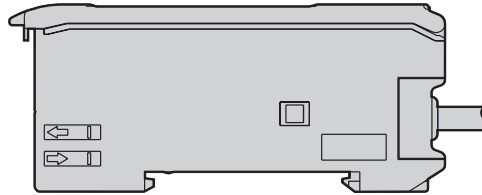
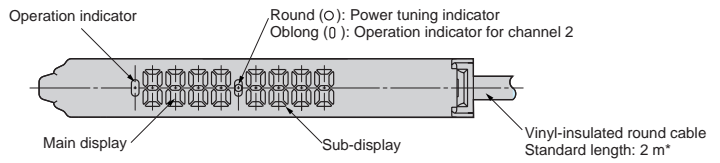

*Cable Specifications

E3X-DA11-S/DA41-S/DAG11-S/ DAG41-S/DAB11-S/DAB41-S	A 4-dia., 3-conductor (conductor cross-sectional area: 0.2 mm ² ; insulation diameter: 1.1 mm)
E3X-DA11TW-S/DA41TW-S/ DA11RM-S/DA41RM-S	A 4-dia., 4-conductor (conductor cross-sectional area: 0.2 mm ² ; insulation diameter: 1.1 mm)



With Mounting Bracket Attached

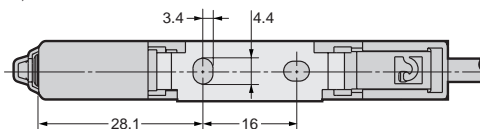
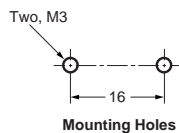
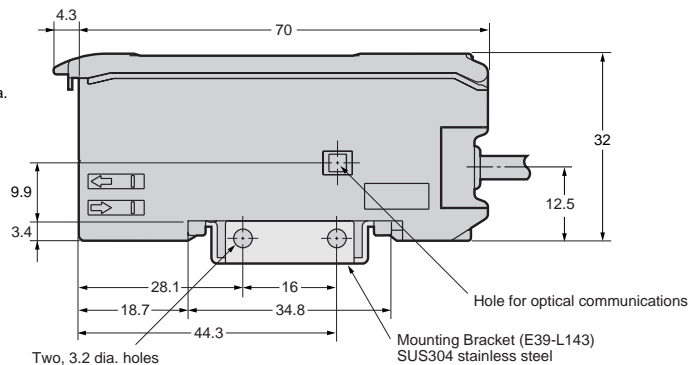
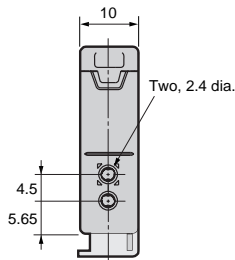
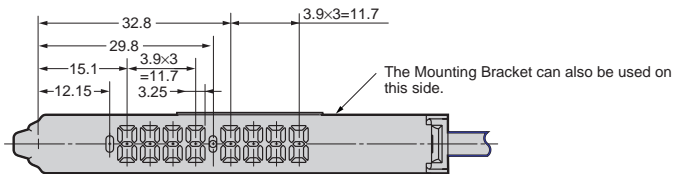

Amplifier Units with Connectors

E3X-DA6-S
 E3X-DA8-S
 E3X-DAG6-S
 E3X-DAG8-S
 E3X-DAB6-S
 E3X-DAB8-S
 E3X-DA6RM-S
 E3X-DA8RM-S
 E3X-DA6TW-S
 E3X-DA8TW-S

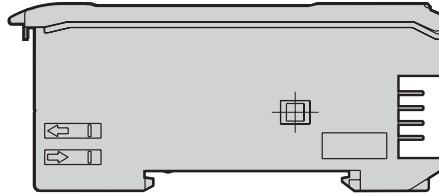
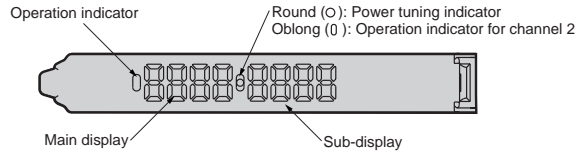

*1 The Mounting Bracket can also be used on this side.

*2 Cable Diameters

4.0-mm dia.	E3X-CN11 (3 conductors) E3X-CN21 (4 conductors) E3X-CN22 (2 conductors)
2.6-mm dia.	E3X-CN12 (1 conductor)

With Mounting Bracket Attached

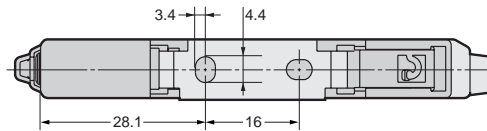
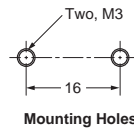
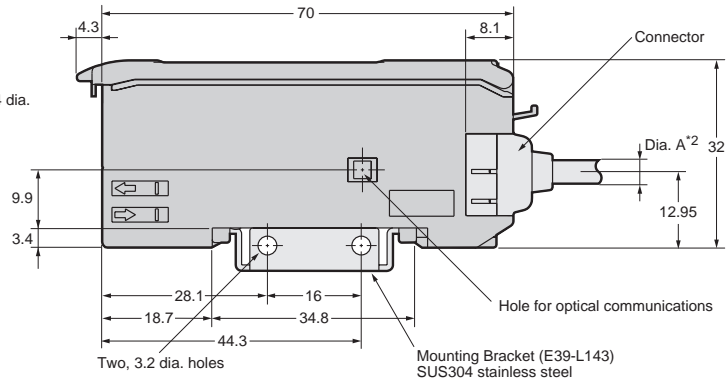
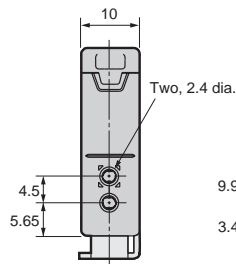
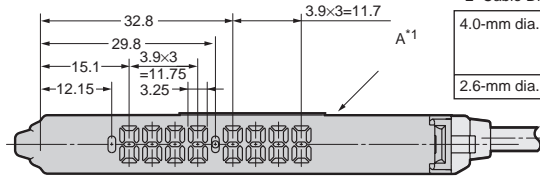

Amplifier Unit Connectors

Master Connectors

E3X-CN11
 E3X-CN21

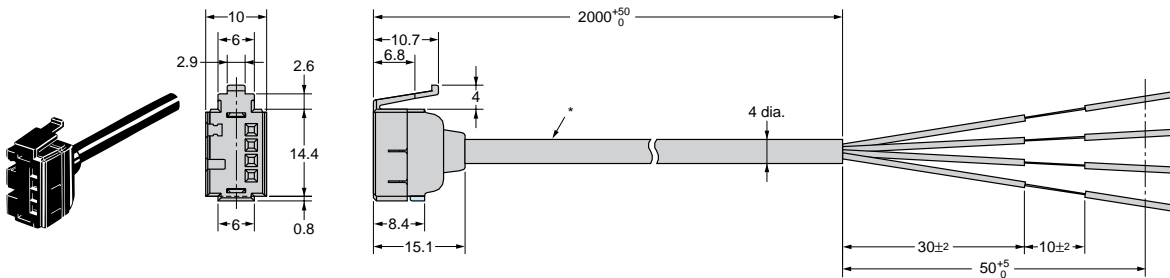

*E3X-CN11: A 4-dia., 3-conductor, vinyl-insulated round cable (conductor cross-sectional area: 0.2 mm²; insulation diameter: 1.1 mm) is used.

E3X-CN21: A 4-dia., 4-conductor, vinyl-insulated round cable (conductor cross-sectional area: 0.2 mm²; insulation diameter: 1.1 mm) is used.

Slave Connectors

E3X-CN12
E3X-CN22

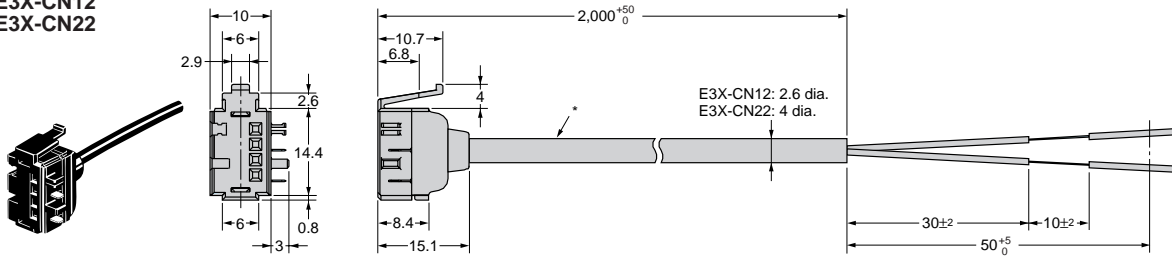

*E3X-CN12: A 2.6-dia., single-conductor, vinyl-insulated round cable (conductor cross-sectional area: 0.2 mm²; insulation diameter: 1.1 mm) is used.

E3X-CN22: A 4-dia., 2-conductor, vinyl-insulated round cable (conductor cross-sectional area: 0.2 mm²; insulation diameter: 1.1 mm) is used.

Mobile Console

E3X-MC11-S

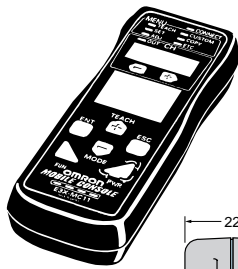

Mobile Console

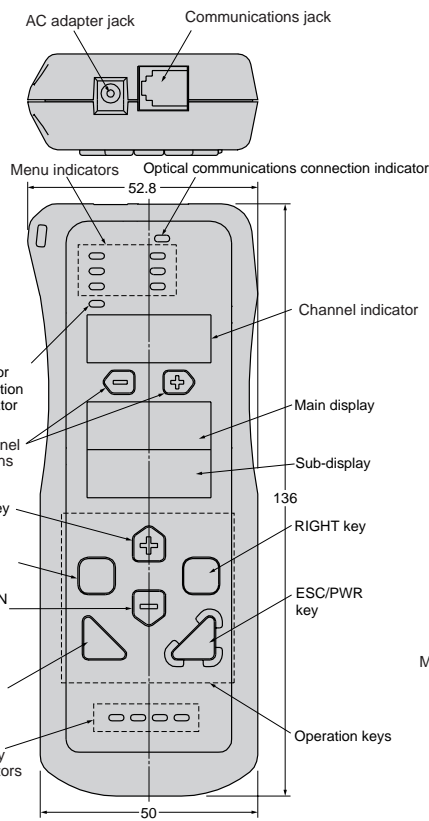

Mobile Console Head

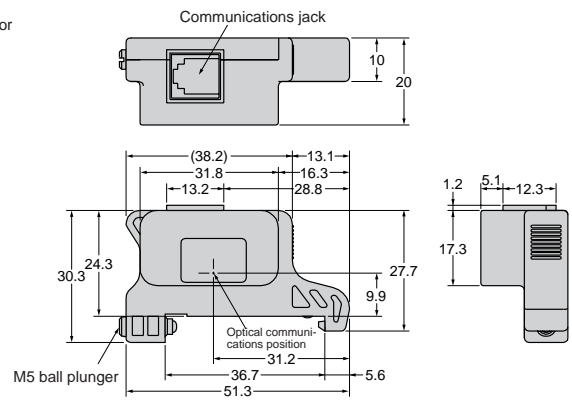
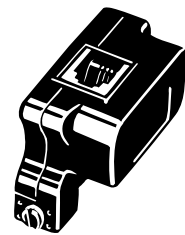

ALL DIMENSIONS SHOWN ARE IN MILLIMETERS.

To convert millimeters into inches, multiply by 0.03937. To convert grams into ounces, multiply by 0.03527.

Cat. No. E336-E1-01 **In the interest of product improvement, specifications are subject to change without notice.**

OMRON Corporation

Industrial Automation Company

Application Sensors Division

Sensing Devices and Components Division H.Q.

Shiokoji Horikawa, Shimogyo-ku,

Kyoto, 600-8530 Japan

Tel: (81)75-344-7068/Fax: (81)75-344-7107

Printed in Japan

0103-2M (0103) (O)