

Distinctive Characteristics

Guide interlocked with actuator block prevents window locking and maintains correct plunger alignment to assure contact stability.

Employs an over-center actuator mechanism, which diminishes sparking and increases operating life in AC circuits.

High torque bushing construction prevents rotation or separation from frame during installation.

Splashproof option (D3 and B3 bushing codes) features an o-ring within the bushing and one under the face nut to protect from splashed, sprayed, or spilled liquids.

High insulating barriers, formed in the molded diallyl phthalate case, increase isolation of circuits in multipole devices.

Prominent external insulating barriers increase insulation resistance and dielectric strength.

Epoxy sealed terminals prevent entry of solder flux and other contaminants.

Clinching of the frame to the case well above the base and terminals provides 1,500V dielectric strength.

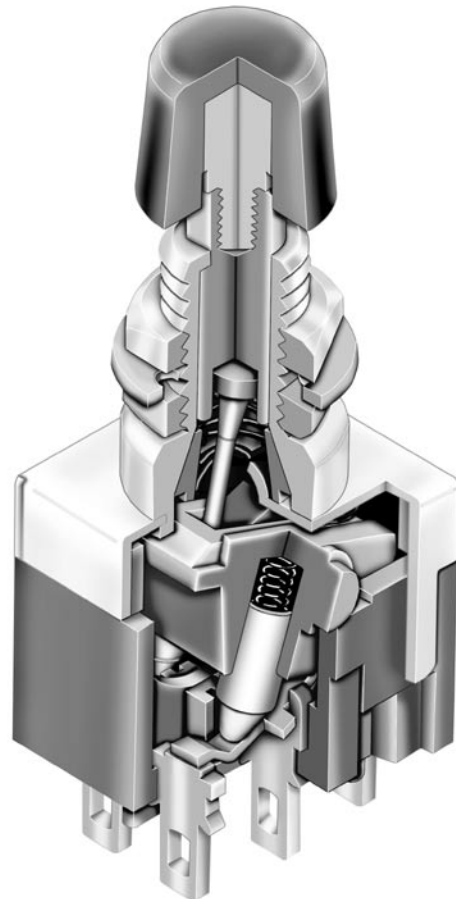

Actual Size

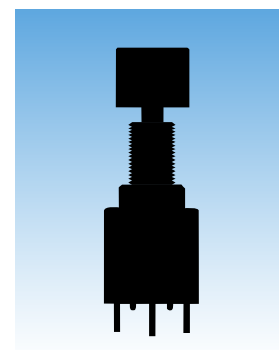

General Specifications

Electrical Capacity (Resistive Load)

Power Level (code W):	6A @ 125V AC & 3A @ 250V AC or 3A @ 30V DC
Logic Level (code G):	0.4VA maximum @ 28V AC/DC maximum (Applicable Range 0.1mA ~ 0.1A @ 20mV ~ 28V)
Logic/Power Level (code A):	Combines W & G ratings

Note: Find additional explanation dual rating & operating range in Supplement section.

Other Ratings

Contact Resistance:	10 milliohms maximum for silver; 20 milliohms maximum for gold		
Insulation Resistance:	1,000 megohms minimum @ 500V DC		
Dielectric Strength:	1,000V AC minimum between contacts for 1 minute minimum; 1,500V AC minimum between contacts & case for 1 minute minimum		
Mechanical Life:	50,000 operations minimum for splashproof models; 100,000 for all other models		
Electrical Life:	25,000 operations minimum for silver; 50,000 operations minimum for gold 50,000 operations minimum for silver at 3A @ 125V AC		
Nominal Operating Force:	Momentary Action: 1-pole 9.32N; 2-pole 16.18N; 4-pole 25.54N; Alternate Action: 1-pole 4.41N; 2-pole 7.06N; 4-pole 11.77N		
Contact Timing:	Slow make, slow break		
Plunger Travel:	Screw-on Cap (Mom.)	Screw-on Cap (Alt.)	Snap-on Cap (Mom. & Alt.)
Pretravel:	.028" (0.71mm)	.110" (2.80mm)	.125" (3.19mm)
Overtravel:	.043" (1.09mm)	.043" (1.10mm)	.050" (1.26mm)
Total Travel	.071" (1.80mm)	.153" (3.90mm)	.175" (4.45mm)

Materials & Finishes

Plunger:	Brass w/nickel plating; polyacetal w/B1 bushing	Bushing:	Brass with nickel plating
Frame:	Stainless steel	Case:	Diallyl phthalate resin (UL94V-0)
Movable Contactor:	Phosphor bronze with silver or gold plating		
Movable Contacts:	Silver alloy (code W); copper with gold plating (code G); or silver alloy with gold plating (code A)		
Stationary Contacts:	Silver with silver plating (code W); copper or brass with gold plating (code G); or silver with gold plating (code A)		
Terminals:	Copper or brass with silver plating; copper or brass with gold plating		

Environmental Data

Operating Temp Range:	-30°C through +85°C (-22°F through +185°F)
Humidity:	90 ~ 95% humidity for 96 hours @ 40°C (104°F)
Vibration:	10 ~ 55Hz with peak-to-peak amplitude of 1.5mm traversing the frequency range & returning in 1 minute; 3 right angled directions for 2 hours
Shock:	50G (490m/s ²) acceleration (tested in 6 right angled directions, with 5 shocks in each direction)
Sealing:	B3 & D3 bushing options equivalent to IP67

Installation

Mounting Torque:	1.5Nm (13.0 lb•in) for double nut; .7Nm (6.0 lb•in) for single nut
Cap Installation Force:	80.0N (18.0 lbf) maximum downward force on actuator
Soldering Time & Temp:	Wave Soldering (PC version): See Profile A in Supplement section. Manual Soldering: See Profile A in Supplement section.
Process Seal:	These devices are not process sealed. Hand clean locally using alcohol based solution.

Standards & Certifications

Flammability Standards:	UL94V-0 case
UL & C-UL Recognized:	All models recognized at 6A @ 125V AC or 3A @ 250V AC or 0.4VA max. @ 28V DC max; UL File No. WOYR2.E44145; add "/U" to end of part number to order UL mark on switch C-UL File No. WOYR8.E44145; add "/C-UL" to end of part number to order C-UL mark on switch
CSA Certified:	All models certified at 6A @ 125V AC or 3A @ 250V AC or 0.4VA max. @ 28V max; CSA File No. 023535-0-000; add "/C" to end of part number to order CSA mark on switch.



TYPICAL SWITCH ORDERING EXAMPLE

MB

2011

S

B1

W

01

D

A

POLES & CIRCUITS

2011	SPDT	ON	(ON)
2065	SPDT	ON	ON
2061	DPDT	ON	(ON)
2085	DPDT	ON	ON
2181	4PDT	ON	(ON)
2185	4PDT	ON	ON

() = Momentary

CONTACT MATERIALS & RATINGS

W	Silver Rated 6A @ 125V AC & 3A @ 250V AC
G	Gold Rated 0.4VA max @ 28V AC/DC max

CAPS

B	.315" (8.0mm) Dia.
C	.394" (10.0mm) Dia.
D	.520" (13.2mm) Dia.
E	.748" (19.0mm) Dia.

PLUNGER TYPE

S	Plunger for Screw-on Caps
----------	---------------------------

TERMINALS

01	Solder Lug
02	Quick Connect
03	.250" (6.35mm) Straight PC
05	.425" (10.8mm) Wirewrap
06	.750" (19.05mm) Wirewrap
07	.964" (24.5mm) Wirewrap
08	1.062" (27.0mm) Wirewrap

CAP COLORS

A	Black
B	White
C	Red
*D	Amber
*E	Yellow
F	Green
*G	Blue
*H	Gray

* Not available with cap code E

BUSHINGS

B1	.472" (12.0mm) Threaded with Keyway
B3	.472" (12.0mm) Threaded w/Splashproof

IMPORTANT:



Switches are supplied without UL, C-UL, & CSA markings unless specified. Specific models & ratings noted on General Specifications page.

DESCRIPTION FOR TYPICAL ORDERING EXAMPLE

MB2011SB1W01-DA

Black .520" (13.2mm) Diameter Cap



Plunger for Screw-on Caps





.472" (12.0mm) Diameter
Threaded Bushing with Keyway

Silver Contacts with
6-Amp Rating

SPDT ON-(ON) Circuit

Solder Lug Terminals

POLES & CIRCUITS

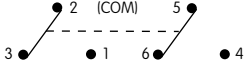
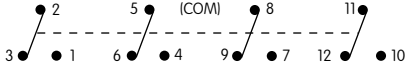
Pole	Model	Plunger Position () = Momentary		Connected Terminals		Throw & Switch Schematics
		Normal  Keyway	Down 	Normal  Keyway	Down 	
SP	MB2011 MB2065	ON ON	(ON) ON	2-3	2-1	SPDT 
DP	MB2061 MB2085	ON ON	(ON) ON	2-3 5-6	2-1 5-4	DPDT 
4P	MB2181 MB2185	ON ON	(ON) ON	2-3 5-6 8-9 11-12	2-1 5-4 8-7 11-10	4PDT 

Note: Terminal numbers are not actually on the switch.

PLUNGER TYPE

S

Plunger for Screw-on Caps
Plunger is plastic for B1 bushing.

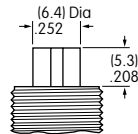

Plunger is metal for B3 bushing.

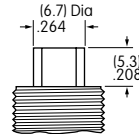

On alternate action models, after transferring circuit, the plunger returns to its original position, and does not latch down.

BUSHINGS

B1

.472" (12.0mm) Diameter Threaded with Keyway

Maximum Panel Thickness with Standard Hardware: .217" (5.5mm)

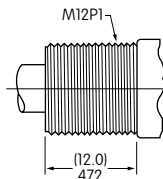
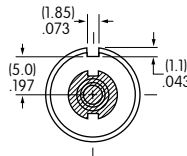

B3

.472" (12.0mm) Diameter Threaded Splashproof

Maximum Panel Thickness with Standard Hardware: .217" (5.5mm)

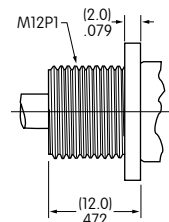
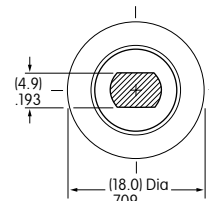

Panel Cutouts

For B1 Bushing with Keyway

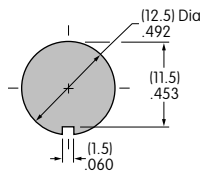

For B1 Bushing with Optional Locking Ring

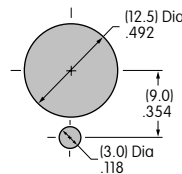

For B3 Bushing without Keyway

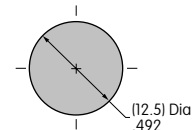

CONTACT MATERIALS & RATINGS

W

Silver over Silver

Power Level

6A @ 125V AC & 3A @ 250V AC

G

Gold over Brass or Copper

Logic Level

0.4VA maximum @ 28V AC/DC maximum

Note: Complete explanation of operating range in Supplement section.

TERMINALS

01 Solder Lug

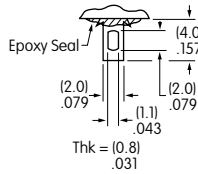

02 .062" (1.57mm) Wide Quick Connect

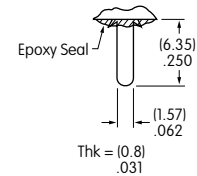

03 .250" (6.35mm) Straight PC

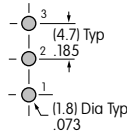
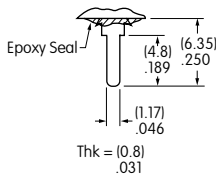

Single Pole

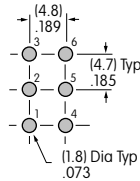

Double Pole

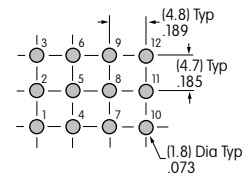

Four Pole

05 .425" (10.8mm) Wirewrap or Extended PC

06 .750" (19.05mm) Wirewrap or Extended PC

07 .964" (24.5mm) Wirewrap or Extended PC

08 1.062" (27.0mm) Wirewrap or Extended PC

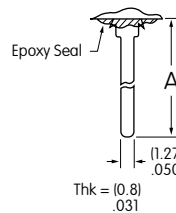

If using as extended PC terminal, refer to the above footprints.

Dimension A = terminal lengths as shown beside the terminal codes at the left.

CAPS & CAP COLORS

B AT078 .315" (8.0mm) Dia. Screw-on Cap

Material: Polystyrene
Finish: Glossy



Colors Available: A B C E F G H

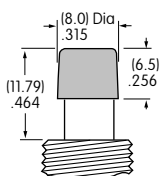

C AT079 .394" (10.0mm) Dia. Screw-on Cap

Material: Polystyrene
Finish: Glossy



Colors Available: A B C E F G H

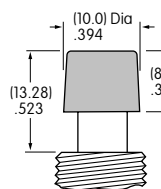

D AT414 .520" (13.2mm) Dia. Screw-on Cap

Material: PBT
Finish: Glossy



Colors Available: A B C D E F G H

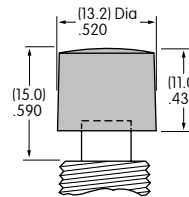

E AT412 .748" (19.0mm) Dia. Screw-on Cap

Material: Polystyrene
Finish: Glossy



Colors Available: A B C F

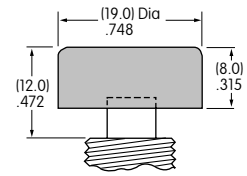

Cap Color Codes:

- A Black
 B White
 C Red
 D Amber
 E Yellow
 F Green
 G Blue
 H Gray

TYPICAL SWITCH DIMENSIONS

Solder Lug

Single Pole

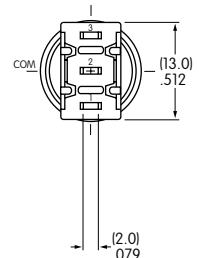
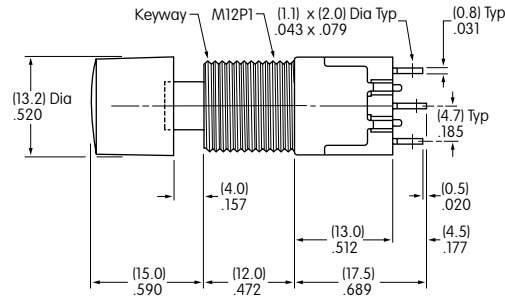
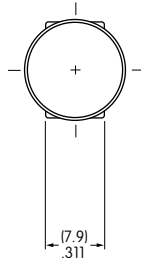

MB2011SB1W01-DA

Solder Lug

Double Pole

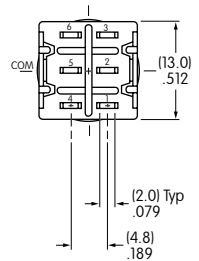
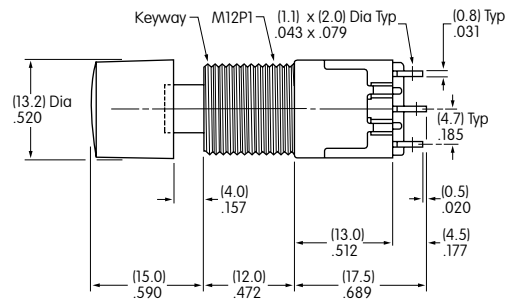
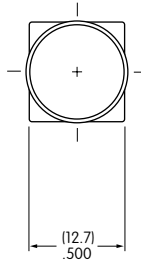

MB2061SB1W01-DA

Solder Lug

Four Pole

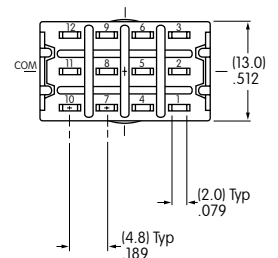
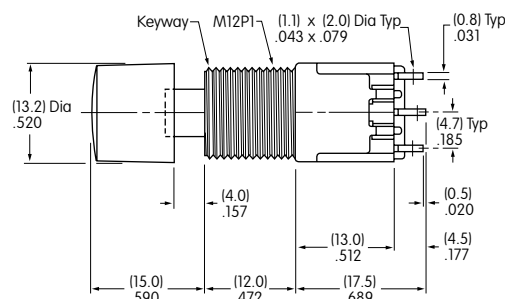
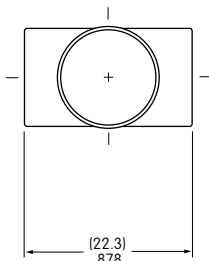

MB2181SB1W01-DA

HARDWARE

Standard Hardware for B1 Bushing

AT503M Hex Face Nut

Material:
Brass with Chrome plating

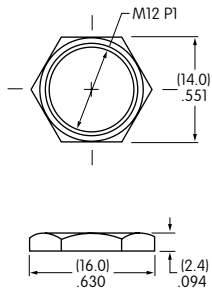

AT508 Lockwasher

Material:
Steel with Zinc/Chromate

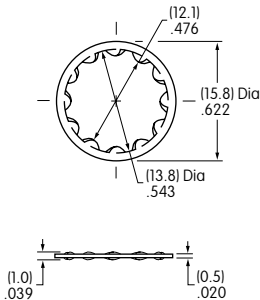

AT527M Hex Nut

Material:
Steel with Nickel plating

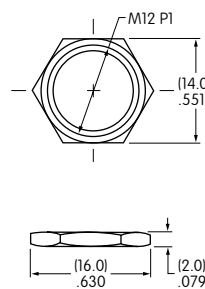

AT506M Locking Ring

Material:
Steel with Zinc/Chromate

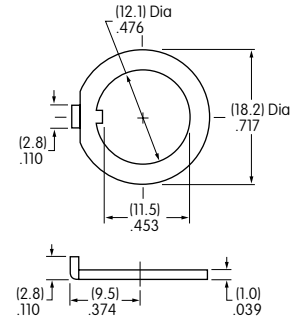

Standard Hardware for B3 Bushing

AT503M Hex Face Nut

Material:
Brass with Chrome plating

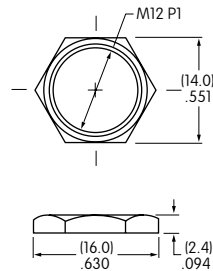

AT401P O-ring

Material:
Natural rubber

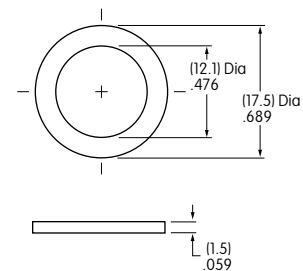

Optional Splashproof Boot for B1 Bushing

AT4043 Splashproof Boot

Material: Silicone Rubber
Operating Life: 10,000 for momentary
30,000 for alternate action

When using a splashproof boot, no cap is required.

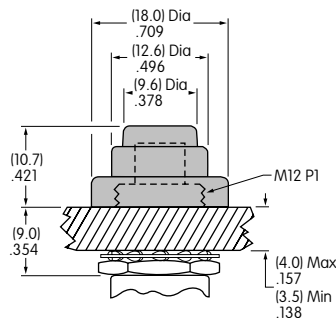

CUSTOM ASSEMBLY ORDERING EXAMPLE

The MB2000 pushbutton series offers flexibility to accommodate a variety of applications. Using a basic large bushing model, different accessories can be assembled onto the switch to achieve the mounting variations shown on the following two pages.

- These switches have:
- 12mm diameter threaded bushing with keyway
 - Silver contacts
 - 6-Amp rating
 - Solder lug terminals

Other 12mm bushing options can be used; see details in preceding Large Bushing Ordering tables.

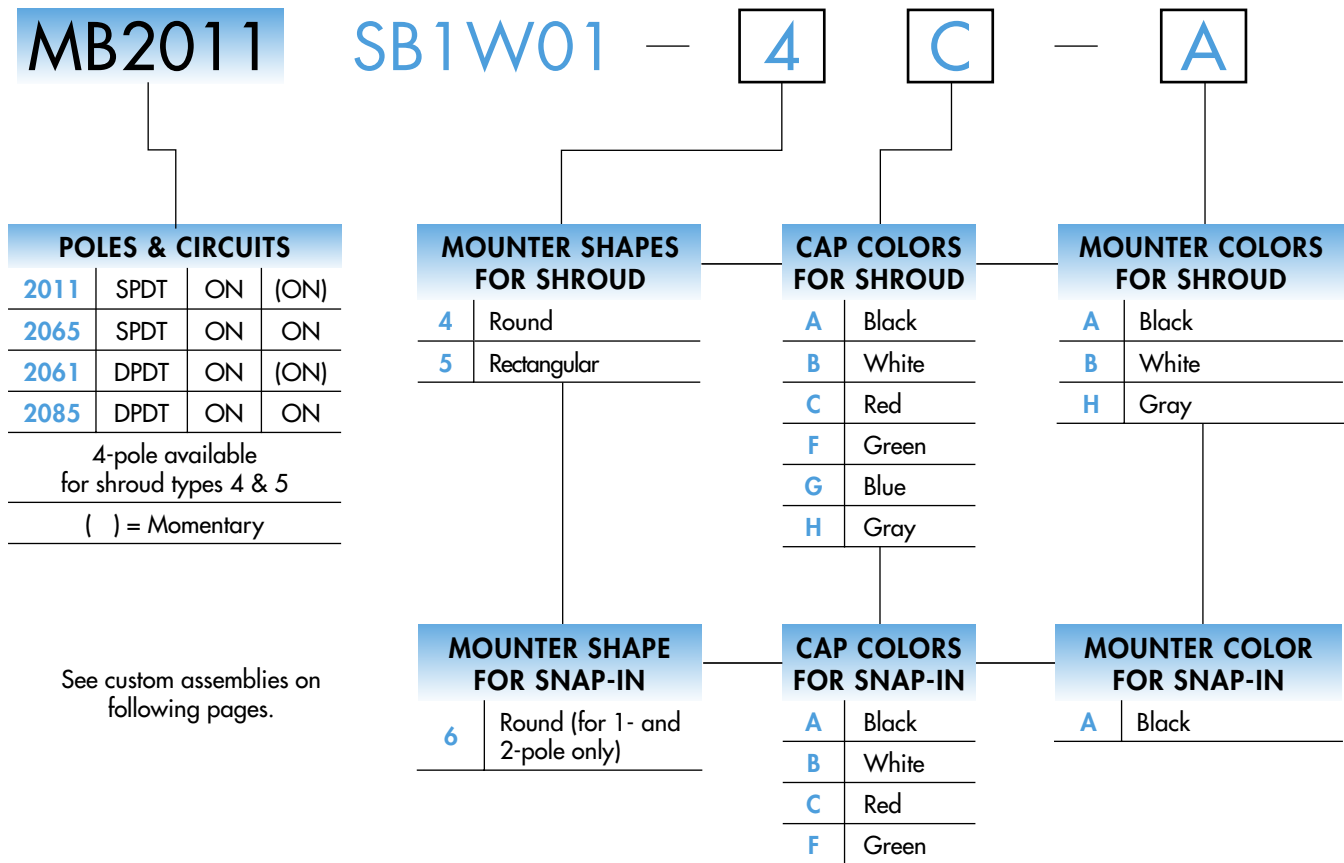

Round Shroud
MB2011SB1W01-4C-A



Rectangular Shroud
MB2011SB1W01-5C-A



Snap-in Mounter
MB2011SB1W01-6C-A

MOUNTER SHAPES FOR SHROUDS

4 AT455 Round

Material: Polycarbonate

Colors: A B H



5 AT453 Rectangular

Material: Polycarbonate

Colors: A B H



CAPS & CAP COLORS FOR SHROUDS

AT454 Round Insert Cap

Material: Polycarbonate

Colors: A B C F G H



AT452 Rectangular Insert Cap

Material: Polycarbonate

Colors: A B C F G H



AT080 Screw Adaptor for Insert Caps

Material: Brass



MOUNTER SHAPE FOR SNAP-IN

6 AT528 Round

Material: Glass fiber reinforced polyamide

Color: A



CAP & CAP COLORS FOR SNAP-IN MOUNTER

AT412 Screw-on Cap

Material: Polystyrene

Colors: A B C F



Color Codes:



Black



White



Red



Green



Blue



Gray

CUSTOM ASSEMBLY WITH ROUND SHROUD



MB2011SB1W01-4C-A

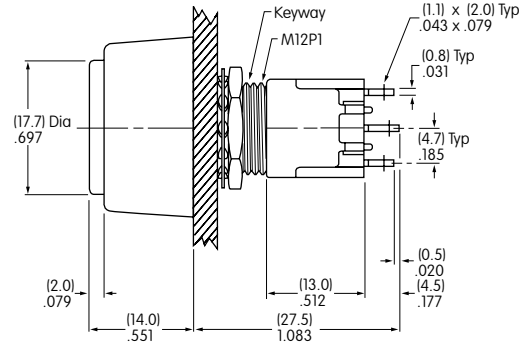
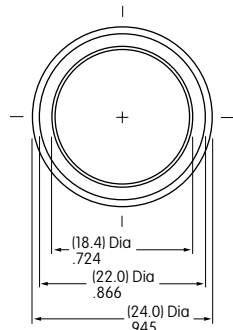

Single Pole

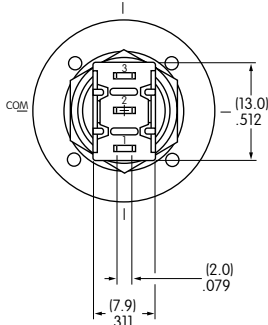

Double Pole

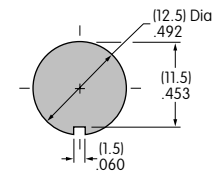
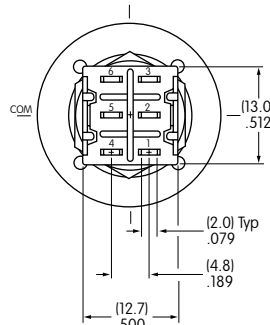

Effective Panel Thickness:
.217" (5.5mm) maximum

CUSTOM ASSEMBLY WITH RECTANGULAR SHROUD



MB2011SB1W01-5C-A

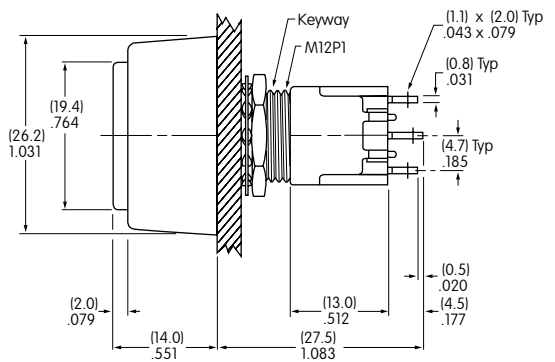
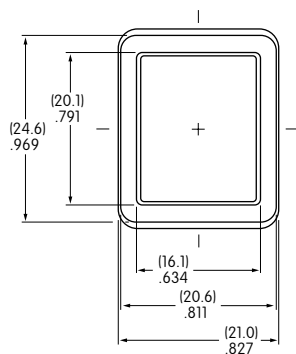

Single Pole

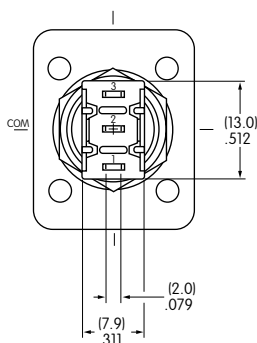

Double Pole

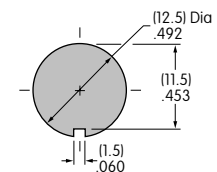
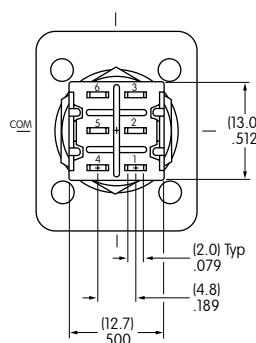

Effective Panel Thickness:
.217" (5.5mm) maximum

CUSTOM ASSEMBLY WITH SNAP-IN MOUNTER



MB2011SB1W01-6C-A

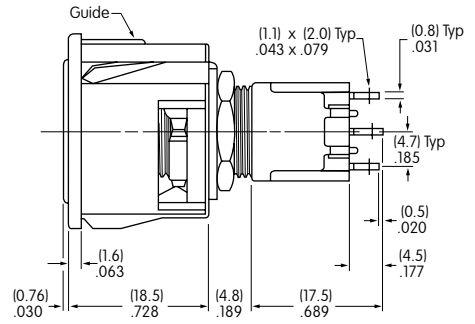
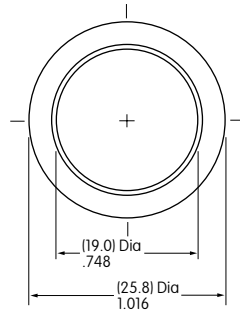

Single Pole

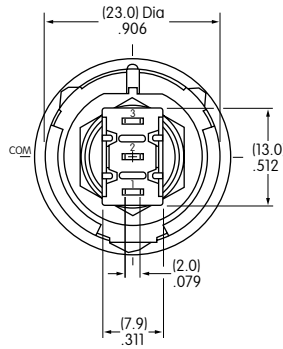

Double Pole

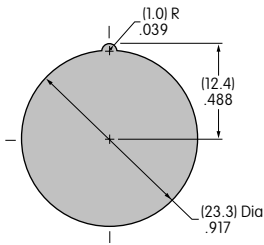
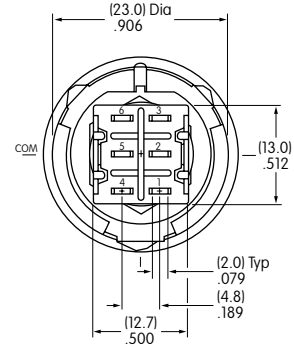

Panel Thickness Range:
.039" ~ .157" (1.0 ~ 4.0mm)