

Miniature Square Photoelectric Sensor in plastic housing

E3T

- Ultra flat size with high power pinpoint LED where space is crucial
- 3.5 mm thin flat shape
- IP67
- Pulse synchronisation for high ambient light immunity



Features

Flat background suppression (BGS) with highest repeatability even for differently colored objects.

Minimal black white error

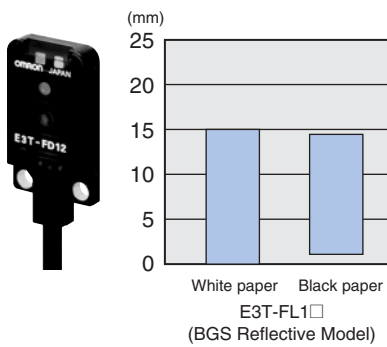

Unique light receiving lens shape for high precision alignment

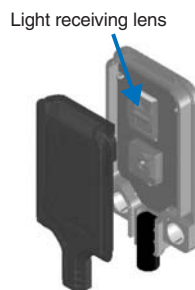

New mounting technology for reliable background suppressions in 3.5 mm flat housing

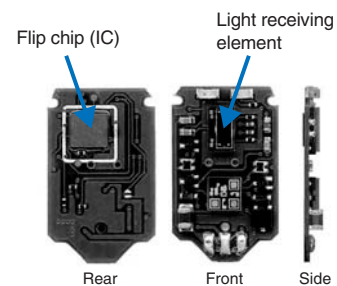

Application

E3T-ST Through-beam (Side View) Models/E3T-FT Through-beam (Flat) Models

- Long-distance detection Side-view Models: 1m, Flat Models: 500 mm.
- Minimum detection object: 0.5 mm dia. (with slit attached).
- Optical axis accuracy of $\pm 2^\circ$ for high installation reliability.

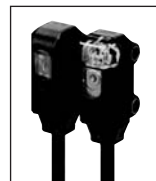

Application

E3T-SL Convergent-reflective Models (Side-view)

- Minimum detection object: 0.15 mm dia.
- Resistant to background and surrounding metal.



E3T-FD Diffuse-reflective Models (Flat)



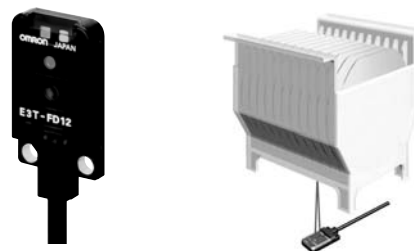





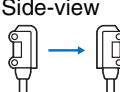

- Minimum detection object: 0.15 mm dia.
- Only 3.5 mm wide for installation in small gaps.

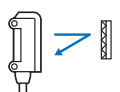

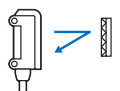
Ordering Information

Sensors

Red light

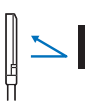
Sensing method	Appearance		Connection method	Sensing distance	Operation mode	Model *1	
						NPN output	PNP output
Through-beam	 Side-view	 Side-view	Pre-wired	1 m	Light-ON	E3T-ST11 *2	E3T-ST13
				(Sensitivity Adjustment Unit can be used.)	Dark-ON	E3T-ST12 *2	E3T-ST14
				300 mm	Light-ON	E3T-ST21	E3T-ST23
				Dark-ON	E3T-ST22	E3T-ST24	
	500mm	Light-ON		E3T-FT11 *2	E3T-FT13		
	Dark-ON	E3T-FT12		E3T-FT14			
	300 mm	Light-ON		E3T-FT21	E3T-FT23		
	Dark-ON	E3T-FT22		E3T-FT24			
Retro-reflective	 Side-view	 Side-view	200mm [10mm]	Light-ON	E3T-SR21 *2	E3T-SR23	
			Dark-ON	E3T-SR22 *2	E3T-SR24		
	 Side-view	 Side-view	100 mm [10 mm]	Light-ON	E3T-SR31 *2	E3T-SR33	
			Dark-ON	E3T-SR32 *2	E3T-SR34		
Diffuse-reflective	 Flat	 Flat	*3	5 to 30 mm	Light-ON	E3T-FD11 *2	E3T-FD13
				Dark-ON	E3T-FD12 *2	E3T-FD14	
Convergent-reflective	 Side-view	 Side-view	*3	5 to 15 mm	Light-ON	E3T-SL11 *2	E3T-SL13
				Dark-ON	E3T-SL12 *2	E3T-SL14	
				5 to 30 mm	Light-ON	E3T-SL21 *2	E3T-SL23
				Dark-ON	E3T-SL22 *2	E3T-SL24	
BGS reflective	 Flat	 Flat	*3	1 to 15 mm	Light-ON	E3T-FL11 *2	E3T-FL13
				Dark-ON	E3T-FL12 *2	E3T-FL14	
				1 to 30 mm	Light-ON	E3T-FL21 *2	E3T-FL23
				Dark-ON	E3T-FL22 *2	E3T-FL24	

*1. Please contact your OMRON representative for models with M8 junction connectors.

*2. A Robotics Cable is provided. These models have an R suffix. (Example: E3T-ST11R). Models with e-CON connector are available.

*3. Values in parentheses indicate the minimum required distance between the Sensor and Reflector.

Accessories (Order Separately)

Slits

Slit width	Sensing distance (typical)	Minimum detectable object (typical)	Model	Quantity	Remarks
0.5 mm dia.	100 mm	0.5 mm dia.	E39-S63	One each for Emitter and Receiver; common with Slit widths of 1 dia. and 0.5 dia. (total of 2)	Plug-in type round slits Can be used with E3T-ST1□ Through-beam Models.
1 mm dia.	300 mm	1 mm dia.			
0.5 mm dia.	50 mm	0.5 mm dia.	E39-S64		Plug-in type round slits Can be used with E3T-FT1□ Through-beam Models.
1 mm dia.	100 mm	1 mm dia.			

Reflectors





Name	Sensing distance (Sensor model)	Minimum detectable object (typical)	Model	Quantity	Remarks
Small Reflectors	200 mm (10 mm) *1 (E3T-SR2□)	2 mm dia.	E39-R4	1	Provided with the E3T-SR2□ Retro-reflective Models.
	100 mm (10 mm) *1 (E3T-SR3□)		E39-R37		Provided with the E3T-SR3□ Retro-reflective Models.

*1. Values in parentheses indicate the minimum required distance between the Sensor and Reflector.

Sensitivity Adjustment Unit

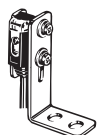
Appearance	Sensing distance (typical)	Model	Quantity	Remarks
	300 to 800 mm	E39-E10	1	Can be used with the E3T-ST1□ Through-beam Models.

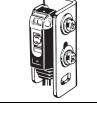
Mounting Brackets

Appearance	Model	Quantity	Remarks
	E39-L116	1	Can be used with the E3T-S□□□ Side-view Models. (A securing nut plate is provided with the Mounting Bracket.)
	E39-L117		
	E39-L118		
	E39-L119		Can be used with the E3T-F□□□ Flat Models.
	E39-L120		

Note: When using Through-beam models, order one bracket for the Receiver and one for the Emitter.

Sensor I/O Connectors

Size	Cable type	Shape	Cable length	Model	
e-CON	Standard cable	Connector on one end	2 m	4-wire	E39-ECON2M
			5 m		E39-ECON5M
		Connector on both ends	0.5 to 1 m	E39-ECONW□M Replace □ with the cable length in 0.1 m increments.	
			1.1 to 1.5 m		
			1.6 to 2 m		

Rating and Specifications

Sensing method	Through-beam				Retro-reflective			
	Side-view		Flat		Side-view			
	NPN	PNP	NPN	PNP	NPN	PNP	NPN	PNP
	E3T-ST11 E3T-ST12 E3T-ST21 E3T-ST22	E3T-ST13 E3T-ST14 E3T-ST23 E3T-ST24	E3T-FT11 E3T-FT12 E3T-FT21 E3T-FT22	E3T-FT13 E3T-FT14 E3T-FT23 E3T-FT24	E3T-SR21 E3T-SR22	E3T-SR23 E3T-SR24	E3T-SR31 E3T-SR32	E3T-SR33 E3T-SR34
Sensing distance	E3T-ST1□ 1 m E3T-ST2□ 300 mm	E3T-FT1□ 500 mm E3T-FT2□ 300 mm	E3T-SR2□200 mm (10 mm) *1 (with the E39-R4)	E3T-SR3□100 mm (10 mm) *1 (with the E39-R37)				
Standard sensing object	Opaque, 2 mm dia. min.		Opaque, 1.3 mm dia. min.		Opaque, 27 mm dia. min.			
Minimum detectable object (typical)	2 mm dia opaque object		1.3 mm dia opaque object		2 mm dia. (sensing distance of 100 mm)			
Hysteresis (white paper)	---							
Black/white error	---							
Directional angle	Emitter: 2° to 20° Receiver: 2° to 70°		Emitter: 3° to 25° Receiver: 3° min.		2° to 20°			
Light source (wavelength)	Red LED ("Pin-point" LED) λ = 650 nm							
Power supply voltage	12 to 24 VDC ±10%, ripple (p-p) 10% max.							
Current consumption	Emitter: 10 mA max. Receiver: 20 mA max.				20 mA max.			
Control output	Load power supply voltage: 26.4 VDC max. Load current: 50 mA max. (residual voltage: 2 V max. for load current of 10 to 50 mA, 1 V max. for load current of less than 10 mA) Open collector output Light ON: E3T-□□□1 and E3T-□□□3 Dark ON: E3T-□□□2 and E3T-□□□4							
Protection circuits	Power supply and control output reverse polarity protection Output short-circuit protection				Power supply and control output reverse polarity protection Output short-circuit protection, Mutual interference prevention			
Response time	Operate or reset: 1 ms max.							
Ambient illumination	Incandescent lamp: 5,000 lx max. Sunlight: 10,000 lx max.							
Ambient temperature range	Operating: -25 to 55 °C Storage: -40 to 70 °C (with no icing or condensation)							
Ambient humidity range	Operating: 35% to 85% Storage: 35% to 95% (with no condensation)							
Insulation resistance	20 MΩ min. at 500 VDC							
Dielectric strength	1,000 VAC, 50/60 Hz for 1 min							
Vibration resistance	Destruction: 10 to 2,000 Hz, 1.5 mm double amplitude or 300 m/s ² for 0.5 hrs each in X, Y, and Z directions							
Shock resistance	Destruction: 1,000 m/s ² 3 times each in X, Y, and Z directions							
Degree of protection	IP67 (IEC60529)							
Connection method	Pre-wired (standard length: 2 m)							
Weight	Approx. 40 g				Approx. 20 g			
Materials	Case	PBT (polybutylene terephthalate)						
	Display window	Denatured polyarylate						
	Lens	Denatured polyarylate				Methacrylic resin		
Accessories	Instruction manual, Installation screws (Side-view Models: M2 x 14, Flat Models: M2 x 8), Nuts, Spring washers, Flat washers, E39-R4 (E3T-SR2□ only), E39-R37 (E3T-SR3□ only)							

*1. Values in parentheses indicate the minimum required distance between Sensor and Reflector.

Sensing method	Diffuse-reflective		Convergent-reflective				BGS reflective			
	Flat		Side-view				Flat			
	NPN	PNP	NPN	PNP	NPN	PNP	NPN	PNP	NPN	PNP
	E3T-FD11 E3T-FD12	E3T-FD13 E3T-FD14	E3T-SL11 E3T-SL12	E3T-SL13 E3T-SL14	E3T-SL21 E3T-SL22	E3T-SL23 E3T-SL24	E3T-FL11 E3T-FL12	E3T-FL13 E3T-FL14	E3T-FL21 E3T-FL22	E3T-FL23 E3T-FL24
Sensing distance	5 to 30 mm (50 x 50 mm white paper)		5 to 15 mm (50 x 50 mm white paper)		5 to 30 mm (50 x 50 mm white paper)		1 to 15 mm (50 x 50 mm white paper)		1 to 30 mm (50 x 50 mm white paper)	
Standard sensing object	---									
Minimum detectable object (typical)	0.15 mm dia. (sensing distance of 10 mm)						0.15 mm dia non-glossy object (sensing distance of 10 mm)			
Hysteresis (white paper)	6 mm max.		2 mm max.		6 mm max.		0.5 mm max.		2 mm max.	
Black/white error	---								15% max.	
Directional angle	---									
Light source (wavelength)	Red LED ("Pin-point" LED) $\lambda = 650$ nm									
Power supply voltage	12 to 24 VDC $\pm 10\%$, ripple (p-p) 10% max.									
Current consumption	20 mA max.									
Control output	Load power supply voltage: 26.4 VDC max. Load current: 50 mA max. (residual voltage: 2 V max. for load current of 10 to 50 mA, 1 V max. for load current of less than 10 mA) Open-collector output Light ON: E3T-□□□1 and E3T-□□□3 Dark ON: E3T-□□□2 and E3T-□□□4									
Protection circuits	Power supply and control output reverse polarity protection Output short-circuit protection, Mutual interference prevention									
Response time	Operate or reset: 1 ms max.									
Ambient illumination	Incandescent lamp: 5,000 lx max. Sunlight: 10,000 lx max.									
Ambient temperature range	Operating: -25 to 55 °C Storage: -40 to 70 °C (with no icing or condensation)									
Ambient humidity range	Operating: 35% to 85% Storage: 35% to 95% (with no condensation)									
Insulation resistance	20 M Ω min. at 500 VDC									
Dielectric strength	1,000 VAC, 50/60 Hz for 1 min									
Vibration resistance	Destruction: 10 to 2,000 Hz, 1.5 mm double amplitude or 300 m/s ² for 0.5 hrs each in X, Y, and Z directions									
Shock resistance	Destruction: 1,000 m/s ² 3 times each in X, Y, and Z directions									
Degree of protection	IP67 (IEC60529)									
Connection method	Pre-wired (standard length: 2 m)									
Weight	Approx. 20 g									
Materials	Case	PBT (polybutylene terephthalate)								
	Display window	Denatured polyarylate								
	Lens	Denatured polyarylate								
Accessories	Instruction manual, Installation screws (Side-view Models: M2 x 14, Flat Models: M2 x 8), Nuts, Spring washers, Flat washers									

Engineering Data (Typical)

Parallel Operating Range

Through-beam

E3T-ST1□ + E39-S63 Slit
(Order Separately)

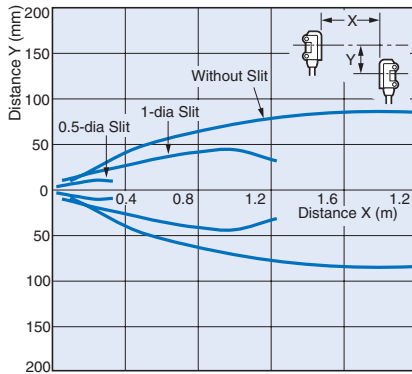

E3T-ST1□ + E39-S63 Slit
(Order Separately)(Enlarged graph)

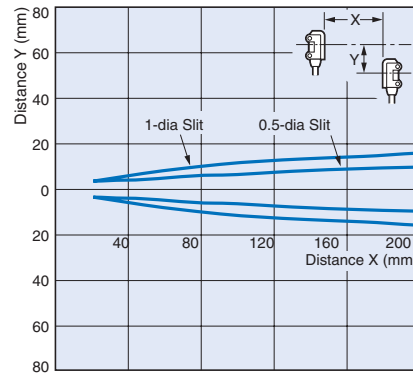

E3T-ST2□

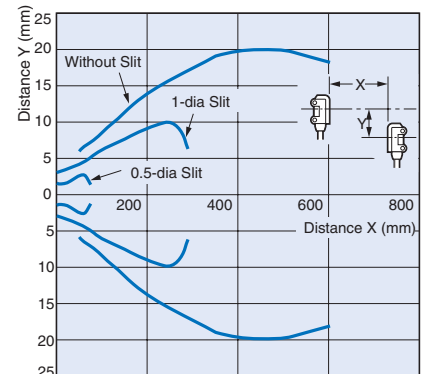

E3T-FT1□ + E39-S64 Slit
(Order Separately)

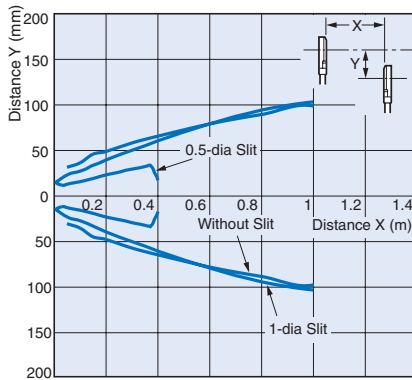

E3T-FT1□ + E39-S64 Slit
(Order Separately)(Enlarged graph)

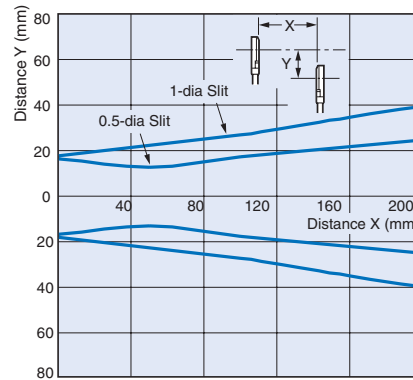

E3T-FT2□

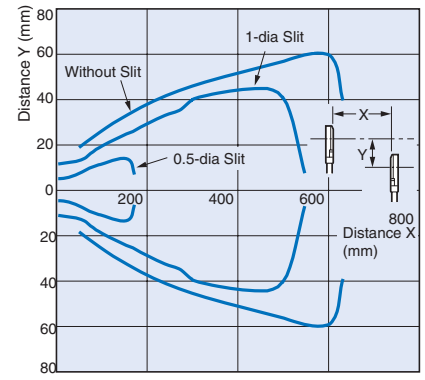

Through-beam

E3T-SR2□ + E39-R4 (Provided)

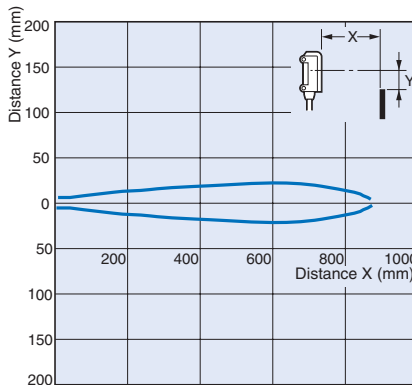

E3T-SR3□ + E39-R37 (Provided)

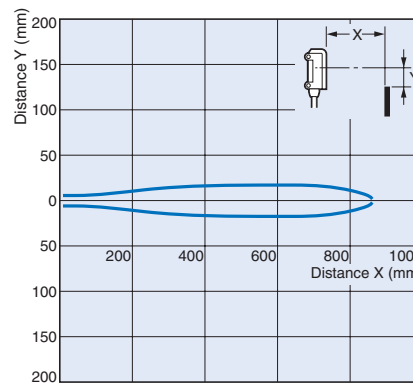

Operating Range

Diffuse-reflective

E3T-FD1□

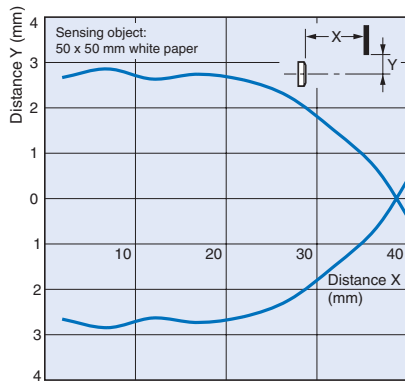

Convergent-reflective

E3T-SL1□

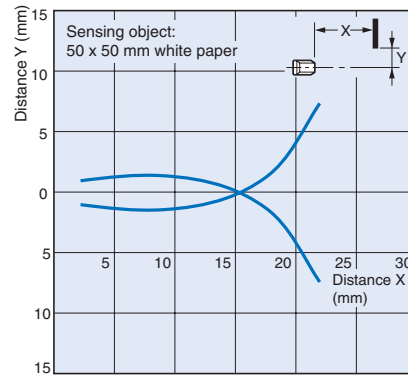

E3T-SL2□

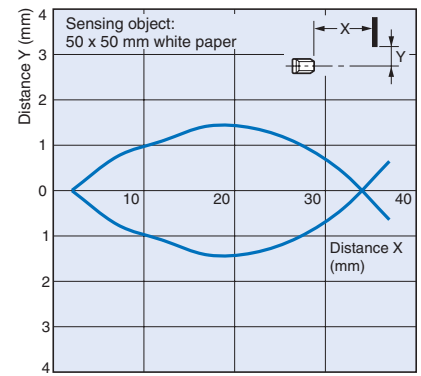

BGS Reflective

E3T-FL1□

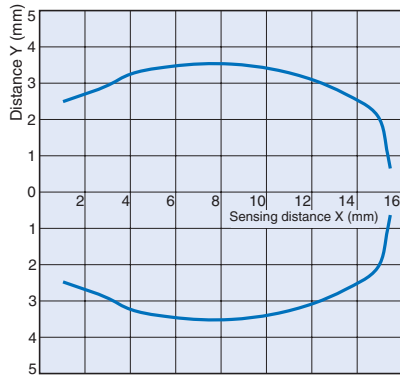

E3T-FL2□

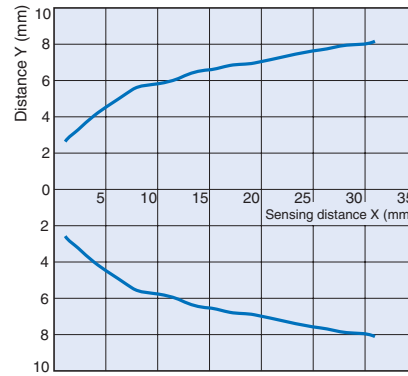

Inclination Characteristics

Convergent-reflective

E3T-SL1□ (Top to Bottom)

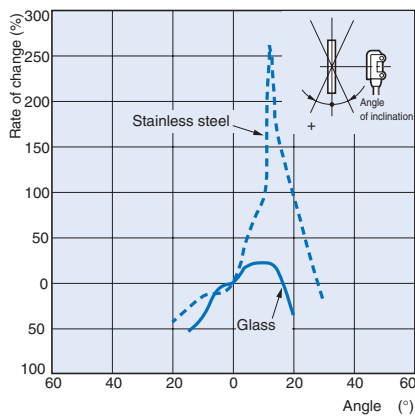

E3T-SL1□ (Right to Left)

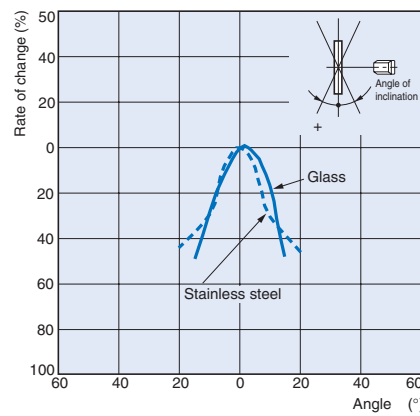

E3T-SL2□ (Top to Bottom)

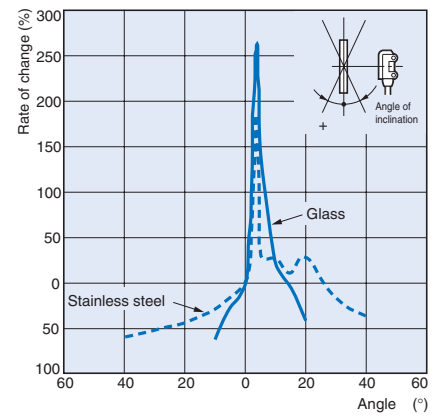

BGS Reflective

E3T-SL2□ (Right to Left)

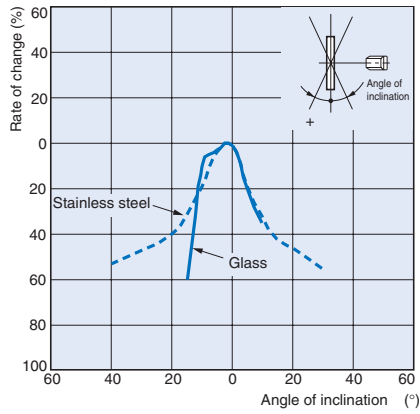

E3T-FL1□ (Top to Bottom)

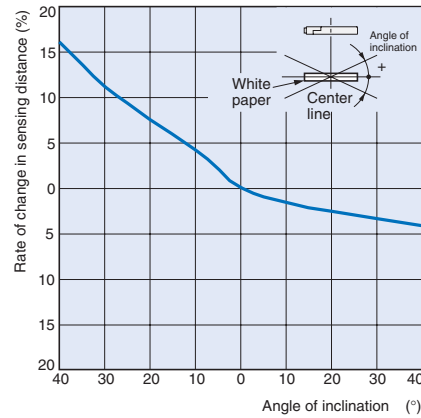

E3T-FL1□ (Right to Left)

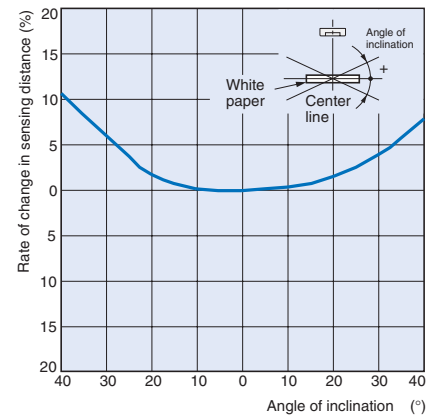

E3T-FL2□ (Top to Bottom)

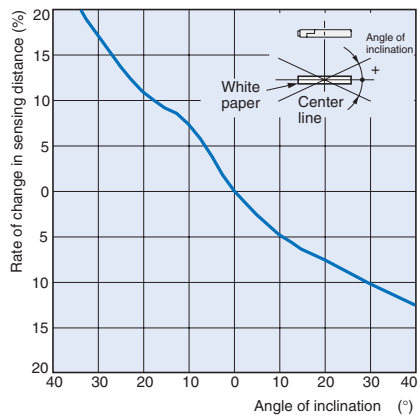

E3T-FL2□ (Right to Left)

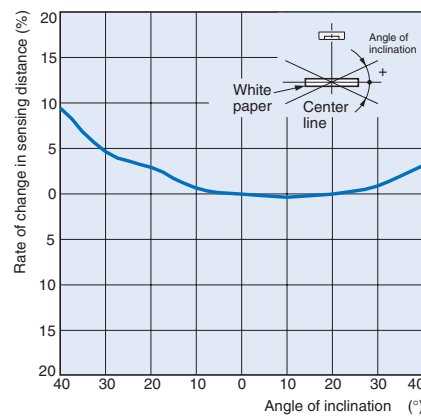

Excess Gain vs. Set Distance

Through-beam

E3T-ST1□

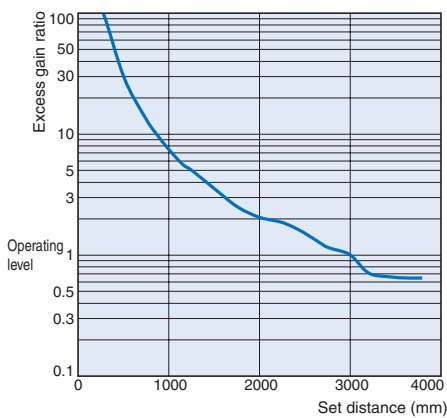

E3T-FT1□

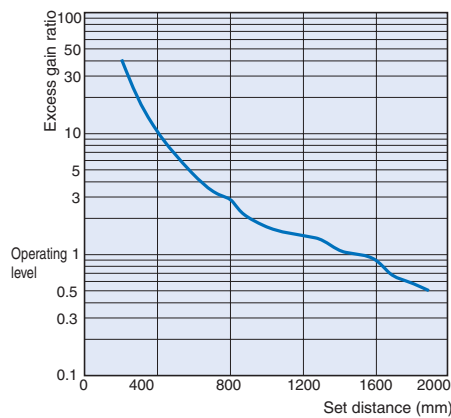

E3T-ST2□

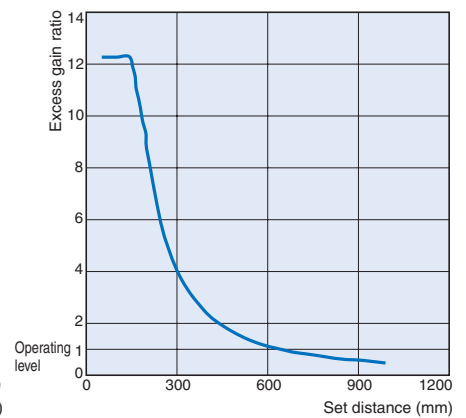

Retro-reflective

E3T-FT2□

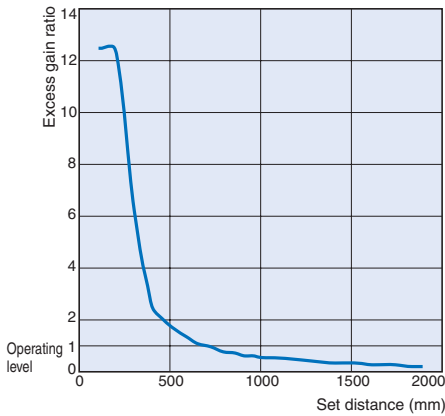

E3T-SR2□ + E39-R4 (Provided)

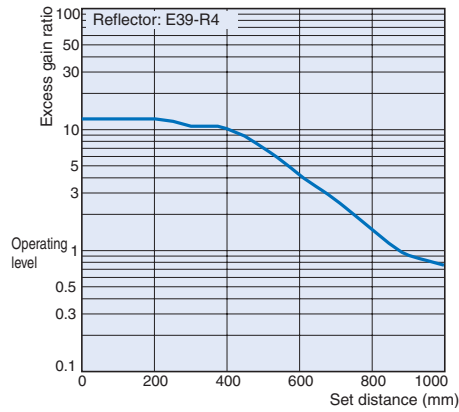

E3T-SR3□ + E39-R37 (Provided)

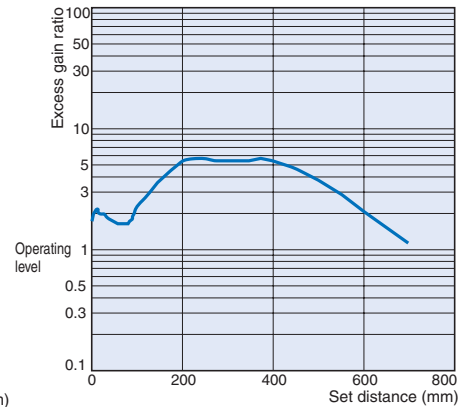

Diffuse-reflective

E3T-FD1□

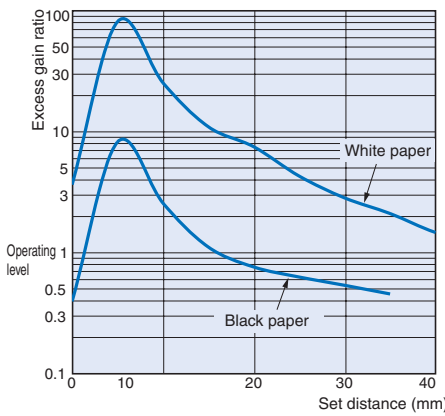

Convergent-reflective

E3T-SL1□

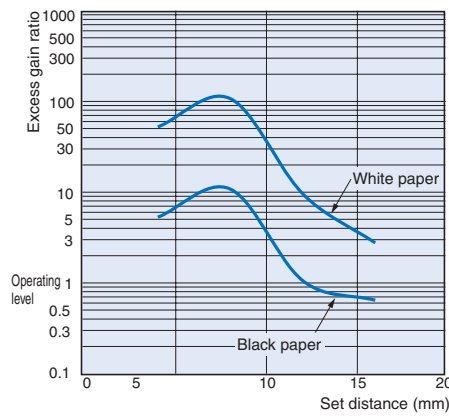

E3T-SL2□

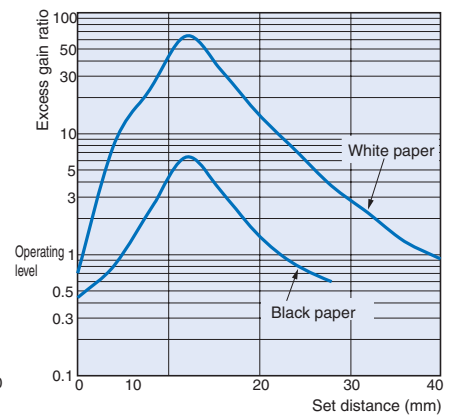

Sensing Object Size vs. Sensing Distance

E3T-SL1□

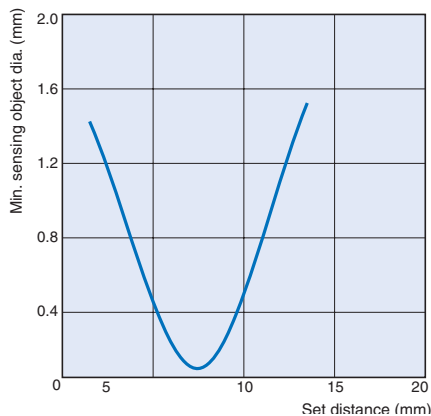

E3T-FD1□, E3T-SL2□

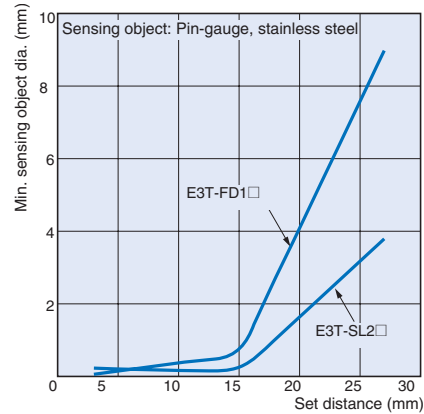

Sensing Distance vs. Material

Convergent-reflective

E3T-SL1 □

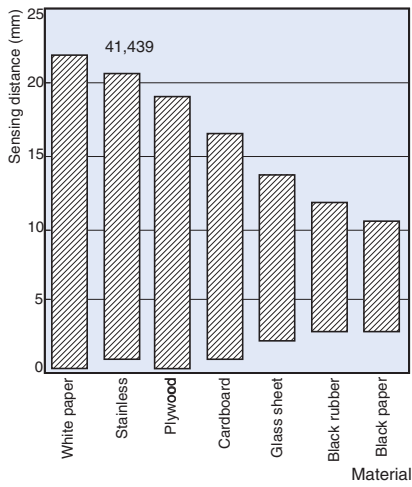

E3T-SL2 □

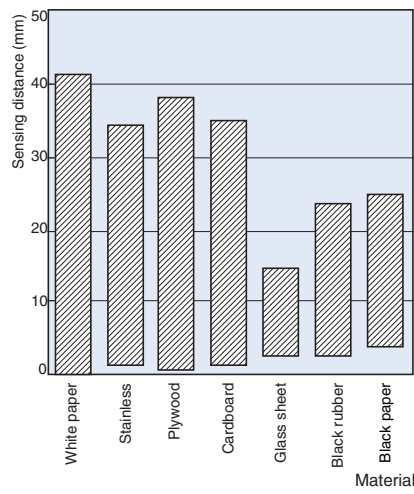

Diffuse-reflective

E3T-FD1 □

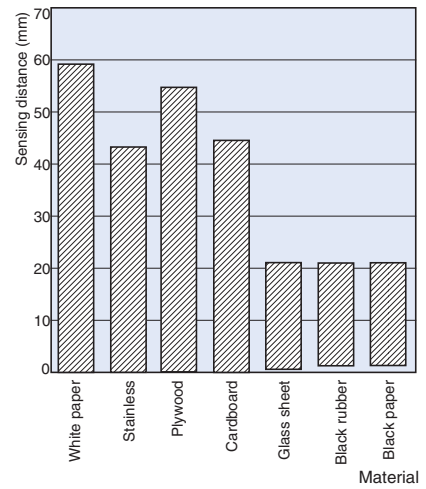

BGS Reflective

E3T-FL1 □

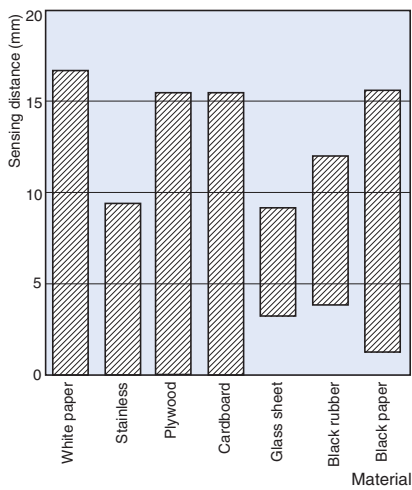

E3T-FL2 □

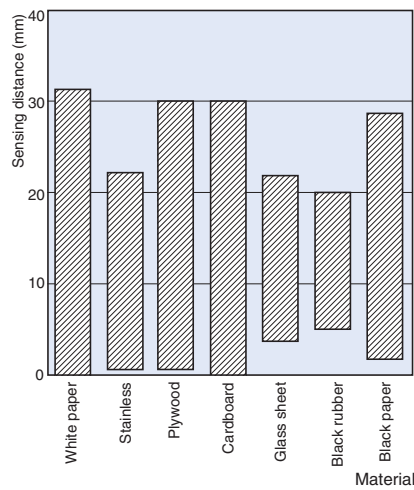

Sensing Distance Characteristics of Sensitivity Adjustment Unit (when Completing Optical Axial Adjustment)

E3T-ST1 □ + E39-E10 Sensitivity Adjustment Unit (Order Separately)

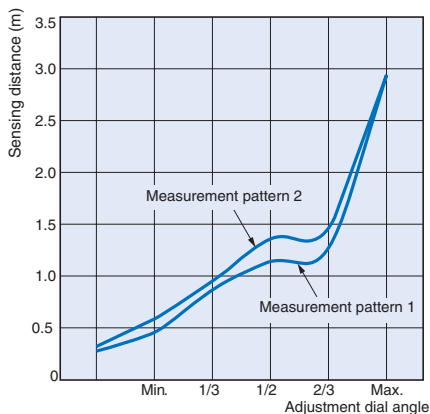

I/O Circuit Diagrams

NPN Output

Model	Operation mode	Timing charts	Output circuit
E3T-□□□1	Light-ON	<p>Light incident Light interrupted</p> <p>Operation indicator (orange) ON OFF</p> <p>Output transistor ON OFF</p> <p>Load (e.g., relay) Operate Reset</p> <p>(Between brown and black)</p>	<p>Through-beam Receivers, Retroreflective and Reflective Models</p> <p>e-CON Connector Pin Arrangement</p> <p>Note: Pin 2 is not used. Pins 2 and 4 are not used with Through-beam Emitters.</p>
E3T-□□□2	Dark-ON	<p>Light incident Light interrupted</p> <p>Operation indicator (orange) ON OFF</p> <p>Output transistor ON OFF</p> <p>Load (e.g., relay) Operate Reset</p> <p>(Between brown and black)</p>	<p>Through-beam Emitters</p> <p>e-CON Connector Pin Arrangement</p> <p>Note: Pin 2 is not used. Pins 2 and 4 are not used with Through-beam Emitters.</p>

PNP Output

Model	Operation mode	Timing charts	Output circuit
E3T-□□□3	Light-ON	<p>Light incident Light interrupted</p> <p>Operation indicator (orange) ON OFF</p> <p>Output transistor ON OFF</p> <p>Load (e.g., relay) Operate Reset</p> <p>(Between blue and black leads)</p>	<p>Through-beam Receivers, Retroreflective and Reflective Models</p> <p>e-CON Connector Pin Arrangement</p> <p>Note: Pin 2 is not used. Pins 2 and 4 are not used with Through-beam Emitters.</p>
E3T-□□□4	Dark-ON	<p>Light incident Light interrupted</p> <p>Operation indicator (orange) ON OFF</p> <p>Output transistor ON OFF</p> <p>Load (e.g., relay) Operate Reset</p> <p>(Between blue and black leads)</p>	<p>Through-beam Emitters</p> <p>e-CON Connector Pin Arrangement</p> <p>Note: Pin 2 is not used. Pins 2 and 4 are not used with Through-beam Emitters.</p>

Connectors

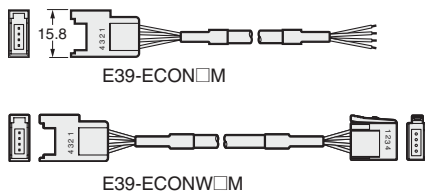

Classification	Wire color	Connector pin No.	Application
DC	Brown	1	Power supply (+V)
	White	2	---
	Brown	3	Power supply (0 V)
	White	4	Output

Note: Pin 2 is not used.

Safety Precautions

Warning

This product is not designed or rated for ensuring safety of persons. Do not use it for such purpose.



Do not apply AC power to the E3T, otherwise the E3T may rupture.



Precautions for Correct Use

Do not use the product in atmospheres or environment that exceed product ratings.

Wiring

The maximum power supply voltage is 24 VDC +10%. Before turning the power ON, make sure that the power supply voltage is not more than maximum voltage.

Load short-circuit protection

The E3T incorporates a load short-circuit protection function. If the load short-circuits, the output of the E3T will be turned OFF. Then, recheck the wiring and turn on the E3T again to reset the load short-circuit protection function. The load short-circuit protection function will work if there is a current flow that is 2.4 times larger than the rated load current. When using an inductance load, be sure that the inrush current will not exceed 2.4 times larger than the rated current.

Mounting

When mounting the Sensor, never strike it with a heavy object, such as a hammer. Doing so may reduce its watertight properties. Use M2 screws and flat or spring washers to secure the Sensor. (Tightening torque: 0.15 N·m max.)

Mounting the Sensor on Moving Parts

Consider models that use break resistant cables (e.g., Robotics Cables) if the Sensor will be mounted on a moving part, such as a robot hand. The flexing resistance of Robotics Cable at approximately 400 thousand times is far superior to that of standard cable at approximately 14 thousand times.

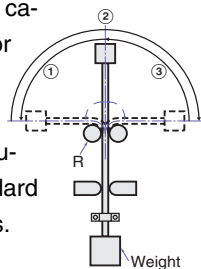

Cable Bending Rupture Test (Tough Cable Breaking Test)

The cable is repeatedly bent with power supplied to check the number of bends until the current is turned OFF

Specimen		Standard cable 2.4 mm dia. (7/ 0.127 mm dia.), 3 conductors	Robotics cable 2.4 mm (20/ 0.08 mm dia.), Test 3 conductors
Test	Bending angle (θ)	90° each to the left and right	
	Bending speed	50 times/min	
	Load	200 g	
	Operation per bend	Once in 1 to 3 in the diagram	
	Curvature radius of support point (R)	5 mm	
Result		Approx. 14,000 times	Approx. 400,000 times

Adjusting Indicators

- The following graphs indicate the status of each operating level.
- Be sure to use the E3T within the stable operating range.

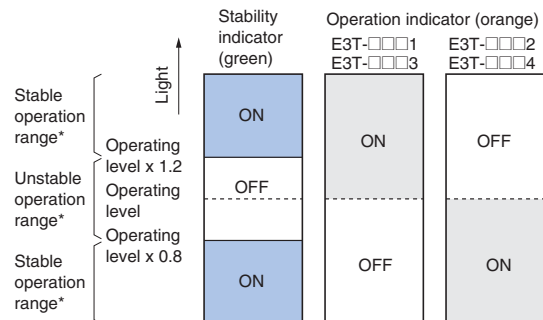

*If the E3T's operating level is set to the stable operation range, the E3T will be in most reliable operation without being influenced by temperature change, voltage fluctuation, dust, or setting change. If the operating level cannot be set to the stable operation range, pay attention to environmental changes while operating the E3T.

Use of E39-E10 Sensitivity Adjustment Unit (Dark-ON: E3T-ST12)

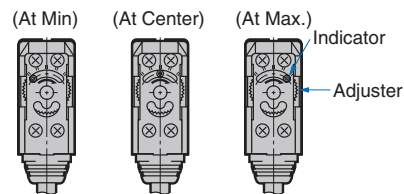

- Mount the Unit on the Receiver.
- Set the adjuster of the Sensitivity Adjustment Unit to Max. (Before shipping: Max.)
- After mounting on the Sensor, adjust the optical axis and secure the Sensor.
- Place a workpiece between the Emitter and Receiver and gradually turn the adjuster counterclockwise toward the Min. side. Stop turning the adjuster when the operation indicator and stability indicator (green) turn ON.
- Remove the workpiece and confirm that the operation indicator is OFF and the stability indicator (green) is ON. This completes the adjustment.

Note: If the light attenuation rate due to a workpiece is 40% or less, the stability indicator will not turn ON whether or not light is received. When the variation of light is small such as when sensing semi-transparent workpieces, carefully perform preliminary testing.

Others

Do not install the E3T in the following locations.

- Locations subject to excessive dust or dirt
- Locations subject to direct sunlight
- Locations subject to corrosive gas
- Locations subject to contact with organic solvents
- Locations subject to vibration and shock
- Locations subject to contact with water, oil, or chemicals
- Locations subject to high humidities that might result in condensation

Dimensions

Sensors

Through-beam Models (Side-view)

E3T-ST1□ (Emitter)
E3T-ST2□ (Emitter)

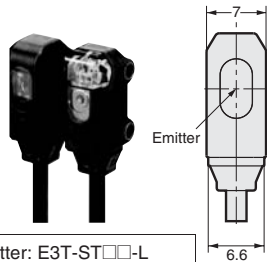

Emitter: E3T-ST□□-L
Receiver: E3T-ST□□-D

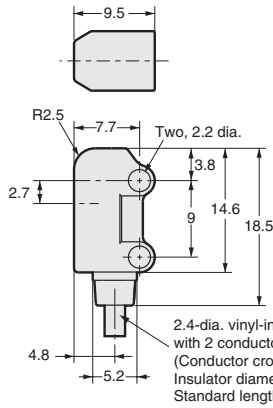

Mounting Holes

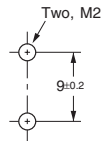

* Refer to *Mounting the Sensor on Moving Parts* on page 16 for details on Robotics Cable models.

e-CON Pre-wired Connector Model (E3T-ST□□-ECON)

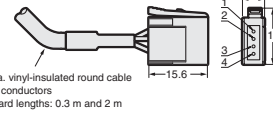

Terminal No.	Specifications
1	+V
2	---
3	0 V
4	---

E3T-ST1□ (Receiver)
E3T-ST2□ (Receiver)

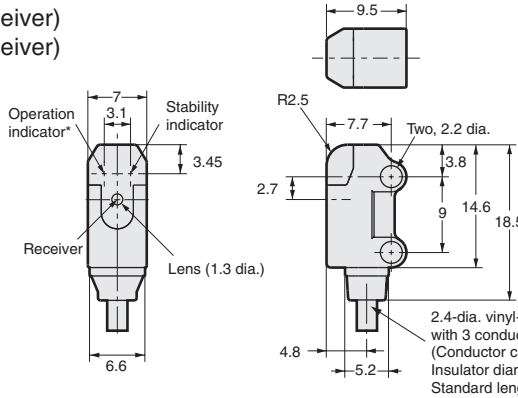

Mounting Holes

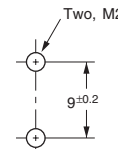

* Refer to *Mounting the Sensor on Moving Parts* on page 16 for details on Robotics Cable models.

e-CON Pre-wired Connector Model (E3T-ST□□-ECON)

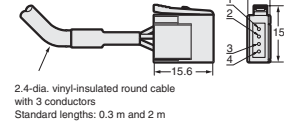

Terminal No.	Specifications
1	+V
2	---
3	0 V
4	Output

Through-beam Models (Flat)

E3T-FT1□ (Emitter)
E3T-FT2□ (Emitter)



Emitter: E3T-FT□□-L
Receiver: E3T-FT□□-D

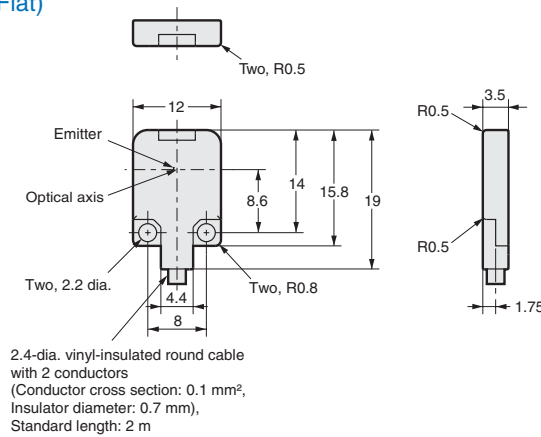

Mounting Holes

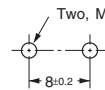

* Refer to *Mounting the Sensor on Moving Parts* on page 16 for details on Robotics Cable models.

e-CON Pre-wired Connector (E3T-FT□□-ECON)

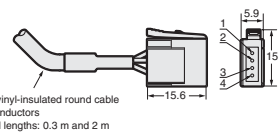

Terminal No.	Specifications
1	+V
2	---
3	0 V
4	---

E3T-FT1□ (Receiver)
E3T-FT2□ (Receiver)

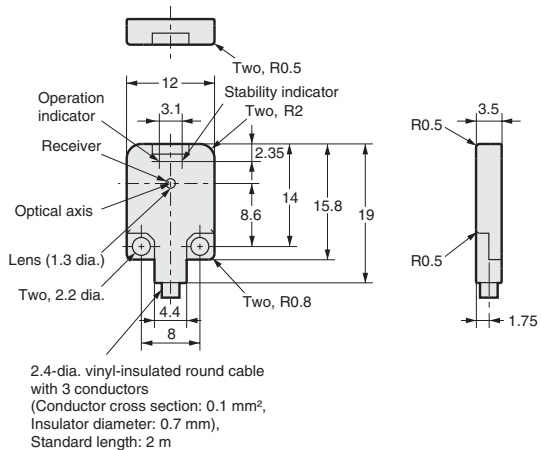

Mounting Holes

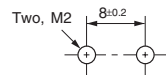

* Refer to *Mounting the Sensor on Moving Parts* on page 16 for details on Robotics Cable models.

e-CON Pre-wired Connector (E3T-FT□□-ECON)

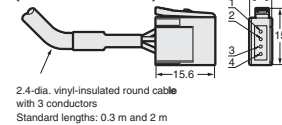

Terminal No.	Specifications
1	+V
2	---
3	0 V
4	Output

Retro-reflective Models (Side-view)

E3T-SR2□
E3T-SR3□

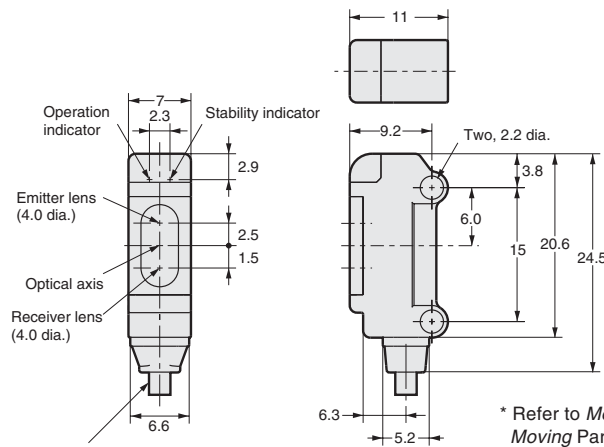

2.4-dia. vinyl-insulated round cable with 3 conductors (Conductor cross section: 0.1 mm², Insulator diameter: 0.7 mm), Standard length: 2 m

Mounting Holes

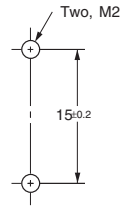

e-CON Pre-wired Connector (E3T-SR□□-ECON)

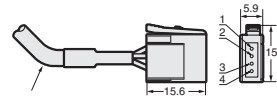

2.4-dia. vinyl-insulated round cable with 3 conductors Standard lengths: 0.3 m and 2 m

Terminal No.	Specifications
1	+V
2	---
3	0 V
4	Output

* Refer to *Mounting the Sensor on Moving Parts* on page 16 for details on Robotics Cable models.

Diffuse-reflective Models (Flat)

E3T-FD1□

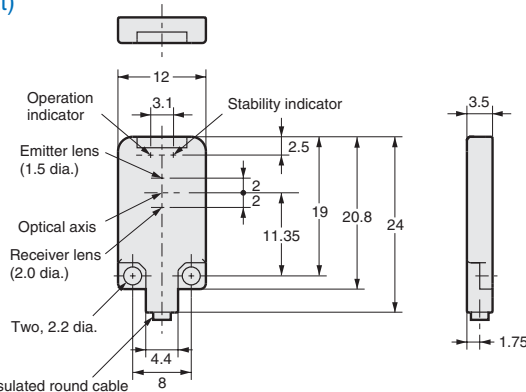

2.4-dia. vinyl-insulated round cable with 3 conductors (Conductor cross section: 0.1 mm², Insulator diameter: 0.7 mm), Standard length: 2 m

Mounting Holes



e-CON Pre-wired Connector (E3T-FD□□-ECON)

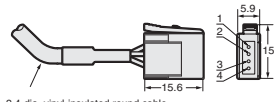

2.4-dia. vinyl-insulated round cable with 3 conductors Standard lengths: 0.3 m and 2 m

Terminal No.	Specifications
1	+V
2	---
3	0 V
4	Output

* Refer to *Mounting the Sensor on Moving Parts* on page 16 for details on Robotics Cable models.

Convergent-reflective Models (Side-view)

E3T-SL1□
E3T-SL2□

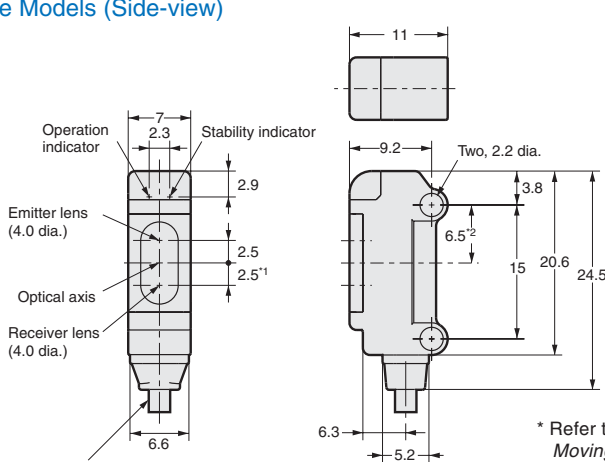

2.4-dia. vinyl-insulated round cable with 3 conductors (Conductor cross section: 0.1 mm², Insulator diameter: 0.7 mm), Standard length: 2 m

Mounting Holes

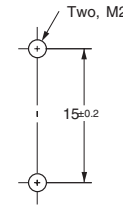

e-CON Pre-wired Connector (E3T-SL□□-ECON)

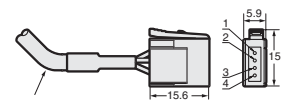

2.4-dia. vinyl-insulated round cable with 3 conductors Standard lengths: 0.3 m and 2 m

Terminal No.	Specifications
1	+V
2	---
3	0 V
4	Output

* Refer to *Mounting the Sensor on Moving Parts* on page 16 for details on Robotics Cable models.

BGS Models (Flat)

- E3T-FL1□
- E3T-FL2□

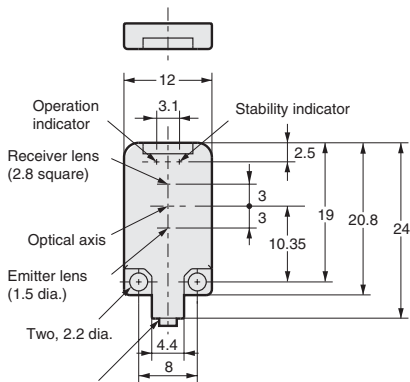

Mounting Holes

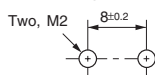

e-CON Pre-wired Connector (E3T-FL□□-ECON)

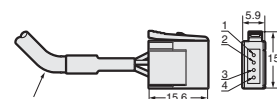

2.4-dia. vinyl-insulated round cable with 3 conductors
Standard lengths: 0.3 m and 2 m

2.4-dia. vinyl-insulated round cable with 3 conductors
(Conductor cross section: 0.1 mm², Insulator diameter: 0.7 mm), Standard length: 2 m

* Refer to *Mounting the Sensor on Moving Parts* on page 16 for details on Robotics Cable models.

Terminal No.	Specifications
1	+V
2	---
3	0 V
4	Output

Accessories

Reflector (Provided with E3T-SR2□)

E39-R4



Material, reflective surface: acrylic
Rear surface: ABS

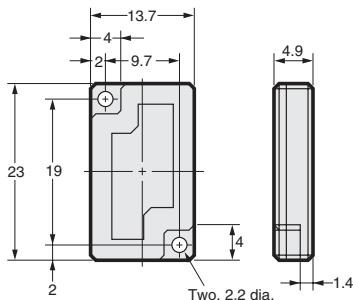

Reflector (Provided with E3T-SR3□)

E39-R37



Material: Mounting plate: stainless steel (SUS301)
Reflective surface: acrylic

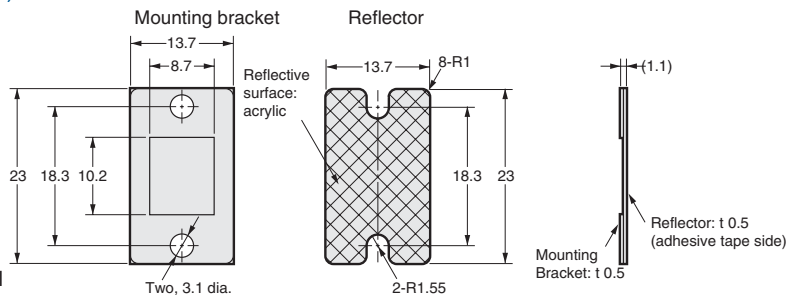

Note: The reflective plate and mounting plate (1) come as a set.

Accessories (Order Separately)

Slit for E3T-ST1□ Through-beam Models
E39-S63

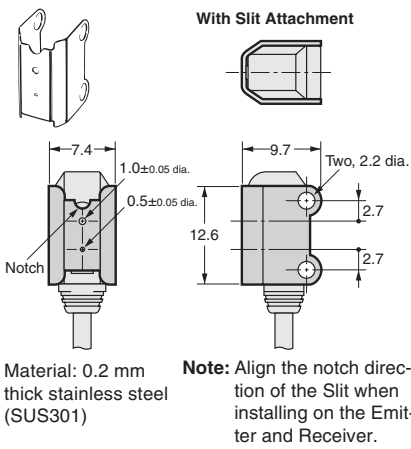

Slit for E3T-FT1□ Through-beam Models
E39-S64

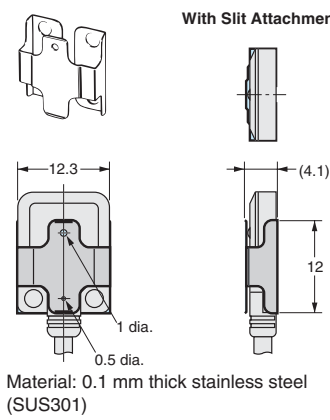

Sensitivity Adjustment Unit
(for E3T-ST1□ Through-beam Models)
E39-E10

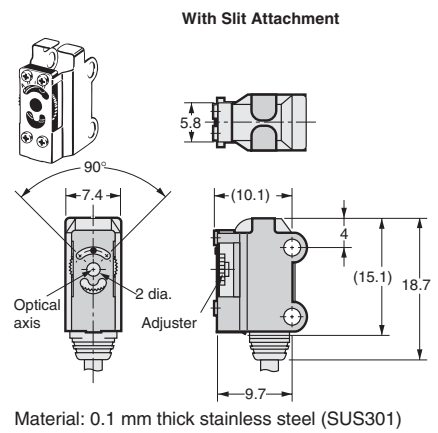

Mounting Brackets for Side-view Models

E39-L116

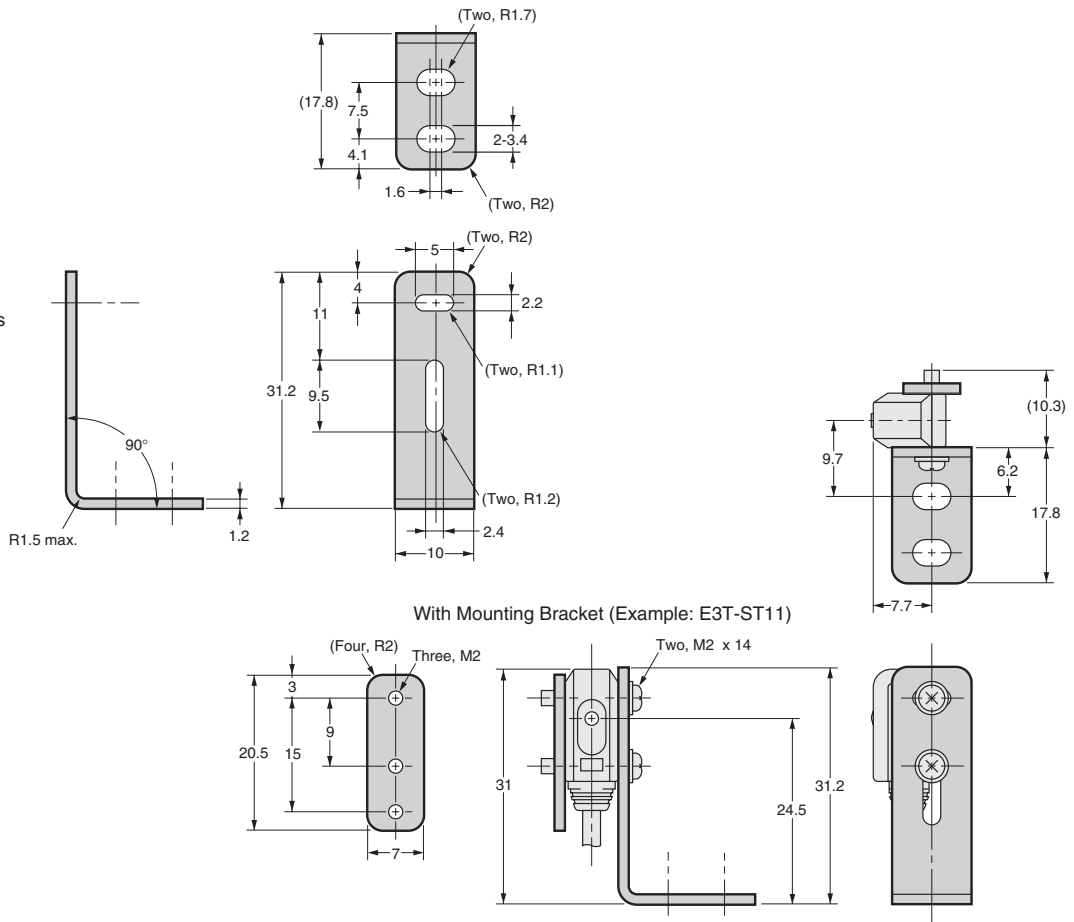

Mounting Brackets for Side-view Models

E39-L117



Material: 1.2 mm thick stainless steel (SUS304)

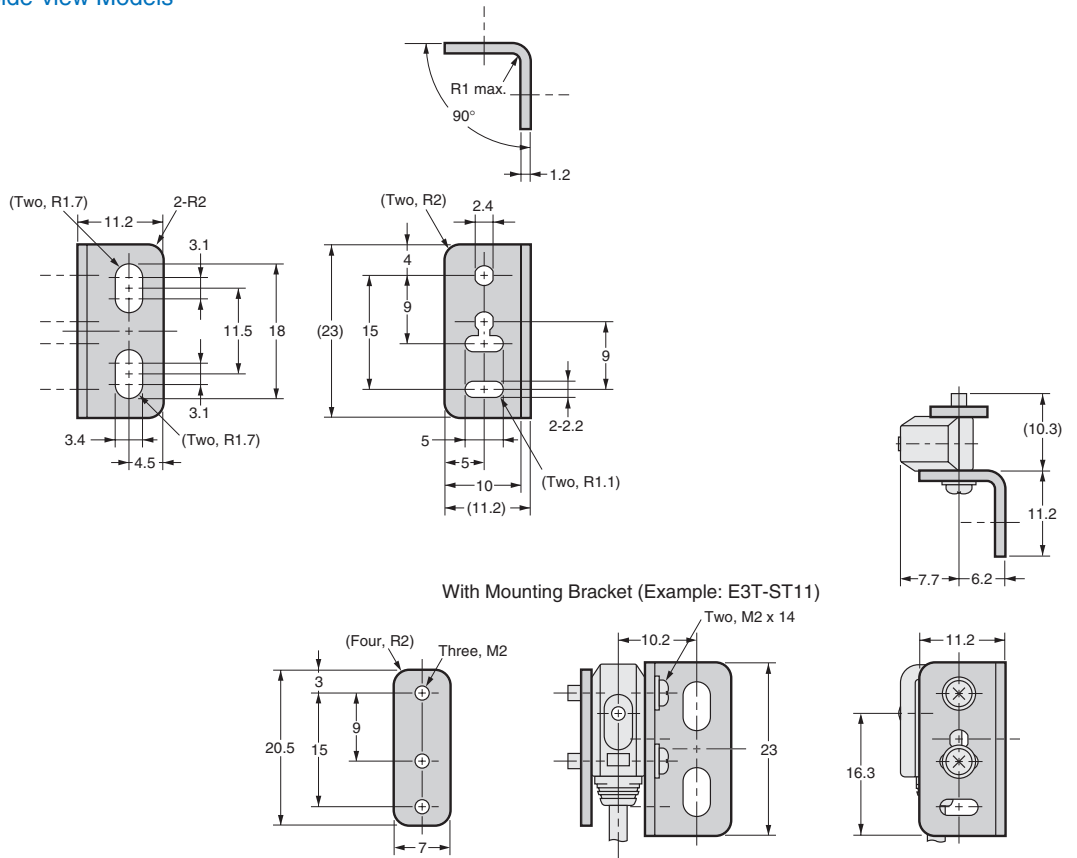

Mounting Brackets for Side-view Models

E39-L118



Material: 1.2 mm thick stainless steel (SUS304)

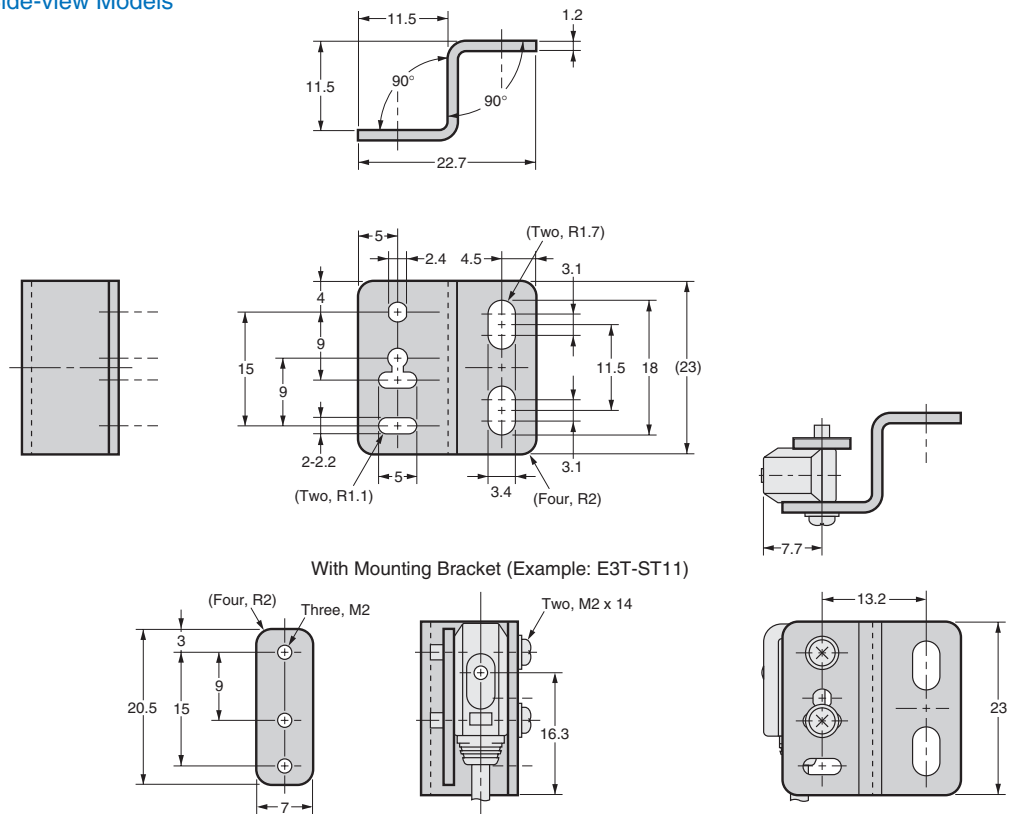

Mounting Brackets for Flat Models

E39-L119



Material: 1.2 mm thick stainless steel (SUS304)

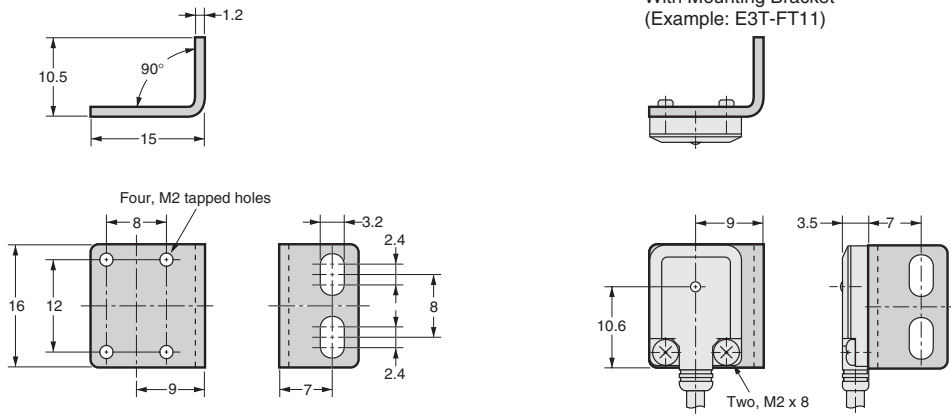

Mounting Brackets for Flat Models

E39-L120



Material: 1.2 mm thick stainless steel (SUS304)

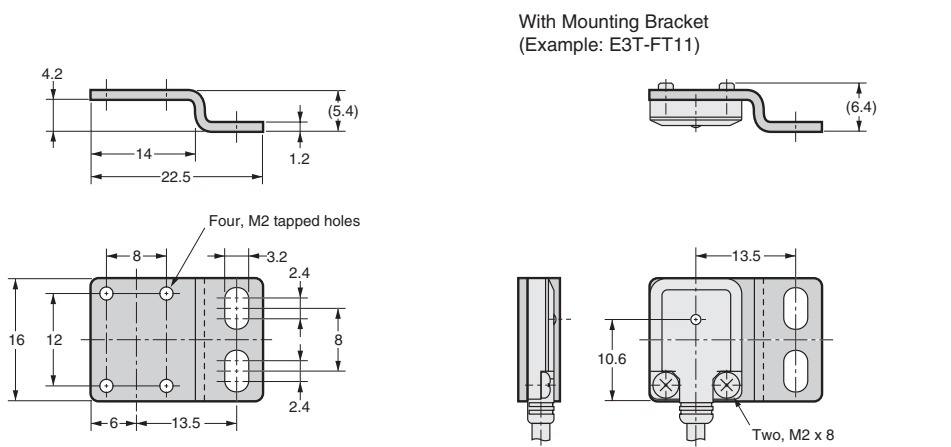

READ AND UNDERSTAND THIS DOCUMENT

Please read and understand this document before using the products. Please consult your OMRON representative if you have any questions or comments.

WARRANTY

OMRON's exclusive warranty is that the products are free from defects in materials and workmanship for a period of one year (or other period if specified) from date of sale by OMRON.

OMRON MAKES NO WARRANTY OR REPRESENTATION, EXPRESS OR IMPLIED, REGARDING NON-INFRINGEMENT, MERCHANTABILITY, OR FITNESS FOR PARTICULAR PURPOSE OF THE PRODUCTS. ANY BUYER OR USER ACKNOWLEDGES THAT THE BUYER OR USER ALONE HAS DETERMINED THAT THE PRODUCTS WILL SUITABLY MEET THE REQUIREMENTS OF THEIR INTENDED USE. OMRON DISCLAIMS ALL OTHER WARRANTIES, EXPRESS OR IMPLIED.

LIMITATIONS OF LIABILITY

OMRON SHALL NOT BE RESPONSIBLE FOR SPECIAL, INDIRECT, OR CONSEQUENTIAL DAMAGES, LOSS OF PROFITS OR COMMERCIAL LOSS IN ANY WAY CONNECTED WITH THE PRODUCTS, WHETHER SUCH CLAIM IS BASED ON CONTRACT, WARRANTY, NEGLIGENCE, OR STRICT LIABILITY.

In no event shall responsibility of OMRON for any act exceed the individual price of the product on which liability is asserted.

IN NO EVENT SHALL OMRON BE RESPONSIBLE FOR WARRANTY, REPAIR, OR OTHER CLAIMS REGARDING THE PRODUCTS UNLESS OMRON'S ANALYSIS CONFIRMS THAT THE PRODUCTS WERE PROPERLY HANDLED, STORED, INSTALLED, AND MAINTAINED AND NOT SUBJECT TO CONTAMINATION, ABUSE, MISUSE, OR INAPPROPRIATE MODIFICATION OR REPAIR.

SUITABILITY FOR USE

THE PRODUCTS CONTAINED IN THIS DOCUMENT ARE NOT SAFETY RATED. THEY ARE NOT DESIGNED OR RATED FOR ENSURING SAFETY OF PERSONS, AND SHOULD NOT BE RELIED UPON AS A SAFETY COMPONENT OR PROTECTIVE DEVICE FOR SUCH PURPOSES. Please refer to separate catalogs for OMRON's safety rated products.

OMRON shall not be responsible for conformity with any standards, codes, or regulations that apply to the combination of products in the customer's application or use of the product.

At the customer's request, OMRON will provide applicable third party certification documents identifying ratings and limitations of use that apply to the products. This information by itself is not sufficient for a complete determination of the suitability of the products in combination with the end product, machine, system, or other application or use.

The following are some examples of applications for which particular attention must be given. This is not intended to be an exhaustive list of all possible uses of the products, nor is it intended to imply that the uses listed may be suitable for the products:

- Outdoor use, uses involving potential chemical contamination or electrical interference, or conditions or uses not described in this document.
- Nuclear energy control systems, combustion systems, railroad systems, aviation systems, medical equipment, amusement machines, vehicles, safety equipment, and installations subject to separate industry or government regulations.
- Systems, machines, and equipment that could present a risk to life or property.

Please know and observe all prohibitions of use applicable to the products.

NEVER USE THE PRODUCTS FOR AN APPLICATION INVOLVING SERIOUS RISK TO LIFE OR PROPERTY WITHOUT ENSURING THAT THE SYSTEM AS A WHOLE HAS BEEN DESIGNED TO ADDRESS THE RISKS, AND THAT THE OMRON PRODUCT IS PROPERLY RATED AND INSTALLED FOR THE INTENDED USE WITHIN THE OVERALL EQUIPMENT OR SYSTEM.

PERFORMANCE DATA

Performance data given in this document is provided as a guide for the user in determining suitability and does not constitute a warranty. It may represent the result of OMRON's test conditions, and the users must correlate it to actual application requirements. Actual performance is subject to the OMRON Warranty and Limitations of Liability.

CHANGE IN SPECIFICATIONS

Product specifications and accessories may be changed at any time based on improvements and other reasons.

It is our practice to change model numbers when published ratings or features are changed, or when significant construction changes are made. However, some specifications of the product may be changed without any notice. When in doubt, special model numbers may be assigned to fix or establish key specifications for your application on your request. Please consult with your OMRON representative at any time to confirm actual specifications of purchased products.

DIMENSIONS AND WEIGHTS

Dimensions and weights are nominal and are not to be used for manufacturing purposes, even when tolerances are shown.

ERRORS AND OMISSIONS

The information in this document has been carefully checked and is believed to be accurate; however, no responsibility is assumed for clerical, typographical, or proofreading errors, or omissions.

PROGRAMMABLE PRODUCTS

OMRON shall not be responsible for the user's programming of a programmable product, or any consequence thereof.

COPYRIGHT AND COPY PERMISSION

This document shall not be copied for sales or promotions without permission.

This document is protected by copyright and is intended solely for use in conjunction with the product. Please notify us before copying or reproducing this document in any manner, for any other purpose. If copying or transmitting this document to another, please copy or transmit it in its entirety.

Cat. No. E377-E1-01-X

In the interest of product improvement, specifications are subject to change without notice.

OMRON EUROPE B.V.

Wegalaan 67-69,
NL-2132 JD, Hoofddorp,
The Netherlands
Phone: +31 23 568 13 00
Fax: +31 23 568 13 88
www.eu.omron.com