

150-mA LOW-NOISE LOW-DROPOUT REGULATOR WITH SHUTDOWN

Check for Samples: [LP2985](#)

FEATURES

- Output Tolerance of
 - 1% (A Grade)
 - 1.5% (Standard Grade)
- Ultra-Low Dropout, Typically
 - 280 mV at Full Load of 150 mA
 - 7 mV at 1 mA
- Wide V_{IN} Range: 16 V Max
- Low I_Q : 850 μ A at Full Load at 150 mA
- Shutdown Current: 0.01 μ A Typ
- Low Noise: 30 μ V_{RMS} With 10-nF Bypass Capacitor
- Stable With Low-ESR Capacitors, Including Ceramic
- Overcurrent and Thermal Protection
- High Peak-Current Capability
- ESD Protection Exceeds JESD 22

- 2000-V Human-Body Model (A114-A)
- 200-V Machine Model (A115-A)

PORTABLE APPLICATIONS

- Cellular Phones
- Palmtop and Laptop Computers
- Personal Digital Assistants (PDAs)
- Digital Cameras and Camcorders
- CD Players
- MP3 Players

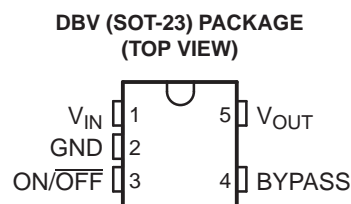

DESCRIPTION/ORDERING INFORMATION

The LP2985 family of fixed-output, low-dropout regulators offers exceptional, cost-effective performance for both portable and nonportable applications. Available in voltages of 1.8 V, 2.5 V, 2.8 V, 2.9 V, 3 V, 3.1 V, 3.3 V, 5 V, and 10 V, the family has an output tolerance of 1% for the A version (1.5% for the non-A version) and is capable of delivering 150-mA continuous load current. Standard regulator features, such as overcurrent and overtemperature protection, are included.

The LP2985 has a host of features that makes the regulator an ideal candidate for a variety of portable applications:

- Low dropout: A PNP pass element allows a typical dropout of 280 mV at 150-mA load current and 7 mV at 1-mA load.
- Low quiescent current: The use of a vertical PNP process allows for quiescent currents that are considerably lower than those associated with traditional lateral PNP regulators.
- Shutdown: A shutdown feature is available, allowing the regulator to consume only 0.01 μ A when the ON/OFF pin is pulled low.
- Low-ESR-capacitor friendly: The regulator is stable with low-ESR capacitors, allowing the use of small, inexpensive, ceramic capacitors in cost-sensitive applications.
- Low noise: A BYPASS pin allows for low-noise operation, with a typical output noise of 30 μ V_{RMS}, with the use of a 10-nF bypass capacitor.
- Small packaging: For the most space-constrained needs, the regulator is available in the SOT-23 package.



Please be aware that an important notice concerning availability, standard warranty, and use in critical applications of Texas Instruments semiconductor products and disclaimers thereto appears at the end of this data sheet.

ORDERING INFORMATION⁽¹⁾

T _J	PART GRADE	V _{OUT} (NOM)	PACKAGE ⁽²⁾	ORDERABLE PART NUMBER	TOP-SIDE MARKING ⁽³⁾	
-40°C to 125°C	A grade: 1% tolerance	1.8 V	SOT-23-5 – DBV	Reel of 3000	LP2985A-18DBVR	LPT_
				Reel of 250	LP2985A-18DBVT	
				Reel of 10000	LP2985A-18DBVJ	
		2.5 V		Reel of 3000	LP2985A-25DBVR	LPU_
				Reel of 250	LP2985A-25DBVT	
		2.8 V		Reel of 3000	LP2985A-28DBVR	LPJ_
				Reel of 250	LP2985A-28DBVT	
		2.9 V		Reel of 3000	LP2985A-29DBVR	LPZ_
				Reel of 250	LP2985A-29DBVT	
		3.0 V		Reel of 3000	LP2985A-30DBVR	LRA_
				Reel of 250	LP2985A-30DBVT	
		3.1 V		Reel of 3000	LP2985A-31DBVR	PREVIEW
				Reel of 250	LP2985A-31DBVT	
		3.3 V		Reel of 3000	LP2985A-33DBVR	LPK_
				Reel of 250	LP2985A-33DBVT	
		5.0 V		Reel of 3000	LP2985A-50DBVR	LRI_
				Reel of 250	LP2985A-50DBVT	
		10.0 V		Reel of 3000	LP2985A-10DBVR	LRD_
	Reel of 250		LP2985A-10DBVT			
	Standard grade: 1.5% tolerance	1.8 V	Reel of 3000	LP2985-18DBVR	LPH_	
			Reel of 250	LP2985-18DBVT		
		2.5 V	Reel of 3000	LP2985-25DBVR	LPL_	
			Reel of 250	LP2985-25DBVT		
		2.8 V	Reel of 3000	LP2985-28DBVR	LPG_	
			Reel of 250	LP2985-28DBVT		
		2.9 V	Reel of 3000	LP2985-29DBVR	LPM_	
			Reel of 250	LP2985-29DBVT		
		3.0 V	Reel of 3000	LP2985-30DBVR	LPN_	
			Reel of 250	LP2985-30DBVT		
		3.1 V	Reel of 3000	LP2985-31DBVR	PREVIEW	
			Reel of 250	LP2985-31DBVT		
		3.3 V	Reel of 3000	LP2985-33DBVR	LPF_	
			Reel of 250	LP2985-33DBVT		
		5.0 V	Reel of 3000	LP2985-50DBVR	LPS_	
			Reel of 250	LP2985-50DBVT		
		10.0 V	Reel of 3000	LP2985-10DBVR	LRC_	
Reel of 250			LP2985-10DBVT			

- (1) For the most current package and ordering information, see the Package Option Addendum at the end of this document, or see the TI web site at www.ti.com.
- (2) Package drawings, thermal data, and symbolization are available at www.ti.com/packaging.
- (3) The actual top-side marking has one additional character that designates the wafer fab/assembly site.

FUNCTIONAL BLOCK DIAGRAM

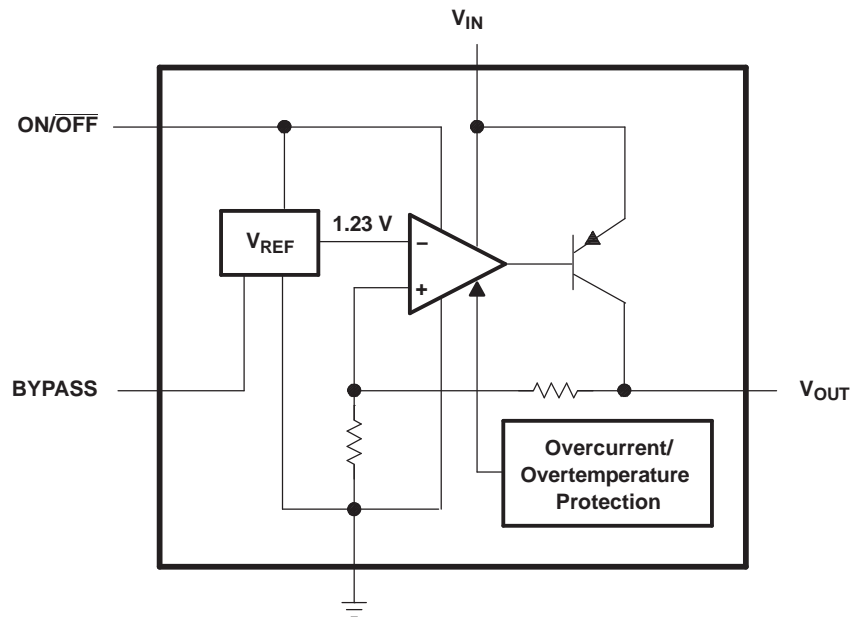
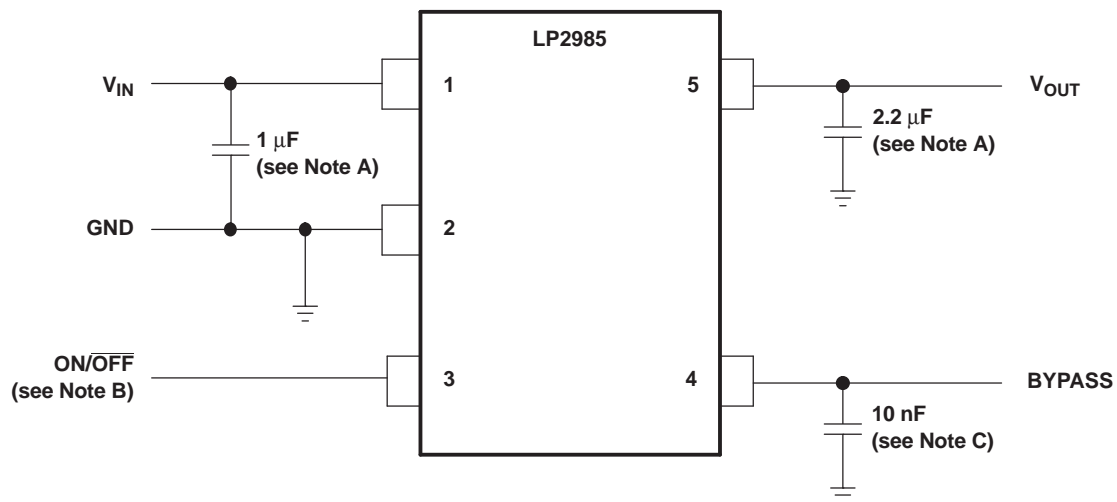

Figure 1. BASIC APPLICATION CIRCUIT



- A. Minimum C_{OUT} value for stability (can be increased without limit for improved stability and transient response)
- B. ON/\overline{OFF} must be actively terminated. Connect to V_{IN} if shutdown feature is not used.
- C. Optional BYPASS capacitor for low-noise operation

Absolute Maximum Ratings⁽¹⁾

over virtual junction temperature range (unless otherwise noted)

		MIN	MAX	UNIT
V_{IN}	Continuous input voltage range ⁽²⁾	-0.3	16	V
$V_{ON/OFF}$	ON/OFF input voltage range	-0.3	16	V
	Output voltage range ⁽³⁾	-0.3	9	V
I_O	Output current ⁽⁴⁾	Internally limited (short-circuit protected)		
θ_{JA}	Package thermal impedance ^{(4) (5)}		206	°C/W
T_J	Operating virtual junction temperature		150	°C
T_{stg}	Storage temperature range	-65	150	°C
ESD	Electrostatic discharge protection	Human-Body Model (HBM)	2000	V
		Machine Model (MM)	200	

- (1) Stresses beyond those listed under "absolute maximum ratings" may cause permanent damage to the device. These are stress ratings only, and functional operation of the device at these or any other conditions beyond those indicated under "recommended operating conditions" is not implied. Exposure to absolute-maximum-rated conditions for extended periods may affect device reliability.
- (2) The PNP pass transistor has a parasitic diode connected between the input and output. This diode normally is reverse biased ($V_{IN} > V_{OUT}$), but will be forward biased if the output voltage exceeds the input voltage by a diode drop (see *Application Information* for more details).
- (3) If load is returned to a negative power supply in a dual-supply system, the output must be diode clamped to GND.
- (4) Maximum power dissipation is a function of $T_J(\max)$, θ_{JA} , and T_A . The maximum allowable power dissipation at any allowable ambient temperature is $P_D = (T_J(\max) - T_A)/\theta_{JA}$. Operating at the absolute maximum T_J of 150°C can affect reliability.
- (5) The package thermal impedance is calculated in accordance with JESD 51-7.

Recommended Operating Conditions

		MIN	MAX	UNIT
V_{IN}	Supply input voltage	2.2 ⁽¹⁾	16	V
$V_{ON/OFF}$	ON/OFF input voltage	0	V_{IN}	V
I_{OUT}	Output current		150	mA
T_J	Virtual junction temperature	-40	125	°C

- (1) Recommended minimum V_{IN} is the greater of 2.5 V or $V_{OUT(\max)} +$ rated dropout voltage (max) for operating I_L .

Electrical Characteristics

at specified virtual junction temperature range, $V_{IN} = V_{OUT(NOM)} + 1\text{ V}$, $V_{ON/OFF} = 2\text{ V}$, $C_{IN} = 1\text{ }\mu\text{F}$, $I_L = 1\text{ mA}$, $C_{OUT} = 4.7\text{ }\mu\text{F}$ (unless otherwise noted)

PARAMETER	TEST CONDITIONS	T _J	LP2985A-xx			LP2985-xx			UNIT
			MIN	TYP	MAX	MIN	TYP	MAX	
ΔV_{OUT} Output voltage tolerance	$I_L = 1\text{ mA}$	25°C	-1		1	-1.5		1.5	%V _{NOM}
	$1\text{ mA} \leq I_L \leq 50\text{ mA}$	25°C	-1.5		1.5	-2.5		2.5	
		-40°C to 125°C	-2.5		2.5	-3.5		3.5	
	$1\text{ mA} \leq I_L \leq 150\text{ mA}$	25°C	-2.5		2.5	-3		3	
-40°C to 125°C		-3.5		3.5	-4		4		
Line regulation	$V_{IN} = [V_{OUT(NOM)} + 1\text{ V}]$ to 16 V	25°C		0.007	0.014		0.007	0.014	%V
		-40°C to 125°C			0.032			0.032	
$V_{IN} - V_{OUT}$ Dropout voltage ⁽¹⁾	$I_L = 0$	25°C		1	3		1	3	mV
		-40°C to 125°C			5		5		
	$I_L = 1\text{ mA}$	25°C		7	10		7	10	
		-40°C to 125°C			15		15		
	$I_L = 10\text{ mA}$	25°C		40	60		40	60	
		-40°C to 125°C			90		90		
	$I_L = 50\text{ mA}$	25°C		120	150		120	150	
		-40°C to 125°C			225		225		
	$I_L = 150\text{ mA}$	25°C		280	350		280	350	
		-40°C to 125°C			575		575		
I_{GND} GND pin current	$I_L = 0$	25°C		65	95		65	95	μA
		25°C (LP2985-10)			125		125		
		-40°C to 125°C			125		125		
		-40°C to 125°C (LP2985-10)			160		160		
	$I_L = 1\text{ mA}$	25°C		75	110		75	110	
		25°C (LP2985-10)			140		140		
		-40°C to 125°C			170		170		
	$I_L = 10\text{ mA}$	25°C		120	220		120	220	
		25°C (LP2985-10)			250		250		
		-40°C to 125°C			400		400		
	$I_L = 50\text{ mA}$	25°C		350	600		350	600	
		25°C (LP2985-10)			650		650		
		-40°C to 125°C			1000		1000		
	$I_L = 150\text{ mA}$	25°C		850	1500		850	1500	
		25°C (LP2985-10)			1800		1800		
		-40°C to 125°C			2500		2500		
$V_{ON/OFF}$ ON/OFF input voltage ⁽²⁾	$V_{ON/OFF} = \text{HIGH} \rightarrow \text{O/P ON}$	25°C		1.4		1.4		V	
		-40°C to 125°C		1.6		1.6			
	$V_{ON/OFF} = \text{LOW} \rightarrow \text{O/P OFF}$	25°C		0.55		0.55			
		-40°C to 125°C			0.15		0.15		
$I_{ON/OFF}$ ON/OFF input current	$V_{ON/OFF} = 0$	25°C		0.01		0.01		μA	
		-40°C to 125°C			-2		-2		
	$V_{ON/OFF} = 5\text{ V}$	25°C		5		5			
		-40°C to 125°C			15		15		

(1) Dropout voltage is defined as the input-to-output differential at which the output voltage drops 100 mV below the value measured with a 1-V differential.

(2) The ON/OFF input must be driven properly for reliable operation (see *Application Information*).

Electrical Characteristics (continued)

at specified virtual junction temperature range, $V_{IN} = V_{OUT(NOM)} + 1\text{ V}$, $V_{ON/OFF} = 2\text{ V}$, $C_{IN} = 1\text{ }\mu\text{F}$, $I_L = 1\text{ mA}$, $C_{OUT} = 4.7\text{ }\mu\text{F}$ (unless otherwise noted)

PARAMETER	TEST CONDITIONS	T_J	LP2985A-xx			LP2985-xx			UNIT
			MIN	TYP	MAX	MIN	TYP	MAX	
V_n Output noise (RMS)	BW = 300 Hz to 50 kHz, $C_{OUT} = 10\text{ }\mu\text{F}$, $C_{BYPASS} = 10\text{ nF}$	25°C		30		30		μV	
$\frac{\Delta V_{OUT}}{\Delta V_{IN}}$ Ripple rejection	$f = 1\text{ kHz}$, $C_{OUT} = 10\text{ }\mu\text{F}$, $C_{BYPASS} = 10\text{ nF}$	25°C		45		45		dB	
$I_{OUT(PK)}$ Peak output current	$V_{OUT} \geq V_{O(NOM)} - 5\%$	25°C		350		350		mA	
$I_{OUT(SC)}$ Short-circuit current	$R_L = 0$ (steady state) ⁽³⁾	25°C		400		400		mA	

(3) See [Figure 7](#) in *Typical Performance Characteristics*.

TYPICAL PERFORMANCE CHARACTERISTICS

$C_{IN} = 1 \mu F$, $C_{OUT} = 4.7 \mu F$, $V_{IN} = V_{OUT(NOM)} + 1 V$, $T_A = 25^\circ C$, ON/OFF pin tied to V_{IN} (unless otherwise specified)

**OUTPUT VOLTAGE
vs
TEMPERATURE**

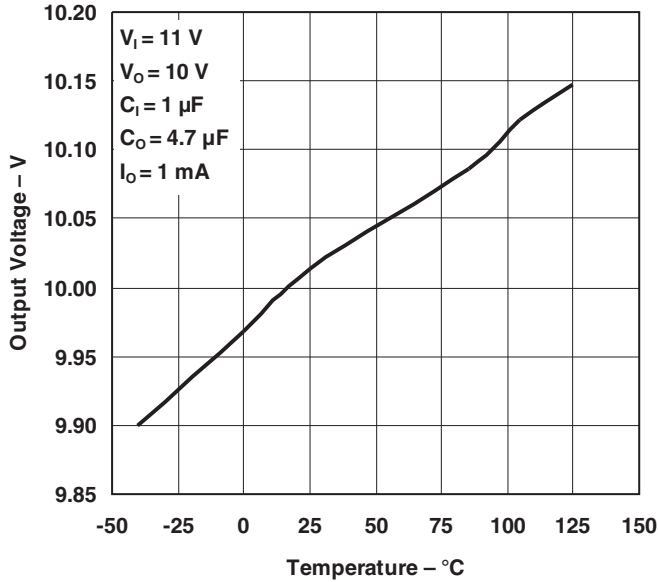

Figure 2.

**OUTPUT VOLTAGE
vs
TEMPERATURE**

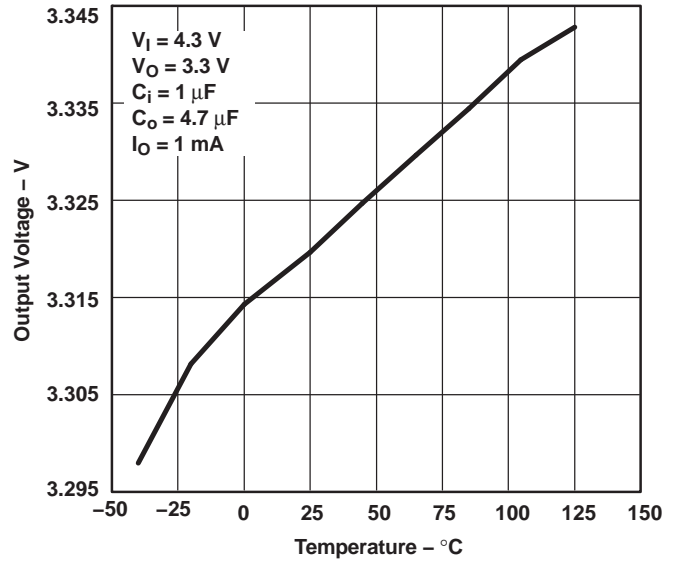

Figure 3.

**DROPOUT VOLTAGE
vs
TEMPERATURE**

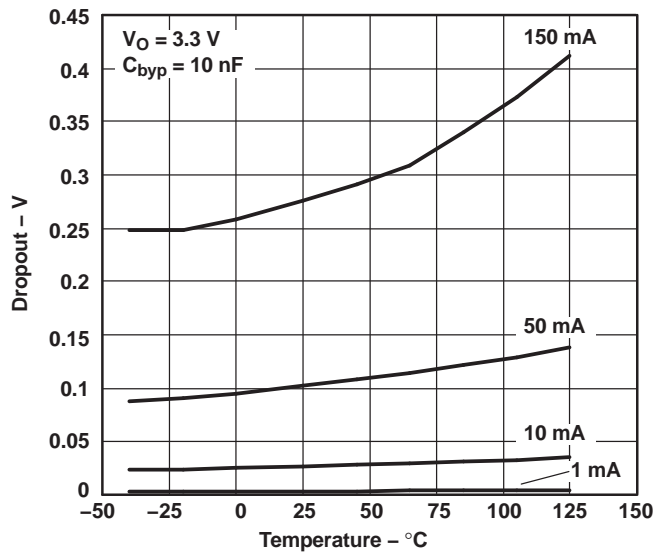

Figure 4.

**SHORT-CIRCUIT CURRENT
vs
TIME**

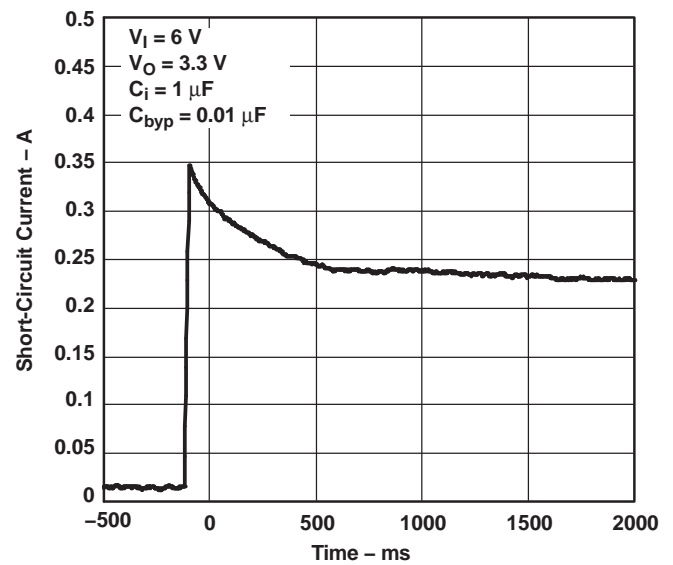

Figure 5.

TYPICAL PERFORMANCE CHARACTERISTICS (continued)

$C_{IN} = 1 \mu F$, $C_{OUT} = 4.7 \mu F$, $V_{IN} = V_{OUT(NOM)} + 1 V$, $T_A = 25^\circ C$, ON/OFF pin tied to V_{IN} (unless otherwise specified)

SHORT-CIRCUIT CURRENT

vs
TIME

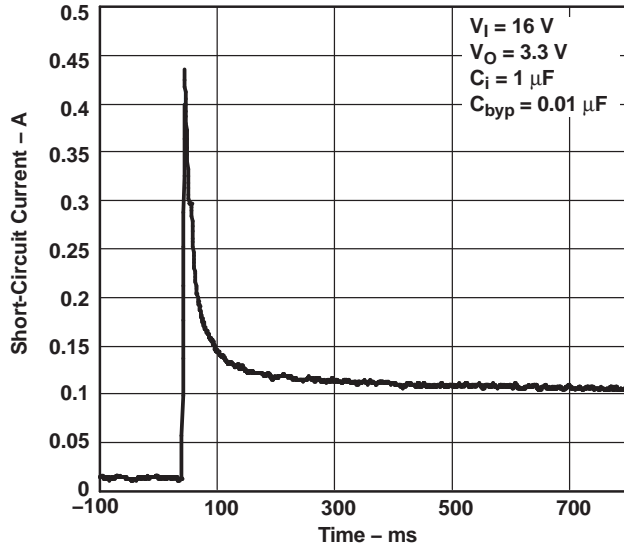

Figure 6.

SHORT-CIRCUIT CURRENT

vs
OUTPUT VOLTAGE

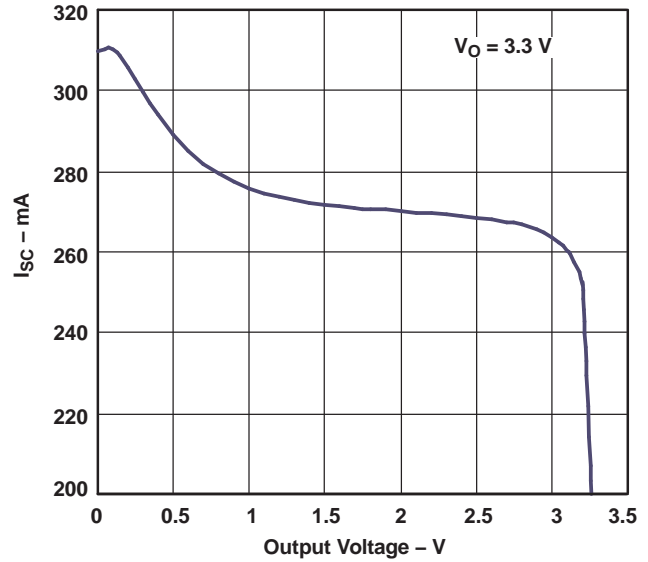

Figure 7.

GROUND-PIN CURRENT

vs
LOAD CURRENT

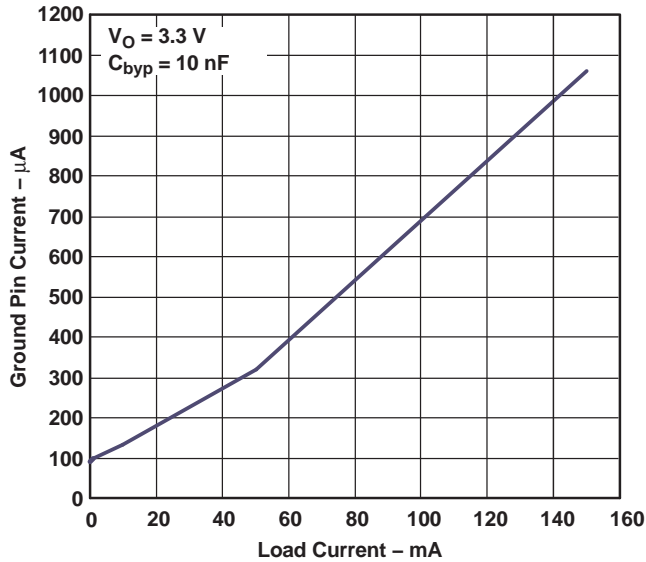

Figure 8.

RIPPLE REJECTION

vs
FREQUENCY

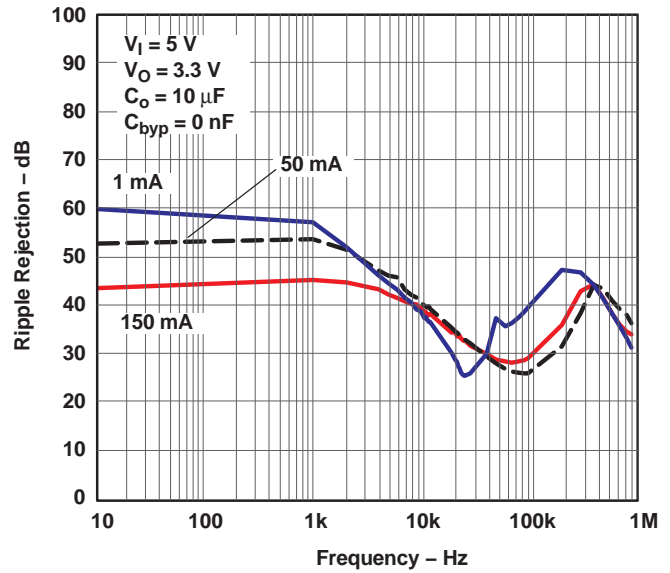

Figure 9.

TYPICAL PERFORMANCE CHARACTERISTICS (continued)

$C_{IN} = 1 \mu\text{F}$, $C_{OUT} = 4.7 \mu\text{F}$, $V_{IN} = V_{OUT(NOM)} + 1 \text{ V}$, $T_A = 25^\circ\text{C}$, ON/OFF pin tied to V_{IN} (unless otherwise specified)

**RIPPLE REJECTION
vs
FREQUENCY**

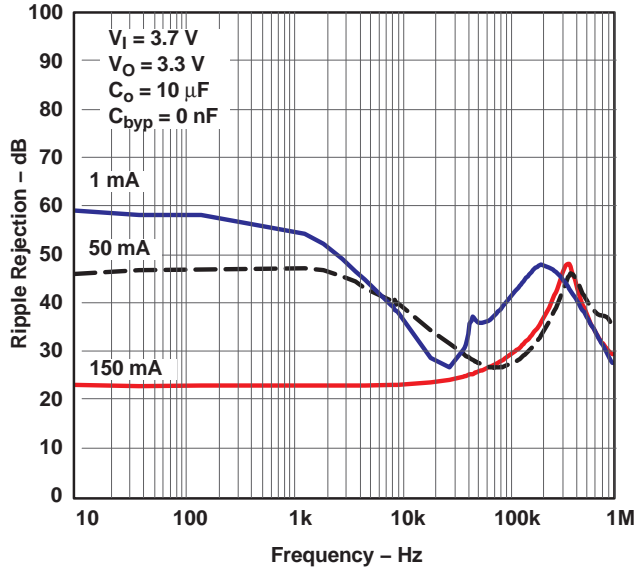

Figure 10.

**RIPPLE REJECTION
vs
FREQUENCY**

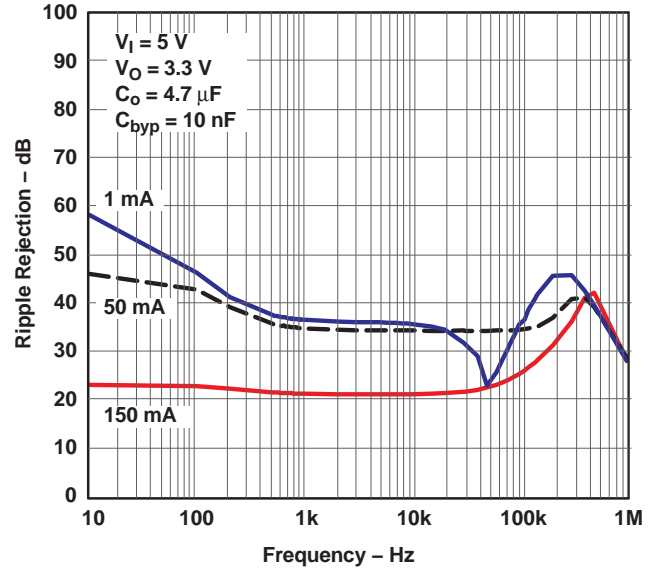

Figure 11.

**RIPPLE REJECTION
vs
FREQUENCY**

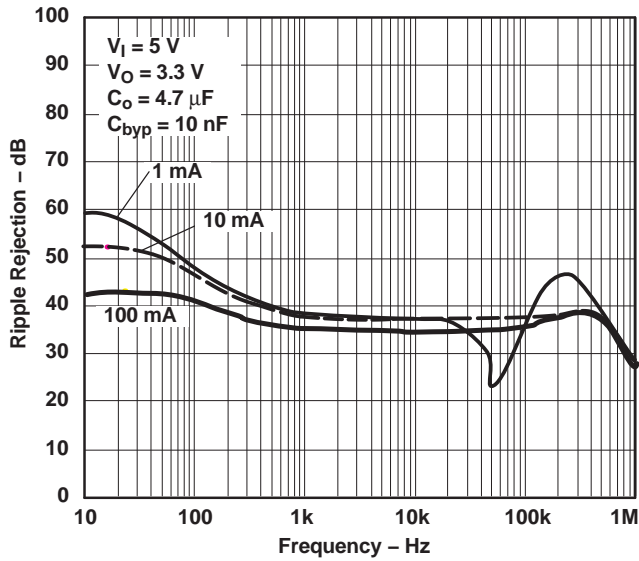

Figure 12.

**OUTPUT IMPEDANCE
vs
FREQUENCY**

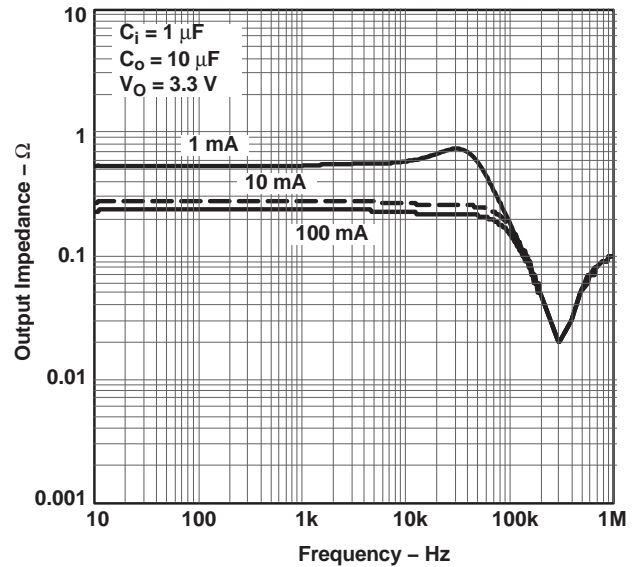

Figure 13.

TYPICAL PERFORMANCE CHARACTERISTICS (continued)

$C_{IN} = 1 \mu F$, $C_{OUT} = 4.7 \mu F$, $V_{IN} = V_{OUT(NOM)} + 1 V$, $T_A = 25^\circ C$, ON/OFF pin tied to V_{IN} (unless otherwise specified)

**OUTPUT IMPEDANCE
vs
FREQUENCY**

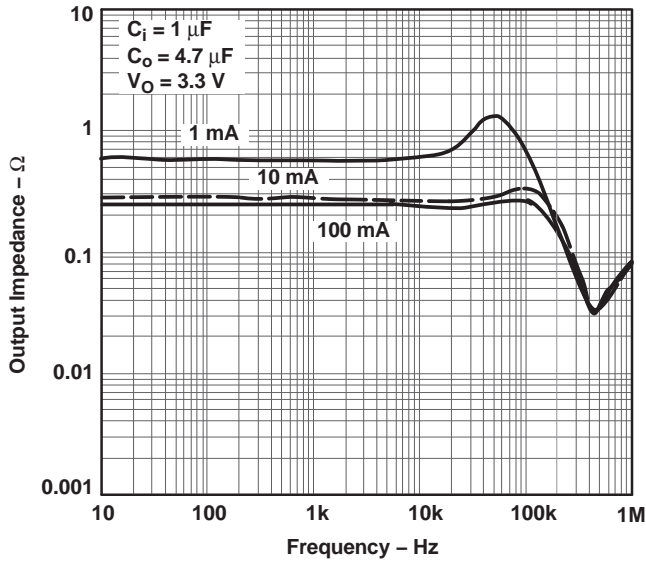

Figure 14.

**OUTPUT NOISE DENSITY
vs
FREQUENCY**

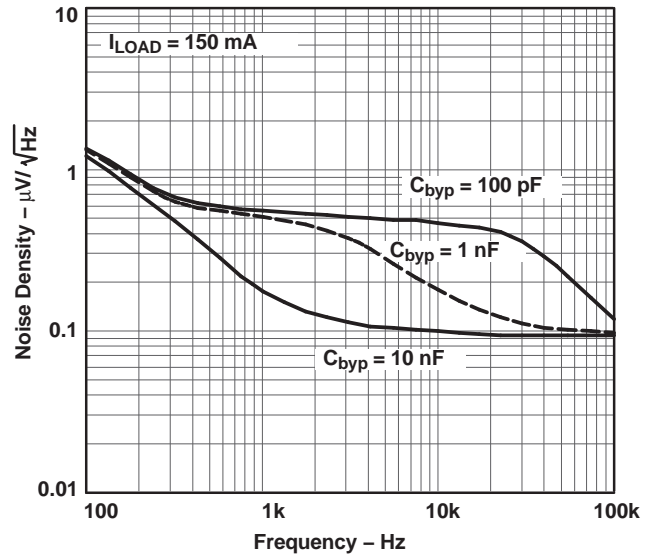

Figure 15.

**OUTPUT NOISE DENSITY
vs
FREQUENCY**

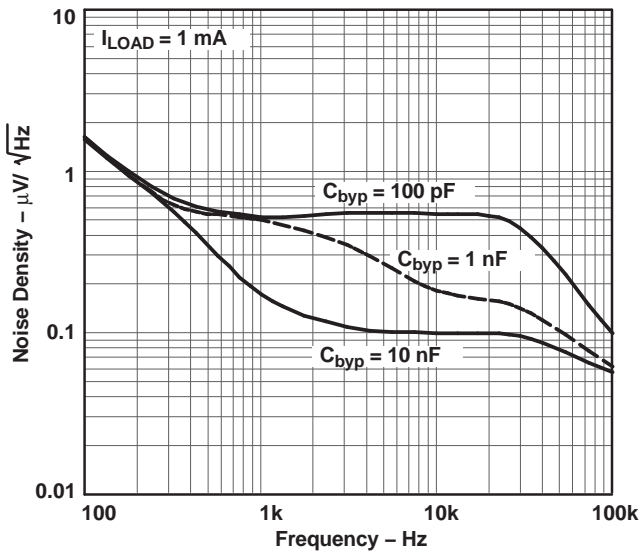

Figure 16.

**INPUT CURRENT
vs
INPUT VOLTAGE**

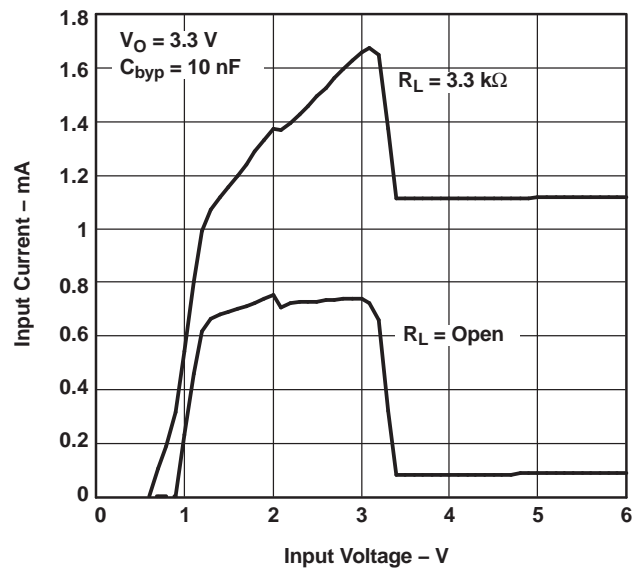

Figure 17.

TYPICAL PERFORMANCE CHARACTERISTICS (continued)

$C_{IN} = 1 \mu F$, $C_{OUT} = 4.7 \mu F$, $V_{IN} = V_{OUT(NOM)} + 1 V$, $T_A = 25^\circ C$, ON/OFF pin tied to V_{IN} (unless otherwise specified)

GROUND-PIN CURRENT

vs
TEMPERATURE

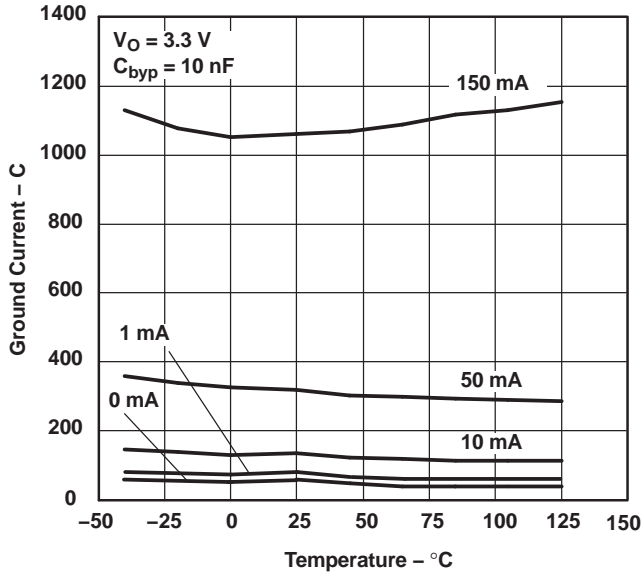

Figure 18.

LOAD TRANSIENT RESPONSE

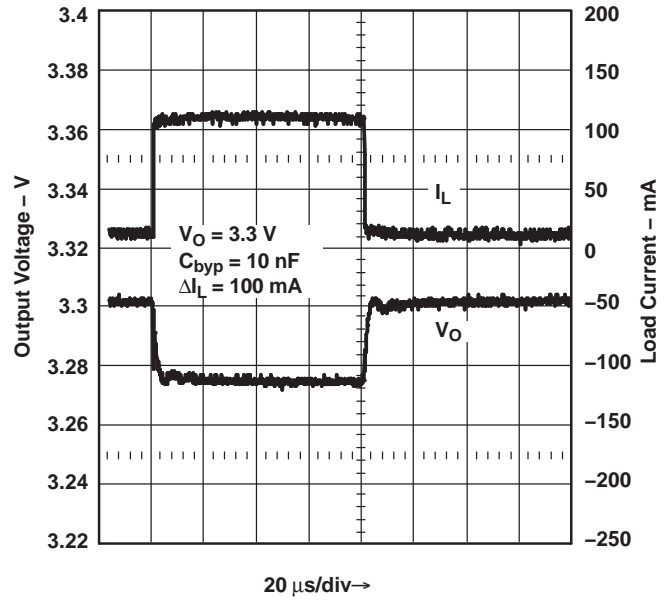

Figure 19.

LOAD TRANSIENT RESPONSE

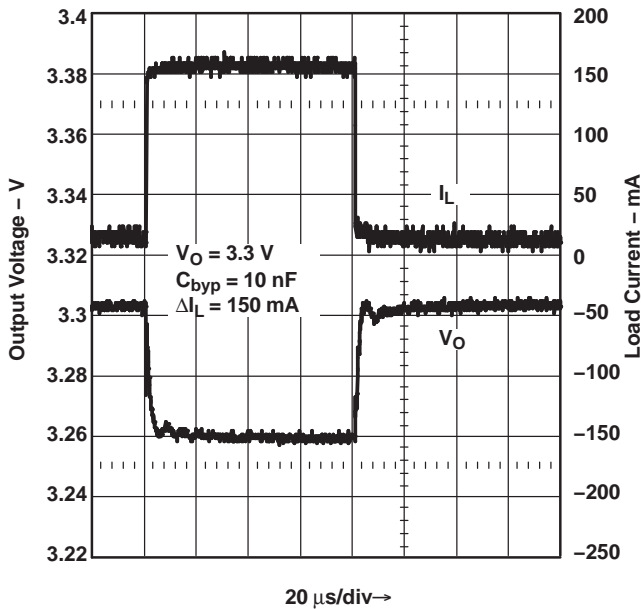

Figure 20.

LOAD TRANSIENT RESPONSE

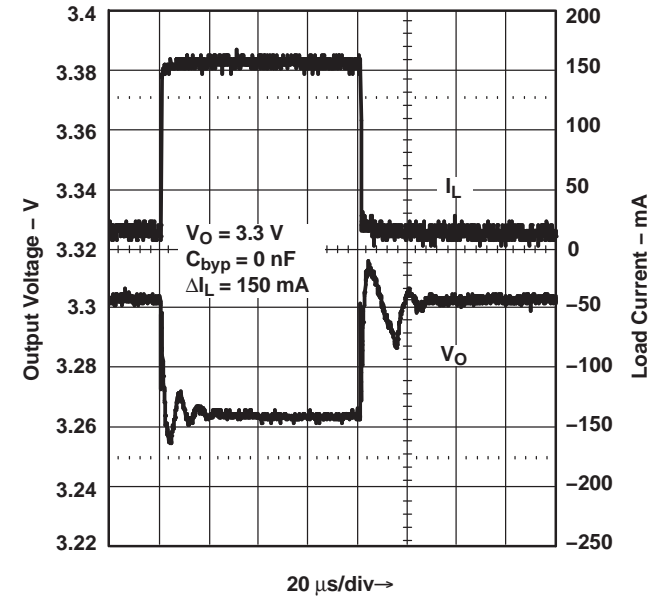
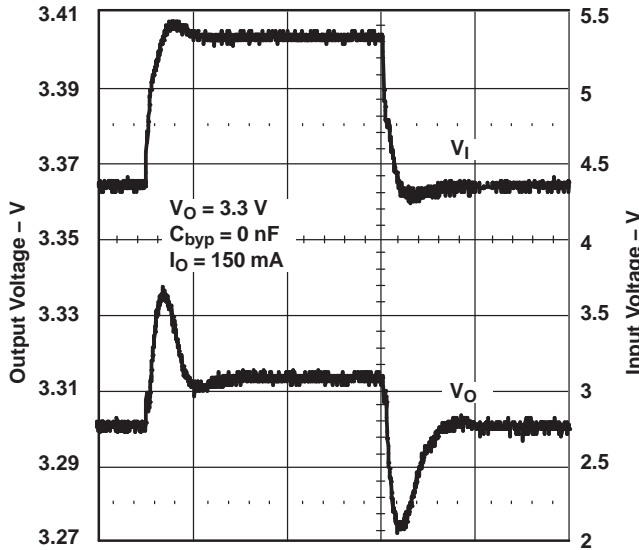

Figure 21.

TYPICAL PERFORMANCE CHARACTERISTICS (continued)

$C_{IN} = 1 \mu F$, $C_{OUT} = 4.7 \mu F$, $V_{IN} = V_{OUT(NOM)} + 1 V$, $T_A = 25^\circ C$, ON/OFF pin tied to V_{IN} (unless otherwise specified)

LINE TRANSIENT RESPONSE



20 $\mu s/div \rightarrow$

Figure 22.

LINE TRANSIENT RESPONSE

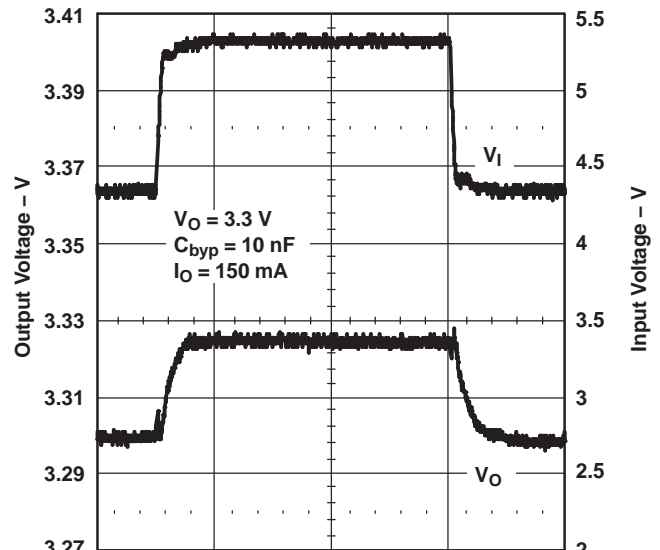

20 $\mu s/div \rightarrow$

Figure 23.

LINE TRANSIENT RESPONSE

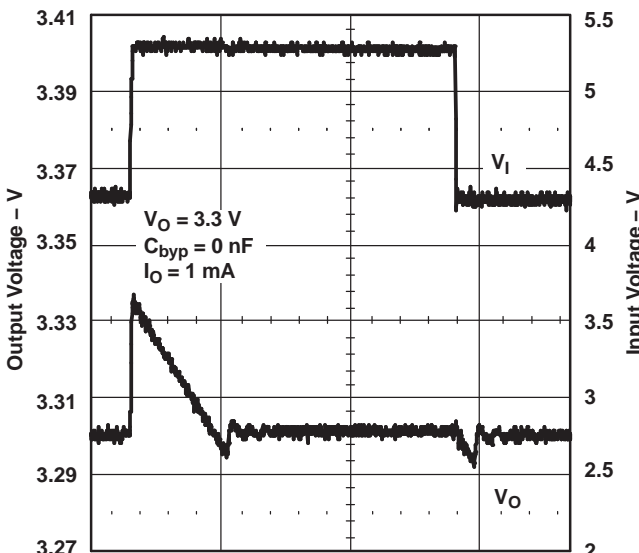

20 $\mu s/div \rightarrow$

Figure 24.

LINE TRANSIENT RESPONSE

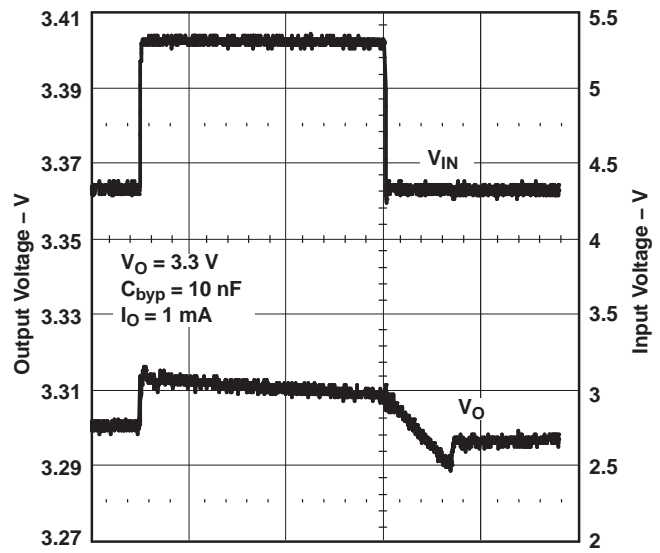

100 $\mu s/div \rightarrow$

Figure 25.

TYPICAL PERFORMANCE CHARACTERISTICS (continued)

$C_{IN} = 1 \mu F$, $C_{OUT} = 4.7 \mu F$, $V_{IN} = V_{OUT(NOM)} + 1 V$, $T_A = 25^\circ C$, ON/OFF pin tied to V_{IN} (unless otherwise specified)

TURN-ON TIME

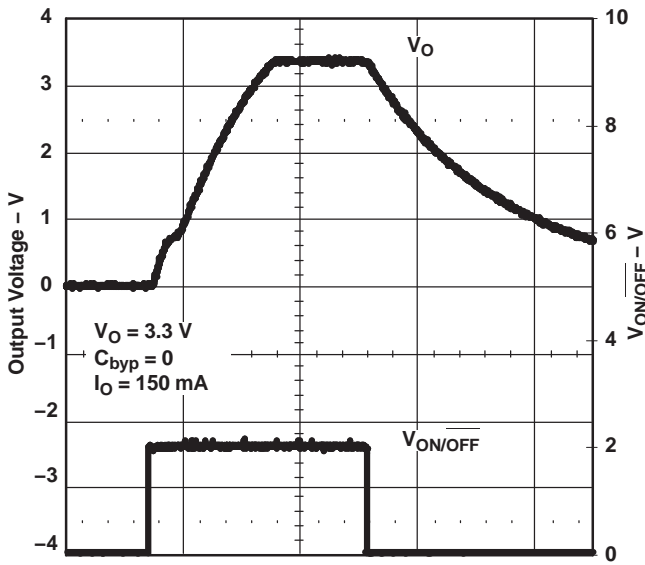

100 $\mu s/div \rightarrow$

Figure 26.

TURN-ON TIME

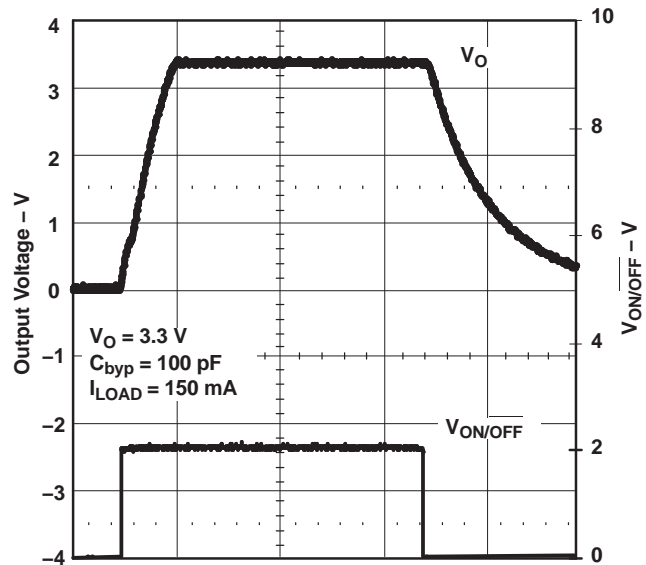

200 $\mu s/div \rightarrow$

Figure 27.

TURN-ON TIME

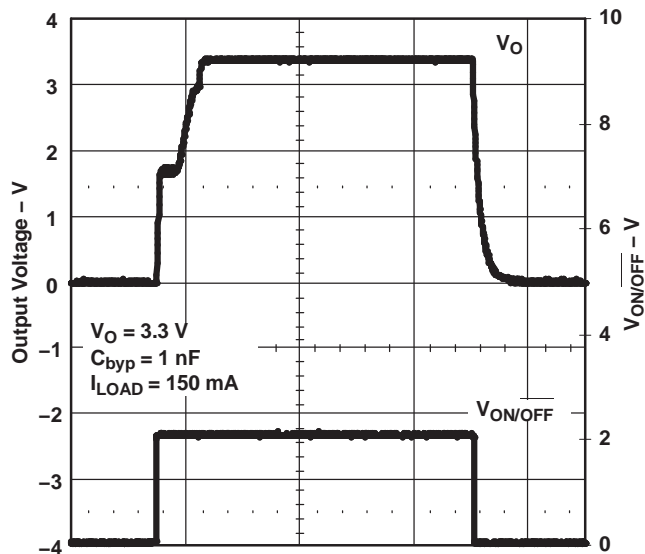

2 ms/div \rightarrow

Figure 28.

TURN-ON TIME

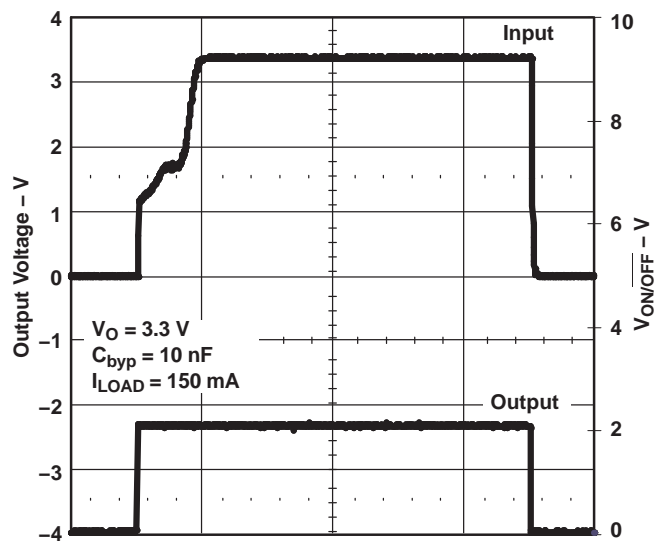

20 ms/div \rightarrow

Figure 29.

APPLICATION INFORMATION

Capacitors

Input Capacitor (C_{IN})

A minimum value of 1 μF (over the entire operating temperature range) is required at the input of the LP2985. In addition, this input capacitor should be located within 1 cm of the input pin and connected to a clean analog ground. There are no equivalent series resistance (ESR) requirements for this capacitor, and the capacitance can be increased without limit.

Output Capacitor (C_{OUT})

As an advantage over other regulators, the LP2985 permits the use of low-ESR capacitors at the output, including ceramic capacitors that can have an ESR as low as 5 m Ω . Tantalum and film capacitors also can be used if size and cost are not issues. The output capacitor also should be located within 1 cm of the output pin and be returned to a clean analog ground.

As with other PNP LDOs, stability conditions require the output capacitor to have a minimum capacitance and an ESR that falls within a certain range.

- Minimum C_{OUT} : 2.2 μF (can be increased without limit to improve transient response stability margin)
- ESR range: see [Figure 30](#) through [Figure 32](#)

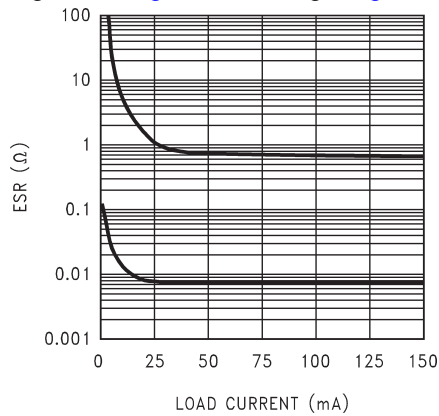

Figure 30. 2.2- μF Stable ESR Range for Output Voltage ≤ 2.3 V

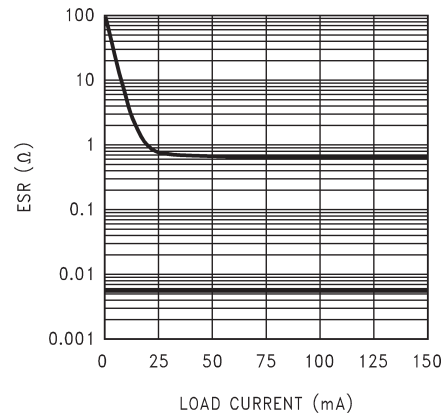

Figure 31. 4.7- μF Stable ESR Range for Output Voltage ≤ 2.3 V

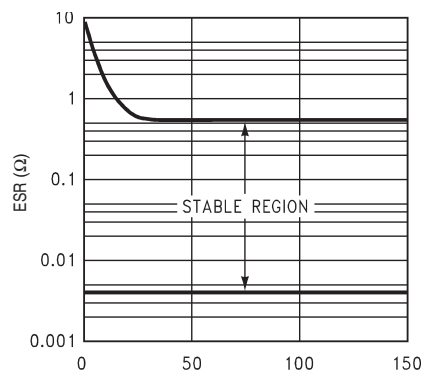

Figure 32. 2.2- μF /3.3- μF Stable ESR Range for Output Voltage ≥ 2.5 V

It is critical that both the minimum capacitance and ESR requirement be met *over the entire operating temperature range*. Depending on the type of capacitors used, both these parameters can vary significantly with temperature (see *capacitor characteristics*).

Noise Bypass Capacitor (C_{BYPASS})

The LP2985 allows for low-noise performance with the use of a bypass capacitor that is connected to the internal bandgap reference via the BYPASS pin. This high-impedance bandgap circuitry is biased in the microampere range and, thus, cannot be loaded significantly, otherwise, its output – and, correspondingly, the output of the regulator – changes. Thus, for best output accuracy, dc leakage current through C_{BYPASS} should be minimized as much as possible and never should exceed 100 nA.

A 10-nF capacitor is recommended for C_{BYPASS} . Ceramic and film capacitors are well suited for this purpose.

Capacitor Characteristics

Ceramics

Ceramic capacitors are ideal choices for use on the output of the LP2985 for several reasons. For capacitances in the range of 2.2 μF to 4.7 μF , ceramic capacitors have the lowest cost and the lowest ESR, making them choice candidates for filtering high-frequency noise. For instance, a typical 2.2- μF ceramic capacitor has an ESR in the range of 10 m Ω to 20 m Ω and, thus, satisfies minimum ESR requirements of the regulator.

Ceramic capacitors have one major disadvantage that must be taken into account – a poor temperature coefficient, where the capacitance can vary significantly with temperature. For instance, a large-value ceramic capacitor ($\geq 2.2 \mu\text{F}$) can lose more than half of its capacitance as the temperature rises from 25°C to 85°C. Thus, a 2.2- μF capacitor at 25°C drops well below the minimum C_{OUT} required for stability, as ambient temperature rises. For this reason, select an output capacitor that maintains the minimum 2.2 μF required for stability over the entire operating temperature range. Note that there are some ceramic capacitors that can maintain a $\pm 15\%$ capacitance tolerance over temperature.

Tantalum

Tantalum capacitors can be used at the output of the LP2985, but there are significant disadvantages that could prohibit their use:

- In the 1- μF to 4.7- μF range, tantalum capacitors are more expensive than ceramics of the equivalent capacitance and voltage ratings.
- Tantalum capacitors have higher ESRs than their equivalent-sized ceramic counterparts. Thus, to meet the ESR requirements, a higher-capacitance tantalum may be required, at the expense of larger size and higher cost.
- The ESR of a tantalum capacitor increases as temperature drops, as much as double from 25°C to –40°C. Thus, ESR margins must be maintained over the temperature range to prevent regulator instability.

ON/OFF Operation

The LP2985 allows for a shutdown mode via the ON/OFF pin. Driving the pin LOW ($\leq 0.3 \text{ V}$) turns the device OFF; conversely, a HIGH ($\geq 1.6 \text{ V}$) turns the device ON. If the shutdown feature is not used, ON/OFF should be connected to the input to ensure that the regulator is on at all times. For proper operation, do not leave ON/OFF unconnected, and apply a signal with a slew rate of $\geq 40 \text{ mV}/\mu\text{s}$.

Reverse Input-Output Voltage

There is an inherent diode present across the PNP pass element of the LP2985.

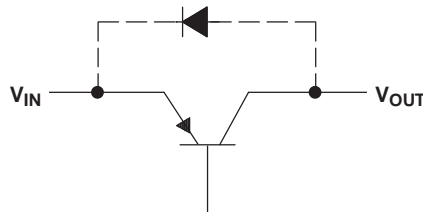

With the anode connected to the output, this diode is reverse biased during normal operation, since the input voltage is higher than the output. However, if the output is pulled higher than the input for any reason, this diode

is forward biased and can cause a parasitic silicon-controlled rectifier (SCR) to latch, resulting in high current flowing from the output to the input. Thus, to prevent possible damage to the regulator in any application where the output may be pulled above the input, an external Schottky diode should be connected between the output and input. With the anode on output, this Schottky limits the reverse voltage across the output and input pins to ~ 0.3 V, preventing the regulator's internal diode from forward biasing.

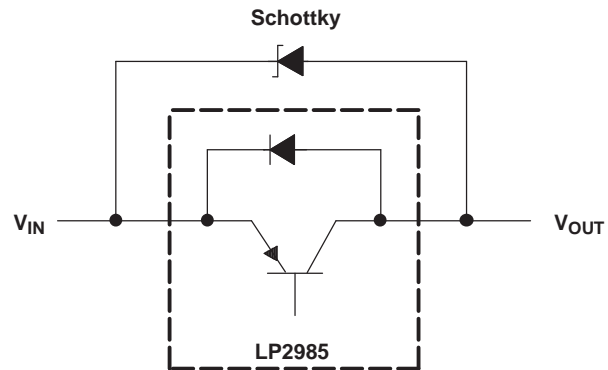

PACKAGING INFORMATION

Orderable Device	Status ⁽¹⁾	Package Type	Package Drawing	Pins	Package Qty	Eco Plan ⁽²⁾	Lead/ Ball Finish	MSL Peak Temp ⁽³⁾	Samples (Requires Login)
LP2985-10DBVR	ACTIVE	SOT-23	DBV	5	3000	Green (RoHS & no Sb/Br)	CU NIPDAU	Level-1-260C-UNLIM	
LP2985-10DBVT	ACTIVE	SOT-23	DBV	5	250	Green (RoHS & no Sb/Br)	CU NIPDAU	Level-1-260C-UNLIM	
LP2985-18DBVR	ACTIVE	SOT-23	DBV	5	3000	Green (RoHS & no Sb/Br)	CU NIPDAU	Level-1-260C-UNLIM	
LP2985-18DBVRE4	ACTIVE	SOT-23	DBV	5	3000	Green (RoHS & no Sb/Br)	CU NIPDAU	Level-1-260C-UNLIM	
LP2985-18DBVRG4	ACTIVE	SOT-23	DBV	5	3000	Green (RoHS & no Sb/Br)	CU NIPDAU	Level-1-260C-UNLIM	
LP2985-18DBVT	ACTIVE	SOT-23	DBV	5	250	Green (RoHS & no Sb/Br)	CU NIPDAU	Level-1-260C-UNLIM	
LP2985-18DBVTE4	ACTIVE	SOT-23	DBV	5	250	Green (RoHS & no Sb/Br)	CU NIPDAU	Level-1-260C-UNLIM	
LP2985-18DBVTG4	ACTIVE	SOT-23	DBV	5	250	Green (RoHS & no Sb/Br)	CU NIPDAU	Level-1-260C-UNLIM	
LP2985-25DBVR	ACTIVE	SOT-23	DBV	5	3000	Green (RoHS & no Sb/Br)	CU NIPDAU	Level-1-260C-UNLIM	
LP2985-25DBVRG4	ACTIVE	SOT-23	DBV	5	3000	Green (RoHS & no Sb/Br)	CU NIPDAU	Level-1-260C-UNLIM	
LP2985-25DBVT	ACTIVE	SOT-23	DBV	5	250	Green (RoHS & no Sb/Br)	CU NIPDAU	Level-1-260C-UNLIM	
LP2985-25DBVTG4	ACTIVE	SOT-23	DBV	5	250	Green (RoHS & no Sb/Br)	CU NIPDAU	Level-1-260C-UNLIM	
LP2985-28DBVR	ACTIVE	SOT-23	DBV	5	3000	Green (RoHS & no Sb/Br)	CU NIPDAU	Level-1-260C-UNLIM	
LP2985-28DBVRE4	ACTIVE	SOT-23	DBV	5	3000	Green (RoHS & no Sb/Br)	CU NIPDAU	Level-1-260C-UNLIM	
LP2985-28DBVRG4	ACTIVE	SOT-23	DBV	5	3000	Green (RoHS & no Sb/Br)	CU NIPDAU	Level-1-260C-UNLIM	
LP2985-28DBVT	ACTIVE	SOT-23	DBV	5	250	Green (RoHS & no Sb/Br)	CU NIPDAU	Level-1-260C-UNLIM	
LP2985-28DBVTE4	ACTIVE	SOT-23	DBV	5	250	Green (RoHS & no Sb/Br)	CU NIPDAU	Level-1-260C-UNLIM	

Orderable Device	Status ⁽¹⁾	Package Type	Package Drawing	Pins	Package Qty	Eco Plan ⁽²⁾	Lead/ Ball Finish	MSL Peak Temp ⁽³⁾	Samples (Requires Login)
LP2985-28DBVTG4	ACTIVE	SOT-23	DBV	5	250	Green (RoHS & no Sb/Br)	CU NIPDAU	Level-1-260C-UNLIM	
LP2985-29DBVR	ACTIVE	SOT-23	DBV	5	3000	Green (RoHS & no Sb/Br)	CU NIPDAU	Level-1-260C-UNLIM	
LP2985-29DBVRG4	ACTIVE	SOT-23	DBV	5	3000	Green (RoHS & no Sb/Br)	CU NIPDAU	Level-1-260C-UNLIM	
LP2985-29DBVT	ACTIVE	SOT-23	DBV	5	250	Green (RoHS & no Sb/Br)	CU NIPDAU	Level-1-260C-UNLIM	
LP2985-29DBVTG4	ACTIVE	SOT-23	DBV	5	250	Green (RoHS & no Sb/Br)	CU NIPDAU	Level-1-260C-UNLIM	
LP2985-30DBVR	ACTIVE	SOT-23	DBV	5	3000	Green (RoHS & no Sb/Br)	CU NIPDAU	Level-1-260C-UNLIM	
LP2985-30DBVRG4	ACTIVE	SOT-23	DBV	5	3000	Green (RoHS & no Sb/Br)	CU NIPDAU	Level-1-260C-UNLIM	
LP2985-30DBVT	ACTIVE	SOT-23	DBV	5	250	Green (RoHS & no Sb/Br)	CU NIPDAU	Level-1-260C-UNLIM	
LP2985-30DBVTG4	ACTIVE	SOT-23	DBV	5	250	Green (RoHS & no Sb/Br)	CU NIPDAU	Level-1-260C-UNLIM	
LP2985-33DBVR	ACTIVE	SOT-23	DBV	5	3000	Green (RoHS & no Sb/Br)	CU NIPDAU	Level-1-260C-UNLIM	
LP2985-33DBVRE4	ACTIVE	SOT-23	DBV	5	3000	Green (RoHS & no Sb/Br)	CU NIPDAU	Level-1-260C-UNLIM	
LP2985-33DBVRG4	ACTIVE	SOT-23	DBV	5	3000	Green (RoHS & no Sb/Br)	CU NIPDAU	Level-1-260C-UNLIM	
LP2985-33DBVT	ACTIVE	SOT-23	DBV	5	250	Green (RoHS & no Sb/Br)	CU NIPDAU	Level-1-260C-UNLIM	
LP2985-33DBVTE4	ACTIVE	SOT-23	DBV	5	250	Green (RoHS & no Sb/Br)	CU NIPDAU	Level-1-260C-UNLIM	
LP2985-33DBVTG4	ACTIVE	SOT-23	DBV	5	250	Green (RoHS & no Sb/Br)	CU NIPDAU	Level-1-260C-UNLIM	
LP2985-50DBVR	ACTIVE	SOT-23	DBV	5	3000	Green (RoHS & no Sb/Br)	CU NIPDAU	Level-1-260C-UNLIM	
LP2985-50DBVRG4	ACTIVE	SOT-23	DBV	5	3000	Green (RoHS & no Sb/Br)	CU NIPDAU	Level-1-260C-UNLIM	
LP2985-50DBVT	ACTIVE	SOT-23	DBV	5	250	Green (RoHS & no Sb/Br)	CU NIPDAU	Level-1-260C-UNLIM	

Orderable Device	Status ⁽¹⁾	Package Type	Package Drawing	Pins	Package Qty	Eco Plan ⁽²⁾	Lead/ Ball Finish	MSL Peak Temp ⁽³⁾	Samples (Requires Login)
LP2985-50DBVTG4	ACTIVE	SOT-23	DBV	5	250	Green (RoHS & no Sb/Br)	CU NIPDAU	Level-1-260C-UNLIM	
LP2985A-10DBVR	ACTIVE	SOT-23	DBV	5	3000	Green (RoHS & no Sb/Br)	CU NIPDAU	Level-1-260C-UNLIM	
LP2985A-10DBVT	ACTIVE	SOT-23	DBV	5	250	Green (RoHS & no Sb/Br)	CU NIPDAU	Level-1-260C-UNLIM	
LP2985A-18DBVJ	ACTIVE	SOT-23	DBV	5	10000	Green (RoHS & no Sb/Br)	CU NIPDAU	Level-1-260C-UNLIM	
LP2985A-18DBVR	ACTIVE	SOT-23	DBV	5	3000	Green (RoHS & no Sb/Br)	CU NIPDAU	Level-1-260C-UNLIM	
LP2985A-18DBVRE4	ACTIVE	SOT-23	DBV	5	3000	Green (RoHS & no Sb/Br)	CU NIPDAU	Level-1-260C-UNLIM	
LP2985A-18DBVRG4	ACTIVE	SOT-23	DBV	5	3000	Green (RoHS & no Sb/Br)	CU NIPDAU	Level-1-260C-UNLIM	
LP2985A-18DBVT	ACTIVE	SOT-23	DBV	5	250	Green (RoHS & no Sb/Br)	CU NIPDAU	Level-1-260C-UNLIM	
LP2985A-18DBVTE4	ACTIVE	SOT-23	DBV	5	250	Green (RoHS & no Sb/Br)	CU NIPDAU	Level-1-260C-UNLIM	
LP2985A-18DBVTG4	ACTIVE	SOT-23	DBV	5	250	Green (RoHS & no Sb/Br)	CU NIPDAU	Level-1-260C-UNLIM	
LP2985A-25DBVR	ACTIVE	SOT-23	DBV	5	3000	Green (RoHS & no Sb/Br)	CU NIPDAU	Level-1-260C-UNLIM	
LP2985A-25DBVRG4	ACTIVE	SOT-23	DBV	5	3000	Green (RoHS & no Sb/Br)	CU NIPDAU	Level-1-260C-UNLIM	
LP2985A-25DBVT	ACTIVE	SOT-23	DBV	5	250	Green (RoHS & no Sb/Br)	CU NIPDAU	Level-1-260C-UNLIM	
LP2985A-25DBVTG4	ACTIVE	SOT-23	DBV	5	250	Green (RoHS & no Sb/Br)	CU NIPDAU	Level-1-260C-UNLIM	
LP2985A-28DBVR	ACTIVE	SOT-23	DBV	5	3000	Green (RoHS & no Sb/Br)	CU NIPDAU	Level-1-260C-UNLIM	
LP2985A-28DBVRE4	ACTIVE	SOT-23	DBV	5	3000	Green (RoHS & no Sb/Br)	CU NIPDAU	Level-1-260C-UNLIM	
LP2985A-28DBVRG4	ACTIVE	SOT-23	DBV	5	3000	Green (RoHS & no Sb/Br)	CU NIPDAU	Level-1-260C-UNLIM	
LP2985A-28DBVT	ACTIVE	SOT-23	DBV	5	250	Green (RoHS & no Sb/Br)	CU NIPDAU	Level-1-260C-UNLIM	

Orderable Device	Status ⁽¹⁾	Package Type	Package Drawing	Pins	Package Qty	Eco Plan ⁽²⁾	Lead/ Ball Finish	MSL Peak Temp ⁽³⁾	Samples (Requires Login)
LP2985A-28DBVTE4	ACTIVE	SOT-23	DBV	5	250	Green (RoHS & no Sb/Br)	CU NIPDAU	Level-1-260C-UNLIM	
LP2985A-28DBVTG4	ACTIVE	SOT-23	DBV	5	250	Green (RoHS & no Sb/Br)	CU NIPDAU	Level-1-260C-UNLIM	
LP2985A-29DBVR	ACTIVE	SOT-23	DBV	5	3000	Green (RoHS & no Sb/Br)	CU NIPDAU	Level-1-260C-UNLIM	
LP2985A-29DBVRG4	ACTIVE	SOT-23	DBV	5	3000	Green (RoHS & no Sb/Br)	CU NIPDAU	Level-1-260C-UNLIM	
LP2985A-29DBVT	ACTIVE	SOT-23	DBV	5	250	Green (RoHS & no Sb/Br)	CU NIPDAU	Level-1-260C-UNLIM	
LP2985A-29DBVTG4	ACTIVE	SOT-23	DBV	5	250	Green (RoHS & no Sb/Br)	CU NIPDAU	Level-1-260C-UNLIM	
LP2985A-30DBVR	ACTIVE	SOT-23	DBV	5	3000	Green (RoHS & no Sb/Br)	CU NIPDAU	Level-1-260C-UNLIM	
LP2985A-30DBVRG4	ACTIVE	SOT-23	DBV	5	3000	Green (RoHS & no Sb/Br)	CU NIPDAU	Level-1-260C-UNLIM	
LP2985A-30DBVT	ACTIVE	SOT-23	DBV	5	250	Green (RoHS & no Sb/Br)	CU NIPDAU	Level-1-260C-UNLIM	
LP2985A-30DBVTG4	ACTIVE	SOT-23	DBV	5	250	Green (RoHS & no Sb/Br)	CU NIPDAU	Level-1-260C-UNLIM	
LP2985A-33DBVR	ACTIVE	SOT-23	DBV	5	3000	Green (RoHS & no Sb/Br)	CU NIPDAU	Level-1-260C-UNLIM	
LP2985A-33DBVRE4	ACTIVE	SOT-23	DBV	5	3000	Green (RoHS & no Sb/Br)	CU NIPDAU	Level-1-260C-UNLIM	
LP2985A-33DBVRG4	ACTIVE	SOT-23	DBV	5	3000	Green (RoHS & no Sb/Br)	CU NIPDAU	Level-1-260C-UNLIM	
LP2985A-33DBVT	ACTIVE	SOT-23	DBV	5	250	Green (RoHS & no Sb/Br)	CU NIPDAU	Level-1-260C-UNLIM	
LP2985A-33DBVTE4	ACTIVE	SOT-23	DBV	5	250	Green (RoHS & no Sb/Br)	CU NIPDAU	Level-1-260C-UNLIM	
LP2985A-33DBVTG4	ACTIVE	SOT-23	DBV	5	250	Green (RoHS & no Sb/Br)	CU NIPDAU	Level-1-260C-UNLIM	
LP2985A-50DBVR	ACTIVE	SOT-23	DBV	5	3000	Green (RoHS & no Sb/Br)	CU NIPDAU	Level-1-260C-UNLIM	
LP2985A-50DBVRG4	ACTIVE	SOT-23	DBV	5	3000	Green (RoHS & no Sb/Br)	CU NIPDAU	Level-1-260C-UNLIM	

Orderable Device	Status ⁽¹⁾	Package Type	Package Drawing	Pins	Package Qty	Eco Plan ⁽²⁾	Lead/ Ball Finish	MSL Peak Temp ⁽³⁾	Samples (Requires Login)
LP2985A-50DBVT	ACTIVE	SOT-23	DBV	5	250	Green (RoHS & no Sb/Br)	CU NIPDAU	Level-1-260C-UNLIM	
LP2985A-50DBVTG4	ACTIVE	SOT-23	DBV	5	250	Green (RoHS & no Sb/Br)	CU NIPDAU	Level-1-260C-UNLIM	

⁽¹⁾ The marketing status values are defined as follows:

ACTIVE: Product device recommended for new designs.

LIFEBUY: TI has announced that the device will be discontinued, and a lifetime-buy period is in effect.

NRND: Not recommended for new designs. Device is in production to support existing customers, but TI does not recommend using this part in a new design.

PREVIEW: Device has been announced but is not in production. Samples may or may not be available.

OBSELETE: TI has discontinued the production of the device.

⁽²⁾ Eco Plan - The planned eco-friendly classification: Pb-Free (RoHS), Pb-Free (RoHS Exempt), or Green (RoHS & no Sb/Br) - please check <http://www.ti.com/productcontent> for the latest availability information and additional product content details.

TBD: The Pb-Free/Green conversion plan has not been defined.

Pb-Free (RoHS): TI's terms "Lead-Free" or "Pb-Free" mean semiconductor products that are compatible with the current RoHS requirements for all 6 substances, including the requirement that lead not exceed 0.1% by weight in homogeneous materials. Where designed to be soldered at high temperatures, TI Pb-Free products are suitable for use in specified lead-free processes.

Pb-Free (RoHS Exempt): This component has a RoHS exemption for either 1) lead-based flip-chip solder bumps used between the die and package, or 2) lead-based die adhesive used between the die and leadframe. The component is otherwise considered Pb-Free (RoHS compatible) as defined above.

Green (RoHS & no Sb/Br): TI defines "Green" to mean Pb-Free (RoHS compatible), and free of Bromine (Br) and Antimony (Sb) based flame retardants (Br or Sb do not exceed 0.1% by weight in homogeneous material)

⁽³⁾ MSL, Peak Temp. -- The Moisture Sensitivity Level rating according to the JEDEC industry standard classifications, and peak solder temperature.

Important Information and Disclaimer: The information provided on this page represents TI's knowledge and belief as of the date that it is provided. TI bases its knowledge and belief on information provided by third parties, and makes no representation or warranty as to the accuracy of such information. Efforts are underway to better integrate information from third parties. TI has taken and continues to take reasonable steps to provide representative and accurate information but may not have conducted destructive testing or chemical analysis on incoming materials and chemicals. TI and TI suppliers consider certain information to be proprietary, and thus CAS numbers and other limited information may not be available for release.

In no event shall TI's liability arising out of such information exceed the total purchase price of the TI part(s) at issue in this document sold by TI to Customer on an annual basis.

TAPE AND REEL INFORMATION

REEL DIMENSIONS

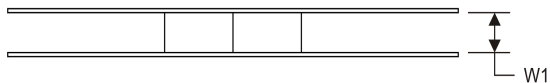
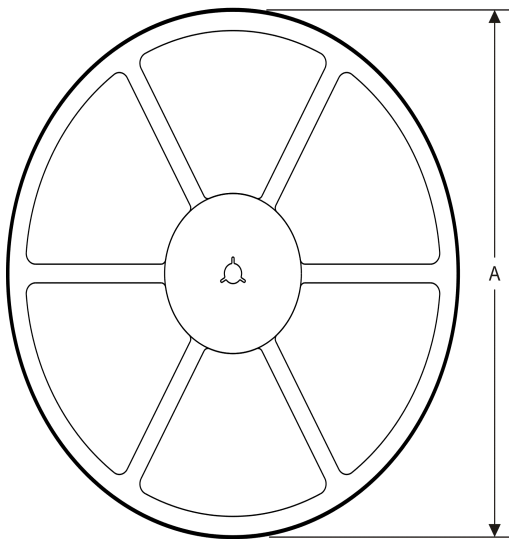

TAPE DIMENSIONS

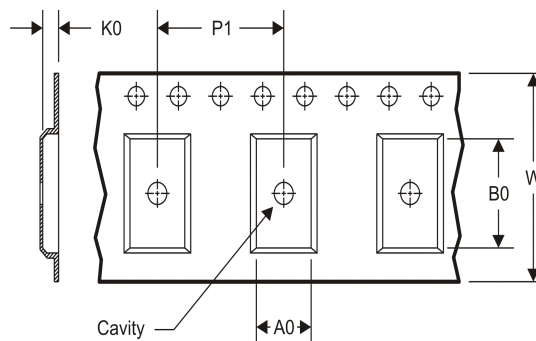

A0	Dimension designed to accommodate the component width
B0	Dimension designed to accommodate the component length
K0	Dimension designed to accommodate the component thickness
W	Overall width of the carrier tape
P1	Pitch between successive cavity centers

TAPE AND REEL INFORMATION

*All dimensions are nominal

Device	Package Type	Package Drawing	Pins	SPQ	Reel Diameter (mm)	Reel Width W1 (mm)	A0 (mm)	B0 (mm)	K0 (mm)	P1 (mm)	W (mm)	Pin1 Quadrant
LP2985-10DBVR	SOT-23	DBV	5	3000	178.0	9.0	3.23	3.17	1.37	4.0	8.0	Q3
LP2985-10DBVT	SOT-23	DBV	5	250	178.0	9.0	3.23	3.17	1.37	4.0	8.0	Q3
LP2985-18DBVR	SOT-23	DBV	5	3000	180.0	9.2	3.17	3.23	1.37	4.0	8.0	Q3
LP2985-18DBVT	SOT-23	DBV	5	3000	178.0	9.0	3.23	3.17	1.37	4.0	8.0	Q3
LP2985-18DBVT	SOT-23	DBV	5	250	180.0	9.2	3.17	3.23	1.37	4.0	8.0	Q3
LP2985-25DBVR	SOT-23	DBV	5	3000	180.0	9.2	3.17	3.23	1.37	4.0	8.0	Q3
LP2985-25DBVT	SOT-23	DBV	5	250	180.0	9.2	3.17	3.23	1.37	4.0	8.0	Q3
LP2985-25DBVT	SOT-23	DBV	5	250	180.0	9.2	3.17	3.23	1.37	4.0	8.0	Q3
LP2985-28DBVR	SOT-23	DBV	5	3000	178.0	9.0	3.23	3.17	1.37	4.0	8.0	Q3
LP2985-28DBVT	SOT-23	DBV	5	3000	180.0	9.2	3.17	3.23	1.37	4.0	8.0	Q3
LP2985-28DBVT	SOT-23	DBV	5	250	180.0	9.2	3.17	3.23	1.37	4.0	8.0	Q3
LP2985-29DBVR	SOT-23	DBV	5	3000	178.0	9.0	3.23	3.17	1.37	4.0	8.0	Q3
LP2985-29DBVT	SOT-23	DBV	5	3000	180.0	9.2	3.17	3.23	1.37	4.0	8.0	Q3
LP2985-29DBVT	SOT-23	DBV	5	250	180.0	9.2	3.17	3.23	1.37	4.0	8.0	Q3
LP2985-30DBVR	SOT-23	DBV	5	3000	180.0	9.2	3.17	3.23	1.37	4.0	8.0	Q3
LP2985-30DBVT	SOT-23	DBV	5	3000	178.0	9.0	3.23	3.17	1.37	4.0	8.0	Q3
LP2985-30DBVT	SOT-23	DBV	5	250	180.0	9.2	3.17	3.23	1.37	4.0	8.0	Q3
LP2985-33DBVR	SOT-23	DBV	5	3000	180.0	9.2	3.17	3.23	1.37	4.0	8.0	Q3

Device	Package Type	Package Drawing	Pins	SPQ	Reel Diameter (mm)	Reel Width W1 (mm)	A0 (mm)	B0 (mm)	K0 (mm)	P1 (mm)	W (mm)	Pin1 Quadrant
LP2985-33DBVR	SOT-23	DBV	5	3000	178.0	9.0	3.23	3.17	1.37	4.0	8.0	Q3
LP2985-33DBVT	SOT-23	DBV	5	250	178.0	9.0	3.23	3.17	1.37	4.0	8.0	Q3
LP2985-33DBVT	SOT-23	DBV	5	250	180.0	9.2	3.17	3.23	1.37	4.0	8.0	Q3
LP2985-50DBVR	SOT-23	DBV	5	3000	180.0	9.2	3.17	3.23	1.37	4.0	8.0	Q3
LP2985-50DBVR	SOT-23	DBV	5	3000	178.0	9.0	3.23	3.17	1.37	4.0	8.0	Q3
LP2985-50DBVT	SOT-23	DBV	5	250	180.0	9.2	3.17	3.23	1.37	4.0	8.0	Q3
LP2985A-10DBVR	SOT-23	DBV	5	3000	178.0	9.0	3.23	3.17	1.37	4.0	8.0	Q3
LP2985A-10DBVT	SOT-23	DBV	5	250	178.0	9.0	3.23	3.17	1.37	4.0	8.0	Q3
LP2985A-18DBVJ	SOT-23	DBV	5	10000	330.0	8.4	3.17	3.23	1.37	4.0	8.0	Q3
LP2985A-18DBVR	SOT-23	DBV	5	3000	180.0	9.2	3.17	3.23	1.37	4.0	8.0	Q3
LP2985A-18DBVR	SOT-23	DBV	5	3000	178.0	9.0	3.23	3.17	1.37	4.0	8.0	Q3
LP2985A-18DBVT	SOT-23	DBV	5	250	180.0	9.2	3.17	3.23	1.37	4.0	8.0	Q3
LP2985A-25DBVR	SOT-23	DBV	5	3000	178.0	9.0	3.23	3.17	1.37	4.0	8.0	Q3
LP2985A-25DBVR	SOT-23	DBV	5	3000	180.0	9.2	3.17	3.23	1.37	4.0	8.0	Q3
LP2985A-25DBVT	SOT-23	DBV	5	250	180.0	9.2	3.17	3.23	1.37	4.0	8.0	Q3
LP2985A-28DBVR	SOT-23	DBV	5	3000	180.0	9.2	3.17	3.23	1.37	4.0	8.0	Q3
LP2985A-28DBVR	SOT-23	DBV	5	3000	178.0	9.0	3.23	3.17	1.37	4.0	8.0	Q3
LP2985A-28DBVT	SOT-23	DBV	5	250	180.0	9.2	3.17	3.23	1.37	4.0	8.0	Q3
LP2985A-29DBVR	SOT-23	DBV	5	3000	178.0	9.0	3.23	3.17	1.37	4.0	8.0	Q3
LP2985A-29DBVR	SOT-23	DBV	5	3000	180.0	9.2	3.17	3.23	1.37	4.0	8.0	Q3
LP2985A-29DBVT	SOT-23	DBV	5	250	180.0	9.2	3.17	3.23	1.37	4.0	8.0	Q3
LP2985A-30DBVR	SOT-23	DBV	5	3000	178.0	9.0	3.23	3.17	1.37	4.0	8.0	Q3
LP2985A-30DBVR	SOT-23	DBV	5	3000	180.0	9.2	3.17	3.23	1.37	4.0	8.0	Q3
LP2985A-30DBVT	SOT-23	DBV	5	250	180.0	9.2	3.17	3.23	1.37	4.0	8.0	Q3
LP2985A-33DBVR	SOT-23	DBV	5	3000	180.0	9.2	3.17	3.23	1.37	4.0	8.0	Q3
LP2985A-33DBVR	SOT-23	DBV	5	3000	178.0	9.0	3.23	3.17	1.37	4.0	8.0	Q3
LP2985A-33DBVT	SOT-23	DBV	5	250	178.0	9.0	3.23	3.17	1.37	4.0	8.0	Q3
LP2985A-33DBVT	SOT-23	DBV	5	250	180.0	9.2	3.17	3.23	1.37	4.0	8.0	Q3
LP2985A-50DBVR	SOT-23	DBV	5	3000	180.0	9.2	3.17	3.23	1.37	4.0	8.0	Q3
LP2985A-50DBVR	SOT-23	DBV	5	3000	178.0	9.0	3.23	3.17	1.37	4.0	8.0	Q3
LP2985A-50DBVT	SOT-23	DBV	5	250	180.0	9.2	3.17	3.23	1.37	4.0	8.0	Q3

TAPE AND REEL BOX DIMENSIONS

*All dimensions are nominal

Device	Package Type	Package Drawing	Pins	SPQ	Length (mm)	Width (mm)	Height (mm)
LP2985-10DBVR	SOT-23	DBV	5	3000	180.0	180.0	18.0
LP2985-10DBVT	SOT-23	DBV	5	250	180.0	180.0	18.0
LP2985-18DBVR	SOT-23	DBV	5	3000	205.0	200.0	33.0
LP2985-18DBVR	SOT-23	DBV	5	3000	180.0	180.0	18.0
LP2985-18DBVT	SOT-23	DBV	5	250	205.0	200.0	33.0
LP2985-25DBVR	SOT-23	DBV	5	3000	205.0	200.0	33.0
LP2985-25DBVR	SOT-23	DBV	5	3000	180.0	180.0	18.0
LP2985-25DBVT	SOT-23	DBV	5	250	205.0	200.0	33.0
LP2985-28DBVR	SOT-23	DBV	5	3000	180.0	180.0	18.0
LP2985-28DBVR	SOT-23	DBV	5	3000	205.0	200.0	33.0
LP2985-28DBVT	SOT-23	DBV	5	250	205.0	200.0	33.0
LP2985-29DBVR	SOT-23	DBV	5	3000	180.0	180.0	18.0
LP2985-29DBVR	SOT-23	DBV	5	3000	205.0	200.0	33.0
LP2985-29DBVT	SOT-23	DBV	5	250	205.0	200.0	33.0
LP2985-30DBVR	SOT-23	DBV	5	3000	205.0	200.0	33.0
LP2985-30DBVR	SOT-23	DBV	5	3000	180.0	180.0	18.0
LP2985-30DBVT	SOT-23	DBV	5	250	205.0	200.0	33.0
LP2985-33DBVR	SOT-23	DBV	5	3000	205.0	200.0	33.0
LP2985-33DBVR	SOT-23	DBV	5	3000	180.0	180.0	18.0
LP2985-33DBVT	SOT-23	DBV	5	250	180.0	180.0	18.0

Device	Package Type	Package Drawing	Pins	SPQ	Length (mm)	Width (mm)	Height (mm)
LP2985-33DBVT	SOT-23	DBV	5	250	205.0	200.0	33.0
LP2985-50DBVR	SOT-23	DBV	5	3000	205.0	200.0	33.0
LP2985-50DBVR	SOT-23	DBV	5	3000	180.0	180.0	18.0
LP2985-50DBVT	SOT-23	DBV	5	250	205.0	200.0	33.0
LP2985A-10DBVR	SOT-23	DBV	5	3000	180.0	180.0	18.0
LP2985A-10DBVT	SOT-23	DBV	5	250	180.0	180.0	18.0
LP2985A-18DBVJ	SOT-23	DBV	5	10000	358.0	332.0	35.0
LP2985A-18DBVR	SOT-23	DBV	5	3000	205.0	200.0	33.0
LP2985A-18DBVR	SOT-23	DBV	5	3000	180.0	180.0	18.0
LP2985A-18DBVT	SOT-23	DBV	5	250	205.0	200.0	33.0
LP2985A-25DBVR	SOT-23	DBV	5	3000	180.0	180.0	18.0
LP2985A-25DBVR	SOT-23	DBV	5	3000	205.0	200.0	33.0
LP2985A-25DBVT	SOT-23	DBV	5	250	205.0	200.0	33.0
LP2985A-28DBVR	SOT-23	DBV	5	3000	205.0	200.0	33.0
LP2985A-28DBVR	SOT-23	DBV	5	3000	180.0	180.0	18.0
LP2985A-28DBVT	SOT-23	DBV	5	250	205.0	200.0	33.0
LP2985A-29DBVR	SOT-23	DBV	5	3000	180.0	180.0	18.0
LP2985A-29DBVR	SOT-23	DBV	5	3000	205.0	200.0	33.0
LP2985A-29DBVT	SOT-23	DBV	5	250	205.0	200.0	33.0
LP2985A-30DBVR	SOT-23	DBV	5	3000	180.0	180.0	18.0
LP2985A-30DBVR	SOT-23	DBV	5	3000	205.0	200.0	33.0
LP2985A-30DBVT	SOT-23	DBV	5	250	205.0	200.0	33.0
LP2985A-33DBVR	SOT-23	DBV	5	3000	205.0	200.0	33.0
LP2985A-33DBVR	SOT-23	DBV	5	3000	180.0	180.0	18.0
LP2985A-33DBVT	SOT-23	DBV	5	250	180.0	180.0	18.0
LP2985A-33DBVT	SOT-23	DBV	5	250	205.0	200.0	33.0
LP2985A-50DBVR	SOT-23	DBV	5	3000	205.0	200.0	33.0
LP2985A-50DBVR	SOT-23	DBV	5	3000	180.0	180.0	18.0
LP2985A-50DBVT	SOT-23	DBV	5	250	205.0	200.0	33.0

DBV (R-PDSO-G5)

PLASTIC SMALL-OUTLINE PACKAGE



- NOTES:
- A. All linear dimensions are in millimeters.
 - B. This drawing is subject to change without notice.
 - C. Body dimensions do not include mold flash or protrusion. Mold flash and protrusion shall not exceed 0.15 per side.
 - D. Falls within JEDEC MO-178 Variation AA.

DBV (R-PDSO-G5)

PLASTIC SMALL OUTLINE



- NOTES:
- A. All linear dimensions are in millimeters.
 - B. This drawing is subject to change without notice.
 - C. Customers should place a note on the circuit board fabrication drawing not to alter the center solder mask defined pad.
 - D. Publication IPC-7351 is recommended for alternate designs.
 - E. Laser cutting apertures with trapezoidal walls and also rounding corners will offer better paste release. Customers should contact their board assembly site for stencil design recommendations. Example stencil design based on a 50% volumetric metal load solder paste. Refer to IPC-7525 for other stencil recommendations.

IMPORTANT NOTICE

Texas Instruments Incorporated and its subsidiaries (TI) reserve the right to make corrections, modifications, enhancements, improvements, and other changes to its products and services at any time and to discontinue any product or service without notice. Customers should obtain the latest relevant information before placing orders and should verify that such information is current and complete. All products are sold subject to TI's terms and conditions of sale supplied at the time of order acknowledgment.

TI warrants performance of its hardware products to the specifications applicable at the time of sale in accordance with TI's standard warranty. Testing and other quality control techniques are used to the extent TI deems necessary to support this warranty. Except where mandated by government requirements, testing of all parameters of each product is not necessarily performed.

TI assumes no liability for applications assistance or customer product design. Customers are responsible for their products and applications using TI components. To minimize the risks associated with customer products and applications, customers should provide adequate design and operating safeguards.

TI does not warrant or represent that any license, either express or implied, is granted under any TI patent right, copyright, mask work right, or other TI intellectual property right relating to any combination, machine, or process in which TI products or services are used. Information published by TI regarding third-party products or services does not constitute a license from TI to use such products or services or a warranty or endorsement thereof. Use of such information may require a license from a third party under the patents or other intellectual property of the third party, or a license from TI under the patents or other intellectual property of TI.

Reproduction of TI information in TI data books or data sheets is permissible only if reproduction is without alteration and is accompanied by all associated warranties, conditions, limitations, and notices. Reproduction of this information with alteration is an unfair and deceptive business practice. TI is not responsible or liable for such altered documentation. Information of third parties may be subject to additional restrictions.

Resale of TI products or services with statements different from or beyond the parameters stated by TI for that product or service voids all express and any implied warranties for the associated TI product or service and is an unfair and deceptive business practice. TI is not responsible or liable for any such statements.

TI products are not authorized for use in safety-critical applications (such as life support) where a failure of the TI product would reasonably be expected to cause severe personal injury or death, unless officers of the parties have executed an agreement specifically governing such use. Buyers represent that they have all necessary expertise in the safety and regulatory ramifications of their applications, and acknowledge and agree that they are solely responsible for all legal, regulatory and safety-related requirements concerning their products and any use of TI products in such safety-critical applications, notwithstanding any applications-related information or support that may be provided by TI. Further, Buyers must fully indemnify TI and its representatives against any damages arising out of the use of TI products in such safety-critical applications.

TI products are neither designed nor intended for use in military/aerospace applications or environments unless the TI products are specifically designated by TI as military-grade or "enhanced plastic." Only products designated by TI as military-grade meet military specifications. Buyers acknowledge and agree that any such use of TI products which TI has not designated as military-grade is solely at the Buyer's risk, and that they are solely responsible for compliance with all legal and regulatory requirements in connection with such use.

TI products are neither designed nor intended for use in automotive applications or environments unless the specific TI products are designated by TI as compliant with ISO/TS 16949 requirements. Buyers acknowledge and agree that, if they use any non-designated products in automotive applications, TI will not be responsible for any failure to meet such requirements.

Following are URLs where you can obtain information on other Texas Instruments products and application solutions:

Products

Audio	www.ti.com/audio
Amplifiers	amplifier.ti.com
Data Converters	dataconverter.ti.com
DLP® Products	www.dlp.com
DSP	dsp.ti.com
Clocks and Timers	www.ti.com/clocks
Interface	interface.ti.com
Logic	logic.ti.com
Power Mgmt	power.ti.com
Microcontrollers	microcontroller.ti.com
RFID	www.ti-rfid.com
OMAP Mobile Processors	www.ti.com/omap
Wireless Connectivity	www.ti.com/wirelessconnectivity

Applications

Automotive and Transportation	www.ti.com/automotive
Communications and Telecom	www.ti.com/communications
Computers and Peripherals	www.ti.com/computers
Consumer Electronics	www.ti.com/consumer-apps
Energy and Lighting	www.ti.com/energy
Industrial	www.ti.com/industrial
Medical	www.ti.com/medical
Security	www.ti.com/security
Space, Avionics and Defense	www.ti.com/space-avionics-defense
Video and Imaging	www.ti.com/video

TI E2E Community Home Page

e2e.ti.com

Mailing Address: Texas Instruments, Post Office Box 655303, Dallas, Texas 75265
Copyright © 2012, Texas Instruments Incorporated