

MLN 25/2,5 schwarz/black

Industrial Connectors:Measuring and Testing Equipment:Measuring leads:4 mm system

Product description

Description	Measuring lead, at either end 4 mm diameter plug with caged spring and 4 mm diameter socket for tower construction. Nickel-plated copper beryllium contact spring. Highly flexible, double insulated stranded lead, grip and lead shatter-proof. Built in colour indicator for easy identification of insulation damages.
Type	MLN 25/2,5 schwarz/black
Order No.	934 059-100
System	4 mm system
Cable length	25 cm
Conductor size	2,5 mm ²
Cable material	PVC
Cable color	black
Housing Color	black
Color types	●●●●●●
Other standard types	red color, order no. 934 059-101; blue color, order no. 934 059-102; yellow color, order no. 934 059-103; green color, order no. 934 059-104; yellow/green color, order no. 934 059-188

Drawing

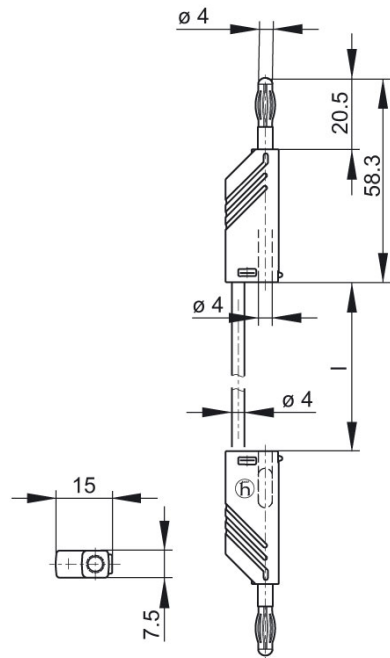

Technical data

Pin dimensions	4 mm
Type of contact	pin (spring-loaded)
Type of termination	4 mm diameter pin and socket
Cable type	LEH-XY
Cable specification	highly flexible lead
Wire stranding	320 x 0.10
Rated voltage	DC 60 V
Rated current	32 A
Contact resistance	6 mOhm

Material

Contact material	contact pin: brass, contact spring: copper beryllium
Contact surface material	nickel-plated
Housing material	PA

Environmental conditions

Temperature range	-15 °C to +70 °C
-------------------	------------------

Inflammability class

Cable	94 HB
Housing	94 V-2