

# GPS+GSM Combination Antenna **JCB012**

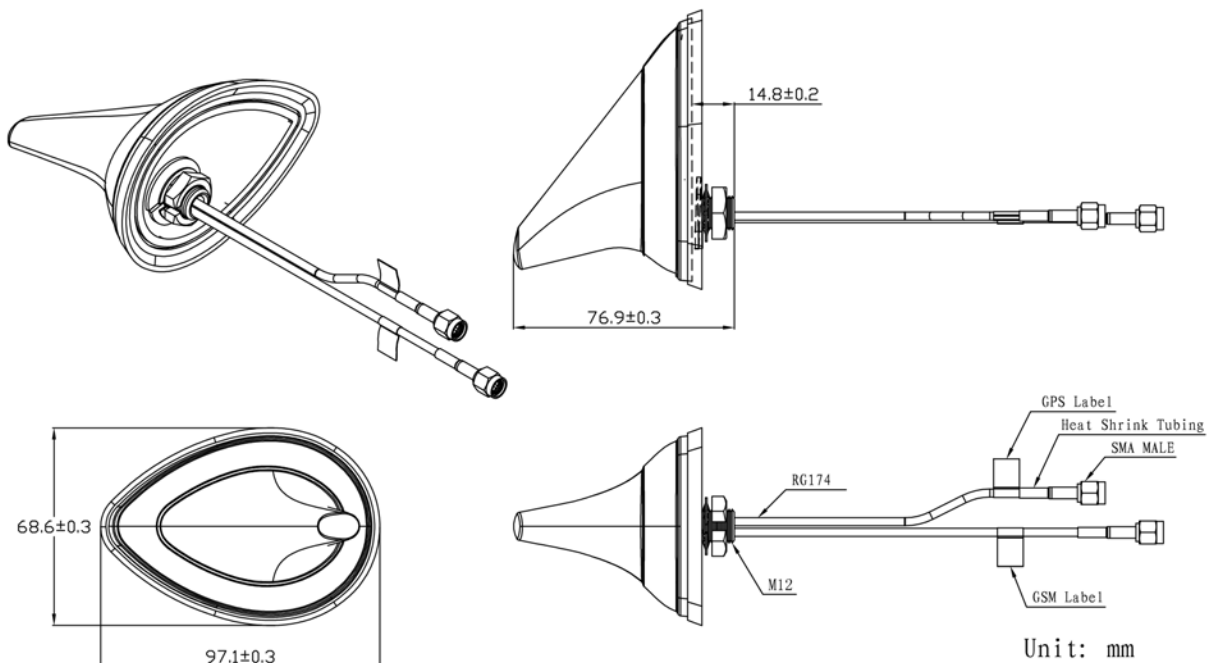

## DIMENSIONS



**JIAXING JINCHANG ELECTRONIC TECHNOLOGY CO.,LTD**

Add: 398#, Zhenye Road, South Street, Jiaxing, Zhejiang, China

Http:// [www.jinchanggps.com](http://www.jinchanggps.com)

E-mail: [jcgps@vip.163.com](mailto:jcgps@vip.163.com)

Tel: 86-0573-83692157/83692605/83958637 Fax: 86-0573-83958635

**SPECIFICATIONS**

Item		Specifications	
GPS Antenna	Dielectric Antenna	Center Frequency	1575.42±1MHz
		Band Width	CF±5MHz
		Polarization	RHCP
		Gain	5dBic (Zenith)
		V.S.W.R	<1.5
		Impedance	50Ω
		Axial Ratio	3dB (max)
	LNA	Gain	28±2dB
		Noise Figure	<1.5
		Ex-band Attenuation	12dB@CF+50MHz/16dB@CF-50MHz
		V.S.W.R	<2.0
		Supply Voltage	2.2~5V DC
	Current Consumption	5~15mA	
GSM Antenna	Frequency Range	824~960MHz/1710~2170MHz	
	V.S.W.R	<2.5	
	Polarization	Linear	
	Gain	2dBi	
	Impedance	50Ω	
Mechanical	Cable	RG174	
	Connector	SMA/MCX/FAKRA or others	
	Radome Material	ABS	
	Mounting Method	Screw	
Environmental	Operating Temperature	-40℃~+85℃	
	Relative Humidity	Up to 95%	
	Ingress Protection	IP67 (exclude cable outlet)	
	Vibration	10 to 55Hz with 1.5mm amplitude 2hours	
	Environmentally Friendly	ROHS Compliant	

**Radication Pattern**

GPS Antenna

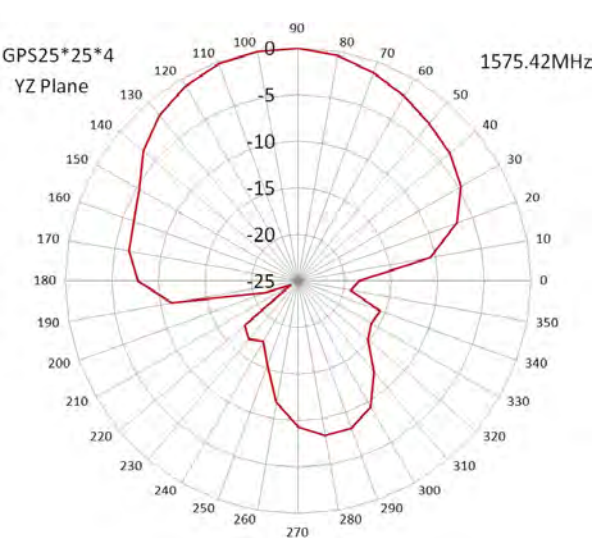
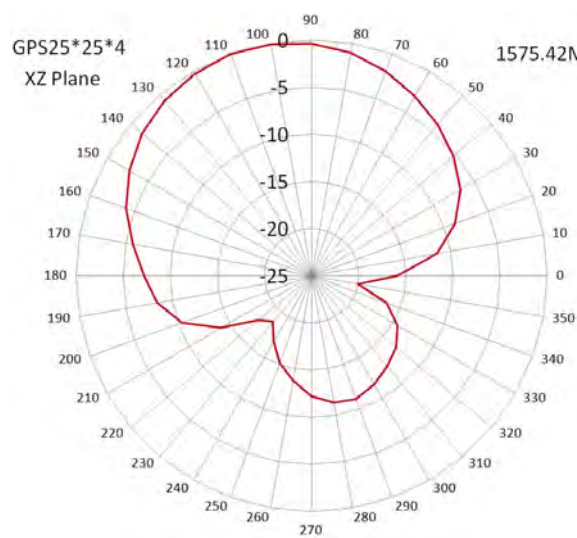
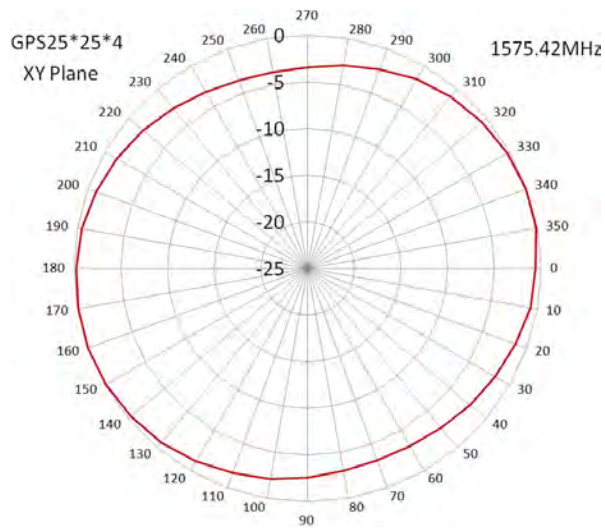

GSM Antenna

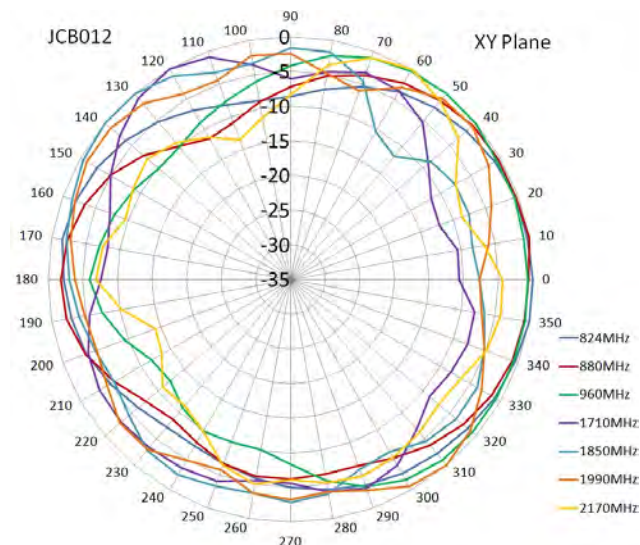

**JIAXING JINCHANG ELECTRONIC TECHNOLOGY CO.,LTD**

Add: 398#, Zhenye Road, South Street, Jiaxing, Zhejiang, China

Http:// www.jinchanggps.com

E-mail:jcgps@vip.163.com

Tel: 86-0573-83692157/83692605/83958637 Fax:86-0573-83958635



Jinchang Electron Global Service

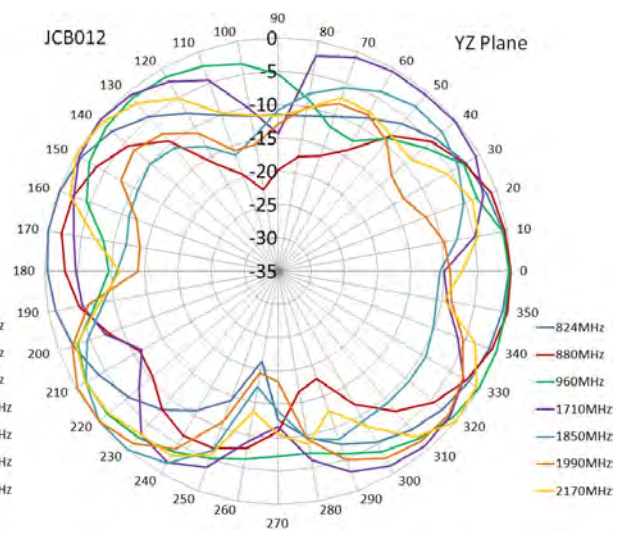
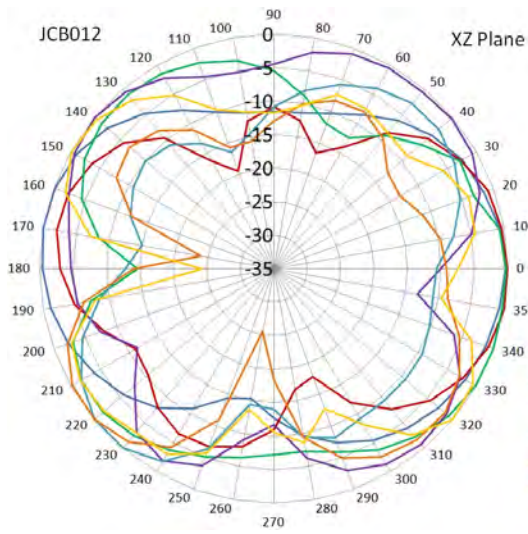

**JIAXING JINCHANG ELECTRONIC TECHNOLOGY CO.,LTD**

Add: 398#, Zhenye Road, South Street, Jiaxing, Zhejiang, China

Http:// [www.jinchanggps.com](http://www.jinchanggps.com)

E-mail: [jcgps@vip.163.com](mailto:jcgps@vip.163.com)

Tel: 86-0573-83692157/83692605/83958637 Fax: 86-0573-83958635