

GPS+GSM Combination Antenna **JCB010**

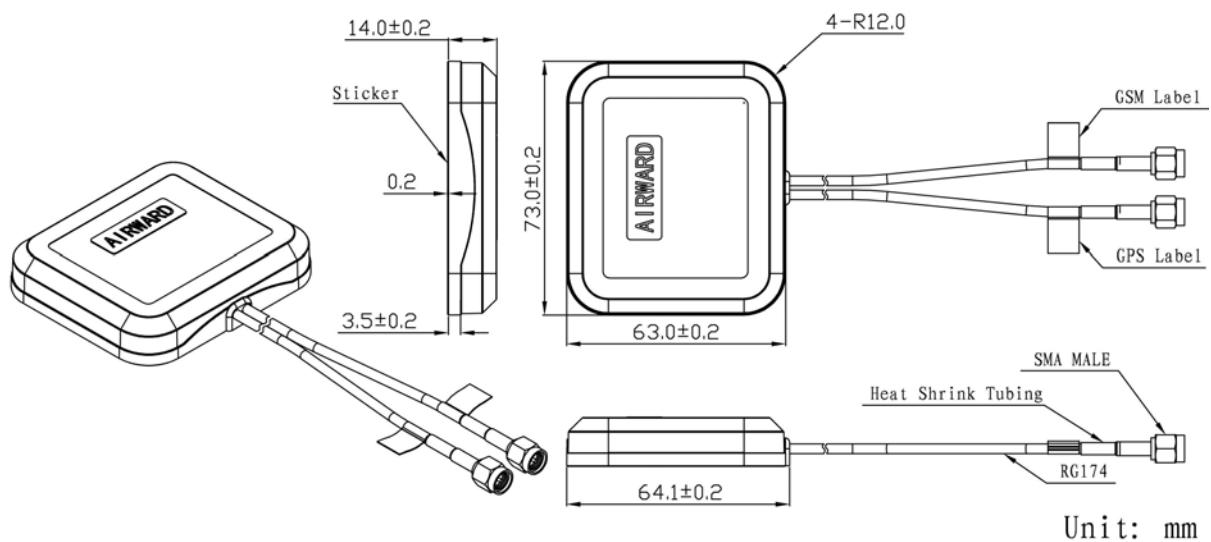

DIMENSIONS



SPECIFICATIONS

Item		Specifications	
GPS Antenna	Dielectric Antenna	Center Frequency	1575.42±1MHz
		Band Width	CF±5MHz
		Polarization	RHCP
		Gain	5dBic (Zenith)
		V.S.W.R	<1.5
		Impedance	50Ω
		Axial Ratio	3dB (max)
	LNA	Gain	28±2dB
		Noise Figure	<1.5
		Ex-band Attenuation	12dB@CF+50MHz/16dB@CF-50MHz
		V.S.W.R	<2.0
		Supply Voltage	2.2~5V DC
	Current Consumption	5~15mA	
GSM Antenna	Frequency Range	824~960MHz/1710~2170MHz	
	V.S.W.R (min)	<2.0	
	Polarization	Linear	
	Gain	2dBi	
	Impedance	50Ω	
Mechanical	Cable	RG174	
	Connector	SMA/MCX/FAKRA or others	
	Radome Material	ABS	
	Mounting Method	Magnet/Adhesive	
Environmental	Operating Temperature	-40℃~+85℃	
	Relative Humidity	Up to 95%	
	Ingress Protection	IP67	
	Vibration	10 to 55Hz with 1.5mm amplitude 2hours	
	Environmentally Friendly	ROHS Compliant	

Radication Pattern

GPS Antenna

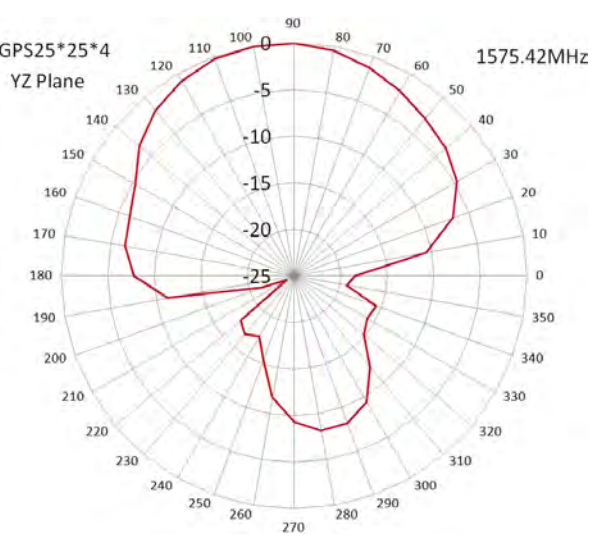
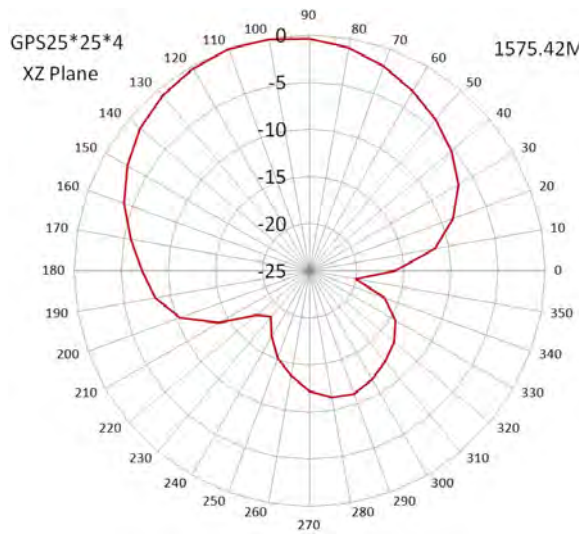
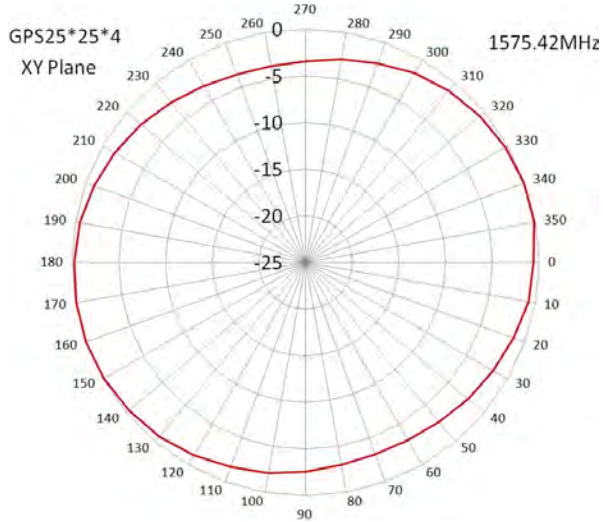

GSM Antenna

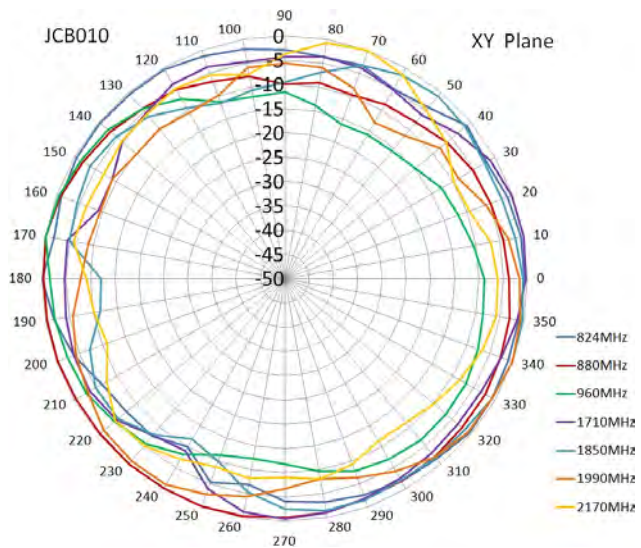



Jinchang Electron Global Service

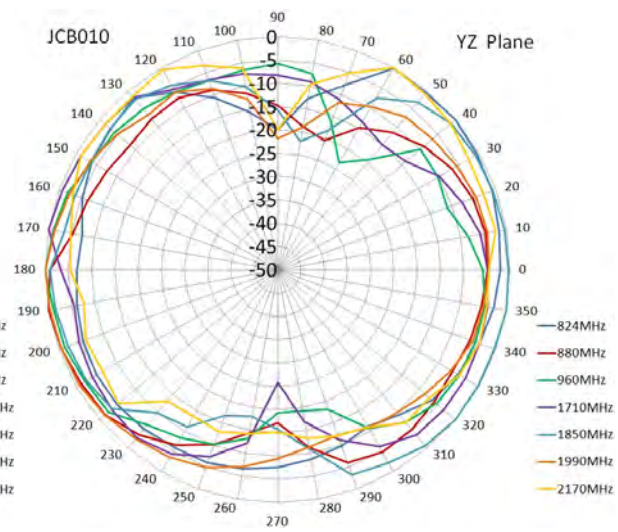
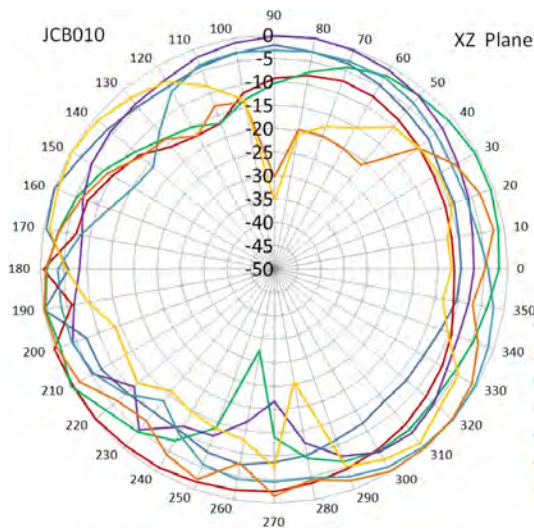

JIAXING JINCHANG ELECTRONIC TECHNOLOGY CO.,LTD

Add: 398#, Zhenye Road, South Street, Jiaxing, Zhejiang, China

Http:// www.jinchanggps.com

E-mail: jcgps@vip.163.com

Tel: 86-0573-83692157/83692605/83958637 Fax: 86-0573-83958635