

Technical Data Sheet**1.2mm round Subminiature Side Looking Infrared LED****IR26-61C/L302/TR8****Features**

- Small double-end package
- Low forward voltage
- Good spectral matching to Si photo detector
- Package in 8mm tape on 7" diameter reel.
- Pb free
- The product itself will remain within RoHS compliant version.

**Descriptions**

- IR26-61C/L302/TR8 is an infrared emitting diode in miniature SMD package which is molded in a water clear plastic with spherical top view lens. The device is spectrally matched with silicon photodiode and phototransistor

Applications

- Infrared applied system

Device Selection Guide

LED Part No.	Chip	Lens Color
	Material	
IR26-61C/L302/TR8	GaAlAs	Water Clear

Package Dimensions

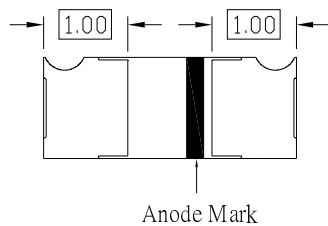
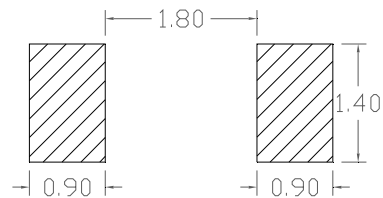
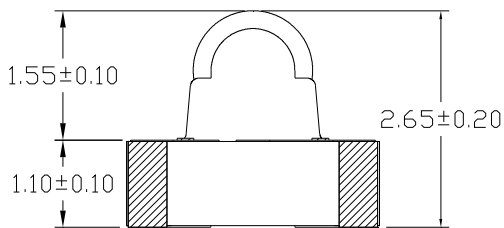
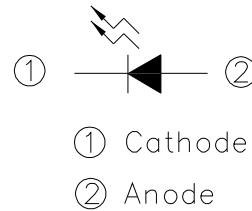
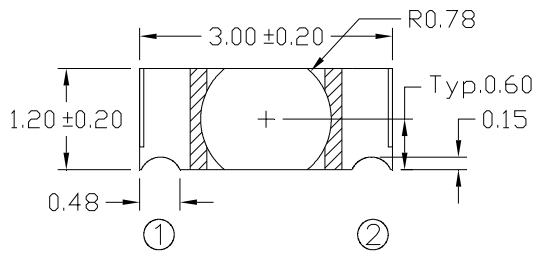

Recommended Soldering Pattern
for Side Looker

- Notes:** 1. All dimensions are in millimeters
2. Tolerances unless dimensions ± 0.1 mm

Absolute Maximum Ratings ($T_a=25^\circ\text{C}$)

Parameter	Symbol	Rating	Unit
Continuous Forward Current	I_F	65	mA
Reverse Voltage	V_R	5	V
Operating Temperature	T_{opr}	-40 ~ +85	$^\circ\text{C}$
Storage Temperature	T_{stg}	-40 ~ +100	$^\circ\text{C}$
Soldering Temperature *1	T_{sol}	260	$^\circ\text{C}$
Power Dissipation at(or below) 25 $^\circ\text{C}$ Free Air Temperature	P_d	100	mW

Notes: *1: Soldering time ≤ 5 seconds.

Electro-Optical Characteristics (Ta=25°C)

Parameter	Symbol	Condition	Min.	Typ.	Max.	Unit
Radiant Intensity	I _e	I _F =20mA	4.0	8.0	--	mW/sr
		I _F =100mA Pulse Width ≤ 100 μs, Duty ≤ 1%	--	40	--	
Peak Wavelength	λ _p	I _F =20mA	920	940	960	nm
Spectral Bandwidth	Δλ	I _F =20mA	--	30	--	nm
Forward Voltage	V _F	I _F =20mA	1.15	1.25	1.50	V
		I _F =100mA Pulse Width ≤ 100 μs, Duty ≤ 1%	1.25	1.40	180	
Reverse Current	I _R	V _R =5V	--	--	10	μA
Optical Rise Time	t _r	I _F =20mA	--	15	--	ns
Optical Fall Time	t _f	I _F =20mA	--	15	--	ns
View Angle	2θ 1/2	I _F =20mA	--	20	--	deg

I_e Rank

Condition : I_F=20mA

Unit : mW/sr

Bin Number	K	L	M	N	P
Min	4.0	5.0	6.0	7.0	8.0
Max	6.0	7.5	9.0	10.5	--

Typical Electro-Optical Characteristics Curves

Fig.1 Forward Current vs. Ambient Temperature

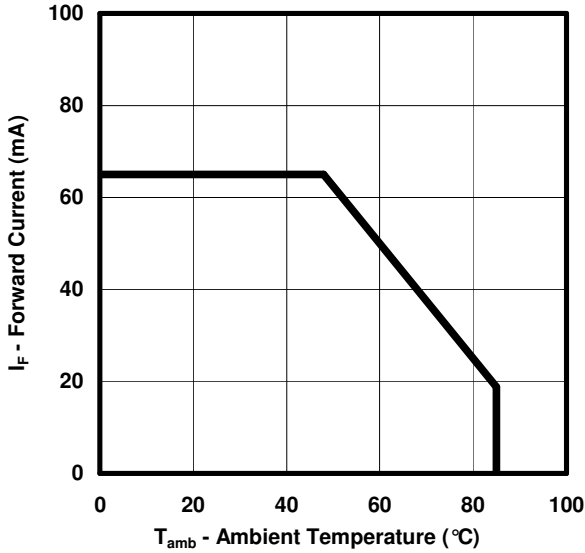

Fig.2 Spectral Distribution

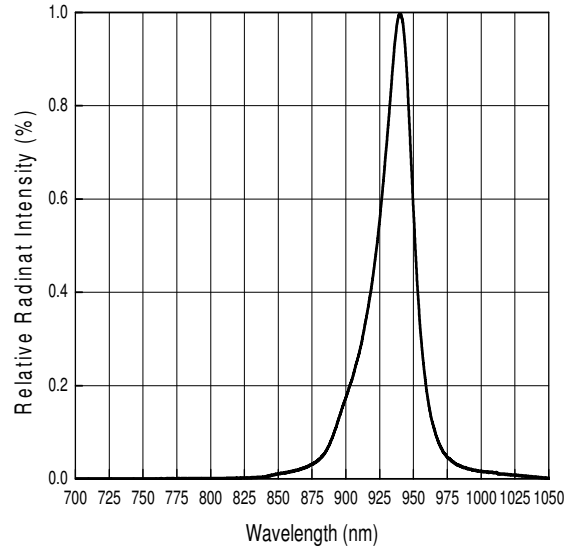

Fig.3 Relative Intensity vs. Forward Current

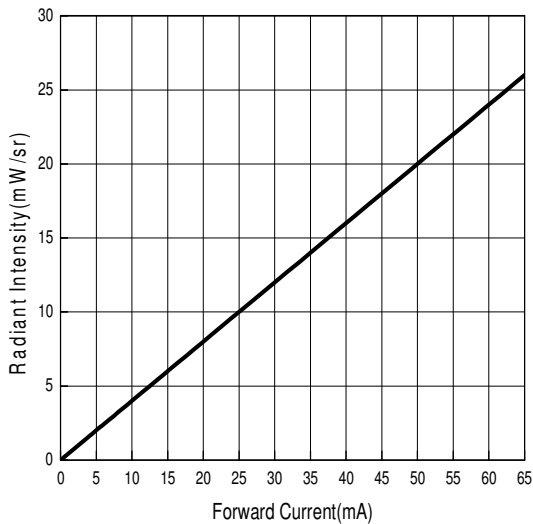
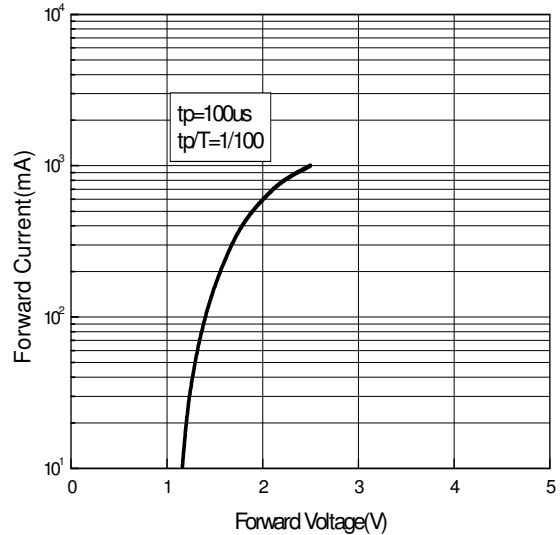
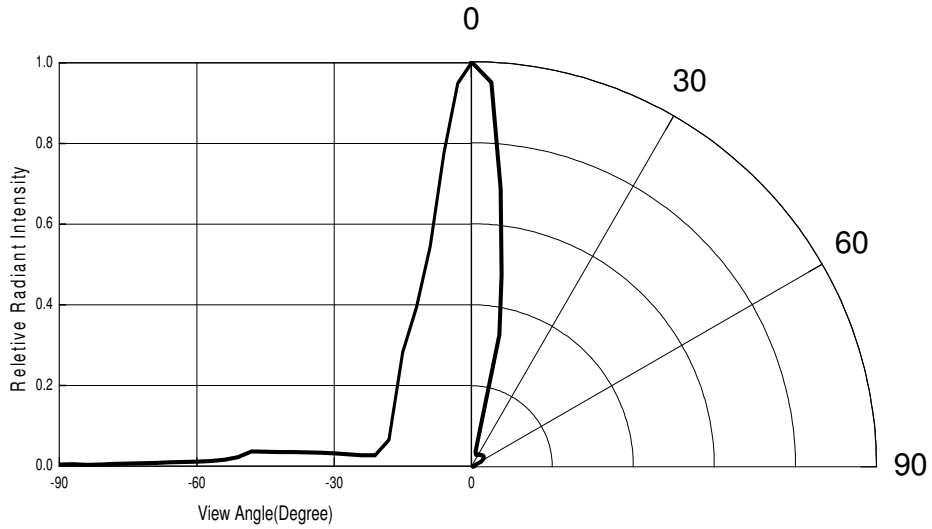

Fig.4 Forward Current vs. Forward Voltage



Typical Electro-Optical Characteristics Curves

Fig.6 Relative Radiant Intensity vs.
Angular Displacement



Precautions For Use

1. Over-current-proof

Customer must apply resistors for protection , otherwise slight voltage shift will cause big current change (Burn out will happen).

2. Storage

2.1 Do not open moisture proof bag before the products are ready to use.

2.2 Before opening the package, the LEDs should be kept at 30°C or less and 90%RH or less.

2.3 The LEDs should be used within a year.

2.4 After opening the package, the LEDs should be kept at 30°C or less and 70%RH or less.

2.5 The LEDs should be used within 168 hours (7 days) after opening the package.

2.6 If the moisture absorbent material (silica gel) has faded away or the LEDs have exceeded the storage time, baking treatment should be performed using the following conditions.

Baking treatment : 60±5°C for 24 hours.

3. Soldering Condition

3.1 Pb-free solder temperature profile

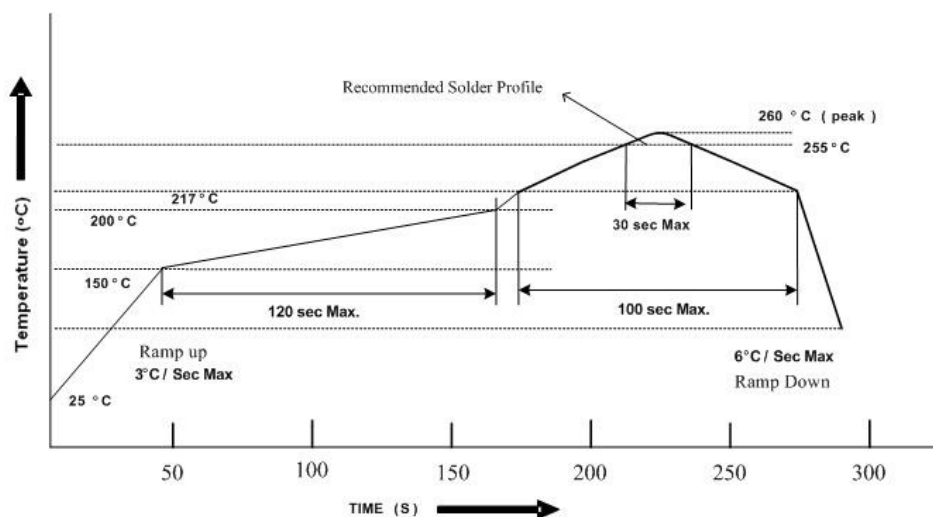

3.2 Reflow soldering should not be done more than two times.

3.3 When soldering, do not put stress on the LEDs during heating.

3.4 After soldering, do not warp the circuit board.

4.Soldering Iron

Each terminal is to go to the tip of soldering iron temperature less than 350°C for 3 seconds within once in less than the soldering iron capacity 25W. Leave two seconds and more intervals, and do soldering of each terminal. Be careful because the damage of the product is often started at the time of the hand solder.

5.Repairing

Repair should not be done after the LEDs have been soldered. When repairing is unavoidable, a double-head soldering iron should be used (as below figure). It should be confirmed beforehand whether the characteristics of the LEDs will or will not be damaged by repairing.

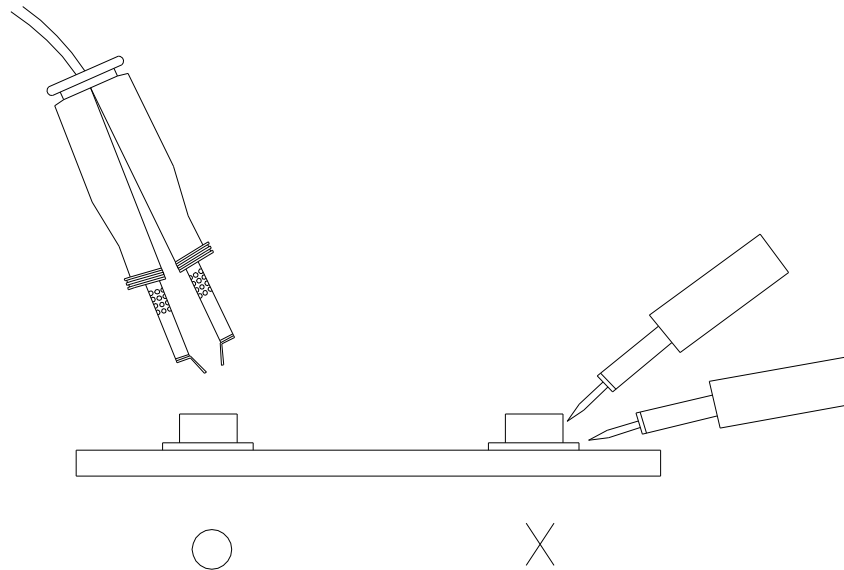

Package Dimensions

1. Reel Dimensions

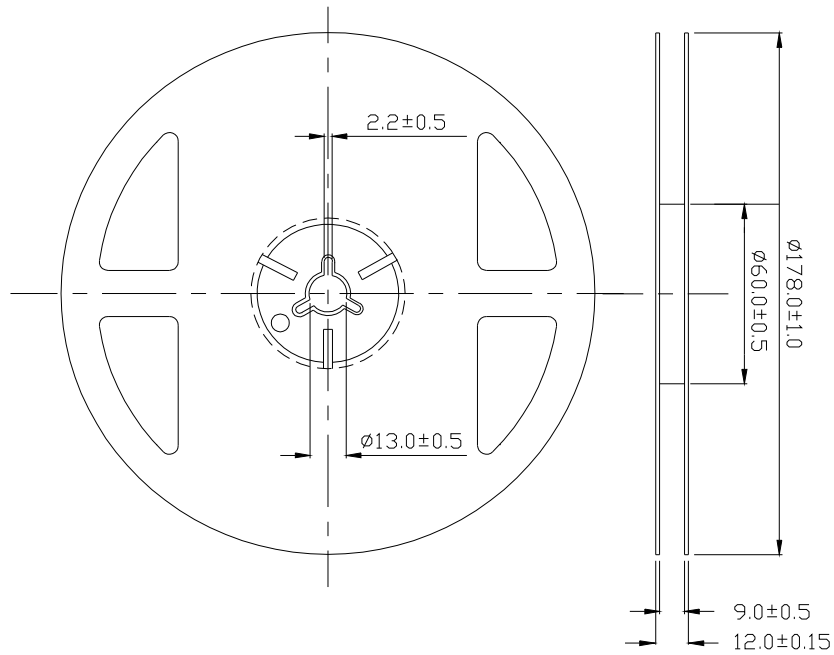

Note: The tolerances unless mentioned is ± 0.1 mm ,Unit = mm

2. Carrier Tape Dimensions:(Quantity: 1500pcs/reel)

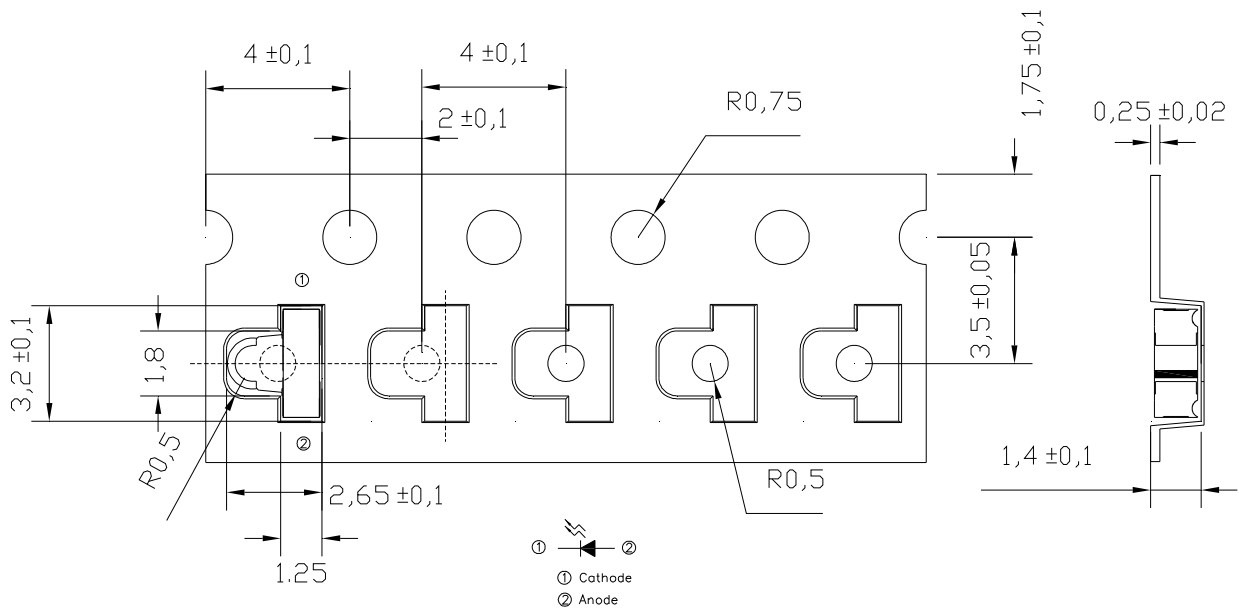

Note: The tolerances unless mentioned is ± 0.1 mm ,Unit = mm

Packing Procedure

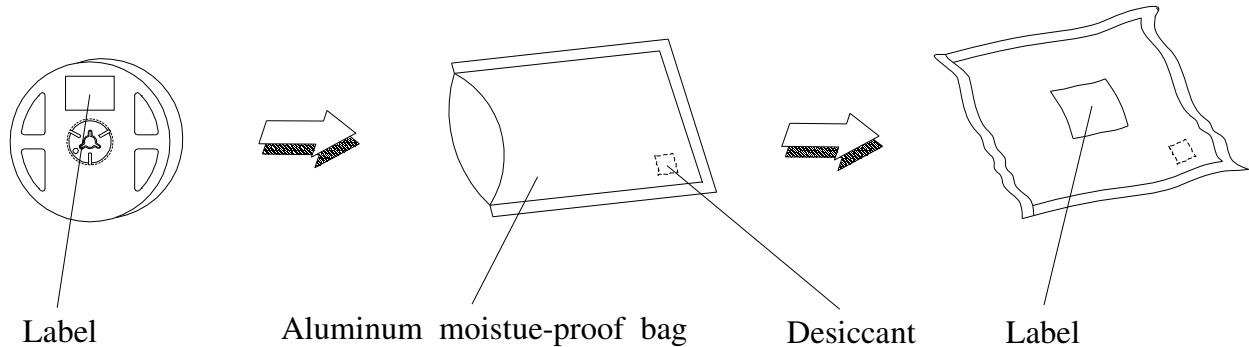

Label Form Specification



CPN: Customer's Production Number
P/N : Production Number
QTY: Packing Quantity
CAT: Ranks
HUE: Peak Wavelength
REF: Reference
LOT No: Lot Number
MADE IN TAIWAN: Production Place

Notes

1. Above specification may be changed without notice. EVERLIGHT will reserve authority on material change for above specification.
2. When using this product, please observe the absolute maximum ratings and the instructions for using outlined in these specification sheets. EVERLIGHT assumes no responsibility for any damage resulting from use of the product which does not comply with the absolute maximum ratings and the instructions included in these specification sheets.
3. These specification sheets include materials protected under copyright of EVERLIGHT corporation. Please don't reproduce or cause anyone to reproduce them without EVERLIGHT's consent.

EVERLIGHT ELECTRONICS CO., LTD.
Office: No 25, Lane 76, Sec 3, Chung Yang Rd,
Tucheng, Taipei 236, Taiwan, R.O.C

Tel: 886-2-2267-2000, 2267-9936
Fax: 886-2267-6244, 2267-6189, 2267-6306
<http://www.everlight.com>