

RoHS compliant

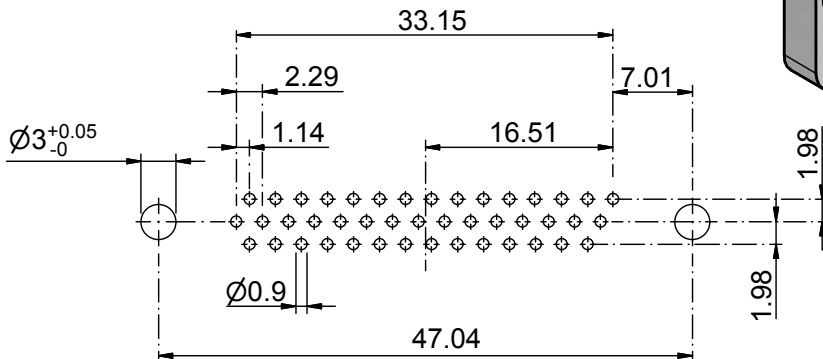
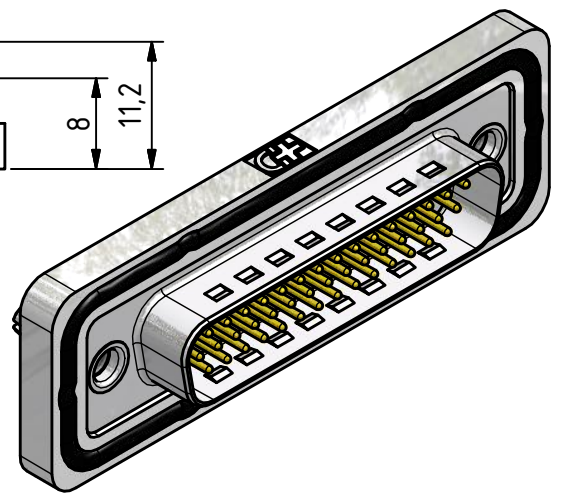
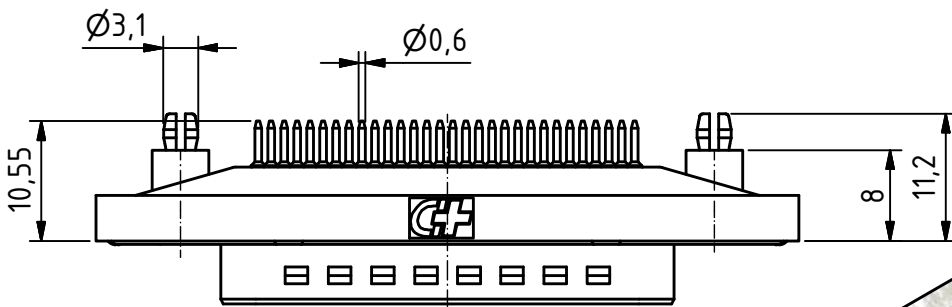
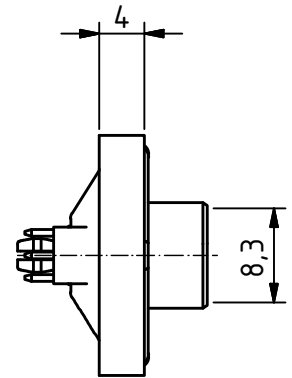
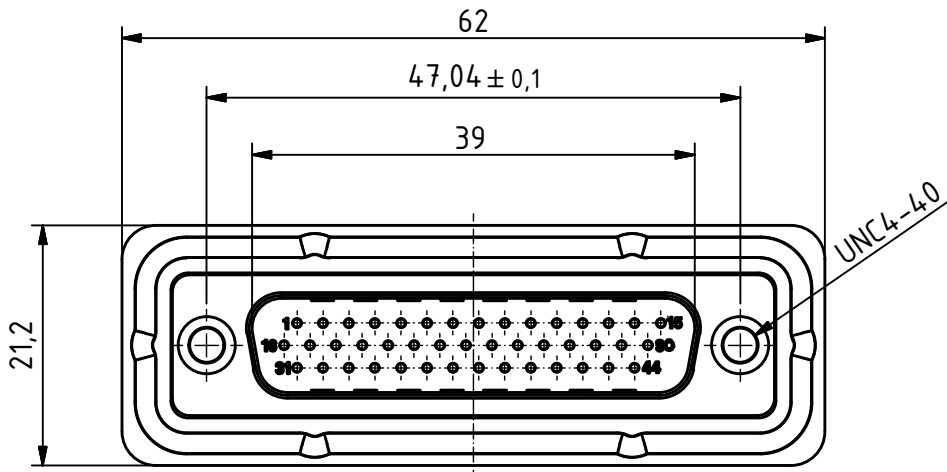

PCB Layout tolerances +/-0.1

General tolerances (Deltron standard)	
size in mm	tolerances
> 0.5	±0.1
up to 3	±0.2
> 3	±0.2
up to 6	±0.2
> 6	±0.2
up to 30	±0.2
> 30	±0.3
up to 120	±0.3

Waterproof IP68
Frame with O-ring sealing for back panel mounting

MATERIALS

- Insulator: Thermoplastic UL 94-V-0 white
- Frame: Zinc diecasting nickel plated
- Contact: Copper alloy
- Contact finish: Quality class 2
- Shell: steel tin plated

CHARAKTERISTICS

- Working voltage: 60V
- Current rating: 3A
- Contact resistance: max. 10mΩ - DIN41652
- Insulation resistance: >5GΩ
- Temperature range: -55° to +125°C

modification	Rev.	Rev.	Rev.	DE017196		
	Rev.	Rev.	Rev.	part no.		
HD-DWM44PY/2M86UN	1.5:1 scale	drawn	24.02.2016	mw		
		checked				
		approved				
 Industrie Neuhof 8c CH-3422 Kirchberg		K062447		drawing no.		