

RoHS compliant

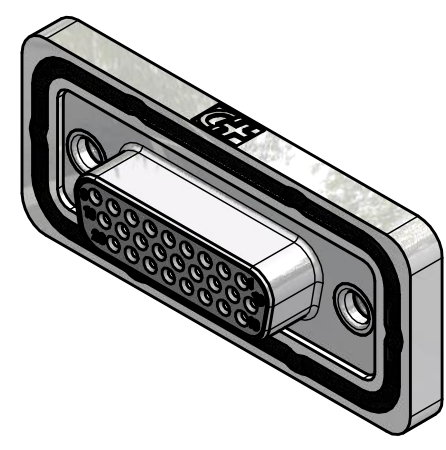
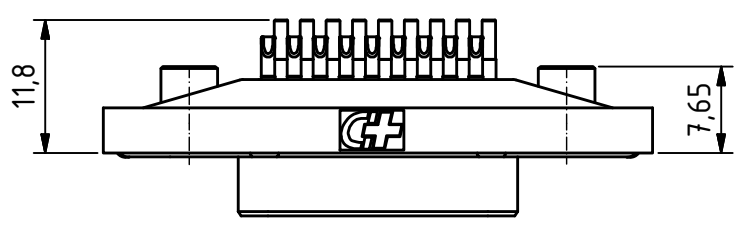
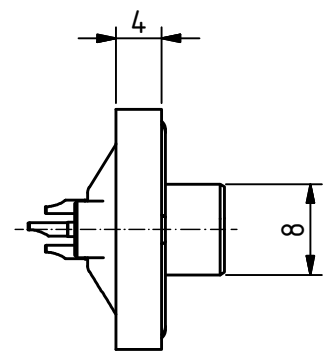
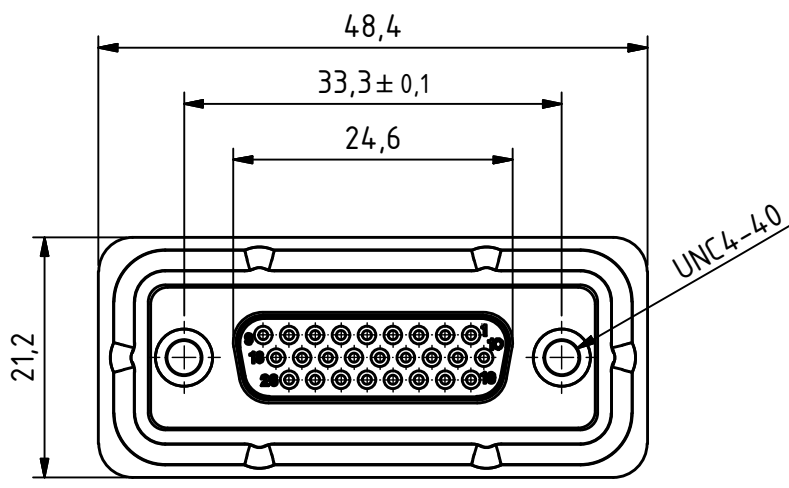

suitable for cable AWG 20

Waterproof IP68
Frame with O-ring sealing for back panel mounting

MATERIALS

- Insulator: Thermoplastic UL 94-V-0 white
- Frame: Zinc diecasting nickel plated
- Contact: Copper alloy
- Contact finish: Quality class 2
- Shell: steel tin plated

CHARAKTERISTICS

- Working voltage: 60V
- Current rating: 3A
- Contact resistance: max. 10mΩ - DIN41652
- Insulation resistance: >5GΩ
- Temperature range: -55° to +125°C

General tolerances (Deltron standard)			
size in mm	tolerances		
	> 0.5 up to 3	> 3 up to 6	> 6 up to 30
±0.1	±0.2	±0.2	±0.3

modification	Rev.	Rev.	Rev.	DE017083		
	Rev.	Rev.	Rev.	part no.		
HD-DWM26SZ/2M85UN	1.5:1 scale	drawn	19.11.2015	mw		
		checked				
		approved				
 Industrie Neuhof 8c CH-3422 Kirchberg		K062357 drawing no.				