

Monitoring Relays 1-Phase True RMS AC/DC Over and Under Voltage Types DUC01, PUC01



DUC01



PUC01

- TRMS AC/DC over+under, over+over or under+under voltage monitoring relays
- Selection of measuring range by DIP-switches
- Measuring ranges from 2 to 500 V AC/DC
- Adjustable voltage on relative scale
- Adjustable hysteresis on relative scale
- Adjustable delay function (0.1 to 30 s)
- Programmable latching or inhibit at set level
- Output: 1 or 2 x 8 A SPDT relay N.D. or N.E. selectable
- For mounting on DIN-rail in accordance with DIN/EN 50 022 (DUC01) or plug-in module (PUC01)
- 45 mm Euronorm housing (DUC01) or 36 mm plug-in module (PUC01)
- LED indication for relay, alarm and power supply ON
- Galvanically separated power supply

Product Description

DUC01 and PUC01 are precise TRMS AC/DC over+under, over+over or under+under voltage (selectable by DIP-switch) monitoring relays. The voltage levels are adjustable separately and have their own time delay. Owing to the built-in latch

function, the ON-position of the relay output can be maintained. Inhibit function can be used to avoid relay operation when not desired (maintenance, transitions). The LED's indicate the state of the alarm and the output relay.

Ordering Key **DUC 01 D B23 500V**

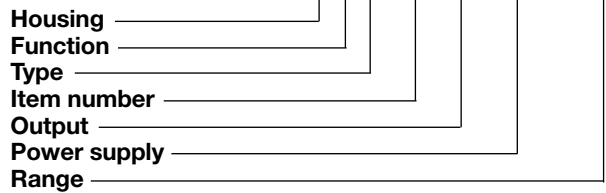

Type Selection

Mounting	Output	Supply: 24 VDC	Supply: 48 VDC	Supply: 24/48 VAC	Supply: 115/230 VAC
DIN-rail	2xSPDT	DUC 01 D 724 500V	DUC 01 D 748 500V	DUC 01 D B48 500V	DUC 01 D B23 500V
Plug-in	SPDT	PUC 01 C 724 500V	PUC 01 C 748 500V	PUC 01 C B48 500V	PUC 01 C B23 500V

Input Specifications

Input (voltage level) DUC01 PUC01	Terminals Y1, Y2 Terminals 5, 7
Measuring ranges Direct Selectable by DIP-switch 2 to 20 V AC/DC 5 to 50 V AC/DC 20 to 200 V AC/DC 50 to 500 V AC/DC	Internal resist. Max. volt. > 500 kΩ 350 V > 500 kΩ 350 V > 500 kΩ 600 V > 500 kΩ 600 V
Max. voltage for 1 s	1000 V
Note: The input voltage cannot raise over 300 VAC/DC with respect to ground (PUC01 only)	
Contact input DUC01 PUC01 Disabled Enabled Latch disable	Terminals Z1, Y1 Terminals 8, 9 > 10 kΩ < 500 Ω > 500 ms

Output Specifications

Output	2 x SPDT relays (DUC01) 1 x SPDT relays (PUC01)
Rated insulation voltage	250 VAC
Contact ratings (AgSnO ₂)	μ
Resistive loads	AC 1 8 A @ 250 VAC DC 12 5 A @ 24 VDC
Small inductive loads	AC 15 2.5 A @ 250 VAC DC 13 2.5 A @ 24 VDC
Mechanical life	≥ 30 x 10 ⁶ operations
Electrical life	≥ 10 ⁵ operations (at 8 A, 250 V, cos φ = 1)
Operating frequency	≤ 7200 operations/h
Dielectric strength	
Dielectric voltage	≥ 2 kVAC (rms)
Rated impulse withstand volt.	4 kV (1.2/50 μs)

Supply Specifications

Power supply Rated operational voltage through terminals: A1, A2 or A3, A2 (DUC01) 2, 10 or 11, 10 (PUC01) 724: B48: B23:	Overvoltage cat. III (IEC 60664, IEC 60038)	
	24 VDC \pm 20%, insulated	
	24/48 VAC \pm 15%	
	45 to 65 Hz, insulated	
	115/230 VAC \pm 15%	
	45 to 65 Hz, insulated	
Dielectric voltage Supply to input Supply to output Input to output	DC supply	AC supply
	2 kV	4 kV
	4 kV	4 kV
	4 kV	4 kV
Rated operational power AC DC	5 VA 3 W	

General Specifications

Power ON delay	1 s \pm 0.5 s or 6 s \pm 0.5 s
Reaction time Alarm ON delay Alarm OFF delay	(input signal variation from -20% to +20% or from +20% to -20% of set value) < 100 ms < 100 ms
Accuracy Temperature drift Delay ON alarm Repeatability	(15 min warm-up time) \pm 1000 ppm/ $^{\circ}$ C \pm 10% on set value \pm 50 ms \pm 0.5% on full-scale
Indication for Power supply ON Alarm ON Output relay ON	LED, green LED, red (flashing 2 Hz during delay time) 1 or 2 x LED, yellow
Environment Degree of protection Pollution degree Operating temperature Storage temperature	(EN 60529) IP 20 3 (DUC01), 2 (PUC01) -20 to 60 $^{\circ}$ C, R.H. < 95% -30 to 80 $^{\circ}$ C, R.H. < 95%
Housing Dimensions	DUC01 45 x 80 x 99.5 mm PUC01 36 x 80 x 94 mm
Weight	Approx. 250 g
Screw terminals Tightening torque	Max. 0.5 Nm acc. to IEC 60947
Approvals	UL, CSA (except 748)
CE Marking	Yes
EMC Immunity Emission	Electromagnetic Compatibility According to EN 61000-6-2 According to EN 61000-6-3

Mode of Operation

DUC01 and PUC01 monitor both AC and DC over+under, over+over or under+under voltage.

Example 1

(no contact input - under+over voltage - 2 x SPDT relays (1 x SPDT for PUC01))

DUC01: One relay operates when the voltage drops below the under voltage set point for more than the respective delay time. It releases when the voltage exceeds the set level plus the set hysteresis. The other relay operates when the voltage exceeds the over voltage set point for more than the respective delay time. It releases when the voltage drops below the set level minus hysteresis (the

hysteresis is the same for both set levels).

PUC01: The relay operates when the voltage drops below the under voltage set level for more than the respective set delay time or when it exceeds the over voltage set level for more than the respective set delay time. The relay releases when the voltage exceeds the under voltage set level plus hysteresis and it drops below the over voltage set level minus hysteresis (the hysteresis is the same for both set levels).

Example 2

(latch enabled active - under+ under voltage - 2 x SPDT relays (1 x SPDT for PUC01))

DUC01: Each relay operates

and latches when the voltage drops below the respective set level for more than the respective delay time. Provided that the voltage has exceeded the respective set level (see hysteresis), each relay releases when the contact input's connection is interrupted.

PUC01: The relay operates when the voltage drops below the higher set level for more than the respective delay time. Provided that the voltage has exceeded the respective set level plus hysteresis, the relay releases when the contact input is opened.

Example 3

(inhibit enable active - over+over voltage - DPDT relay (1 x SPDT for PUC01))

Provided that the contact input is opened, the relay operates when the voltage exceeds the lower set level for more than the respective delay time. It releases when the voltage drops below the lower set level (see hysteresis) or when the contact input's pins are connected.

Note:

When the inhibit contact is opened, if the input signal is already in alarm position, the delay time needs to elapse before relay(s) activation.

Function/Range/Level and Time Delay Setting

Adjust the input range setting the DIP switches 1 and 2 of the main black selector as shown below.

Select the desired function setting the DIP switches 3 to 6 of the black selector and 1, 2 of the small red selector as shown below.

To access the DIP switches open the grey plastic cover as shown below

Upper knob:
Setting of hysteresis on relative scale: 0 to 30% on set value.

Centre knobs:
Voltage level setting on relative scale: 10 to 110% on full scale.

Lower knobs:
Setting of delay on alarm time on absolute scale (0.1 to 30 s).

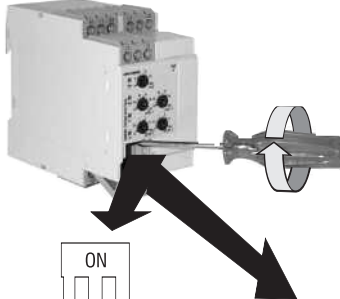

Selection of level, time delay and hysteresis:

Set Point 2 (SP2) monitoring function

ON: Over voltage
OFF: Under voltage

Relay(s) coupling

ON: 2 x SPDT (DUC01 only)
OFF: 1 x DPDT (DUC01, PUC01)

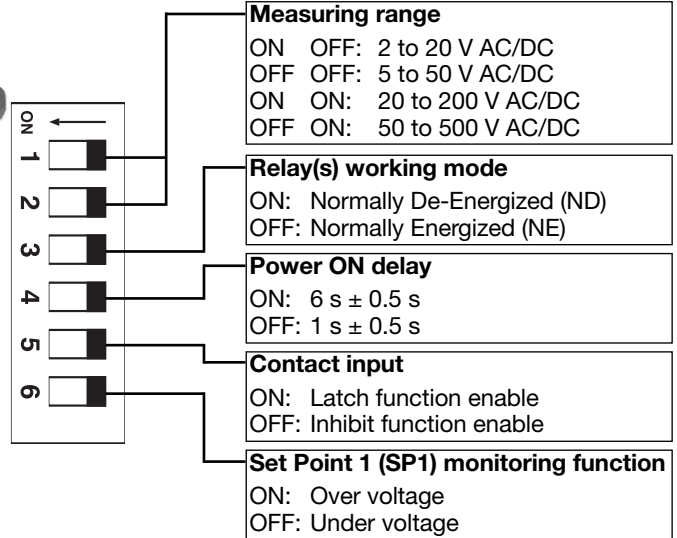
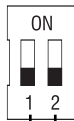

Operation Diagrams

Over+over voltage - N.D. relay(s)

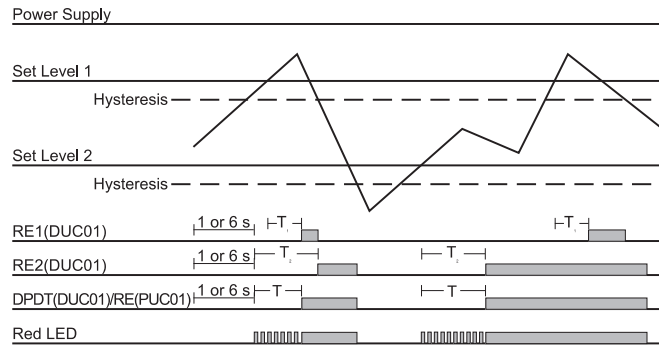

Over+over voltage - Latch - N.D. relay(s)

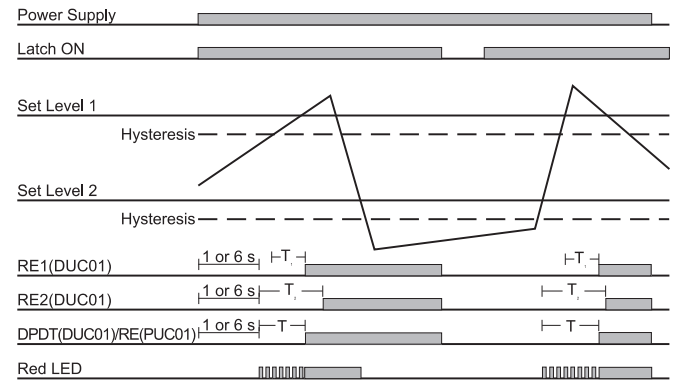

Over+under voltage - N.D. relay(s)

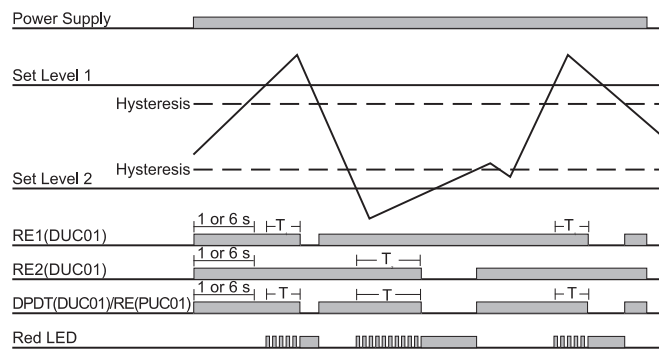

Over+under voltage - Latch - N.D. relay(s)

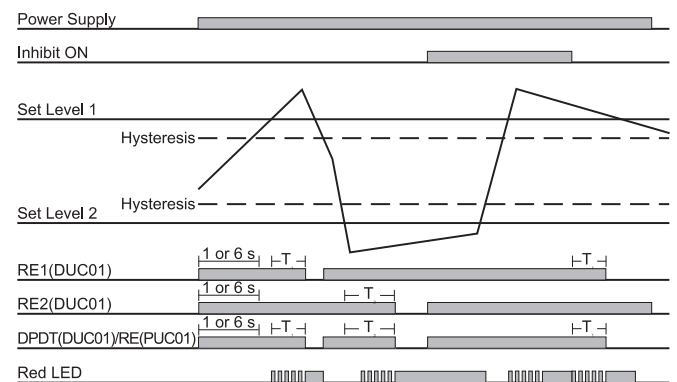

Operation Diagrams (cont.)

Under+under voltage - N.D. relay(s)

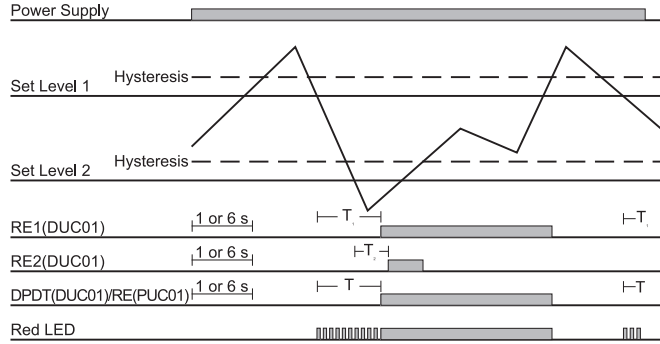

Wiring Diagrams

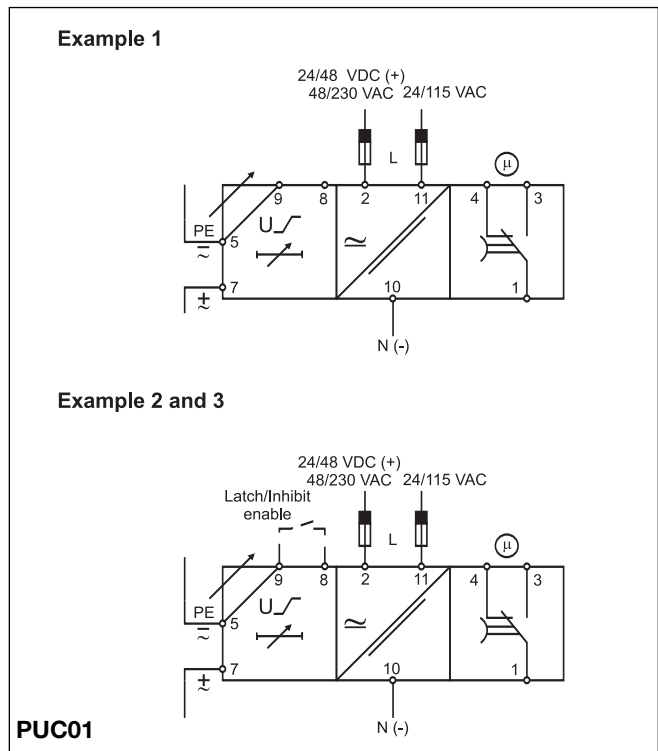
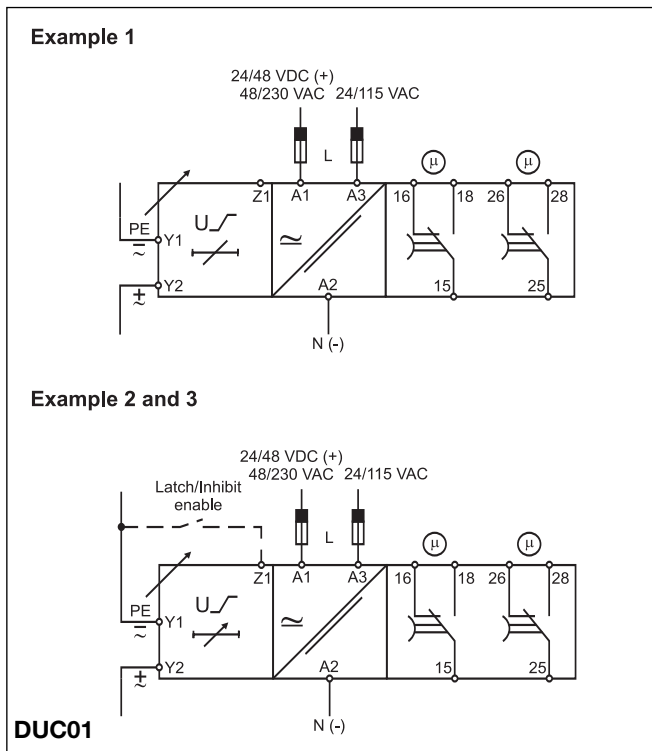

Dimensions

