

# Digital Fiber Sensor FX-300 SERIES

- FIBER SENSORS
- LASER SENSORS
- PHOTOELECTRIC SENSORS
- MICRO PHOTOELECTRIC SENSORS
- AREA SENSORS
- LIGHT CURTAINS
- PRESSURE / FLOW SENSORS
- INDUCTIVE PROXIMITY SENSORS
- PARTICULAR USE SENSORS
- SENSOR OPTIONS
- SIMPLE WIRE-SAVING UNITS
- WIRE-SAVING SYSTEMS
- MEASUREMENT SENSORS
- STATIC CONTROL DEVICES
- ENDOSCOPE
- LASER MARKERS
- PLC / TERMINALS
- HUMAN MACHINE INTERFACES
- ENERGY CONSUMPTION VISUALIZATION COMPONENTS
- FA COMPONENTS
- MACHINE VISION SYSTEMS
- UV CURING SYSTEMS

Related Information	■ General terms and conditions..... F-17	■ Sensor selection guide..... P.3~
	■ SC-GU1-485..... P.935~	■ Glossary of terms..... P.1359~
	■ General precautions ..... P.1405	■ Korea's S-mark..... P.1410

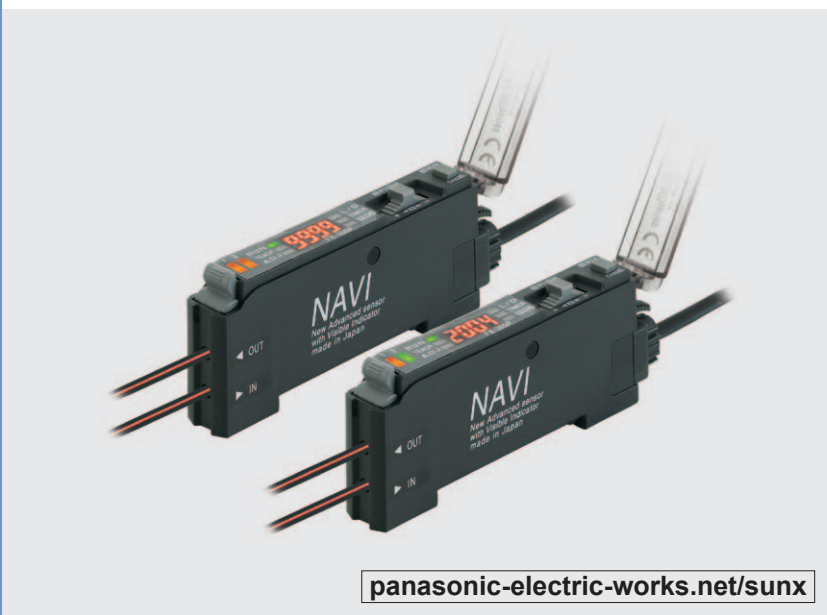

[panasonic-electric-works.net/sunx](http://panasonic-electric-works.net/sunx)

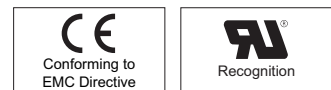

\* Passed the UL 991 Environment Test

\* UL 61010C-1 compatible, Passed the UL 991 Environment Test based on SEMI S2-0200. [Category applicable for semiconductor manufacturing: TWW2, Process Equipment] [Applicable standards: UL 61010C-1] [Additional test / evaluation standards as per intended use: UL 991, SEMI S2-0200]



## Constant advances achieving significant improvement of sensing performance

The digital fiber sensor FX-301(P) has been modified since its production in June 2004.

### Stable sensing over long and short periods FX-301 FX-301-HS FX-305

In addition to a "four-chemical emitting element" which suppresses changes in the light emitting element over time so that a stable level of light emission can be maintained over long periods, a "APC (Auto Power Control) circuit" has also been adopted afreshly. The light emitting amount can be controlled in minute degrees so that even changes occurring over very short periods can be handled, allowing stable sensing performance by suppressing deviations in light emitting amounts caused by changes in the ambient environment that could not previously be suppressed.

#### Stable sensing comparison

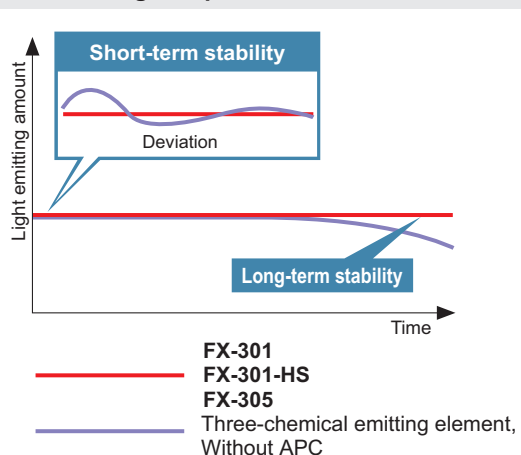

### Even greater sensing range All models

Adoption of a "double coupling lens" that increases emission efficiency to its maximum limits and greatly increases sensing range. Sensing ranges with small diameter fibers and ultra-small diameter fibers, which have become very popular due to the miniaturization of chip components, have been increased by 50 % over previous values achieved with other amplifiers.

#### Conventional fiber sensors (Without lens)

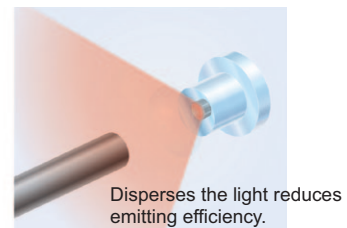

#### Double coupling lens

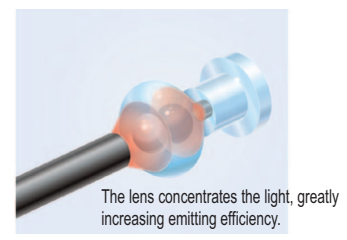

- Selection Guide
- Fibers
- Amplifiers
- FX-500
- FX-100
- FX-300
- FX-410
- FX-311
- FX-301-F7/ FX-301-F

**APPLICATIONS**

**Detecting the presence or absence of labels**

The light-emitting amount selection function can even stabilize detection of transparent labels that saturate the light-receiving level.

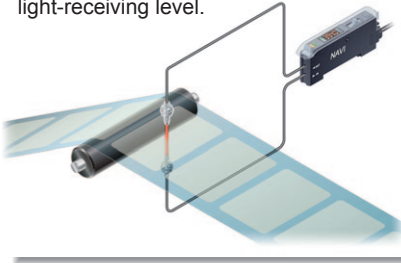

**Detecting the presence or absence of ICs on a tray**

You can set upper and lower limits for the threshold values using the window comparator mode and turn ON / OFF the incident light intensity within that limit.

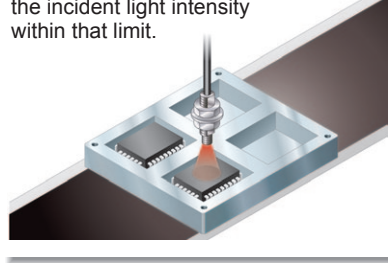

**Detecting the passage of small objects**

The differential sensing mode will only detect rapid changes in the amount of light, which makes it possible for small objects to be detected.

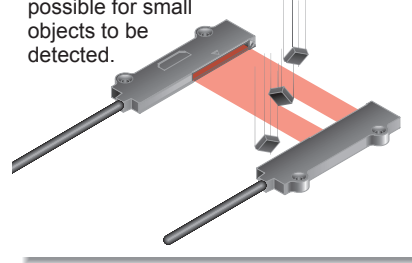

**Light-emitting amount selection**

If the light receiving level becomes saturated during close-range sensing or when sensing transparent or minute objects, you can adjust the light emitting amount of the sensor to stabilize sensing **without needing to change the response time**. Sensing that previously required the response time or fibers to be changed can now be set much more easily using this function.

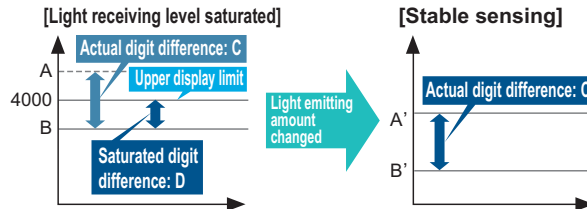

**FX-301** **FX-301-HS** **FX-305**



**Light emitting amount can be changed without changing response time**

**Large display 9999**

Large display with 4 digits (9999). With a greater difference in digit value than previous models, threshold values can be set in units of 1 digit up to maximum 9999. Threshold setting can now be done more easily and accurately.



**2.5 times previous models**

(During STDF, LONG and U-LG modes)

**FX-305**

**Ultra high-speed 35 μs response**

Ultra high-speed 35 μs response. Even small objects moving at high speeds can be sensed. In addition, at 65 μs the **FX-301** standard type and **FX-305** high-function type is also twice as fast as previous models.

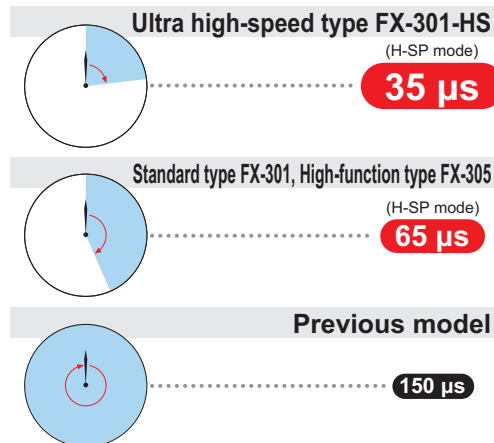
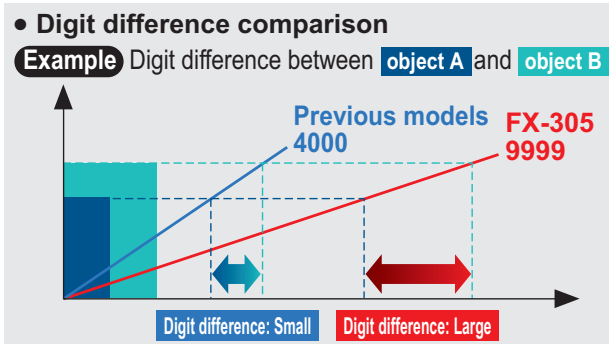
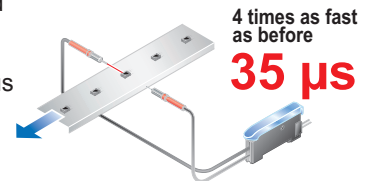

**FIBER SENSORS**

LASER SENSORS

PHOTOELECTRIC SENSORS

MICRO PHOTOELECTRIC SENSORS

AREA SENSORS

LIGHT CURTAINS

PRESSURE / FLOW SENSORS

INDUCTIVE PROXIMITY SENSORS

PARTICULAR USE SENSORS

SENSOR OPTIONS

SIMPLE WIRE-SAVING UNITS

WIRE-SAVING SYSTEMS

MEASUREMENT SENSORS

STATIC CONTROL DEVICES

ENDOSCOPE

LASER MARKERS

PLC / TERMINALS

HUMAN MACHINE INTERFACES

ENERGY CONSUMPTION VISUALIZATION COMPONENTS

FA COMPONENTS

MACHINE VISION SYSTEMS

UV CURING SYSTEMS

Selection Guide

Fibers

Amplifiers

**FX-500**

**FX-100**

**FX-300**

**FX-410**

**FX-311**

**FX-301-F7/ FX-301-F**

FIBER SENSORS

LASER SENSORS

PHOTOELECTRIC SENSORS

MICRO PHOTOELECTRIC SENSORS

AREA SENSORS

LIGHT CURTAINS

PRESSURE / FLOW SENSORS

INDUCTIVE PROXIMITY SENSORS

PARTICULAR USE SENSORS

SENSOR OPTIONS

SIMPLE WIRE-SAVING UNITS

WIRE-SAVING SYSTEMS

MEASUREMENT SENSORS

STATIC CONTROL DEVICES

ENDOSCOPE

LASER MARKERS

PLC / TERMINALS

HUMAN MACHINE INTERFACES

ENERGY CONSUMPTION VISUALIZATION COMPONENTS

FA COMPONENTS

MACHINE VISION SYSTEMS

UV CURING SYSTEMS

Selection Guide

Fibers

Amplifiers

FX-500

FX-100

FX-300

FX-410

FX-311

FX-301-F7/  
FX-301-F

**Simplified systems using new operating modes**

**FX-305**

A window comparator mode and differential sensing mode have been added. These modes make it easy to carry out sensing tasks that previously required multiple sensors or involved complex threshold settings.

• **Window comparator mode**



<Sensing ICs in trays>

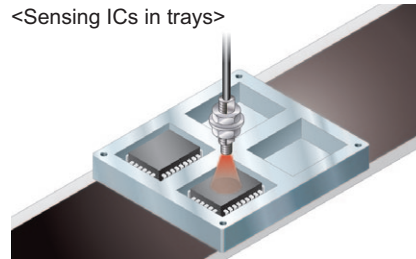

Tray absent	IC present	Tray present
OFF	ON	OFF

Upper and lower limits for threshold values can be set so that the incident light intensity can turn on and off within those ranges. Single output is used, so that only one cable is required, and no PLC processing is required either.

• **Differential sensing mode**



<Sensing of tiny moving objects>

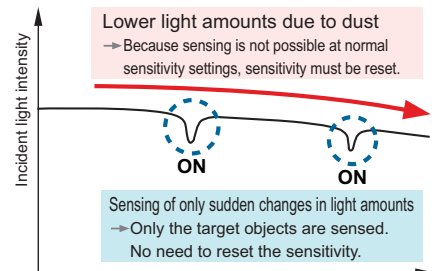
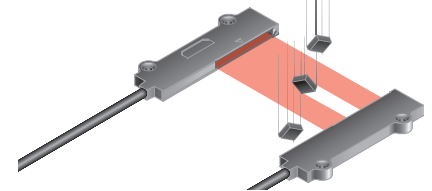

**Equipped with 5 types timers**

**FX-305**

The **FX-305** includes the same ON-delay / OFF-delay / ONE SHOT timer as the **FX-301(-HS)**, as well as an ON-delay • OFF-delay timer and an ON-delay • ONE SHOT timer. A wide variety of timer control operations can be carried out by these fiber sensors alone.

Timer period  
Output 1: 0.5 to 9,999 ms (variable)  
Output 2: 0.5 to 500 ms (variable)

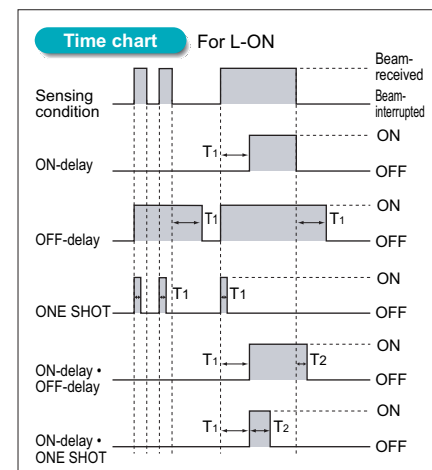

**Even beginners can quickly learn how to use the MODE NAVI**

**All models**

MODE NAVI uses six indicators to display the amplifier's basic operations. The current operating mode can be confirmed at a glance, so even a first time user can easily operate the amplifier without becoming confused.

<b>RUN</b> (Green)	<b>RUN</b> → This is the sensing mode. Incident light level is displayed in the digital display.
<b>TEACH</b> (Grey)	
<b>ADJ</b> (Grey)	
<b>RUN</b> (Grey)	<b>TEACH</b> → This mode is for setting the threshold value.
<b>TEACH</b> (Orange)	
<b>ADJ</b> (Grey)	
<b>RUN</b> (Grey)	<b>ADJ</b> → In this mode, the threshold value, once set, may be fine-tuned.
<b>TEACH</b> (Grey)	
<b>ADJ</b> (Orange)	



<b>L / D</b> (Orange)	<b>L / D ON</b> → This mode allows the selection of output operation as either Light-ON or Dark-ON.
<b>TIMER</b> (Grey)	
<b>PRO</b> (Grey)	
<b>L / D</b> (Grey)	<b>TIMER</b> → This mode permits the choice of using or not using the timer.
<b>TIMER</b> (Orange)	
<b>PRO</b> (Grey)	
<b>L / D</b> (Grey)	<b>PRO</b> → This mode allows the selection of further advanced functions, such as the copying of individual settings and the memory functions.
<b>TIMER</b> (Grey)	
<b>PRO</b> (Orange)	

**Easy confirming of threshold value settings**

**FX-301 FX-301-HS FX-305**

The threshold value can be confirmed by turning the jog switch even during RUN mode.

Jog switch is turned  
Left: **FX-301(-HS)** Right: Output 2 for **FX-305**

The threshold value is displayed

**The use of only two switches makes for very simple operations**

**All models**

Only two switches, the large jog switch and the large MODE key, are required for operation. You can operate it simply by the 3 steps shown on the right.

● **Large MODE key**



1

**MODE** Pressing the switch selects or cancels the operating mode

● **Large jog switch**

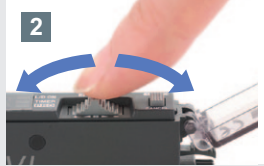

2

Moving the switch from side to side allows items to be selected



3

Pressing the switch then confirms the selected setting

**A quick-connection cable saves wiring and work-hours**

**Connector type**

**One unit can be used as either a main unit or sub unit**

The amplifier unit can be used as either a main unit or a sub unit. This feature allows for easy mounting in the side-by-side configuration. The main and sub unit functions are distinguished only by the proper use of the main cable and the sub cable. Moreover, inventory management and maintenance is simplified.

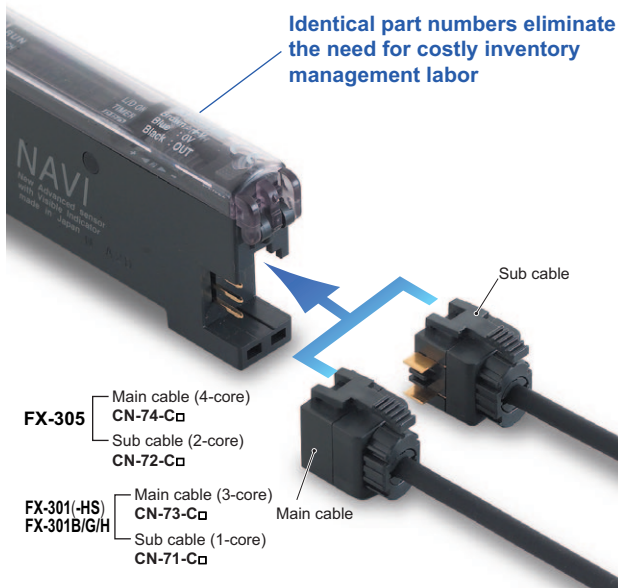

Identical part numbers eliminate the need for costly inventory management labor

- FX-305**
  - Main cable (4-core) CN-74-C□
  - Sub cable (2-core) CN-72-C□
- FX-301(-HS) / FX-301B/G/H**
  - Main cable (3-core) CN-73-C□
  - Sub cable (1-core) CN-71-C□

**An optical communication function allows up to \*16 sensors to be adjusted simultaneously**

**FX-301 | FX-305**

The optical communication function allows the data that is currently set to be copied and saved all at once for all amplifiers connected together from the right side. This greatly reduces troublesome setup tasks and makes setup much smoother. In addition, troublesome adjustment operations at times such as when replacing sensors can also be carried out easily and data can also be copied and stored using the optical communication function.



\* Use the optical communication function for only the same types of sensors. Furthermore, the FX-301-HS is not equipped with optical communication function capability.

**Settings can be entered directly using numerical input**

**All models**

Every function can be directly set merely by the input of a four digit code (numbers) from the code table. This convenient feature is easy to set up. In the event that settings are accidentally changed at the operating site, merely entering the correct code can restore the original settings. This results in easy and quick maintenance.

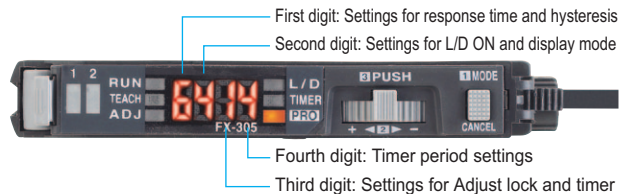

- First digit: Settings for response time and hysteresis
- Second digit: Settings for L/D ON and display mode
- Third digit: Settings for Adjust lock and timer
- Fourth digit: Timer period settings

**Communication unit improves equipment starting up and maintenance**

**FX-301 | FX-305**

**External input unit for digital sensor**

**FX-CH2**

Teaching and changing settings can be performed by using the PLC and touch panel.

Various settings and switching of up to 16 units of digital fiber sensors can be accomplished at once without operating the actual sensors themselves, but via external signals, such as the PLC, touch panel, and push buttons.

**<Main functions>**

- Batch teaching
- Key lock setting
- Batch loading / saving of the data bank



Refer to our website for details

**Upper communication unit for digital sensor**

**SC-GU1-485**

We now offer remote maintenance for digital sensors!

The communication unit enables inputs to the digital fiber sensors (such as teaching and data bank switching) to be carried out via a PLC or a personal computer, and also allows confirming of the incident light intensity an output status for the fiber sensors. This greatly improves workability during equipment starting up and maintenance.

**<Communicable commands>**

- Sensor incident light intensity
- Sensor settings verification
- Sensor output status
- Threshold value settings, etc.

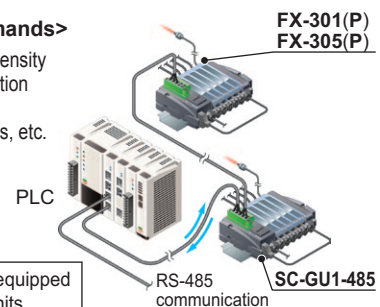

Refer to **SC-GU1-485** pages for details

**FIBER SENSORS**

LASER SENSORS

PHOTOELECTRIC SENSORS

MICRO PHOTOELECTRIC SENSORS

AREA SENSORS

LIGHT CURTAINS

PRESSURE / FLOW SENSORS

INDUCTIVE PROXIMITY SENSORS

PARTICULAR USE SENSORS

SENSOR OPTIONS

SIMPLE WIRE-SAVING UNITS

WIRE-SAVING SYSTEMS

MEASUREMENT SENSORS

STATIC CONTROL DEVICES

ENDOSCOPE

LASER MARKERS

PLC / TERMINALS

HUMAN MACHINE INTERFACES

ENERGY CONSUMPTION VISUALIZATION COMPONENTS

FA COMPONENTS

MACHINE VISION SYSTEMS

UV CURING SYSTEMS

Selection Guide

Fibers

Amplifiers

**FX-500**

**FX-100**

**FX-300**

**FX-410**

**FX-311**

**FX-301-F7/ FX-301-F**

**ORDER GUIDE**

**Amplifiers** Quick-connection cable is not supplied with the amplifier. Please order it separately.

Type	Appearance	Model No.	Emitting element	Output	Quick-connection cables				
					Type	Model No.	Length		
Standard type		<b>FX-301</b>	Red LED	NPN open-collector transistor	Main cable (3-core)	<b>CN-73-C1</b>	1 m <a href="#">3.281 ft</a>		
		<b>FX-301P</b>		PNP open-collector transistor					
		<b>FX-301B</b>	Blue LED	NPN open-collector transistor		<b>CN-73-C2</b>	2 m <a href="#">6.562 ft</a>		
		<b>FX-301BP</b>		PNP open-collector transistor					
		<b>FX-301G</b>	Green LED	NPN open-collector transistor		<b>CN-73-C5</b>	5 m <a href="#">16.404 ft</a>		
		<b>FX-301GP</b>		PNP open-collector transistor					
		<b>FX-301H</b>	Infrared LED	NPN open-collector transistor	<b>CN-71-C1</b>	1 m <a href="#">3.281 ft</a>			
		<b>FX-301HP</b>		PNP open-collector transistor					
		High-speed type		<b>FX-301-HS</b>	Red LED	NPN open-collector transistor	Sub cable (1-core)	<b>CN-71-C2</b>	2 m <a href="#">6.562 ft</a>
				<b>FX-301P-HS</b>		PNP open-collector transistor			
High-function type		<b>FX-305</b>	Red LED	NPN open-collector transistor	Main cable (4-core)	<b>CN-74-C1</b>	1 m <a href="#">3.281 ft</a>		
						<b>CN-74-C2</b>	2 m <a href="#">6.562 ft</a>		
						<b>CN-74-C5</b>	5 m <a href="#">16.404 ft</a>		
		<b>FX-305P</b>		PNP open-collector transistor	Sub cable (2-core)	<b>CN-72-C1</b>	1 m <a href="#">3.281 ft</a>		
						<b>CN-72-C2</b>	2 m <a href="#">6.562 ft</a>		
						<b>CN-72-C5</b>	5 m <a href="#">16.404 ft</a>		

## ORDER GUIDE

### Quick-connection cables

**For FX-301(-HS)/B/G/H** Quick-connection cable is not supplied with the amplifier. Please order it separately.

Type	Model No.	Length	Description
Main cable (3-core)	<b>CN-73-C1</b>	Length: 1 m <b>3.281 ft</b>	0.15 mm <sup>2</sup> 3-core cabtyre cable, with connector on one end Cable outer diameter: $\varnothing$ 3.0 mm $\varnothing$ 0.118 in
	<b>CN-73-C2</b>	Length: 2 m <b>6.562 ft</b>	
	<b>CN-73-C5</b>	Length: 5 m <b>16.404 ft</b>	
Sub cable (1-core)	<b>CN-71-C1</b>	Length: 1 m <b>3.281 ft</b>	0.15 mm <sup>2</sup> 1-core cabtyre cable, with connector on one end Cable outer diameter: $\varnothing$ 3.0 mm $\varnothing$ 0.118 in
	<b>CN-71-C2</b>	Length: 2 m <b>6.562 ft</b>	
	<b>CN-71-C5</b>	Length: 5 m <b>16.404 ft</b>	

#### Main cable

- **CN-73-C□**

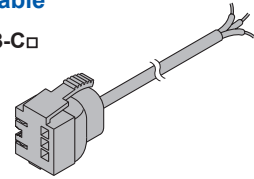

#### Sub cable

- **CN-71-C□**

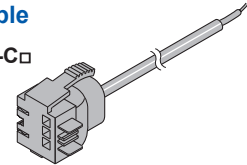

**For FX-305** Quick-connection cable is not supplied with the amplifier. Please order it separately.

Type	Model No.	Length	Description
Main cable (4-core)	<b>CN-74-C1</b>	Length: 1 m <b>3.281 ft</b>	0.15 mm <sup>2</sup> 4-core cabtyre cable, with connector on one end Cable outer diameter: $\varnothing$ 3.0 mm $\varnothing$ 0.118 in
	<b>CN-74-C2</b>	Length: 2 m <b>6.562 ft</b>	
	<b>CN-74-C5</b>	Length: 5 m <b>16.404 ft</b>	
Sub cable (2-core)	<b>CN-72-C1</b>	Length: 1 m <b>3.281 ft</b>	0.15 mm <sup>2</sup> 2-core cabtyre cable, with connector on one end Cable outer diameter: $\varnothing$ 3.0 mm $\varnothing$ 0.118 in
	<b>CN-72-C2</b>	Length: 2 m <b>6.562 ft</b>	
	<b>CN-72-C5</b>	Length: 5 m <b>16.404 ft</b>	

#### Main cable

- **CN-74-C□**

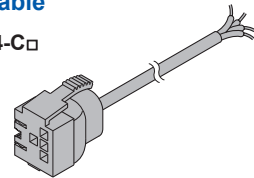

#### Sub cable

- **CN-72-C□**

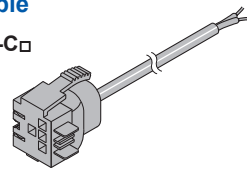

**End plates** End plates are not supplied with the amplifier. Please order them separately when the amplifiers are mounted in cascade.

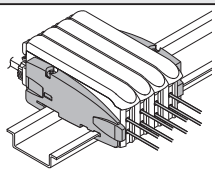
Appearance	Model No.	Description
	<b>MS-DIN-E</b>	When cascading multiple amplifiers, or when it moves depending on the way it is installed on a DIN rail, these end plates clamp amplifiers into place on both sides. Make sure to use end plates when cascading multiple amplifiers together. <b>Two pcs. per set</b>

## OPTIONS

Designation	Model No.	Description
Amplifier mounting bracket	<b>MS-DIN-2</b>	Mounting bracket for amplifier
Fiber amplifier protection seal	<b>FX-MB1</b>	10 sets of 2 communication window seals and 1 connector seal Communication window seal: It prevents malfunction due to transmission signal from another amplifier, as well as, prevents effect on another amplifier. Connector seal: It prevents contact of any metal, etc., with the pins of the quick-connection cable.

Note: Fiber amplifier protection seals are supplied with the **FX-301(P)** and **FX-305(P)**.

#### Amplifier mounting bracket

- **MS-DIN-2**

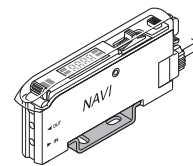

#### Fiber amplifier protection seal

- **FX-MB1**

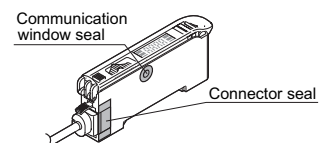

FIBER SENSORS

LASER SENSORS

PHOTO-ELECTRIC SENSORS

MICRO PHOTO-ELECTRIC SENSORS

AREA SENSORS

LIGHT CURTAINS

PRESSURE / FLOW SENSORS

INDUCTIVE PROXIMITY SENSORS

PARTICULAR USE SENSORS

SENSOR OPTIONS

SIMPLE WIRE-SAVING UNITS

WIRE-SAVING SYSTEMS

MEASUREMENT SENSORS

STATIC CONTROL DEVICES

ENDSCOPE

LASER MARKERS

PLC / TERMINALS

HUMAN MACHINE INTERFACES

ENERGY CONSUMPTION VISUALIZATION COMPONENTS

FA COMPONENTS

MACHINE VISION SYSTEMS

UV CURING SYSTEMS

Selection Guide

Fibers

Amplifiers

**FX-500**

**FX-100**

**FX-300**

**FX-410**

**FX-311**

**FX-301-F7/**  
**FX-301-F**

## LIST OF FIBERS

## FX-301 / FX-305 (Red LED type) sensing range (Note 1)

## Thru-beam type (one pair set)



The **FX-305** and **FX-301(-HS)** have different sensing modes.

**FX-305:** H-SP, FAST, STD, STDF, LONG, U-LG (no S-D mode)

**FX-301(-HS):** S-D, H-SP (Note 1), FAST, STD, LONG (no STDF or U-LG mode)

Fibers are listed in alphabetic order. Refer to p.5~ "Fiber Selection" for details of each fiber.

Model No.	Sensing range (mm in) (Note 2)							Dimensions
	Red LED							
	U-LG	LONG	STDF	STD	FAST	H-SP	S-D	
<b>FT-30</b>	450 <a href="#">17.717</a>	310 <a href="#">12.205</a>	210 <a href="#">8.268</a>	150 <a href="#">5.906</a>	110 <a href="#">4.331</a>	60 <a href="#">2.362</a>	60 <a href="#">2.362</a>	P.90
<b>FT-31</b>	440 <a href="#">17.323</a>	290 <a href="#">11.417</a>	200 <a href="#">7.874</a>	142 <a href="#">5.591</a>	105 <a href="#">4.134</a>	58 <a href="#">2.283</a>	49 <a href="#">1.929</a>	P.90
<b>FT-40</b>	1,300 <a href="#">51.181</a>	900 <a href="#">35.433</a>	600 <a href="#">23.622</a>	450 <a href="#">17.717</a>	330 <a href="#">12.992</a>	180 <a href="#">7.087</a>	180 <a href="#">7.087</a>	P.90
<b>FT-41</b>	1,000 <a href="#">39.370</a>	780 <a href="#">30.709</a>	500 <a href="#">19.685</a>	400 <a href="#">15.748</a>	280 <a href="#">11.024</a>	150 <a href="#">5.906</a>	130 <a href="#">5.118</a>	P.90
<b>FT-42</b>	1,100 <a href="#">43.307</a>	800 <a href="#">31.496</a>	550 <a href="#">21.654</a>	400 <a href="#">15.748</a>	285 <a href="#">11.220</a>	160 <a href="#">6.299</a>	150 <a href="#">5.906</a>	P.90
<b>FT-A8</b>	3,500 <a href="#">137.795</a> (Note 3)	3,500 <a href="#">137.795</a> (Note 3)	3,300 <a href="#">129.921</a>	1,500 <a href="#">59.055</a>	1,100 <a href="#">43.307</a>	1,080 <a href="#">42.520</a>	750 <a href="#">29.528</a>	P.90
<b>FT-A30</b>	3,500 <a href="#">137.795</a> (Note 3)	3,500 <a href="#">137.795</a> (Note 3)	3,500 <a href="#">137.795</a> (Note 3)	3,500 <a href="#">137.795</a> (Note 3)	3,500 <a href="#">137.795</a> (Note 3)	3,000 <a href="#">118.110</a>	3,500 <a href="#">137.795</a> (Note 3)	P.90
<b>FT-AFM2</b>	850 <a href="#">33.465</a>	650 <a href="#">25.591</a>	380 <a href="#">14.961</a>	330 <a href="#">12.992</a>	220 <a href="#">8.661</a>	100 <a href="#">3.937</a>	115 <a href="#">4.528</a>	P.90
<b>FT-AFM2E</b>	800 <a href="#">31.496</a>	590 <a href="#">23.228</a>	350 <a href="#">13.780</a>	290 <a href="#">11.417</a>	200 <a href="#">7.874</a>	90 <a href="#">3.543</a>	100 <a href="#">3.937</a>	P.90
<b>FT-B8</b>	1,600 <a href="#">62.992</a>	1,100 <a href="#">43.307</a>	700 <a href="#">27.559</a>	530 <a href="#">20.866</a>	400 <a href="#">15.748</a>	200 <a href="#">7.874</a>	180 <a href="#">7.087</a>	P.90
<b>FT-E12</b>	20 <a href="#">0.787</a>	18 <a href="#">0.709</a>	13 <a href="#">0.512</a>	10 <a href="#">0.394</a>	8 <a href="#">0.315</a>	3 <a href="#">0.118</a>	3 <a href="#">0.118</a>	P.91
<b>FT-E13</b>	20 <a href="#">0.787</a>	13 <a href="#">0.512</a>	9 <a href="#">0.354</a>	6 <a href="#">0.236</a>	5 <a href="#">0.197</a>	2 <a href="#">0.079</a>	2 <a href="#">0.079</a>	P.91
<b>FT-E22</b>	130 <a href="#">5.118</a>	80 <a href="#">3.150</a>	60 <a href="#">2.362</a>	50 <a href="#">1.969</a>	36 <a href="#">1.417</a>	18 <a href="#">0.709</a>	15 <a href="#">0.591</a>	P.91
<b>FT-E23</b>	95 <a href="#">3.740</a>	65 <a href="#">2.559</a>	42 <a href="#">1.654</a>	31 <a href="#">1.220</a>	22 <a href="#">0.866</a>	12 <a href="#">0.472</a>	12 <a href="#">0.472</a>	P.91
<b>FT-FM2</b>	1,000 <a href="#">39.370</a>	780 <a href="#">30.709</a>	500 <a href="#">19.685</a>	400 <a href="#">15.748</a>	280 <a href="#">11.024</a>	150 <a href="#">5.906</a>	130 <a href="#">5.118</a>	P.91
<b>FT-FM2S</b>	1,000 <a href="#">39.370</a>	780 <a href="#">30.709</a>	500 <a href="#">19.685</a>	400 <a href="#">15.748</a>	280 <a href="#">11.024</a>	150 <a href="#">5.906</a>	130 <a href="#">5.118</a>	P.91
<b>FT-FM2S4</b>	1,000 <a href="#">39.370</a>	780 <a href="#">30.709</a>	500 <a href="#">19.685</a>	400 <a href="#">15.748</a>	280 <a href="#">11.024</a>	150 <a href="#">5.906</a>	130 <a href="#">5.118</a>	P.91
<b>FT-FM10L</b>	19,500 <a href="#">767.717</a> (Note 4)	19,500 <a href="#">767.717</a> (Note 4)	19,500 <a href="#">767.717</a> (Note 4)	14,000 <a href="#">551.180</a>	10,000 <a href="#">393.700</a>	3,500 <a href="#">137.795</a>	3,800 <a href="#">149.606</a>	P.91
<b>FT-H13-FM2</b>	1,200 <a href="#">47.244</a>	880 <a href="#">34.646</a>	550 <a href="#">21.654</a>	440 <a href="#">17.323</a>	300 <a href="#">11.811</a>	150 <a href="#">5.906</a>	155 <a href="#">6.102</a>	P.91
<b>FT-H20-J20-S</b> (Note 5)	530 <a href="#">20.866</a>	390 <a href="#">15.354</a>	225 <a href="#">8.858</a>	200 <a href="#">7.874</a>	140 <a href="#">5.512</a>	60 <a href="#">2.362</a>	60 <a href="#">2.362</a>	P.92
<b>FT-H20-J30-S</b> (Note 5)	530 <a href="#">20.866</a>	390 <a href="#">15.354</a>	225 <a href="#">8.858</a>	200 <a href="#">7.874</a>	140 <a href="#">5.512</a>	60 <a href="#">2.362</a>	60 <a href="#">2.362</a>	P.92
<b>FT-H20-J50-S</b> (Note 5)	530 <a href="#">20.866</a>	390 <a href="#">15.354</a>	225 <a href="#">8.858</a>	200 <a href="#">7.874</a>	140 <a href="#">5.512</a>	60 <a href="#">2.362</a>	60 <a href="#">2.362</a>	P.92
<b>FT-H20-M1</b>	750 <a href="#">29.528</a>	550 <a href="#">21.654</a>	320 <a href="#">12.598</a>	280 <a href="#">11.024</a>	200 <a href="#">7.874</a>	85 <a href="#">3.346</a>	90 <a href="#">3.543</a>	P.92
<b>FT-H20-VJ50-S</b> (Note 5)	840 <a href="#">33.071</a>	550 <a href="#">21.654</a>	370 <a href="#">14.567</a>	280 <a href="#">11.024</a>	200 <a href="#">7.874</a>	90 <a href="#">3.543</a>	90 <a href="#">3.543</a>	P.92
<b>FT-H20-VJ80-S</b> (Note 5)	840 <a href="#">33.071</a>	550 <a href="#">21.654</a>	370 <a href="#">14.567</a>	280 <a href="#">11.024</a>	200 <a href="#">7.874</a>	90 <a href="#">3.543</a>	90 <a href="#">3.543</a>	P.92
<b>FT-H20W-M1</b>	420 <a href="#">16.535</a>	310 <a href="#">12.205</a>	180 <a href="#">7.087</a>	140 <a href="#">5.512</a>	100 <a href="#">3.937</a>	40 <a href="#">1.575</a>	50 <a href="#">1.969</a>	P.92
<b>FT-H30-M1V-S</b> (Note 6)	350 <a href="#">13.780</a>	250 <a href="#">9.843</a>	150 <a href="#">5.906</a>	125 <a href="#">4.921</a>	90 <a href="#">3.543</a>	50 <a href="#">1.969</a>	40 <a href="#">1.575</a>	P.92
<b>FT-H35-M2</b>	750 <a href="#">29.528</a>	550 <a href="#">21.654</a>	330 <a href="#">12.992</a>	280 <a href="#">11.024</a>	200 <a href="#">7.874</a>	85 <a href="#">3.346</a>	90 <a href="#">3.543</a>	P.92
<b>FT-H35-M2S6</b>	750 <a href="#">29.528</a>	550 <a href="#">21.654</a>	330 <a href="#">12.992</a>	280 <a href="#">11.024</a>	200 <a href="#">7.874</a>	85 <a href="#">3.346</a>	90 <a href="#">3.543</a>	P.92
<b>FT-HL80Y</b>	3,500 <a href="#">137.795</a> (Note 3)	3,500 <a href="#">137.795</a> (Note 3)	1,800 <a href="#">70.866</a>	1,350 <a href="#">53.150</a>	900 <a href="#">35.433</a>	450 <a href="#">17.717</a>	480 <a href="#">18.898</a>	P.92
<b>FT-K8</b>	3,000 <a href="#">118.110</a>	2,000 <a href="#">78.740</a>	1,500 <a href="#">59.055</a>	1,000 <a href="#">39.370</a>	800 <a href="#">31.496</a>	300 <a href="#">11.811</a>	350 <a href="#">13.780</a>	P.93
<b>FT-KV1</b>	600 <a href="#">23.622</a>	500 <a href="#">19.685</a>	300 <a href="#">11.811</a>	250 <a href="#">9.843</a>	180 <a href="#">7.087</a>	90 <a href="#">3.543</a>	100 <a href="#">3.937</a>	P.93
<b>FT-KV8</b>	3,000 <a href="#">118.110</a>	2,000 <a href="#">78.740</a>	1,500 <a href="#">59.055</a>	1,000 <a href="#">39.370</a>	800 <a href="#">31.496</a>	300 <a href="#">11.811</a>	350 <a href="#">13.780</a>	P.93
<b>FT-L80Y</b>	3,500 <a href="#">137.795</a>	3,500 <a href="#">137.795</a>	2,000 <a href="#">78.740</a>	1,500 <a href="#">59.055</a>	1,000 <a href="#">39.370</a>	500 <a href="#">19.685</a>	530 <a href="#">20.866</a>	P.93
<b>FT-NFM2</b>	400 <a href="#">15.748</a>	270 <a href="#">10.630</a>	200 <a href="#">7.874</a>	140 <a href="#">5.512</a>	100 <a href="#">3.937</a>	55 <a href="#">2.165</a>	49 <a href="#">1.929</a>	P.93
<b>FT-NFM2S</b>	400 <a href="#">15.748</a>	270 <a href="#">10.630</a>	200 <a href="#">7.874</a>	140 <a href="#">5.512</a>	100 <a href="#">3.937</a>	55 <a href="#">2.165</a>	49 <a href="#">1.929</a>	P.93
<b>FT-NFM2S4</b>	400 <a href="#">15.748</a>	270 <a href="#">10.630</a>	200 <a href="#">7.874</a>	140 <a href="#">5.512</a>	100 <a href="#">3.937</a>	55 <a href="#">2.165</a>	49 <a href="#">1.929</a>	P.93
<b>FT-P2</b>	350 <a href="#">13.780</a>	280 <a href="#">11.024</a>	160 <a href="#">6.299</a>	120 <a href="#">4.724</a>	90 <a href="#">3.543</a>	40 <a href="#">1.575</a>	42 <a href="#">1.654</a>	P.93
<b>FT-P40</b>	350 <a href="#">13.780</a>	250 <a href="#">9.843</a>	150 <a href="#">5.906</a>	100 <a href="#">3.937</a>	75 <a href="#">2.953</a>	30 <a href="#">1.181</a>	35 <a href="#">1.378</a>	P.93
<b>FT-P60</b>	550 <a href="#">21.654</a>	400 <a href="#">15.748</a>	250 <a href="#">9.843</a>	190 <a href="#">7.480</a>	140 <a href="#">5.512</a>	70 <a href="#">2.756</a>	80 <a href="#">3.150</a>	P.93

Notes: 1) Refer to p.35~ for the sensing ranges for the **FX-301-HS** in H-SP mode.

2) Note that the sensing range of the free-cut type fiber may be reduced by 20 % max. depending upon how the fiber is cut.

3) The fiber cable length practically limits the sensing range to 3,500 mm [137.795 in](#) long.

4) The fiber cable length practically limits the sensing range to 19,500 mm [767.717 in](#) long.

5) Heat-resistant joint fibers and ordinary-temperature fibers (**FT-FM2**) are sold as a set.

6) Sold as a set comprising vacuum type fiber + photo-terminal (**FV-BR1**) + fiber at atmospheric side (**FT-J8**).

**LIST OF FIBERS**

**FX-301 / FX-305 (Red LED type) sensing range (Note 1)**

**Thru-beam type (one pair set)** 

The **FX-305** and **FX-301(-HS)** have different sensing modes.  
**FX-305:** H-SP, FAST, STD, STDF, LONG, U-LG (no S-D mode)  
**FX-301(-HS):** S-D, H-SP (Note 1), FAST, STD, LONG (no STDF or U-LG mode)

Fibers are listed in alphabetic order. Refer to p.5~ "Fiber Selection" for details of each fiber.

Model No.	Sensing range (mm in) (Note 2)							Dimensions
	Red LED							
	U-LG	LONG	STDF	STD	FAST	H-SP	S-D	
<b>FT-P80</b>	900 <a href="#">35.433</a>	650 <a href="#">25.591</a>	400 <a href="#">15.748</a>	320 <a href="#">12.598</a>	230 <a href="#">9.055</a>	100 <a href="#">3.937</a>	110 <a href="#">4.331</a>	P.93
<b>FT-P81X</b>	900 <a href="#">35.433</a>	650 <a href="#">25.591</a>	380 <a href="#">14.961</a>	320 <a href="#">12.598</a>	230 <a href="#">9.055</a>	100 <a href="#">3.937</a>	110 <a href="#">4.331</a>	P.94
<b>FT-PS1</b>	100 <a href="#">3.937</a>	80 <a href="#">3.150</a>	50 <a href="#">1.969</a>	40 <a href="#">1.575</a>	30 <a href="#">1.181</a>	13 <a href="#">0.512</a>	17 <a href="#">0.669</a>	P.93
<b>FT-R80</b>	740 <a href="#">29.134</a>	530 <a href="#">20.866</a>	320 <a href="#">12.598</a>	230 <a href="#">9.055</a>	150 <a href="#">5.906</a>	75 <a href="#">2.953</a>	80 <a href="#">3.150</a>	P.94
<b>FT-S20</b>	450 <a href="#">17.717</a>	310 <a href="#">12.205</a>	210 <a href="#">8.268</a>	150 <a href="#">5.906</a>	110 <a href="#">4.331</a>	60 <a href="#">2.362</a>	60 <a href="#">2.362</a>	P.94
<b>FT-S21</b>	440 <a href="#">17.323</a>	290 <a href="#">11.417</a>	200 <a href="#">7.874</a>	142 <a href="#">5.591</a>	105 <a href="#">4.134</a>	58 <a href="#">2.283</a>	49 <a href="#">1.929</a>	P.94
<b>FT-S30</b>	1,300 <a href="#">51.181</a>	900 <a href="#">35.433</a>	600 <a href="#">23.622</a>	450 <a href="#">17.717</a>	330 <a href="#">12.992</a>	180 <a href="#">7.087</a>	180 <a href="#">7.087</a>	P.94
<b>FT-SFM2</b>	1,000 <a href="#">39.370</a>	780 <a href="#">30.709</a>	500 <a href="#">19.685</a>	400 <a href="#">15.748</a>	280 <a href="#">11.024</a>	150 <a href="#">5.906</a>	130 <a href="#">5.118</a>	P.94
<b>FT-SFM2L</b>	2,000 <a href="#">78.740</a>	1,600 <a href="#">62.992</a>	820 <a href="#">32.283</a>	800 <a href="#">31.496</a>	580 <a href="#">22.835</a>	170 <a href="#">6.693</a>	280 <a href="#">11.024</a>	P.94
<b>FT-SFM2SV2</b>	550 <a href="#">21.654</a>	400 <a href="#">15.748</a>	240 <a href="#">9.449</a>	200 <a href="#">7.874</a>	140 <a href="#">5.512</a>	65 <a href="#">2.559</a>	70 <a href="#">2.756</a>	P.94
<b>FT-SNFM2</b>	400 <a href="#">15.748</a>	270 <a href="#">10.630</a>	200 <a href="#">7.874</a>	140 <a href="#">5.512</a>	100 <a href="#">3.937</a>	55 <a href="#">2.165</a>	49 <a href="#">1.929</a>	P.95
<b>FT-T80</b>	1,000 <a href="#">39.370</a>	780 <a href="#">30.709</a>	500 <a href="#">19.685</a>	400 <a href="#">15.748</a>	280 <a href="#">11.024</a>	150 <a href="#">5.906</a>	130 <a href="#">5.118</a>	P.95
<b>FT-V10</b>	2,350 <a href="#">92.520</a>	2,000 <a href="#">78.740</a>	1,400 <a href="#">55.118</a>	1,000 <a href="#">39.370</a>	800 <a href="#">31.496</a>	340 <a href="#">13.386</a>	350 <a href="#">13.780</a>	P.95
<b>FT-V22</b>	410 <a href="#">16.142</a>	390 <a href="#">15.354</a>	220 <a href="#">8.661</a>	180 <a href="#">7.087</a>	125 <a href="#">4.921</a>	60 <a href="#">2.362</a>	63 <a href="#">2.480</a>	P.95
<b>FT-V41</b>	220 <a href="#">8.661</a>	175 <a href="#">6.890</a>	100 <a href="#">3.937</a>	80 <a href="#">3.150</a>	60 <a href="#">2.362</a>	25 <a href="#">0.984</a>	27 <a href="#">1.063</a>	P.95
<b>FT-V80Y</b>	1,000 <a href="#">39.370</a>	800 <a href="#">31.496</a>	500 <a href="#">19.685</a>	400 <a href="#">15.748</a>	280 <a href="#">11.024</a>	120 <a href="#">4.724</a>	140 <a href="#">5.512</a>	P.95
<b>FT-W4</b>	220 <a href="#">8.661</a>	160 <a href="#">6.299</a>	100 <a href="#">3.937</a>	80 <a href="#">3.150</a>	55 <a href="#">2.165</a>	25 <a href="#">0.984</a>	28 <a href="#">1.102</a>	P.95
<b>FT-W8</b>	750 <a href="#">29.528</a>	570 <a href="#">22.441</a>	350 <a href="#">13.780</a>	290 <a href="#">11.417</a>	200 <a href="#">7.874</a>	90 <a href="#">3.543</a>	100 <a href="#">3.937</a>	P.95
<b>FT-WA8</b>	3,500 <a href="#">137.795</a> (Note 3)	3,500 <a href="#">137.795</a> (Note 3)	3,300 <a href="#">129.921</a>	1,500 <a href="#">59.055</a>	1,100 <a href="#">43.307</a>	1,080 <a href="#">42.520</a>	750 <a href="#">29.528</a>	P.95
<b>FT-WA30</b>	3,500 <a href="#">137.795</a> (Note 3)	3,500 <a href="#">137.795</a> (Note 3)	3,500 <a href="#">137.795</a> (Note 3)	3,500 <a href="#">137.795</a> (Note 3)	3,500 <a href="#">137.795</a> (Note 3)	3,000 <a href="#">118.110</a>	3,500 <a href="#">137.795</a> (Note 3)	P.95
<b>FT-WKV8</b>	2,200 <a href="#">86.614</a>	1,700 <a href="#">66.929</a>	1,000 <a href="#">39.370</a>	700 <a href="#">27.559</a>	600 <a href="#">23.622</a>	280 <a href="#">11.024</a>	300 <a href="#">11.811</a>	P.96
<b>FT-WR80</b>	750 <a href="#">29.528</a>	570 <a href="#">22.441</a>	350 <a href="#">13.780</a>	290 <a href="#">11.417</a>	200 <a href="#">7.874</a>	90 <a href="#">3.543</a>	100 <a href="#">3.937</a>	P.96
<b>FT-WR80L</b>	1,500 <a href="#">59.055</a>	1,200 <a href="#">47.244</a>	750 <a href="#">29.528</a>	600 <a href="#">23.622</a>	420 <a href="#">16.535</a>	200 <a href="#">7.874</a>	210 <a href="#">8.268</a>	P.96
<b>FT-WS3</b>	780 <a href="#">30.709</a>	570 <a href="#">22.441</a>	340 <a href="#">13.386</a>	290 <a href="#">11.417</a>	200 <a href="#">7.874</a>	90 <a href="#">3.543</a>	100 <a href="#">3.937</a>	P.96
<b>FT-WS4</b>	220 <a href="#">8.661</a>	160 <a href="#">6.299</a>	100 <a href="#">3.937</a>	80 <a href="#">3.150</a>	55 <a href="#">2.165</a>	25 <a href="#">0.984</a>	28 <a href="#">1.102</a>	P.96
<b>FT-WS8</b>	750 <a href="#">29.528</a>	570 <a href="#">22.441</a>	350 <a href="#">13.780</a>	290 <a href="#">11.417</a>	200 <a href="#">7.874</a>	90 <a href="#">3.543</a>	100 <a href="#">3.937</a>	P.96
<b>FT-WS8L</b>	1,500 <a href="#">59.055</a>	1,200 <a href="#">47.244</a>	750 <a href="#">29.528</a>	600 <a href="#">23.622</a>	420 <a href="#">16.535</a>	200 <a href="#">7.874</a>	210 <a href="#">8.268</a>	P.96
<b>FT-WV42</b>	120 <a href="#">4.724</a>	90 <a href="#">3.543</a>	55 <a href="#">2.165</a>	40 <a href="#">1.575</a>	30 <a href="#">1.181</a>	13 <a href="#">0.512</a>	15 <a href="#">0.591</a>	P.96
<b>FT-WZ4</b>	300 <a href="#">11.811</a>	200 <a href="#">7.874</a>	140 <a href="#">5.512</a>	100 <a href="#">3.937</a>	70 <a href="#">2.756</a>	40 <a href="#">1.575</a>	40 <a href="#">1.575</a>	P.96
<b>FT-WZ4HB</b>	220 <a href="#">8.661</a>	150 <a href="#">5.906</a>	105 <a href="#">4.134</a>	75 <a href="#">2.953</a>	50 <a href="#">1.969</a>	30 <a href="#">1.181</a>	30 <a href="#">1.181</a>	P.97
<b>FT-WZ7</b>	660 <a href="#">25.984</a>	440 <a href="#">17.323</a>	308 <a href="#">12.126</a>	220 <a href="#">8.661</a>	150 <a href="#">5.906</a>	80 <a href="#">3.150</a>	80 <a href="#">3.150</a>	P.97
<b>FT-WZ7HB</b>	870 <a href="#">34.252</a>	580 <a href="#">22.835</a>	406 <a href="#">15.984</a>	290 <a href="#">11.417</a>	210 <a href="#">8.268</a>	110 <a href="#">4.331</a>	110 <a href="#">4.331</a>	P.97
<b>FT-WZ8</b>	950 <a href="#">37.402</a>	700 <a href="#">27.559</a>	420 <a href="#">16.535</a>	330 <a href="#">12.992</a>	240 <a href="#">9.449</a>	100 <a href="#">3.937</a>	120 <a href="#">4.724</a>	P.97
<b>FT-WZ8E</b>	2,100 <a href="#">82.677</a>	1,500 <a href="#">59.055</a>	950 <a href="#">37.402</a>	700 <a href="#">27.559</a>	500 <a href="#">19.685</a>	200 <a href="#">7.874</a>	210 <a href="#">8.268</a>	P.97
<b>FT-WZ8H</b>	3,500 <a href="#">137.795</a>	2,500 <a href="#">98.425</a>	1,600 <a href="#">62.992</a>	1,200 <a href="#">47.244</a>	850 <a href="#">33.465</a>	400 <a href="#">15.748</a>	410 <a href="#">16.142</a>	P.97
<b>FT-Z8</b>	1,100 <a href="#">43.307</a>	800 <a href="#">31.496</a>	500 <a href="#">19.685</a>	400 <a href="#">15.748</a>	300 <a href="#">11.811</a>	120 <a href="#">4.724</a>	140 <a href="#">5.512</a>	P.97
<b>FT-Z8E</b>	1,850 <a href="#">72.835</a>	1,600 <a href="#">62.992</a>	950 <a href="#">37.402</a>	800 <a href="#">31.496</a>	600 <a href="#">23.622</a>	250 <a href="#">9.843</a>	280 <a href="#">11.024</a>	P.97
<b>FT-Z8H</b>	3,100 <a href="#">122.047</a>	2,700 <a href="#">106.299</a>	1,550 <a href="#">61.024</a>	1,400 <a href="#">55.118</a>	1,000 <a href="#">39.370</a>	420 <a href="#">16.535</a>	490 <a href="#">19.291</a>	P.97
<b>FT-Z802Y</b>	3,500 <a href="#">137.795</a>	3,500 <a href="#">137.795</a>	3,000 <a href="#">118.110</a>	1,500 <a href="#">59.055</a>	1,000 <a href="#">39.370</a>	500 <a href="#">19.685</a>	530 <a href="#">20.866</a>	P.97

Notes: 1) Refer to p.35~ for the sensing ranges for the **FX-301(-HS)** in H-SP mode.  
 2) Note that the sensing range of the free-cut type fiber may be reduced by 20 % max. depending upon how the fiber is cut.  
 3) The fiber cable length practically limits the sensing range to 3,500 mm [137.795 in](#) long.

FIBER SENSORS

LASER SENSORS

PHOTO-ELECTRIC SENSORS

MICRO PHOTO-ELECTRIC SENSORS

AREA SENSORS

LIGHT CURTAINS

PRESSURE / FLOW SENSORS

INDUCTIVE PROXIMITY SENSORS

PARTICULAR USE SENSORS

SENSOR OPTIONS

SIMPLE WIRE-SAVING UNITS

WIRE-SAVING SYSTEMS

MEASUREMENT SENSORS

STATIC CONTROL DEVICES

ENDOSCOPE

LASER MARKERS

PLC / TERMINALS

HUMAN MACHINE INTERFACES

ENERGY CONSUMPTION VISUALIZATION COMPONENTS

FA COMPONENTS

MACHINE VISION SYSTEMS

UV CURING SYSTEMS

Selection Guide

Fibers

Amplifiers

**FX-500**

**FX-100**

**FX-300**

**FX-410**

**FX-311**

**FX-301-F7/ FX-301-F**



**LIST OF FIBERS**

FIBER SENSORS

LASER SENSORS

PHOTO-ELECTRIC SENSORS

MICRO PHOTO-ELECTRIC SENSORS

AREA SENSORS

LIGHT CURTAINS

PRESSURE / FLOW SENSORS

INDUCTIVE PROXIMITY SENSORS

PARTICULAR USE SENSORS

SENSOR OPTIONS

SMALL WIRE-SAVING UNITS

WIRE-SAVING SYSTEMS

MEASUREMENT SENSORS

STATIC CONTROL DEVICES

ENDOSCOPE

LASER MARKERS

PLC/ TERMINALS

HUMAN MACHINE INTERFACES

ENERGY CONSUMPTION VISUALIZATION COMPONENTS

FA COMPONENTS

MACHINE VISION SYSTEMS

UV CURING SYSTEMS

Selection Guide

Fibers

Amplifiers

FX-500

FX-100

FX-300

FX-410

FX-311

FX-301-F7/ FX-301-F

**FX-301 / FX-305 (Red LED type) sensing range (Note 1)**

**Retroreflective type**



The **FX-305** and **FX-301(-HS)** have different sensing modes.  
**FX-305:** H-SP, FAST, STD, STDF, LONG, U-LG (no S-D mode)  
**FX-301(-HS):** S-D, H-SP (Note 1), FAST, STD, LONG (no STDF or U-LG mode)

Fibers are listed in alphabetic order. Refer to p.5~ "Fiber Selection" for details of each fiber.

Model No.	Sensing range (mm in) (Note 2, 3)							Dimensions
	Red LED							
	U-LG	LONG	STDF	STD	FAST	H-SP	S-D	
<b>FR-KV1</b>	15 to 370 <b>0.591 to 14.567</b>	15 to 330 <b>0.591 to 12.992</b>	15 to 240 <b>0.591 to 9.449</b>	15 to 210 <b>0.591 to 8.268</b>	15 to 170 <b>0.591 to 6.693</b>	15 to 80 <b>0.591 to 3.150</b>	15 to 90 <b>0.591 to 3.543</b>	P.98
<b>FR-KZ21</b>	20 to 200 <b>0.787 to 7.874</b>	20 to 200 <b>0.787 to 7.874</b>	20 to 200 <b>0.787 to 7.874</b>	20 to 200 <b>0.787 to 7.874</b>	20 to 200 <b>0.787 to 7.874</b>	20 to 200 <b>0.787 to 7.874</b>	20 to 200 <b>0.787 to 7.874</b>	P.98
<b>FR-KZ21E</b>	20 to 200 <b>0.787 to 7.874</b>	20 to 200 <b>0.787 to 7.874</b>	20 to 200 <b>0.787 to 7.874</b>	20 to 200 <b>0.787 to 7.874</b>	20 to 200 <b>0.787 to 7.874</b>	20 to 200 <b>0.787 to 7.874</b>	20 to 200 <b>0.787 to 7.874</b>	P.98
<b>FR-WKZ11</b>	100 to 910 <b>3.937 to 35.827</b>	100 to 730 <b>3.937 to 28.740</b>	100 to 600 <b>3.937 to 23.622</b>	100 to 520 <b>3.937 to 20.472</b>	100 to 460 <b>3.937 to 18.110</b>	—	—	P.98

- Notes: 1) Refer to p.35~ for the sensing ranges for the **FX-301-HS** in H-SP mode.  
 2) Note that the sensing range of the free-cut type fiber may be reduced by 20 % max. depending upon how the fiber is cut.  
 The sensing range of **FR-WKZ11** is specified for the **RF-13**. The sensing range of **FR-KZ21** and **FR-KZ21E** is specified for the attached reflector **RF-003**. The sensing range of **FR-KV1** is specified for the attached reflector.  
 3) The sensing range of retroreflective type is the possible setting range for the attached reflector. The fiber can detect an object less than setting range for the reflector. However, note that if there are any white or highly-reflective surfaces near the fiber head, reflected incident light may affect the fiber head. If this occurs, adjust the threshold value of the amplifier unit before use.

**FX-301 / FX-305 (Red LED type) sensing range (Note 1)**

**Reflective type**



The **FX-305** and **FX-301(-HS)** have different sensing modes.  
**FX-305:** H-SP, FAST, STD, STDF, LONG, U-LG (no S-D mode)  
**FX-301(-HS):** S-D, H-SP (Note 1), FAST, STD, LONG (no STDF or U-LG mode)

Fibers are listed in alphabetic order. Refer to p.5~ "Fiber Selection" for details of each fiber.

Model No.	Sensing range (mm in) (Note 2, 3)							Dimensions
	Red LED							
	U-LG	LONG	STDF	STD	FAST	H-SP	S-D	
<b>FD-30</b>	170 <b>6.693</b>	110 <b>4.331</b>	70 <b>2.756</b>	50 <b>1.969</b>	40 <b>1.575</b>	20 <b>0.787</b>	18 <b>0.709</b>	P.99
<b>FD-31</b>	150 <b>5.906</b>	95 <b>3.740</b>	63 <b>2.480</b>	45 <b>1.772</b>	35 <b>1.378</b>	17 <b>0.669</b>	16 <b>0.630</b>	P.99
<b>FD-40</b>	170 <b>6.693</b>	110 <b>4.331</b>	70 <b>2.756</b>	50 <b>1.969</b>	40 <b>1.575</b>	20 <b>0.787</b>	18 <b>0.709</b>	P.99
<b>FD-41</b>	150 <b>5.906</b>	95 <b>3.740</b>	63 <b>2.480</b>	45 <b>1.772</b>	35 <b>1.378</b>	17 <b>0.669</b>	16 <b>0.630</b>	P.99
<b>FD-60</b>	500 <b>19.685</b>	350 <b>13.780</b>	240 <b>9.449</b>	160 <b>6.299</b>	130 <b>5.118</b>	70 <b>2.756</b>	70 <b>2.756</b>	P.99
<b>FD-61</b>	440 <b>17.323</b>	320 <b>12.598</b>	205 <b>8.071</b>	145 <b>5.709</b>	105 <b>4.134</b>	65 <b>2.559</b>	60 <b>2.362</b>	P.99
<b>FD-A15</b>	230 <b>9.055</b>	200 <b>7.874</b>	150 <b>5.906</b>	150 <b>5.906</b>	100 <b>3.937</b>	45 <b>1.772</b>	50 <b>1.969</b>	P.99
<b>FD-AFM2</b>	290 <b>11.417</b>	220 <b>8.661</b>	135 <b>5.315</b>	110 <b>4.331</b>	78 <b>3.071</b>	35 <b>1.378</b>	39 <b>1.535</b>	P.99
<b>FD-AFM2E</b>	290 <b>11.417</b>	220 <b>8.661</b>	135 <b>5.315</b>	110 <b>4.331</b>	78 <b>3.071</b>	35 <b>1.378</b>	39 <b>1.535</b>	P.99
<b>FD-B8</b>	600 <b>23.622</b>	480 <b>18.898</b>	280 <b>11.024</b>	220 <b>8.661</b>	160 <b>6.299</b>	85 <b>3.346</b>	75 <b>2.953</b>	P.99
<b>FD-E12</b>	15 <b>0.591</b>	11 <b>0.433</b>	8 <b>0.315</b>	6 <b>0.236</b>	4 <b>0.157</b>	2 <b>0.079</b>	1 <b>0.039</b>	P.100
<b>FD-E22</b>	65 <b>2.559</b>	45 <b>1.772</b>	28 <b>1.102</b>	23 <b>0.906</b>	17 <b>0.669</b>	8 <b>0.315</b>	7 <b>0.276</b>	P.100
<b>FD-EG1</b>	50 <b>1.969</b>	38 <b>1.496</b>	25 <b>0.984</b>	18 <b>0.709</b>	14 <b>0.551</b>	5 <b>0.197</b>	6 <b>0.236</b>	P.100
<b>FD-EG2</b>	40 <b>1.575</b>	25 <b>0.984</b>	14 <b>0.551</b>	12 <b>0.472</b>	9 <b>0.354</b>	3 <b>0.118</b>	5 <b>0.197</b>	P.100
<b>FD-EG3</b>	20 <b>0.787</b>	15 <b>0.591</b>	9 <b>0.354</b>	8 <b>0.315</b>	5 <b>0.197</b>	2.5 <b>0.098</b>	3 <b>0.118</b>	P.100
<b>FD-EN500S1</b>	6.5 <b>0.256</b>	5 <b>0.197</b>	3 <b>0.118</b>	3 <b>0.118</b>	2 <b>0.079</b>	Cannot use	Cannot use	P.100
<b>FD-ENM1S1</b>	50 <b>1.969</b>	38 <b>1.496</b>	20 <b>0.787</b>	18 <b>0.709</b>	14 <b>0.551</b>	5 <b>0.197</b>	6 <b>0.236</b>	P.100
<b>FD-F4</b>	Applicable pipe diameter: Outer dia. $\phi 6$ to $\phi 26$ mm <b><math>\phi 0.236</math> to <math>\phi 1.024</math> in</b> transparent pipe [PFA (fluorine resin) or equivalently transparent pipe, wall thickness 1 mm <b>0.039 in</b> ]							P.100
<b>FD-F41</b>	Applicable pipe diameter: Outer dia. $\phi 6$ to $\phi 26$ mm <b><math>\phi 0.236</math> to <math>\phi 1.024</math> in</b> transparent pipe [PVC (vinyl chloride), fluorine resin, polycarbonate, acrylic, glass, wall thickness 1 to 3 mm <b>0.039 to 0.118 in</b> ]							P.100
<b>FD-F41Y</b>	$\phi 4$ mm <b><math>\phi 0.157</math> in</b> form Protective tube: fluorine resin, length 500 mm <b>19.685 in</b> (cuttable) Liquid surface not contacted: Beam received, Liquid surface contacted: Beam interrupted							P.101
<b>FD-F8Y</b>	—							P.101
<b>FD-FA90</b>	Applicable pipe diameter: Outer dia. $\phi 8$ mm <b><math>\phi 0.315</math> in</b> or more transparent pipe (When used with the tying bands: $\phi 8$ to $\phi 80$ mm <b><math>\phi 0.315</math> to <math>\phi 3.150</math> in</b> ) [PFA (fluorine resin), including translucent] Liquid absent: Beam received, Liquid present: Beam interrupted							P.101
<b>FD-FM2</b>	410 <b>16.142</b>	310 <b>12.205</b>	200 <b>7.874</b>	140 <b>5.512</b>	100 <b>3.937</b>	55 <b>2.165</b>	47 <b>1.850</b>	P.101
<b>FD-FM2S</b>	370 <b>14.567</b>	270 <b>10.630</b>	170 <b>6.693</b>	110 <b>4.331</b>	85 <b>3.346</b>	45 <b>1.772</b>	39 <b>1.535</b>	P.101
<b>FD-FM2S4</b>	370 <b>14.567</b>	270 <b>10.630</b>	170 <b>6.693</b>	110 <b>4.331</b>	85 <b>3.346</b>	45 <b>1.772</b>	39 <b>1.535</b>	P.101
<b>FD-G4</b>	150 <b>5.906</b>	110 <b>4.331</b>	65 <b>2.559</b>	55 <b>2.165</b>	42 <b>1.654</b>	15 <b>0.591</b>	19 <b>0.748</b>	P.101
<b>FD-G6</b>	150 <b>5.906</b>	110 <b>4.331</b>	65 <b>2.559</b>	55 <b>2.165</b>	42 <b>1.654</b>	15 <b>0.591</b>	19 <b>0.748</b>	P.102
<b>FD-G6X</b>	150 <b>5.906</b>	90 <b>3.543</b>	48 <b>1.890</b>	45 <b>1.772</b>	35 <b>1.378</b>	12 <b>0.472</b>	20 <b>0.787</b>	P.102
<b>FD-G40</b>	150 <b>5.906</b>	110 <b>4.331</b>	65 <b>2.559</b>	55 <b>2.165</b>	42 <b>1.654</b>	15 <b>0.591</b>	19 <b>0.748</b>	P.101
<b>FD-G60</b>	410 <b>16.142</b>	310 <b>12.205</b>	200 <b>7.874</b>	140 <b>5.512</b>	100 <b>3.937</b>	55 <b>2.165</b>	47 <b>1.850</b>	P.102
<b>FD-H13-FM2</b>	410 <b>16.142</b>	310 <b>12.205</b>	200 <b>7.874</b>	140 <b>5.512</b>	100 <b>3.937</b>	55 <b>2.165</b>	47 <b>1.850</b>	P.102
<b>FD-H18-L31</b>	0 to 20 <b>0 to 0.787</b>	0 to 15 <b>0 to 0.591</b>	0 to 10 <b>0 to 0.394</b>	0 to 10 <b>0 to 0.394</b>	1 to 8 <b>0.039 to 0.315</b>	Cannot use	2 to 6 <b>0.079 to 0.236</b>	P.102

- Notes: 1) Refer to p.35~ for the sensing ranges for the **FX-301-HS** in H-SP mode.  
 2) The standard sensing objects of the sensing ranges vary depending on the fibers.  
 3) Note that the sensing range of the free-cut type fiber may be reduced by 20 % max. depending upon how the fiber is cut.

**LIST OF FIBERS**

**FX-301 / FX-305 (Red LED type) sensing range (Note 1)**

**Reflective type**



The **FX-305** and **FX-301(-HS)** have different sensing modes.  
**FX-305:** H-SP, FAST, STD, STDF, LONG, U-LG (no S-D mode)  
**FX-301(-HS):** S-D, H-SP (Note 1), FAST, STD, LONG (no STDF or U-LG mode)

Fibers are listed in alphabetic order. Refer to p.5~ "Fiber Selection" for details of each fiber.

Model No.	Sensing range (mm in) (Note 2, 3)							Dimensions
	Red LED							
	U-LG	LONG	STDF	STD	FAST	H-SP	S-D	
<b>FD-H20-21</b>	300 11.811	270 10.630	150 5.906	140 5.512	100 3.937	35 1.378	47 1.850	P.102
<b>FD-H20-M1</b>	300 11.811	270 10.630	150 5.906	140 5.512	100 3.937	35 1.378	47 1.850	P.102
<b>FD-H25-L43</b>	3 to 28 0.118 to 1.102	3 to 25 0.118 to 0.984	4 to 23 0.157 to 0.906	4 to 20 0.118 to 0.787	4 to 19 0.118 to 0.748	4 to 16 0.118 to 0.630	4 to 16 0.118 to 0.630	P.103
<b>FD-H25-L45</b>	5 to 42 0.197 to 1.654	6 to 41 0.236 to 1.614	6 to 40 0.236 to 1.575	7 to 38 0.276 to 1.496	—	—	—	P.103
<b>FD-H30-KZ1V-S (Note 4)</b>	20 to 300 0.787 to 11.811	20 to 200 0.787 to 7.874	20 to 150 0.787 to 5.906	25 to 130 0.984 to 5.118	30 to 100 1.181 to 3.937	Cannot use	Cannot use	P.103
<b>FD-H30-L32</b>	0 to 20 0 to 0.787	0 to 15 0 to 0.591	0 to 10 0 to 0.394	0 to 10 0 to 0.394	1 to 8 0.039 to 0.315	Cannot use	2 to 6 0.079 to 0.236	P.103
<b>FD-H30-L32V-S (Note 4)</b>	0 to 11 0 to 0.433	0 to 8 0 to 0.315	1.5 to 6 0.059 to 0.236	1.5 to 5 0.059 to 0.197	2 to 4 0.079 to 0.157	Cannot use	Cannot use	P.103
<b>FD-H35-20S</b>	190 7.480	160 6.299	80 3.150	80 3.150	57 2.244	20 0.787	26 1.024	P.104
<b>FD-H35-M2</b>	300 11.811	270 10.630	150 5.906	140 5.512	100 3.937	35 1.378	47 1.850	P.104
<b>FD-H35-M2S6</b>	300 11.811	270 10.630	150 5.906	140 5.512	100 3.937	35 1.378	47 1.850	P.104
<b>FD-HF40Y</b>	ø4 mm ø0.157 in form Protective tube: fluorine resin, length:500 mm 19.685 in (allowable cutting) Liquid surface not contacted: Beam received, Liquid surface contacted: Beam interrupted							P.104
<b>FD-L4</b>	2 to 20 0.079 to 0.787 (Convergent point 6 0.236)	2.5 to 18 0.098 to 0.709 (Convergent point 6 0.236)	4 to 12 0.157 to 0.472 (Convergent point 6 0.236)	4 to 12 0.157 to 0.472 (Convergent point 6 0.236)	4.5 to 11 0.177 to 0.433 (Convergent point 6 0.236)	5 to 8.5 0.197 to 0.335 (Convergent point 6 0.236)	4.8 to 9.5 0.189 to 0.374 (Convergent point 6 0.236)	P.104
<b>FD-L41</b>	2 to 19 0.079 to 0.748 (Convergent point 8 0.315)	2.5 to 18 0.098 to 0.709 (Convergent point 8 0.315)	3 to 16 0.118 to 0.630 (Convergent point 8 0.315)	3 to 16 0.118 to 0.630 (Convergent point 8 0.315)	3.5 to 15 0.138 to 0.591 (Convergent point 8 0.315)	Cannot use	Cannot use	P.104
<b>FD-L43</b>	—	—	—	0 to 23 0 to 0.906	—	—	—	P.104
<b>FD-L44</b>	0 to 8.2 0 to 0.323	0 to 7 0 to 0.276	0 to 6.5 0 to 0.256	0 to 6 0 to 0.236	0 to 5.7 0 to 0.224	0 to 5 0 to 0.197	0 to 5.2 0 to 0.205	P.104
<b>FD-L44S</b>	0 to 4.7 0 to 0.185	0 to 4.5 0 to 0.177	0 to 4 0 to 0.157	0 to 4 0 to 0.157	0 to 3.8 0 to 0.150	0 to 3 0 to 0.118	0 to 3.5 0 to 0.138	P.104
<b>FD-L45</b>	0 to 50 0 to 1.969	0 to 36 0 to 1.417	0 to 33 0 to 1.299	0 to 30 0 to 1.181	0 to 30 0 to 1.181	0 to 15 0 to 0.591	0 to 21 0 to 0.827	P.104
<b>FD-L45A</b>	10 to 33 0.394 to 1.299 (Note 5)	10 to 33 0.394 to 1.299 (Note 5)	10 to 32 0.394 to 1.260 (Note 5)	10 to 32 0.394 to 1.260 (Note 5)	10 to 32 0.394 to 1.260 (Note 5)	13 to 18 0.512 to 0.709 (Note 5)	13 to 18 0.512 to 0.709 (Note 5)	P.105
<b>FD-L46</b>	12 to 50 0.472 to 1.969	12.5 to 37.5 0.492 to 1.476	15 to 36 0.591 to 1.417	15 to 35 0.591 to 1.378	16 to 29 0.630 to 1.142	Cannot use	Cannot use	P.105
<b>FD-L47</b>	30 1.181	30 1.181	30 1.181	30 1.181	1 to 28 0.039 to 1.102	2 to 27 0.079 to 1.063	2 to 27 0.079 to 1.063	P.105
<b>FD-NFM2</b>	140 5.512	90 3.543	60 2.362	45 1.772	35 1.378	16 0.630	16 0.630	P.105
<b>FD-NFM2S</b>	140 5.512	90 3.543	60 2.362	45 1.772	35 1.378	16 0.630	16 0.630	P.105
<b>FD-NFM2S4</b>	140 5.512	90 3.543	60 2.362	45 1.772	35 1.378	16 0.630	16 0.630	P.105
<b>FD-P2</b>	80 3.150	50 1.969	30 1.181	25 0.984	19 0.748	7.5 0.295	9 0.354	P.105
<b>FD-P40</b>	50 1.969	36 1.417	20 0.787	18 0.709	14 0.551	5.5 0.217	6 0.236	P.105
<b>FD-P50</b>	130 5.118	90 3.543	55 2.165	45 1.772	30 1.181	13 0.512	16 0.630	P.105
<b>FD-P60</b>	130 5.118	90 3.543	55 2.165	45 1.772	30 1.181	13 0.512	16 0.630	P.105
<b>FD-P80</b>	300 11.811	220 8.661	130 5.118	100 3.937	70 2.756	30 1.181	35 1.378	P.105
<b>FD-P81X</b>	270 10.630	185 7.283	100 3.937	80 3.150	60 2.362	30 1.181	35 1.378	P.106
<b>FD-R80</b>	240 9.449	185 7.283	110 4.331	85 3.346	60 2.362	25 0.984	30 1.181	P.106
<b>FD-S30</b>	170 6.693	110 4.331	70 2.756	50 1.969	40 1.575	20 0.787	18 0.709	P.106
<b>FD-S31</b>	150 5.906	95 3.740	63 2.480	45 1.772	35 1.378	17 0.669	16 0.630	P.106
<b>FD-S80</b>	370 14.567	270 10.630	170 6.693	110 4.331	85 3.346	45 1.772	39 1.535	P.106
<b>FD-SFM2SV2</b>	170 6.693	100 3.937	55 2.165	45 1.772	32 1.260	15 0.591	16 0.630	P.106
<b>FD-SNFM2</b>	140 5.512	90 3.543	60 2.362	45 1.772	35 1.378	16 0.630	16 0.630	P.106
<b>FD-T40</b>	140 5.512	90 3.543	60 2.362	45 1.772	35 1.378	16 0.630	16 0.630	P.106
<b>FD-T80</b>	370 14.567	270 10.630	170 6.693	110 4.331	85 3.346	45 1.772	39 1.535	P.106
<b>FD-V41</b>	80 3.150	55 2.165	30 1.181	25 0.984	17 0.669	8 0.315	9 0.354	P.106
<b>FD-W8</b>	250 9.843	190 7.480	110 4.331	90 5.943	60 2.362	25 0.984	32 1.260	P.107
<b>FD-W44</b>	40 1.575	30 1.181	18 0.709	15 0.591	12 0.472	4.5 0.177	5 0.197	P.107
<b>FD-WG4</b>	85 3.346	65 2.559	37 1.457	32 1.260	25 0.984	10 0.394	11 0.433	P.107
<b>FD-WKZ1</b>	20 to 660 0.787 to 25.984	20 to 480 0.787 to 18.898	20 to 300 0.787 to 11.811	20 to 230 0.787 to 9.055	20 to 170 0.787 to 6.693	25 to 90 0.984 to 3.543	25 to 100 0.984 to 3.937	P.107
<b>FD-WL41</b>	6.5 to 14.5 0.256 to 0.571 (Convergent point 8 0.315)	6.5 to 14 0.256 to 0.551 (Convergent point 8 0.315)	7 to 14 0.276 to 0.551 (Convergent point 8 0.315)	7 to 12 0.276 to 0.472 (Convergent point 8 0.315)	7.5 to 12 0.295 to 0.472 (Convergent point 8 0.315)	Cannot use	Cannot use	P.107
<b>FD-WL48</b>	0.5 to 8.5 0.020 to 0.335	0.5 to 7.5 0.020 to 0.295	1 to 6.5 0.039 to 0.256	1 to 5.5 0.039 to 0.217	1 to 5 0.039 to 0.197	Cannot use	Cannot use	P.107
<b>FD-WS8</b>	250 9.843	190 7.480	110 4.331	90 3.543	60 2.362	25 0.984	32 1.260	P.107
<b>FD-WSG4</b>	85 3.346	65 2.559	37 1.457	32 1.260	25 0.984	10 0.394	11 0.433	P.107
<b>FD-WT4</b>	40 1.575	30 1.181	18 0.709	15 0.591	12 0.472	4.5 0.177	5 0.197	P.107
<b>FD-WT8</b>	250 9.843	190 7.480	110 4.331	90 3.543	60 2.362	25 0.984	32 1.260	P.107
<b>FD-WV42</b>	20 0.787	15 0.591	8.5 0.335	7 0.276	5 0.197	Cannot use	Cannot use	P.108
<b>FD-WZ4</b>	1 to 50 0.039 to 1.969	1.5 to 34 0.059 to 1.339	2 to 24 0.079 to 0.945	3 to 17 0.118 to 0.669	3 to 10 0.118 to 0.394	—	—	P.108
<b>FD-WZ4HB</b>	1 to 70 0.039 to 2.756	1 to 46 0.039 to 1.811	1 to 32.2 0.039 to 1.268	2.5 to 23 0.098 to 0.906	2.5 to 15 0.098 to 0.591	3 to 7 0.118 to 0.276	3 to 7 0.118 to 0.276	P.108
<b>FD-WZ7</b>	200 7.874	120 4.724	1 to 84 0.039 to 3.307	1 to 60 0.039 to 2.362	1.5 to 35 0.059 to 1.378	2.5 to 18 0.098 to 0.709	2.5 to 18 0.098 to 0.709	P.108
<b>FD-WZ7HB</b>	0.5 to 270 0.020 to 10.630	0.5 to 180 0.020 to 7.087	1 to 126 0.039 to 4.961	1 to 90 0.039 to 3.543	1 to 70 0.039 to 2.756	1 to 35 0.039 to 1.378	1 to 35 0.039 to 1.378	P.108

- Notes: 1) Refer to p.35~ for the sensing ranges for the **FX-301(-HS)** in H-SP mode.
- 2) The standard sensing objects of the sensing ranges vary depending on the fibers.
- 3) Note that the sensing range of the free-cut type fiber may be reduced by 20 % max. depending upon how the fiber is cut.
- 4) Sold as a set comprising vacuum type fiber + photo-terminal (**FV-BR1**) + fiber at atmospheric side (**FT-J8**).
- 5) Sensing distance varies depending on the sensing object's inclination.

FIBER SENSORS

LASER SENSORS

PHOTO-ELECTRIC SENSORS

MICRO PHOTO-ELECTRIC SENSORS

AREA SENSORS

LIGHT CURTAINS

PRESSURE / FLOW SENSORS

INDUCTIVE PROXIMITY SENSORS

PARTICULAR USE SENSORS

SENSOR OPTIONS

WIRE-SAVING UNITS

WIRE-SAVING SYSTEMS

MEASUREMENT SENSORS

STATIC CONTROL DEVICES

ENDOSCOPE

LASER MARKERS

PLC / TERMINALS

HUMAN MACHINE INTERFACES

ENERGY CONSUMPTION VISUALIZATION COMPONENTS

FA COMPONENTS

MACHINE VISION SYSTEMS

UV CURING SYSTEMS

Selection Guide

Fibers

Amplifiers

**FX-500**

**FX-100**

**FX-300**

**FX-410**

**FX-311**

FX-301-F7/  
FX-301-F

**SENSING RANGE OF BLUE LED / GREEN LED / INFRARED LED**

**Thru-beam type (One pair set)** 

Fibers are listed in alphabetic order. Refer to p.5~ for details of each fiber.

Model No.	Sensing range (mm in) (Note 1)									Dimensions
	FX-301B			FX-301G			FX-301H (Note 2)			
	LONG	STD	FAST	LONG	STD	FAST	LONG	STD	FAST	
FT-30	55 2.165	28 1.102	18 0.709	28 1.102	13 0.512	9 0.354	25 0.984	13 0.512	9 0.354	P.90
FT-31	50 1.969	25 0.984	16 0.630	24 0.945	12 0.472	8 0.315	23 0.906	11 0.433	8 0.315	P.90
FT-40	155 6.102	76 2.992	45 1.772	90 3.543	40 1.575	26 1.024	80 3.150	43 1.693	27 1.063	P.90
FT-41	150 5.906	75 2.953	40 1.575	70 2.756	35 1.378	24 0.945	50 1.969	25 0.984	18 0.709	P.90
FT-42	150 5.906	75 2.953	40 1.575	80 3.150	35 1.378	24 0.945	75 2.953	40 1.575	25 0.984	P.90
FT-A8	600 23.622	300 11.811	220 8.661	300 11.811	150 5.906	110 4.331	220 8.661	110 4.331	80 3.150	P.90
FT-A30	2,400 94.488	1,200 47.244	700 27.559	1,200 47.244	600 23.622	350 13.780	800 31.496	400 15.748	240 9.449	P.90
FT-AFM2	120 4.724	60 2.362	40 1.575	60 2.362	30 1.181	20 0.787	48 1.890	24 0.945	18 0.709	P.90
FT-AFM2E	120 4.724	60 2.362	40 1.575	60 2.362	30 1.181	20 0.787	48 1.890	24 0.945	18 0.709	P.90
FT-B8	220 8.661	110 4.331	75 2.953	110 4.331	55 2.165	40 1.575	100 3.937	50 1.969	30 1.181	P.90
FT-E12	3 0.118	2 0.079	1 0.039	1 0.039	—	—	4 0.157	2 0.079	1.5 0.059	P.91
FT-E13	2 0.079	1 0.039	—	1 0.039	—	—	2 0.079	1 0.039	—	P.91
FT-E22	14 0.551	7 0.276	4 0.157	6 0.236	3 0.118	2 0.079	10 0.394	5 0.197	3 0.118	P.91
FT-E23	8 0.315	4 0.157	3 0.118	4 0.157	2 0.079	1 0.039	10 0.394	5 0.197	3 0.118	P.91
FT-FM2	150 5.906	75 2.953	40 1.575	70 2.756	35 1.378	24 0.945	50 1.969	25 0.984	18 0.709	P.91
FT-FM2S	150 5.906	75 2.953	40 1.575	70 2.756	35 1.378	24 0.945	50 1.969	25 0.984	18 0.709	P.91
FT-FM2S4	150 5.906	75 2.953	40 1.575	70 2.756	35 1.378	24 0.945	50 1.969	25 0.984	18 0.709	P.91
FT-FM10L	5,400 212.598	2,700 106.299	1,900 74.803	2,800 110.236	1,400 55.118	1,000 39.370	2,400 94.488 (Note 3)	1,200 47.244 (Note 3)	900 35.433 (Note 3)	P.91
FT-H13-FM2	72 2.835	36 1.417	26 1.024	32 1.260	16 0.630	10 0.394	70 2.756	35 1.378	25 0.984	P.91
FT-H20-J20-S (Note 4)	60 2.362	20 0.787	—	35 1.378	—	—	20 0.787	—	—	P.92
FT-H20-J30-S (Note 4)	60 2.362	20 0.787	—	35 1.378	—	—	20 0.787	—	—	P.92
FT-H20-J50-S (Note 4)	60 2.362	20 0.787	—	35 1.378	—	—	20 0.787	—	—	P.92
FT-H20-M1	100 3.937	50 1.969	35 1.378	50 1.969	25 0.984	18 0.709	550 21.654	280 11.024	160 6.299	P.92
FT-H20-VJ50-S (Note 4)	85 3.346	30 1.181	—	50 1.969	—	—	30 1.181	—	—	P.92
FT-H20-VJ80-S (Note 4)	85 3.346	30 1.181	—	50 1.969	—	—	30 1.181	—	—	P.92
FT-H20W-M1	44 1.732	22 0.866	14 0.551	22 0.866	11 0.433	7 0.276	220 8.661	100 3.937	70 2.756	P.92
FT-H30-M1V-S (Note 5)	40 1.575	20 0.787	—	20 0.787	—	—	20 0.787	—	—	P.92
FT-H35-M2	100 3.937	50 1.969	35 1.378	50 1.969	25 0.984	18 0.709	550 21.654	280 11.024	160 6.299	P.92
FT-H35-M2S6	100 3.937	50 1.969	35 1.378	50 1.969	25 0.984	18 0.709	550 21.654	280 11.024	160 6.299	P.92
FT-HL80Y	80 3.150	40 1.575	25 0.984	110 4.331	55 2.165	40 1.575	1,100 43.307	550 21.654	350 13.780	P.92
FT-K8	400 15.748	200 7.874	130 5.118	200 7.874	100 3.937	65 2.559	150 5.906	75 2.953	40 1.575	P.93
FT-KV1	80 3.150	35 1.378	10 0.394	—	—	—	—	—	—	P.93
FT-KV8	400 15.748	200 7.874	130 5.118	200 7.874	100 3.937	65 2.559	150 5.906	75 2.953	40 1.575	P.93
FT-L80Y	160 6.299	80 3.150	50 1.969	160 6.299	80 3.150	50 1.969	400 15.748	200 7.874	150 5.906	P.93
FT-NFM2	50 1.969	25 0.984	16 0.630	24 0.945	12 0.472	8 0.315	16 0.630	8 0.315	5 0.197	P.93
FT-NFM2S	50 1.969	25 0.984	16 0.630	24 0.945	12 0.472	8 0.315	16 0.630	8 0.315	5 0.197	P.93
FT-NFM2S4	50 1.969	25 0.984	16 0.630	24 0.945	12 0.472	8 0.315	16 0.630	8 0.315	5 0.197	P.93
FT-P2	36 1.417	18 0.709	14 0.551	20 0.787	10 0.394	8 0.315	18 0.709	9 0.354	7 0.276	P.93
FT-P40	32 1.260	13 0.512	12 0.472	18 0.709	9 0.354	7 0.276	14 0.551	7 0.276	5 0.197	P.93
FT-P60	50 1.969	25 0.984	18 0.709	26 1.024	13 0.512	8 0.315	20 0.787	10 0.394	7 0.276	P.93

- Notes: 1) Note that the sensing range of the free-cut type fiber may be reduced by 20 % max. depending upon how the fiber is cut.  
 2) Because infrared types are easily affected by humidity, please ask assistance when using them in a humid environment or in an environment with varying humidity.  
 3) Sensing range when fiber length is 2 m 6.562 ft. When fiber length is 10 m 32.81 ft, the beam attenuates and cannot be used.  
 4) Heat-resistant joint fibers and ordinary-temperature fibers (FT-FM2) are sold as a set.  
 5) Sold as a set comprising vacuum type fiber + photo-terminal (FV-BR1) + fiber at atmospheric side (FT-J8).

**SENSING RANGE OF BLUE LED / GREEN LED / INFRARED LED**

**Thru-beam type (One pair set)** 

Fibers are listed in alphabetic order. Refer to p.5~ "Fiber Selection" for details of each fiber.

Model No.	Sensing range (mm in) (Note 1)									Dimensions
	FX-301B			FX-301G			FX-301H (Note 2)			
	LONG	STD	FAST	LONG	STD	FAST	LONG	STD	FAST	
FT-P80	130 5.118	65 2.559	45 1.772	70 2.756	35 1.378	25 0.984	56 2.205	28 1.102	20 0.787	P.93
FT-P81X	130 5.118	64 2.520	45 1.772	64 2.520	32 1.260	25 0.984	56 2.205	28 1.102	20 0.787	P.94
FT-PS1	14 0.551	7 0.276	4 0.157	6 0.236	3 0.118	2 0.079	14 0.551	7 0.276	4 0.157	P.93
FT-R80	85 3.346	42 1.654	28 1.102	44 1.732	22 0.866	16 0.630	32 1.260	16 0.630	12 0.472	P.94
FT-S20	55 2.165	28 1.102	18 0.709	28 1.102	13 0.512	9 0.354	25 0.984	13 0.512	9 0.354	P.94
FT-S21	50 1.969	25 0.984	16 0.630	24 0.945	12 0.472	8 0.315	23 0.906	11 0.433	8 0.315	P.94
FT-S30	155 6.102	76 2.992	45 1.772	90 3.543	40 1.575	26 1.024	80 3.150	43 1.693	27 1.063	P.94
FT-SFM2	150 5.906	75 2.953	40 1.575	70 2.756	35 1.378	24 0.945	50 1.969	25 0.984	18 0.709	P.94
FT-SFM2L	400 15.748	200 7.874	130 5.118	200 7.874	100 3.937	65 2.559	155 6.102	77 3.031	55 2.165	P.94
FT-SFM2SV2	80 3.150	40 1.575	28 1.102	40 1.575	20 0.787	14 0.551	30 1.181	15 0.591	12 0.472	P.94
FT-SNFM2	50 1.969	25 0.984	16 0.630	24 0.945	12 0.472	8 0.315	16 0.630	8 0.315	5 0.197	P.95
FT-T80	150 5.906	75 2.953	40 1.575	70 2.756	35 1.378	24 0.945	50 1.969	25 0.984	18 0.709	P.95
FT-V10	400 15.748	200 7.874	130 5.118	200 7.874	100 3.937	65 2.559	150 5.906	75 2.953	40 1.575	P.95
FT-V22	50 1.969	25 0.984	16 0.630	26 1.024	13 0.512	8 0.315	44 1.732	22 0.866	15 0.591	P.95
FT-V41	28 1.102	14 0.551	10 0.394	14 0.551	7 0.276	5 0.197	10 0.394	5 0.197	3 0.118	P.95
FT-V80Y	120 4.724	60 2.362	35 1.378	80 3.150	40 1.575	25 0.984	75 2.953	38 1.496	24 0.945	P.95
FT-W4	16 0.630	8 0.315	5 0.197	10 0.394	5 0.197	3 0.118	8 0.315	4 0.157	2.5 0.098	P.95
FT-W8	90 3.543	45 1.772	30 1.181	56 2.205	28 1.102	20 0.787	42 1.654	21 0.827	15 0.591	P.95
FT-WA8	600 23.622	300 11.811	220 8.661	300 11.811	150 5.906	110 4.331	220 8.661	110 4.331	80 3.150	P.95
FT-WA30	2,400 94.488	1,200 47.244	700 27.560	1,200 47.244	600 23.622	350 13.780	800 31.496	400 15.748	240 9.449	P.95
FT-WKV8	300 11.811	150 5.906	100 3.937	160 6.299	80 3.150	60 2.362	150 5.906	75 2.953	45 1.772	P.96
FT-WR80	90 3.543	45 1.772	30 1.181	56 2.205	28 1.102	20 0.787	48 1.890	22 0.866	14 0.551	P.96
FT-WR80L	240 9.449	120 4.724	90 3.543	120 4.724	60 2.362	40 1.575	132 5.197	65 2.559	42 1.654	P.96
FT-WS3	90 3.543	45 1.772	30 1.181	56 2.205	28 1.102	20 0.787	————	————	————	P.96
FT-WS4	16 0.630	8 0.315	5 0.197	10 0.394	5 0.197	3 0.118	8 0.315	4 0.157	2.5 0.098	P.96
FT-WS8	90 3.543	45 1.772	30 1.181	56 2.205	28 1.102	20 0.787	42 1.654	21 0.827	15 0.591	P.96
FT-WS8L	240 9.449	120 4.724	90 3.543	120 4.724	60 2.362	40 1.575	110 4.331	55 2.165	35 1.378	P.96
FT-WV42	————	————	————	————	————	————	————	————	————	P.96
FT-WZ4	35 1.378	15 0.591	9 0.354	18 0.709	8 0.315	4.8 0.189	43 1.693	15 0.591	9 0.354	P.96
FT-WZ4HB	32 1.260	15 0.591	9.6 0.378	16 0.630	9 0.354	5.4 0.213	40 1.575	15 0.591	12 0.472	P.97
FT-WZ7	80 3.150	40 1.575	24 0.945	54 2.216	27 1.063	16.2 0.638	54 2.126	27 1.063	16.2 0.638	P.97
FT-WZ7HB	100 3.937	50 1.969	30 1.181	56 2.205	28 1.102	16.8 0.661	56 2.205	28 1.102	16.8 0.661	P.97
FT-WZ8	80 3.150	40 1.575	25 0.984	40 1.575	20 0.787	13 0.512	36 1.417	18 0.709	12 0.472	P.97
FT-WZ8E	240 9.449	120 4.724	80 3.150	120 4.724	60 2.362	40 1.575	100 3.937	50 1.969	30 1.181	P.97
FT-WZ8H	400 15.748	200 7.874	140 5.512	200 7.874	100 3.937	70 2.756	180 7.087	90 3.543	65 2.559	P.97
FT-Z8	120 4.724	60 2.362	40 1.575	60 2.362	30 1.181	22 0.866	46 1.811	23 0.906	16 0.630	P.97
FT-Z8E	400 15.748	200 7.874	140 5.512	200 7.874	100 3.937	65 2.559	140 5.512	70 2.756	50 1.969	P.97
FT-Z8H	560 22.047	280 11.024	200 7.874	200 7.874	100 3.937	65 2.559	180 7.087	90 3.543	65 2.559	P.97
FT-Z802Y	320 12.598	160 6.299	120 4.724	160 6.299	80 3.150	60 2.362	320 12.598	160 6.299	120 4.724	P.97

Notes: 1) Note that the sensing range of the free-cut type fiber may be reduced by 20 % max. depending upon how the fiber is cut.  
 2) Because infrared types are easily affected by humidity, please ask assistance when using them in a humid environment or in an environment with varying humidity.

FIBER SENSORS

LASER SENSORS

PHOTO-ELECTRIC SENSORS

MICRO PHOTO-ELECTRIC SENSORS

AREA SENSORS

LIGHT CURTAINS

PRESSURE / FLOW SENSORS

INDUCTIVE PROXIMITY SENSORS

PARTICULAR USE SENSORS

SENSOR OPTIONS

SMALL WIRE-SAVING UNITS

WIRE-SAVING SYSTEMS

MEASUREMENT SENSORS

STATIC CONTROL DEVICES

ENDOSCOPE

LASER MARKERS

PLC / TERMINALS

HUMAN MACHINE INTERFACES

ENERGY CONSUMPTION VISUALIZATION COMPONENTS

FA COMPONENTS

MACHINE VISION SYSTEMS

UV CURING SYSTEMS

Selection Guide

Fibers

Amplifiers

FX-500

FX-100

FX-300

FX-410

FX-311

FX-301-F7/ FX-301-F

**SENSING RANGE OF BLUE LED / GREEN LED / INFRARED LED**

**Retroreflective type** 

Fibers are listed in alphabetic order. Refer to p.5~ "Fiber Selection" for details of each fiber.

Model No.	Sensing range (mm in) (Note 1, 2)									Dimensions
	FX-301B			FX-301G			FX-301H			
	LONG	STD	FAST	LONG	STD	FAST	LONG	STD	FAST	
<b>FR-KV1</b>	—	—	—	—	—	—	—	—	—	P.98
<b>FR-KZ21</b>	20 to 200 0.787 to 7.874	20 to 120 0.787 to 4.724	20 to 90 0.787 to 3.543	20 to 130 0.787 to 5.118	20 to 80 0.787 to 3.150	20 to 50 0.787 to 1.969	20 to 130 0.787 to 5.118	20 to 70 0.787 to 2.756	—	P.98
<b>FR-KZ21E</b>	20 to 160 0.787 to 6.299	20 to 100 0.787 to 3.937	20 to 60 0.787 to 2.362	20 to 110 0.787 to 4.331	—	—	20 to 90 0.787 to 3.543	—	—	P.98
<b>FR-WKZ11</b>	—	—	—	—	—	—	100 to 340 3.937 to 13.386	—	—	P.98

Notes: 1) Note that the sensing range of the free-cut type fiber may be reduced by 20 % max. depending upon how the fiber is cut.  
 2) The sensing range of retroreflective type is the possible setting range for the attached reflector. The fiber can detect an object less than setting range for the reflector. However, note that if there are any white or highly-reflective surfaces near the fiber head, reflected incident light may affect the fiber head. If this occurs, adjust the threshold value of the amplifier unit before use.

**Reflective type** 

Fibers are listed in alphabetic order. Refer to p.5~ "Fiber Selection" for details of each fiber.

Model No.	Sensing range (mm in) (Note 1, 2)									Dimensions
	FX-301B			FX-301G			FX-301H			
	LONG	STD	FAST	LONG	STD	FAST	LONG	STD	FAST	
<b>FD-30</b>	19 0.748	9 0.354	6 0.236	9 0.354	4.5 0.177	2.5 0.098	8 0.315	4 0.157	2.5 0.098	P.99
<b>FD-31</b>	18 0.709	8 0.315	5 0.197	8 0.315	4 0.157	2 0.079	7 0.276	3 0.118	2 0.079	P.99
<b>FD-40</b>	19 0.748	9 0.354	6 0.236	9 0.354	4.5 0.177	2.5 0.098	8 0.315	4 0.157	2.5 0.098	P.99
<b>FD-41</b>	18 0.709	8 0.315	5 0.197	8 0.315	4 0.157	2 0.079	7 0.276	3 0.118	2 0.079	P.99
<b>FD-60</b>	55 2.165	28 1.102	18 0.709	30 1.181	15 0.591	10 0.394	30 1.181	15 0.591	10 0.394	P.99
<b>FD-61</b>	48 1.890	24 0.945	16 0.630	26 1.024	13 0.512	8 0.315	27 1.063	12 0.472	8 0.315	P.99
<b>FD-A15</b>	25 0.984	15 0.591	—	—	—	—	—	—	—	P.99
<b>FD-AFM2</b>	40 1.575	20 0.787	13 0.512	18 0.709	9 0.354	5 0.197	12 0.472	6 0.236	4 0.157	P.99
<b>FD-AFM2E</b>	40 1.575	20 0.787	13 0.512	18 0.709	9 0.354	5 0.197	12 0.472	6 0.236	4 0.157	P.99
<b>FD-B8</b>	80 3.150	40 1.575	26 1.024	42 1.654	21 0.827	14 0.551	26 1.024	13 0.512	9 0.354	P.99
<b>FD-E12</b>	2 0.079	1 0.039	—	1 0.039	—	—	1 0.039	—	—	P.100
<b>FD-E22</b>	6 0.236	3 0.118	2 0.079	3 0.118	1.5 0.059	1 0.039	6 0.236	3 0.118	2 0.079	P.100
<b>FD-EG1</b>	6 0.236	3 0.118	2 0.079	3 0.118	1.5 0.059	1 0.039	10 0.394	5 0.197	3 0.118	P.100
<b>FD-EG2</b>	5 0.197	2 0.079	1 0.039	2 0.079	1 0.039	—	6 0.236	3 0.118	2 0.079	P.100
<b>FD-EG3</b>	2 0.079	1 0.039	—	1 0.039	—	—	3 0.118	1.5 0.059	1 0.039	P.100
<b>FD-EN500S1</b>	—	—	—	—	—	—	—	—	—	P.100
<b>FD-ENM1S1</b>	6 0.236	3 0.118	2 0.079	3 0.118	1.5 0.059	1 0.039	4 0.157	2 0.079	1.5 0.059	P.100
<b>FD-F4</b>	Applicable pipe diameter: Outer dia. ø6 to ø26 mm ø0.236 to ø1.024 in transparent pipe [PFA (fluorine resin) or equivalently transparent pipe, wall thickness 1 mm 0.039 in]									P.100
<b>FD-F41</b>	Applicable pipe diameter: Outer dia. ø6 to ø26 mm ø0.236 to ø1.024 in transparent pipe [PVC (vinyl chloride), fluorine resin, polycarbonate, acrylic, glass, wall thickness 1 to 3 mm 0.039 to 0.118 in]									P.100
<b>FD-F41Y</b>	ø4 mm ø0.157 in form Protective tube: fluorine resin, length 500 mm 19.685 in (cuttable) Liquid surface not contacted: Beam received, Liquid surface contacted: Beam interrupted									P.101
<b>FD-F8Y</b>	—	—	—	—	—	—	—	—	—	P.101
<b>FD-FA90</b>	Applicable pipe diameter: Outer dia. ø8 mm ø0.315 in or more transparent pipe (When used with the tying bands: ø8 to ø80 mm ø0.315 to ø3.150 in) [PFA (fluorine resin), including translucent] Liquid absent: Beam received, Liquid present: Beam interrupted									P.101
<b>FD-FM2</b>	46 1.811	23 0.906	15 0.591	24 0.945	12 0.472	8 0.315	20 0.787	10 0.394	7 0.276	P.101
<b>FD-FM2S</b>	46 1.811	23 0.906	15 0.591	24 0.945	12 0.472	8 0.315	20 0.787	10 0.394	7 0.276	P.101
<b>FD-FM2S4</b>	46 1.811	23 0.906	15 0.591	24 0.945	12 0.472	8 0.315	20 0.787	10 0.394	7 0.276	P.101
<b>FD-G4</b>	22 0.866	11 0.433	8 0.315	12 0.472	6 0.236	4 0.157	7 0.276	3.5 0.138	2 0.079	P.101
<b>FD-G6</b>	22 0.866	11 0.433	8 0.315	12 0.472	6 0.236	4 0.157	7 0.276	3.5 0.138	2 0.079	P.102
<b>FD-G6X</b>	33 1.299	11 0.433	6 0.236	12 0.472	6 0.236	4 0.157	7 0.276	3.5 0.138	2 0.079	P.102
<b>FD-G40</b>	22 0.866	11 0.433	8 0.315	12 0.472	6 0.236	4 0.157	7 0.276	3.5 0.138	2 0.079	P.101
<b>FD-G60</b>	46 1.811	23 0.906	15 0.591	24 0.945	12 0.472	8 0.315	20 0.787	10 0.394	7 0.276	P.102
<b>FD-H13-FM2</b>	20 0.787	11 0.433	7 0.276	20 0.787	11 0.433	7 0.276	25 0.984	12 0.472	8 0.315	P.102
<b>FD-H18-L31</b>	—	—	—	—	—	—	—	—	—	P.102
<b>FD-H20-21</b>	36 1.417	18 0.709	12 0.472	20 0.787	10 0.394	7 0.276	140 5.512	70 2.756	45 1.772	P.102
<b>FD-H20-M1</b>	36 1.417	18 0.709	12 0.472	20 0.787	10 0.394	7 0.276	140 5.512	70 2.756	45 1.772	P.102

Notes: 1) The standard sensing objects of the sensing ranges vary depending on the fibers.  
 2) Note that the sensing range of the free-cut type fiber may be reduced by 20 % max. depending upon how the fiber is cut.

- FIBER SENSORS
- LASER SENSORS
- PHOTO-ELECTRIC SENSORS
- MICRO PHOTO-ELECTRIC SENSORS
- AREA SENSORS
- LIGHT CURTAINS
- PRESSURE / FLOW SENSORS
- INDUCTIVE PROXIMITY SENSORS
- PARTICULAR USE SENSORS
- SENSOR OPTIONS
- SIMPLE WIRE-SAVING UNITS
- WIRE-SAVING SYSTEMS
- MEASUREMENT SENSORS
- STATIC CONTROL DEVICES
- ENDOSCOPE
- LASER MARKERS
- PLC / TERMINALS
- HUMAN MACHINE INTERFACES
- ENERGY CONSUMPTION VISUALIZATION COMPONENTS
- FA COMPONENTS
- MACHINE VISION SYSTEMS
- UV CURING SYSTEMS
- Selection Guide
- Fibers
- Amplifiers
- FX-500
- FX-100
- FX-300
- FX-410
- FX-311
- FX-301-F7/ FX-301-F

**SENSING RANGE OF BLUE LED / GREEN LED / INFRARED LED**

**Reflective type** 

Fibers are listed in alphabetic order. Refer to p.5~ "Fiber Selection" for details of each fiber.

Model No.	Sensing range (mm in) (Note 1, 2)									Dimensions
	FX-301B			FX-301G			FX-301H			
	LONG	STD	FAST	LONG	STD	FAST	LONG	STD	FAST	
FD-H25-L43	—	—	—	—	—	—	—	—	—	P.103
FD-H25-L45	—	—	—	—	—	—	—	—	—	P.103
FD-H30-KZ1V-S (Note 3)	30 to 40 1.181 to 1.575	—	—	—	—	—	—	—	—	P.103
FD-H30-L32	—	—	—	—	—	—	—	—	—	P.103
FD-H30-L32V-S (Note 3)	—	—	—	—	—	—	—	—	—	P.103
FD-H35-20S	22 0.866	11 0.433	7 0.276	12 0.472	6 0.236	4 0.157	80 3.150	40 1.575	28 1.102	P.104
FD-H35-M2	36 1.417	18 0.709	12 0.472	20 0.787	10 0.394	7 0.276	140 5.512	70 2.756	45 1.772	P.104
FD-H35-M2S6	36 1.417	18 0.709	12 0.472	20 0.787	10 0.394	7 0.276	140 5.512	70 2.756	45 1.772	P.104
FD-HF40Y	ø4 mm ø0.157 in form Protective tube: fluorine resin, length:500 mm 19.685 in (allowable cutting) Liquid surface not contacted: Beam received, Liquid surface contacted: Beam interrupted									P.104
FD-L4	4.5 to 9.5 0.177 to 0.374 (Convergent point 6 0.236)	5 to 9 0.197 to 0.354 (Convergent point 6 0.236)	5.5 to 8 0.217 to 0.315 (Convergent point 6 0.236)	5 to 9 0.197 to 0.354 (Convergent point 6 0.236)	5.5 to 8 0.217 to 0.315 (Convergent point 6 0.236)	—	4.5 to 9.5 0.177 to 0.374 (Convergent point 6 0.236)	—	—	P.104
FD-L41	—	—	—	—	—	—	—	—	—	P.104
FD-L43	—	—	—	—	—	—	—	—	—	P.104
FD-L44	0 to 5.7 0 to 0.224	1 to 4.5 0.039 to 0.177	1.5 to 3.8 0.059 to 0.150	1 to 4.6 0.039 to 0.181	2.5 to 3 0.098 to 0.118	—	1 to 4.3 0.039 to 0.169	—	—	P.104
FD-L44S	0 to 3.5 0 to 0.138	1 to 3 0.039 to 0.118	—	1 to 3 0.039 to 0.118	—	—	1 to 4.3 0.039 to 0.169	—	—	P.104
FD-L45	—	—	—	—	—	—	—	—	—	P.104
FD-L45A	—	—	—	—	—	—	—	—	—	P.105
FD-L46	—	—	—	—	—	—	—	—	—	P.105
FD-L47	—	—	—	—	—	—	—	—	—	P.105
FD-NFM2	16 0.630	8 0.315	5 0.197	8 0.315	4 0.157	2 0.079	6 0.236	3 0.118	2 0.079	P.105
FD-NFM2S	16 0.630	8 0.315	5 0.197	8 0.315	4 0.157	2 0.079	6 0.236	3 0.118	2 0.079	P.105
FD-NFM2S4	16 0.630	8 0.315	5 0.197	8 0.315	4 0.157	2 0.079	6 0.236	3 0.118	2 0.079	P.105
FD-P2	8 0.315	4 0.157	2.5 0.098	4 0.157	2 0.079	1.5 0.059	7 0.276	3.5 0.138	2 0.079	P.105
FD-P40	5 0.197	2.5 0.098	1.5 0.059	3 0.118	1.5 0.059	1 0.039	2 0.079	1 0.039	—	P.105
FD-P50	20 0.787	10 0.394	6 0.236	10 0.394	5 0.197	3 0.118	8 0.315	4 0.157	2.5 0.098	P.105
FD-P60	20 0.787	10 0.394	6 0.236	10 0.394	5 0.197	3 0.118	8 0.315	4 0.157	2.5 0.098	P.105
FD-P80	40 1.575	20 0.787	13 0.512	20 0.787	10 0.394	7 0.276	18 0.709	9 0.354	6 0.236	P.105
FD-P81X	32 1.260	16 0.630	10 0.394	16 0.630	8 0.315	5 0.197	18 0.709	9 0.354	6 0.236	P.106
FD-R80	32 1.260	16 0.630	10 0.394	16 0.630	8 0.315	5 0.197	10 0.394	5 0.197	3 0.118	P.106
FD-S30	19 0.749	9 0.354	6 0.236	9 0.354	4.5 0.177	2.5 0.098	8 0.315	4 0.157	2.5 0.098	P.106
FD-S31	18 0.709	8 0.315	5 0.197	8 0.315	4 0.157	2 0.079	7 0.276	3 0.118	2 0.079	P.106
FD-S80	46 1.811	23 0.906	15 0.591	24 0.945	12 0.472	8 0.315	20 0.787	10 0.394	7 0.276	P.106
FD-SFM2SV2	14 0.551	7 0.276	4 0.157	7 0.276	3.5 0.138	—	4 0.157	—	—	P.106
FD-SNFM2	16 0.630	8 0.315	5 0.197	8 0.315	4 0.157	2 0.079	6 0.236	3 0.118	2 0.079	P.106
FD-T40	16 0.630	8 0.315	5 0.197	8 0.315	4 0.157	2 0.079	6 0.236	3 0.118	2 0.079	P.106
FD-T80	46 1.811	23 0.906	15 0.591	24 0.945	12 0.472	8 0.315	20 0.787	10 0.394	7 0.276	P.106
FD-V41	6 0.236	3 0.118	—	3 0.118	—	—	—	—	—	P.106
FD-W8	23 0.906	11 0.433	8 0.315	14 0.551	7 0.276	4 0.157	11 0.433	5.5 0.217	3 0.118	P.107
FD-W44	5 0.197	2.5 0.098	1.5 0.059	3 0.118	1.5 0.059	1 0.039	2 0.079	1 0.039	—	P.107
FD-WG4	11 0.433	5 0.197	3 0.118	6 0.236	3 0.118	2 0.079	5 0.197	2.5 0.098	1.5 0.059	P.107
FD-WKZ1	—	—	—	—	—	—	—	—	—	P.107
FD-WL41	—	—	—	—	—	—	—	—	—	P.107
FD-WL48	—	—	—	—	—	—	0.5 to 3.5 0.020 to 0.138	—	—	P.107
FD-WS8	23 0.906	11 0.433	8 0.315	14 0.551	7 0.276	4 0.157	11 0.433	5.5 0.217	3 0.118	P.107
FD-WSG4	11 0.433	5 0.197	3 0.118	6 0.236	3 0.118	2 0.079	5 0.197	2.5 0.098	1.5 0.059	P.107
FD-WT4	5 0.197	2.5 0.098	1.5 0.059	3 0.118	1.5 0.059	1 0.039	2 0.079	1 0.039	—	P.107
FD-WT8	23 0.906	11 0.433	8 0.315	14 0.551	7 0.276	4 0.157	11 0.433	5.5 0.217	3 0.118	P.107
FD-WV42	—	—	—	—	—	—	—	—	—	P.108
FD-WZ4	—	—	—	—	—	—	5 to 8 0.197 to 0.315	—	—	P.108
FD-WZ4HB	4 to 9 0.157 to 0.354	—	—	—	—	—	4 to 12 0.157 to 0.472	—	—	P.108
FD-WZ7	4 to 15 0.157 to 0.591	—	—	—	—	—	5 to 8 0.197 to 0.315	—	—	P.108
FD-WZ7HB	3 to 28 0.118 to 1.102	3 to 14 0.118 to 0.551	4 to 8.4 0.157 to 0.331	3 to 16 0.118 to 0.630	4 to 8 0.157 to 0.315	4.8 0.189	3 to 18 0.118 to 0.709	—	—	P.108

Notes: 1) The standard sensing objects of the sensing ranges vary depending on the fibers.  
 2) Note that the sensing range of the free-cut type fiber may be reduced by 20 % max. depending upon how the fiber is cut.  
 3) Sold as a set comprising vacuum type fiber + photo-terminal (FV-BR1) + fiber at atmospheric side (FT-J8).

FIBER SENSORS

LASER SENSORS

PHOTO-ELECTRIC SENSORS

MICRO PHOTO-ELECTRIC SENSORS

AREA SENSORS

LIGHT CURTAINS

PRESSURE / FLOW SENSORS

INDUCTIVE PROXIMITY SENSORS

PARTICULAR USE SENSORS

SENSOR OPTIONS

SMILE WIRE-SAVING UNITS

WIRE-SAVING SYSTEMS

MEASUREMENT SENSORS

STATIC CONTROL DEVICES

ENDOSCOPE

LASER MARKERS

PLC / TERMINALS

HUMAN MACHINE INTERFACES

ENERGY CONSUMPTION VISUALIZATION COMPONENTS

FA COMPONENTS

MACHINE VISION SYSTEMS

UV CURING SYSTEMS

Selection Guide

Fibers

Amplifiers

FX-500

FX-100

FX-300



FX-410

FX-311

FX-301-F7/ FX-301-F

**FIBER OPTIONS**

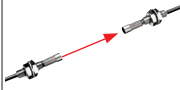
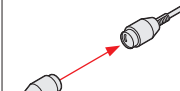
**Lens (for thru-beam type fiber)**

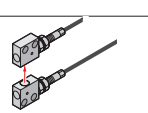
Designation	Model No.	Description																																																																																																	
For thru-beam type fiber	Expansion lens (Note 1) <b>FX-LE1</b>	 <p>Increases the sensing range by 5 times or more.</p> <ul style="list-style-type: none"> <li>Ambient temperature: <math>-60</math> to <math>+350</math> °C <math>-76</math> to <math>+662</math> °F (Note 5)</li> </ul>	<p><b>Sensing range for red LED type (mm) [Lens on both sides] (Note 3)</b></p> <table border="1"> <thead> <tr> <th>Fiber \ Mode</th> <th>U-LG</th> <th>LONG</th> <th>STDF</th> <th>STD</th> <th>FAST</th> <th>S-D</th> <th>H-SP</th> </tr> </thead> <tbody> <tr><td><b>FT-B8</b></td><td>3,500 (Note 2)</td><td>3,500 (Note 2)</td><td>3,000</td><td>2,500</td><td>2,000</td><td>1,000</td><td>1,000</td></tr> <tr><td><b>FT-FM2</b></td><td>3,500 (Note 2)</td><td>3,500 (Note 2)</td><td>3,500 (Note 2)</td><td>3,500 (Note 2)</td><td>2,500</td><td>1,300</td><td>1,000</td></tr> <tr><td><b>FT-T80</b></td><td>3,500 (Note 2)</td><td>3,500 (Note 2)</td><td>3,500 (Note 2)</td><td>3,500 (Note 2)</td><td>2,500</td><td>1,300</td><td>1,000</td></tr> <tr><td><b>FT-R80</b></td><td>3,500 (Note 2)</td><td>3,500 (Note 2)</td><td>3,500 (Note 2)</td><td>2,300</td><td>1,600</td><td>800</td><td>750</td></tr> <tr><td><b>FT-W8</b></td><td>3,500 (Note 2)</td><td>3,500 (Note 2)</td><td>3,500 (Note 2)</td><td>2,900</td><td>2,000</td><td>1,000</td><td>900</td></tr> <tr><td><b>FT-P80</b></td><td>3,500 (Note 2)</td><td>3,500 (Note 2)</td><td>3,500 (Note 2)</td><td>3,500 (Note 2)</td><td>2,500</td><td>1,100</td><td>1,000</td></tr> <tr><td><b>FT-P60</b></td><td>3,500 (Note 2)</td><td>3,500 (Note 2)</td><td>3,500 (Note 2)</td><td>3,500 (Note 2)</td><td>1,500</td><td>900</td><td>800</td></tr> <tr><td><b>FT-P81X</b></td><td>1,600 (Note 2)</td><td>1,600 (Note 2)</td><td>1,600 (Note 2)</td><td>1,600 (Note 2)</td><td>1,600 (Note 2)</td><td>1,100</td><td>950</td></tr> <tr><td><b>FT-H35-M2</b></td><td>3,500 (Note 2)</td><td>3,500 (Note 2)</td><td>2,500</td><td>2,000</td><td>1,500</td><td>750</td><td>700</td></tr> <tr><td><b>FT-H20W-M1</b></td><td>1,600 (Note 2)</td><td>1,600 (Note 2)</td><td>1,600 (Note 2)</td><td>1,300</td><td>900</td><td>500</td><td>400</td></tr> <tr><td><b>FT-H20-M1</b></td><td>1,600 (Note 2)</td><td>1,600 (Note 2)</td><td>1,600 (Note 2)</td><td>1,600 (Note 2)</td><td>1,100</td><td>900</td><td>600</td></tr> </tbody> </table>	Fiber \ Mode	U-LG	LONG	STDF	STD	FAST	S-D	H-SP	<b>FT-B8</b>	3,500 (Note 2)	3,500 (Note 2)	3,000	2,500	2,000	1,000	1,000	<b>FT-FM2</b>	3,500 (Note 2)	3,500 (Note 2)	3,500 (Note 2)	3,500 (Note 2)	2,500	1,300	1,000	<b>FT-T80</b>	3,500 (Note 2)	3,500 (Note 2)	3,500 (Note 2)	3,500 (Note 2)	2,500	1,300	1,000	<b>FT-R80</b>	3,500 (Note 2)	3,500 (Note 2)	3,500 (Note 2)	2,300	1,600	800	750	<b>FT-W8</b>	3,500 (Note 2)	3,500 (Note 2)	3,500 (Note 2)	2,900	2,000	1,000	900	<b>FT-P80</b>	3,500 (Note 2)	3,500 (Note 2)	3,500 (Note 2)	3,500 (Note 2)	2,500	1,100	1,000	<b>FT-P60</b>	3,500 (Note 2)	3,500 (Note 2)	3,500 (Note 2)	3,500 (Note 2)	1,500	900	800	<b>FT-P81X</b>	1,600 (Note 2)	1,600 (Note 2)	1,600 (Note 2)	1,600 (Note 2)	1,600 (Note 2)	1,100	950	<b>FT-H35-M2</b>	3,500 (Note 2)	3,500 (Note 2)	2,500	2,000	1,500	750	700	<b>FT-H20W-M1</b>	1,600 (Note 2)	1,600 (Note 2)	1,600 (Note 2)	1,300	900	500	400	<b>FT-H20-M1</b>	1,600 (Note 2)	1,600 (Note 2)	1,600 (Note 2)	1,600 (Note 2)	1,100	900	600
			Fiber \ Mode	U-LG	LONG	STDF	STD	FAST	S-D	H-SP																																																																																									
			<b>FT-B8</b>	3,500 (Note 2)	3,500 (Note 2)	3,000	2,500	2,000	1,000	1,000																																																																																									
			<b>FT-FM2</b>	3,500 (Note 2)	3,500 (Note 2)	3,500 (Note 2)	3,500 (Note 2)	2,500	1,300	1,000																																																																																									
<b>FT-T80</b>	3,500 (Note 2)	3,500 (Note 2)	3,500 (Note 2)	3,500 (Note 2)	2,500	1,300	1,000																																																																																												
<b>FT-R80</b>	3,500 (Note 2)	3,500 (Note 2)	3,500 (Note 2)	2,300	1,600	800	750																																																																																												
<b>FT-W8</b>	3,500 (Note 2)	3,500 (Note 2)	3,500 (Note 2)	2,900	2,000	1,000	900																																																																																												
<b>FT-P80</b>	3,500 (Note 2)	3,500 (Note 2)	3,500 (Note 2)	3,500 (Note 2)	2,500	1,100	1,000																																																																																												
<b>FT-P60</b>	3,500 (Note 2)	3,500 (Note 2)	3,500 (Note 2)	3,500 (Note 2)	1,500	900	800																																																																																												
<b>FT-P81X</b>	1,600 (Note 2)	1,600 (Note 2)	1,600 (Note 2)	1,600 (Note 2)	1,600 (Note 2)	1,100	950																																																																																												
<b>FT-H35-M2</b>	3,500 (Note 2)	3,500 (Note 2)	2,500	2,000	1,500	750	700																																																																																												
<b>FT-H20W-M1</b>	1,600 (Note 2)	1,600 (Note 2)	1,600 (Note 2)	1,300	900	500	400																																																																																												
<b>FT-H20-M1</b>	1,600 (Note 2)	1,600 (Note 2)	1,600 (Note 2)	1,600 (Note 2)	1,100	900	600																																																																																												
Super-expansion lens (Note 1) <b>FX-LE2</b>	 <p>Tremendously increases the sensing range with large diameter lenses.</p> <ul style="list-style-type: none"> <li>Ambient temperature: <math>-60</math> to <math>+350</math> °C <math>-76</math> to <math>+662</math> °F (Note 5)</li> </ul>	<p><b>Sensing range for red LED type (mm) [Lens on both sides] (Note 3)</b></p> <table border="1"> <thead> <tr> <th>Fiber \ Mode</th> <th>U-LG</th> <th>LONG</th> <th>STDF</th> <th>STD</th> <th>FAST</th> <th>S-D</th> <th>H-SP</th> </tr> </thead> <tbody> <tr><td><b>FT-B8</b></td><td>3,500 (Note 2)</td><td>3,500 (Note 2)</td><td>3,500 (Note 2)</td><td>3,500 (Note 2)</td><td>3,500 (Note 2)</td><td>3,500 (Note 2)</td><td>3,500 (Note 2)</td></tr> <tr><td><b>FT-FM2</b></td><td>3,500 (Note 2)</td><td>3,500 (Note 2)</td><td>3,500 (Note 2)</td><td>3,500 (Note 2)</td><td>3,500 (Note 2)</td><td>3,500 (Note 2)</td><td>3,500 (Note 2)</td></tr> <tr><td><b>FT-R80</b></td><td>3,500 (Note 2)</td><td>3,500 (Note 2)</td><td>3,500 (Note 2)</td><td>3,500 (Note 2)</td><td>3,500 (Note 2)</td><td>3,500 (Note 2)</td><td>3,500 (Note 2)</td></tr> <tr><td><b>FT-W8</b></td><td>3,500 (Note 2)</td><td>3,500 (Note 2)</td><td>3,500 (Note 2)</td><td>3,500 (Note 2)</td><td>3,500 (Note 2)</td><td>3,500 (Note 2)</td><td>3,500 (Note 2)</td></tr> <tr><td><b>FT-P80</b></td><td>3,500 (Note 2)</td><td>3,500 (Note 2)</td><td>3,500 (Note 2)</td><td>3,500 (Note 2)</td><td>3,500 (Note 2)</td><td>3,500 (Note 2)</td><td>3,500 (Note 2)</td></tr> <tr><td><b>FT-P60</b></td><td>3,500 (Note 2)</td><td>3,500 (Note 2)</td><td>3,500 (Note 2)</td><td>3,500 (Note 2)</td><td>3,500 (Note 2)</td><td>3,500 (Note 2)</td><td>3,500 (Note 2)</td></tr> <tr><td><b>FT-P81X</b></td><td>1,600 (Note 2)</td><td>1,600 (Note 2)</td><td>1,600 (Note 2)</td><td>1,600 (Note 2)</td><td>1,600 (Note 2)</td><td>1,600 (Note 2)</td><td>1,600 (Note 2)</td></tr> <tr><td><b>FT-H35-M2</b></td><td>3,500 (Note 2)</td><td>3,500 (Note 2)</td><td>3,500 (Note 2)</td><td>3,500 (Note 2)</td><td>3,500 (Note 2)</td><td>3,500 (Note 2)</td><td>3,500 (Note 2)</td></tr> <tr><td><b>FT-H20W-M1</b></td><td>1,600 (Note 2)</td><td>1,600 (Note 2)</td><td>1,600 (Note 2)</td><td>1,600 (Note 2)</td><td>1,600 (Note 2)</td><td>1,500</td><td>1,600 (Note 2)</td></tr> <tr><td><b>FT-H20-M1</b></td><td>1,600 (Note 2)</td><td>1,600 (Note 2)</td><td>1,600 (Note 2)</td><td>1,600 (Note 2)</td><td>1,600 (Note 2)</td><td>1,600 (Note 2)</td><td>1,600 (Note 2)</td></tr> <tr><td><b>FT-H13-FM2</b></td><td>3,500 (Note 2)</td><td>3,500 (Note 2)</td><td>3,500 (Note 2)</td><td>3,500 (Note 2)</td><td>3,500 (Note 2)</td><td>3,500 (Note 2)</td><td>3,500 (Note 2)</td></tr> </tbody> </table>	Fiber \ Mode	U-LG	LONG	STDF	STD	FAST	S-D	H-SP	<b>FT-B8</b>	3,500 (Note 2)	3,500 (Note 2)	3,500 (Note 2)	3,500 (Note 2)	3,500 (Note 2)	3,500 (Note 2)	3,500 (Note 2)	<b>FT-FM2</b>	3,500 (Note 2)	3,500 (Note 2)	3,500 (Note 2)	3,500 (Note 2)	3,500 (Note 2)	3,500 (Note 2)	3,500 (Note 2)	<b>FT-R80</b>	3,500 (Note 2)	3,500 (Note 2)	3,500 (Note 2)	3,500 (Note 2)	3,500 (Note 2)	3,500 (Note 2)	3,500 (Note 2)	<b>FT-W8</b>	3,500 (Note 2)	3,500 (Note 2)	3,500 (Note 2)	3,500 (Note 2)	3,500 (Note 2)	3,500 (Note 2)	3,500 (Note 2)	<b>FT-P80</b>	3,500 (Note 2)	3,500 (Note 2)	3,500 (Note 2)	3,500 (Note 2)	3,500 (Note 2)	3,500 (Note 2)	3,500 (Note 2)	<b>FT-P60</b>	3,500 (Note 2)	3,500 (Note 2)	3,500 (Note 2)	3,500 (Note 2)	3,500 (Note 2)	3,500 (Note 2)	3,500 (Note 2)	<b>FT-P81X</b>	1,600 (Note 2)	1,600 (Note 2)	1,600 (Note 2)	1,600 (Note 2)	1,600 (Note 2)	1,600 (Note 2)	1,600 (Note 2)	<b>FT-H35-M2</b>	3,500 (Note 2)	3,500 (Note 2)	3,500 (Note 2)	3,500 (Note 2)	3,500 (Note 2)	3,500 (Note 2)	3,500 (Note 2)	<b>FT-H20W-M1</b>	1,600 (Note 2)	1,600 (Note 2)	1,600 (Note 2)	1,600 (Note 2)	1,600 (Note 2)	1,500	1,600 (Note 2)	<b>FT-H20-M1</b>	1,600 (Note 2)	1,600 (Note 2)	1,600 (Note 2)	1,600 (Note 2)	1,600 (Note 2)	1,600 (Note 2)	1,600 (Note 2)	<b>FT-H13-FM2</b>	3,500 (Note 2)	3,500 (Note 2)	3,500 (Note 2)	3,500 (Note 2)	3,500 (Note 2)	3,500 (Note 2)	3,500 (Note 2)	
		Fiber \ Mode	U-LG	LONG	STDF	STD	FAST	S-D	H-SP																																																																																										
		<b>FT-B8</b>	3,500 (Note 2)	3,500 (Note 2)	3,500 (Note 2)	3,500 (Note 2)	3,500 (Note 2)	3,500 (Note 2)	3,500 (Note 2)																																																																																										
		<b>FT-FM2</b>	3,500 (Note 2)	3,500 (Note 2)	3,500 (Note 2)	3,500 (Note 2)	3,500 (Note 2)	3,500 (Note 2)	3,500 (Note 2)																																																																																										
<b>FT-R80</b>	3,500 (Note 2)	3,500 (Note 2)	3,500 (Note 2)	3,500 (Note 2)	3,500 (Note 2)	3,500 (Note 2)	3,500 (Note 2)																																																																																												
<b>FT-W8</b>	3,500 (Note 2)	3,500 (Note 2)	3,500 (Note 2)	3,500 (Note 2)	3,500 (Note 2)	3,500 (Note 2)	3,500 (Note 2)																																																																																												
<b>FT-P80</b>	3,500 (Note 2)	3,500 (Note 2)	3,500 (Note 2)	3,500 (Note 2)	3,500 (Note 2)	3,500 (Note 2)	3,500 (Note 2)																																																																																												
<b>FT-P60</b>	3,500 (Note 2)	3,500 (Note 2)	3,500 (Note 2)	3,500 (Note 2)	3,500 (Note 2)	3,500 (Note 2)	3,500 (Note 2)																																																																																												
<b>FT-P81X</b>	1,600 (Note 2)	1,600 (Note 2)	1,600 (Note 2)	1,600 (Note 2)	1,600 (Note 2)	1,600 (Note 2)	1,600 (Note 2)																																																																																												
<b>FT-H35-M2</b>	3,500 (Note 2)	3,500 (Note 2)	3,500 (Note 2)	3,500 (Note 2)	3,500 (Note 2)	3,500 (Note 2)	3,500 (Note 2)																																																																																												
<b>FT-H20W-M1</b>	1,600 (Note 2)	1,600 (Note 2)	1,600 (Note 2)	1,600 (Note 2)	1,600 (Note 2)	1,500	1,600 (Note 2)																																																																																												
<b>FT-H20-M1</b>	1,600 (Note 2)	1,600 (Note 2)	1,600 (Note 2)	1,600 (Note 2)	1,600 (Note 2)	1,600 (Note 2)	1,600 (Note 2)																																																																																												
<b>FT-H13-FM2</b>	3,500 (Note 2)	3,500 (Note 2)	3,500 (Note 2)	3,500 (Note 2)	3,500 (Note 2)	3,500 (Note 2)	3,500 (Note 2)																																																																																												
Side-view lens <b>FX-SV1</b>	 <p>Beam axis is bent by 90°.</p> <ul style="list-style-type: none"> <li>Ambient temperature: <math>-60</math> to <math>+300</math> °C <math>-76</math> to <math>+572</math> °F (Note 5)</li> </ul>	<p><b>Sensing range for red LED type (mm) [Lens on both sides] (Note 3)</b></p> <table border="1"> <thead> <tr> <th>Fiber \ Mode</th> <th>U-LG</th> <th>LONG</th> <th>STDF</th> <th>STD</th> <th>FAST</th> <th>S-D</th> <th>H-SP</th> </tr> </thead> <tbody> <tr><td><b>FT-B8</b></td><td>1,450</td><td>1,100</td><td>660</td><td>530</td><td>400</td><td>186</td><td>180</td></tr> <tr><td><b>FT-FM2</b></td><td>1,800</td><td>1,200</td><td>810</td><td>600</td><td>440</td><td>210</td><td>210</td></tr> <tr><td><b>FT-T80</b></td><td>1,800</td><td>1,200</td><td>810</td><td>600</td><td>440</td><td>210</td><td>210</td></tr> <tr><td><b>FT-W8</b></td><td>1,300</td><td>900</td><td>600</td><td>450</td><td>330</td><td>160</td><td>160</td></tr> <tr><td><b>FT-P80</b></td><td>1,800</td><td>1,200</td><td>810</td><td>600</td><td>440</td><td>210</td><td>210</td></tr> <tr><td><b>FT-P60</b></td><td>850</td><td>650</td><td>400</td><td>300</td><td>200</td><td>130</td><td>120</td></tr> <tr><td><b>FT-P81X</b></td><td>1,800</td><td>1,200</td><td>810</td><td>600</td><td>440</td><td>200</td><td>200</td></tr> <tr><td><b>FT-H35-M2</b></td><td>840</td><td>550</td><td>370</td><td>280</td><td>200</td><td>90</td><td>90</td></tr> <tr><td><b>FT-H20W-M1</b></td><td>400</td><td>310</td><td>180</td><td>140</td><td>100</td><td>50</td><td>50</td></tr> <tr><td><b>FT-H20-M1</b></td><td>840</td><td>550</td><td>370</td><td>280</td><td>200</td><td>90</td><td>90</td></tr> </tbody> </table>	Fiber \ Mode	U-LG	LONG	STDF	STD	FAST	S-D	H-SP	<b>FT-B8</b>	1,450	1,100	660	530	400	186	180	<b>FT-FM2</b>	1,800	1,200	810	600	440	210	210	<b>FT-T80</b>	1,800	1,200	810	600	440	210	210	<b>FT-W8</b>	1,300	900	600	450	330	160	160	<b>FT-P80</b>	1,800	1,200	810	600	440	210	210	<b>FT-P60</b>	850	650	400	300	200	130	120	<b>FT-P81X</b>	1,800	1,200	810	600	440	200	200	<b>FT-H35-M2</b>	840	550	370	280	200	90	90	<b>FT-H20W-M1</b>	400	310	180	140	100	50	50	<b>FT-H20-M1</b>	840	550	370	280	200	90	90									
		Fiber \ Mode	U-LG	LONG	STDF	STD	FAST	S-D	H-SP																																																																																										
		<b>FT-B8</b>	1,450	1,100	660	530	400	186	180																																																																																										
		<b>FT-FM2</b>	1,800	1,200	810	600	440	210	210																																																																																										
<b>FT-T80</b>	1,800	1,200	810	600	440	210	210																																																																																												
<b>FT-W8</b>	1,300	900	600	450	330	160	160																																																																																												
<b>FT-P80</b>	1,800	1,200	810	600	440	210	210																																																																																												
<b>FT-P60</b>	850	650	400	300	200	130	120																																																																																												
<b>FT-P81X</b>	1,800	1,200	810	600	440	200	200																																																																																												
<b>FT-H35-M2</b>	840	550	370	280	200	90	90																																																																																												
<b>FT-H20W-M1</b>	400	310	180	140	100	50	50																																																																																												
<b>FT-H20-M1</b>	840	550	370	280	200	90	90																																																																																												
Expansion lens for vacuum fiber (Note 1) <b>FV-LE1</b>	 <p>Sensing range increases by 4 times or more.</p> <ul style="list-style-type: none"> <li>Ambient temperature: <math>-60</math> to <math>+350</math> °C <math>-76</math> to <math>+662</math> °F (Note 5)</li> </ul>	<p><b>Sensing range for red LED type (mm) [Lens on both sides] (Note 3, 4)</b></p> <table border="1"> <thead> <tr> <th>Fiber \ Mode</th> <th>U-LG</th> <th>LONG</th> <th>STDF</th> <th>STD</th> <th>FAST</th> <th>S-D</th> <th>H-SP</th> </tr> </thead> <tbody> <tr><td><b>FT-H30-M1V-S</b></td><td>1,600</td><td>1,200</td><td>650</td><td>450</td><td>300</td><td>150</td><td>200</td></tr> </tbody> </table>	Fiber \ Mode	U-LG	LONG	STDF	STD	FAST	S-D	H-SP	<b>FT-H30-M1V-S</b>	1,600	1,200	650	450	300	150	200																																																																																	
		Fiber \ Mode	U-LG	LONG	STDF	STD	FAST	S-D	H-SP																																																																																										
<b>FT-H30-M1V-S</b>	1,600	1,200	650	450	300	150	200																																																																																												
Vacuum resistant side-view lens (Note 1) <b>FV-SV2</b>	 <p>Beam axis is bent by 90°.</p> <ul style="list-style-type: none"> <li>Ambient temperature: <math>-60</math> to <math>+300</math> °C <math>-76</math> to <math>+572</math> °F (Note 5)</li> </ul>	<p><b>Sensing range for red LED type (mm) [Lens on both sides] (Note 3, 4)</b></p> <table border="1"> <thead> <tr> <th>Fiber \ Mode</th> <th>U-LG</th> <th>LONG</th> <th>STDF</th> <th>STD</th> <th>FAST</th> <th>S-D</th> <th>H-SP</th> </tr> </thead> <tbody> <tr><td><b>FT-H30-M1V-S</b></td><td>1,600</td><td>1,200</td><td>650</td><td>450</td><td>300</td><td>150</td><td>200</td></tr> </tbody> </table>	Fiber \ Mode	U-LG	LONG	STDF	STD	FAST	S-D	H-SP	<b>FT-H30-M1V-S</b>	1,600	1,200	650	450	300	150	200																																																																																	
Fiber \ Mode	U-LG	LONG	STDF	STD	FAST	S-D	H-SP																																																																																												
<b>FT-H30-M1V-S</b>	1,600	1,200	650	450	300	150	200																																																																																												

- Notes: 1) Be careful when installing the thru-beam type fiber equipped with the expansion lens, as the beam envelope becomes narrow and alignment is difficult. Especially when installing a fiber with many cores (sharp bending fibers and heat-resistant glass fiber), please be sure to use it only after you have adjusted it sufficiently.
- 2) The fiber cable length practically limits the sensing range to 3,500 mm **137.795 in** long (**FT-P81X**, **FT-H20W-M1** and **FT-H20-M1**: 1,600 mm **62.992 in**).
- 3) The sensing ranges are the values for red LED type amplifier. Please contact our office for details on sensing ranges for other types of amplifiers.
- 4) The fiber cable length for the **FT-H30-M1V-S** is 1 m **3.281 ft**. The sensing ranges in U-LG and LONG modes take into account the length of the **FT-J8** atmospheric side fiber.
- 5) Refer to p.76~ for the ambient temperatures of fibers to be used in combination.

- FIBER SENSORS
- LASER SENSORS
- PHOTO-ELECTRIC SENSORS
- MICRO PHOTO-ELECTRIC SENSORS
- AREA SENSORS
- LIGHT CURTAINS
- PRESSURE / FLOW SENSORS
- INDUCTIVE PROXIMITY SENSORS
- PARTICULAR USE SENSORS
- SENSOR OPTIONS
- SIMPLE WIRE-SAVING UNITS
- WIRE-SAVING SYSTEMS
- MEASUREMENT SENSORS
- STATIC CONTROL DEVICES
- ENDOSCOPE
- LASER MARKERS
- PLC / TERMINALS
- HUMAN MACHINE INTERFACES
- ENERGY CONSUMPTION VISUALIZATION COMPONENTS
- FA COMPONENTS
- MACHINE VISION SYSTEMS
- UV CURING SYSTEMS
- Selection Guide
- Fibers
- Amplifiers
- FX-500**
- FX-100**
- FX-300**
- FX-410**
- FX-311**
- FX-301-F7/ FX-301-F

**FIBER OPTIONS**

**Lens (for reflective type fiber)**

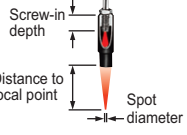
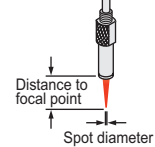
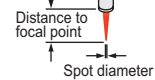
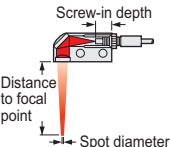
Designation	Model No.	Description															
For reflective type fiber	Pinpoint spot lens	<b>FX-MR1</b>	 <p>Pinpoint spot of <math>\phi 0.5</math> mm <math>\phi 0.020</math> in. Enables detection of minute objects or small marks.</p> <ul style="list-style-type: none"> <li>Distance to focal point: <math>6 \pm 1</math> mm <math>0.236 \pm 0.039</math> in</li> <li>Applicable fibers: <b>FD-WG4, FD-G4</b></li> <li>Ambient temperature: <math>-40</math> to <math>+70</math> °C <math>-40</math> to <math>+158</math> °F (Note 2)</li> </ul>														
	Zoom lens	<b>FX-MR2</b>	 <p>The spot diameter is adjustable from <math>\phi 0.7</math> to <math>\phi 2</math> mm <math>\phi 0.028</math> to <math>\phi 0.079</math> in according to how much the fiber is screwed in.</p> <ul style="list-style-type: none"> <li>Applicable fibers: <b>FD-WG4, FD-G4</b></li> <li>Ambient temperature: <math>-40</math> to <math>+70</math> °C <math>-40</math> to <math>+158</math> °F (Note 2)</li> <li>Accessory: <b>MS-EX-3</b> (mounting bracket)</li> </ul> <p><b>Sensing range for red LED type (Note 1)</b></p> <table border="1"> <thead> <tr> <th>Screw-in depth</th> <th>Distance to focal point</th> <th>Spot diameter</th> </tr> </thead> <tbody> <tr> <td>7 mm <math>0.276</math> in</td> <td><math>\phi 18.5</math> mm <math>\phi 0.728</math> in approx.</td> <td><math>\phi 0.7</math> mm <math>\phi 0.028</math> in</td> </tr> <tr> <td>12 mm <math>0.472</math> in</td> <td><math>\phi 27</math> mm <math>\phi 1.063</math> in approx.</td> <td><math>\phi 1.2</math> mm <math>\phi 0.047</math> in</td> </tr> <tr> <td>14 mm <math>0.551</math> in</td> <td><math>\phi 43</math> mm <math>\phi 1.693</math> in approx.</td> <td><math>\phi 2.0</math> mm <math>\phi 0.079</math> in</td> </tr> </tbody> </table>	Screw-in depth	Distance to focal point	Spot diameter	7 mm $0.276$ in	$\phi 18.5$ mm $\phi 0.728$ in approx.	$\phi 0.7$ mm $\phi 0.028$ in	12 mm $0.472$ in	$\phi 27$ mm $\phi 1.063$ in approx.	$\phi 1.2$ mm $\phi 0.047$ in	14 mm $0.551$ in	$\phi 43$ mm $\phi 1.693$ in approx.	$\phi 2.0$ mm $\phi 0.079$ in		
	Screw-in depth	Distance to focal point	Spot diameter														
	7 mm $0.276$ in	$\phi 18.5$ mm $\phi 0.728$ in approx.	$\phi 0.7$ mm $\phi 0.028$ in														
	12 mm $0.472$ in	$\phi 27$ mm $\phi 1.063$ in approx.	$\phi 1.2$ mm $\phi 0.047$ in														
14 mm $0.551$ in	$\phi 43$ mm $\phi 1.693$ in approx.	$\phi 2.0$ mm $\phi 0.079$ in															
Finest spot lens	<b>FX-MR3</b>	 <p>Extremely fine spot of <math>\phi 0.3</math> mm <math>\phi 0.012</math> in approx. achieved.</p> <ul style="list-style-type: none"> <li>Applicable fibers: <b>FD-WG4, FD-G4, FD-EG1, FD-EG2, FD-EG3, FD-G6X, FD-G6</b></li> <li>Ambient temperature: <math>-40</math> to <math>+70</math> °C <math>-40</math> to <math>+158</math> °F (Note 2)</li> </ul> <p><b>Sensing range for red LED type (Note 1)</b></p> <table border="1"> <thead> <tr> <th>Fiber</th> <th>Distance to focal point</th> <th>Spot diameter</th> </tr> </thead> <tbody> <tr> <td><b>FD-EG3</b></td> <td><math>7.5 \pm 0.5</math> mm <math>0.295 \pm 0.020</math> in</td> <td><math>\phi 0.15</math> mm <math>\phi 0.006</math> in approx</td> </tr> <tr> <td><b>FD-EG2</b></td> <td><math>7.5 \pm 0.5</math> mm <math>0.295 \pm 0.020</math> in</td> <td><math>\phi 0.2</math> mm <math>\phi 0.008</math> in approx</td> </tr> <tr> <td><b>FD-EG1</b></td> <td><math>7.5 \pm 0.5</math> mm <math>0.295 \pm 0.020</math> in</td> <td><math>\phi 0.3</math> mm <math>\phi 0.012</math> in approx</td> </tr> <tr> <td><b>FD-WG4/G4/G6X/G6</b></td> <td><math>7.5 \pm 0.5</math> mm <math>0.295 \pm 0.020</math> in</td> <td><math>\phi 0.5</math> mm <math>\phi 0.020</math> in approx</td> </tr> </tbody> </table>	Fiber	Distance to focal point	Spot diameter	<b>FD-EG3</b>	$7.5 \pm 0.5$ mm $0.295 \pm 0.020$ in	$\phi 0.15$ mm $\phi 0.006$ in approx	<b>FD-EG2</b>	$7.5 \pm 0.5$ mm $0.295 \pm 0.020$ in	$\phi 0.2$ mm $\phi 0.008$ in approx	<b>FD-EG1</b>	$7.5 \pm 0.5$ mm $0.295 \pm 0.020$ in	$\phi 0.3$ mm $\phi 0.012$ in approx	<b>FD-WG4/G4/G6X/G6</b>	$7.5 \pm 0.5$ mm $0.295 \pm 0.020$ in	$\phi 0.5$ mm $\phi 0.020$ in approx
Fiber	Distance to focal point	Spot diameter															
<b>FD-EG3</b>	$7.5 \pm 0.5$ mm $0.295 \pm 0.020$ in	$\phi 0.15$ mm $\phi 0.006$ in approx															
<b>FD-EG2</b>	$7.5 \pm 0.5$ mm $0.295 \pm 0.020$ in	$\phi 0.2$ mm $\phi 0.008$ in approx															
<b>FD-EG1</b>	$7.5 \pm 0.5$ mm $0.295 \pm 0.020$ in	$\phi 0.3$ mm $\phi 0.012$ in approx															
<b>FD-WG4/G4/G6X/G6</b>	$7.5 \pm 0.5$ mm $0.295 \pm 0.020$ in	$\phi 0.5$ mm $\phi 0.020$ in approx															
Finest spot lens	<b>FX-MR6</b>	 <p>Extremely fine spot of <math>\phi 0.1</math> mm <math>\phi 0.004</math> in approx. achieved.</p> <ul style="list-style-type: none"> <li>Applicable fibers: <b>FD-WG4, FD-G4, FD-EG1, FD-EG2, FD-EG3, FD-G6X, FD-G6</b></li> <li>Ambient temperature: <math>-20</math> to <math>+60</math> °C <math>-4</math> to <math>+140</math> °F (Note 2)</li> </ul> <p><b>Sensing range for red LED type (Note 1)</b></p> <table border="1"> <thead> <tr> <th>Fiber</th> <th>Distance to focal point</th> <th>Spot diameter</th> </tr> </thead> <tbody> <tr> <td><b>FD-EG3</b></td> <td><math>7 \pm 0.5</math> mm <math>0.276 \pm 0.020</math> in</td> <td><math>\phi 0.1</math> mm <math>\phi 0.004</math> in approx</td> </tr> <tr> <td><b>FD-EG2</b></td> <td><math>7 \pm 0.5</math> mm <math>0.276 \pm 0.020</math> in</td> <td><math>\phi 0.15</math> mm <math>\phi 0.006</math> in approx</td> </tr> <tr> <td><b>FD-EG1</b></td> <td><math>7 \pm 0.5</math> mm <math>0.276 \pm 0.020</math> in</td> <td><math>\phi 0.2</math> mm <math>\phi 0.008</math> in approx</td> </tr> <tr> <td><b>FD-WG4/G4/G6X/G6</b></td> <td><math>7 \pm 0.5</math> mm <math>0.276 \pm 0.020</math> in</td> <td><math>\phi 0.4</math> mm <math>\phi 0.016</math> in approx</td> </tr> </tbody> </table>	Fiber	Distance to focal point	Spot diameter	<b>FD-EG3</b>	$7 \pm 0.5$ mm $0.276 \pm 0.020$ in	$\phi 0.1$ mm $\phi 0.004$ in approx	<b>FD-EG2</b>	$7 \pm 0.5$ mm $0.276 \pm 0.020$ in	$\phi 0.15$ mm $\phi 0.006$ in approx	<b>FD-EG1</b>	$7 \pm 0.5$ mm $0.276 \pm 0.020$ in	$\phi 0.2$ mm $\phi 0.008$ in approx	<b>FD-WG4/G4/G6X/G6</b>	$7 \pm 0.5$ mm $0.276 \pm 0.020$ in	$\phi 0.4$ mm $\phi 0.016$ in approx
Fiber	Distance to focal point	Spot diameter															
<b>FD-EG3</b>	$7 \pm 0.5$ mm $0.276 \pm 0.020$ in	$\phi 0.1$ mm $\phi 0.004$ in approx															
<b>FD-EG2</b>	$7 \pm 0.5$ mm $0.276 \pm 0.020$ in	$\phi 0.15$ mm $\phi 0.006$ in approx															
<b>FD-EG1</b>	$7 \pm 0.5$ mm $0.276 \pm 0.020$ in	$\phi 0.2$ mm $\phi 0.008$ in approx															
<b>FD-WG4/G4/G6X/G6</b>	$7 \pm 0.5$ mm $0.276 \pm 0.020$ in	$\phi 0.4$ mm $\phi 0.016$ in approx															
Zoom lens (Side-view type)	<b>FX-MR5</b>	 <p><b>FX-MR2</b> is converted into a side-view type and can be mounted in a very small space.</p> <ul style="list-style-type: none"> <li>Applicable fibers: <b>FD-WG4, FD-G4</b></li> <li>Ambient temperature: <math>-40</math> to <math>+70</math> °C <math>-40</math> to <math>+158</math> °F (Note 2)</li> </ul> <p><b>Sensing range for red LED type (Note 1)</b></p> <table border="1"> <thead> <tr> <th>Screw-in depth</th> <th>Distance to focal point</th> <th>Spot diameter</th> </tr> </thead> <tbody> <tr> <td>8 mm <math>0.315</math> in</td> <td>13 mm <math>0.512</math> in approx.</td> <td><math>\phi 0.5</math> mm <math>\phi 0.020</math> in</td> </tr> <tr> <td>10 mm <math>0.394</math> in</td> <td>15 mm <math>0.591</math> in approx.</td> <td><math>\phi 0.8</math> mm <math>\phi 0.031</math> in</td> </tr> <tr> <td>14 mm <math>0.551</math> in</td> <td>30 mm <math>1.181</math> in approx.</td> <td><math>\phi 3.0</math> mm <math>\phi 0.118</math> in</td> </tr> </tbody> </table>	Screw-in depth	Distance to focal point	Spot diameter	8 mm $0.315$ in	13 mm $0.512$ in approx.	$\phi 0.5$ mm $\phi 0.020$ in	10 mm $0.394$ in	15 mm $0.591$ in approx.	$\phi 0.8$ mm $\phi 0.031$ in	14 mm $0.551$ in	30 mm $1.181$ in approx.	$\phi 3.0$ mm $\phi 0.118$ in			
Screw-in depth	Distance to focal point	Spot diameter															
8 mm $0.315$ in	13 mm $0.512$ in approx.	$\phi 0.5$ mm $\phi 0.020$ in															
10 mm $0.394$ in	15 mm $0.591$ in approx.	$\phi 0.8$ mm $\phi 0.031$ in															
14 mm $0.551$ in	30 mm $1.181$ in approx.	$\phi 3.0$ mm $\phi 0.118$ in															

Notes: 1) The sensing ranges are the values when used in combination with red LED type amplifier. Please contact our office for details on sensing ranges for other types of amplifier.  
 2) Refer p.76~ for the ambient temperatures of fibers to be used in combination.

**Others**

Designation	Model No.	Description		
Protective tube (For thru-beam type fiber)	<b>FTP-500</b> (0.5 m $1.641$ ft)	For M4 thread	<b>FT-42</b> <b>FT-FM2S4</b>	
	<b>FTP-1000</b> (1 m $3.281$ ft)		<b>FT-B8</b> <b>FT-H13-FM2</b>	
	<b>FTP-1500</b> (1.5 m $4.922$ ft)		<b>FT-FM2</b> <b>FT-P60</b>	
	Protective tube (For reflective type fiber)	<b>FTP-N500</b> (0.5 m $1.641$ ft)	For M3 thread	<b>FT-FM2S</b> <b>FT-P80</b>
		<b>FTP-N1000</b> (1 m $3.281$ ft)		<b>FT-31</b> <b>FT-P40</b>
<b>FTP-N1500</b> (1.5 m $4.922$ ft)		<b>FT-NFM2</b> <b>FT-T80</b>		
Protective tube (For reflective type fiber)	<b>FDP-500</b> (0.5 m $1.641$ ft)	For M6 thread	<b>FT-NFM2S</b> <b>FD-P40</b>	
	<b>FDP-1000</b> (1 m $3.281$ ft)		<b>FT-NFM2S4</b> <b>FD-T40</b>	
	<b>FDP-1500</b> (1.5 m $4.922$ ft)		<b>FD-61</b> <b>FD-FM2S4</b>	
	Fiber bender	<b>FDP-N500</b> (0.5 m $1.641$ ft)	For M4 thread	<b>FD-B8</b> <b>FD-H13-FM2</b>
		<b>FDP-N1000</b> (1 m $3.281$ ft)		<b>FD-FM2</b> <b>FD-P80</b>
<b>FDP-N1500</b> (1.5 m $4.922$ ft)		<b>FD-FM2S</b>		
Fiber bender	<b>FB-1</b>	The fiber bender bends the sleeve part of the fiber head at the proper radius. (Note 1)		
Universal sensor mounting stand (Note 2)	<b>MS-AJ1-F</b>	Horizontal mounting type		
	<b>MS-AJ2-F</b>	Vertical mounting type (For M3, M4 or M6 threaded head fiber)		
Single core holder	<b>FX-AT15A</b>	The incident light intensity may vary when using a multi-core fiber or a thin type sharp bending fiber. This holder suppresses the variation in the incident light intensity. Brown.		

Notes: 1) Do not bend the sleeve part of any side-view type fiber or ultra-small diameter head type fiber.  
 2) Refer to the universal sensor mounting stand **MS-AJ** series pages for details.

**Protective tube**

- FTP-□
- FDP-□



**Fiber bender**

- FB-1

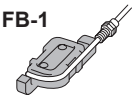

**Universal sensor mounting stand**

Using the arm which enables adjustment in the horizontal direction, sensing can also be done from above an assembly line.

- **MS-AJ1-F** Swivel: 360° rotation

Forward / back adjustment:  
130 mm  $5.118$  in approx

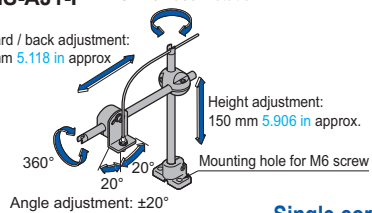

Angle adjustment:  $\pm 20^\circ$

**Single core holder**

- **MS-AJ2-F** Swivel: 360° rotation
- **FX-AT15A**

Forward / back adjustment:  
130 mm  $5.118$  in approx

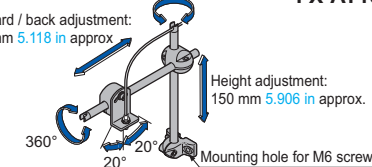

Angle adjustment:  $\pm 20^\circ$

FIBER SENSORS

LASER SENSORS

PHOTO-ELECTRIC SENSORS

MICRO PHOTO-ELECTRIC SENSORS

AREA SENSORS

LIGHT CURTAINS

PRESSURE / FLOW SENSORS

INDUCTIVE PROXIMITY SENSORS

PARTICULAR USE SENSORS

SENSOR OPTIONS

SIMPLE WIRE-SAVING UNITS

WIRE-SAVING SYSTEMS

MEASUREMENT SENSORS

STATIC CONTROL DEVICES

ENDOSCOPE

LASER MARKERS

PLC / TERMINALS

HUMAN MACHINE INTERFACES

ENERGY CONSUMPTION VISUALIZATION COMPONENTS

FA COMPONENTS

MACHINE VISION SYSTEMS

UV CURING SYSTEMS

Selection Guide

Fibers

Amplifiers

**FX-500**

**FX-100**

**FX-300**

**FX-410**

**FX-311**

**FX-301-F7/**  
**FX-301-F**



**SPECIFICATIONS**

FIBER SENSORS

LASER SENSORS

PHOTO-ELECTRIC SENSORS

MICRO PHOTO-ELECTRIC SENSORS

AREA SENSORS

LIGHT CURTAINS

PRESSURE / FLOW SENSORS

INDUCTIVE PROXIMITY SENSORS

PARTICULAR USE SENSORS

SENSOR OPTIONS

SIMPLE WIRE-SAVING UNITS

WIRE-SAVING SYSTEMS

MEASUREMENT SENSORS

STATIC CONTROL DEVICES

ENDOSCOPE

LASER MARKERS

PLC / TERMINALS

HUMAN MACHINE INTERFACES

ENERGY CONSUMPTION VISUALIZATION COMPONENTS

FA COMPONENTS

MACHINE VISION SYSTEMS

UV CURING SYSTEMS

Item	Type	Standard type				High-speed type	High-function type
		Red LED	Blue LED	Green LED	Infrared LED	FX-301-HS	FX-305
		FX-301	FX-301B	FX-301G	FX-301H		
	Mode No.	NPN output	FX-301P	FX-301BP	FX-301GP	FX-301HP	FX-305P
		PNP output	FX-301P	FX-301BP	FX-301GP	FX-301HP	FX-305P
Supply voltage		12 to 24 V DC ±10 %				Ripple P-P 10 % or less	
Power consumption		<Red LED / Infrared LED type> Normal operation: 960 mW or less (Current consumption 40 mA or less at 24 V supply voltage) ECO mode: 600 mW or less (Current consumption 25 mA or less at 24 V supply voltage)				<Blue LED / Green LED type> Normal operation: 720 mW or less (Current consumption 30 mA or less at 24 V supply voltage) ECO mode: 430 mW or less (Current consumption 18 mA or less at 24 V supply voltage)	
Output		<NPN output type> NPN open-collector transistor • Maximum sink current: 100 mA (50 mA, if five, or more, amplifiers are connected in cascade.) • Applied voltage: 30 V DC or less (between output and 0 V) • Residual voltage: 1.5 V or less [at 100 mA (at 50 mA, if five, or more, amplifiers are connected in cascade) sink current.]				<NPN output type> NPN open-collector transistor 2 outputs • Maximum sink current: 50 mA each (Note 2) • Applied voltage: 30 V DC or less (between output and 0 V) • Residual voltage: 1.5 V or less [at 50 mA (Note 2)]	
		<PNP output type> PNP open-collector transistor • Maximum source current: 100 mA (50 mA, if five, or more, amplifiers are connected in cascade.) • Applied voltage: 30 V DC or less (between output and +V) • Residual voltage: 1.5 V or less [at 100 mA (at 50 mA, if five, or more, amplifiers are connected in cascade) source current.]				<PNP output type> PNP open-collector transistor 2 outputs • Maximum source current: 50 mA each (Note 2) • Applied voltage: 30 V DC or less (between output and +V) • Residual voltage: 1.5 V or less [at 50 mA (Note 2)]	
	Output operation	Selectable either Light-ON or Dark-ON, with jog switch					
	Short-circuit protection	Incorporated					
Response time		65 μs or less [H-SP (Red LED type only)], 150 μs or less (FAST), 250 μs or less [STD / S-D (Red LED type only)], 2 ms or less (LONG), selectable with jog switch				35 μs or less (H-SP), 150 μs or less (FAST), 250 μs or less (STD / S-D), 2 ms or less (LONG), selectable with jog switch	
Sensitivity setting		2-point teaching / Limit teaching / Manual adjustment / Full-auto teaching / Max. sensitivity teaching				Normal mode: 2-point teaching / Limit teaching / Full-auto teaching / Max. sensitivity teaching / Manual adjustment Window comparator mode: Teaching (1-point / 2-point / 3-point) / Manual adjustment	
Operation indicator		Orange LED (lights up when the output is ON)					
Stability indicator		Green LED (lights up under stable light received condition or stable dark condition)				_____	
MODE indicator		RUN: Green LED, TEACH • ADJ • L/D ON • TIMER • PRO: Yellow LED					
Digital display		4 digit red LED display					
Fine sensitivity adjustment function		Incorporated					
Timer function		Incorporated with variable ON-delay / OFF-delay / ONE SHOT timer, switchable either effective or ineffective. [Timer period: Red LED type; 0.5 ms approx., 1 to 9999 ms (Blue LED, Green LED, Infrared LED type; approx. 0.5 to 500 ms)]				Incorporated with variable ON-delay / OFF-delay / ONE SHOT / ON-delay • OFF-delay / ON-delay • ONE SHOT timer, switchable either effective or ineffective. (Timer period: Output 1; 0.5 ms, 1 to 9999 ms, Output 2; 0.5 ms, 1 to 500 ms)	
Light emitting amount selection function		Incorporated (Red LED type only) (Note 3) FAST, STD, LONG: 4 level, H-SP: 3 level, S-D: 2 level				Incorporated (Note 3) FAST, STD, STDF, LONG, U-LG: 4 level H-SP: 3 level	
Automatic interference prevention function		Incorporated (Up to four sets of fiber heads can be mounted close together. However, H-SP mode is 2 fiber heads.) (Note 4)				_____	
Environmental resistance	Ambient temperature	-10 to +55 °C +14 to +131 °F (If 4 to 7 units are connected in cascade: -10 to +50 °C +14 to +122 °F, if 8 to 16 units are connected in cascade: -10 to +45 °C +14 to +113 °F) (No dew condensation or icing allowed), Storage: -20 to +70 °C -4 to +158 °F					
	Ambient humidity	35 to 85 % RH, Storage: 35 to 85 % RH					
	Ambient illuminance	Incandescent light: 3,000 lx at the light-receiving face					
	Voltage withstandability	1,000 V AC for one min. between all supply terminals connected together and enclosure (Note 6)					
	Insulation resistance	20 MΩ, or more, with 250 V DC megger between all supply terminals connected together and enclosure (Note 6)					
	Vibration resistance	10 to 150 Hz frequency, 0.75 mm 0.030 in amplitude in X, Y and Z directions for two hours each					
	Shock resistance	98 m/s <sup>2</sup> acceleration (10 G approx.) in X, Y and Z directions for five times each					
Emitting element (modulated)		Red LED	Blue LED	Green LED	Infrared LED	Red LED	Red LED
Peak emission wavelength		650 nm 0.026 mil	470 nm 0.019 mil	525 nm 0.021 mil	940 nm 0.037 mil	650 nm 0.026 mil	650 nm 0.026 mil
Material		Enclosure: Heat-resistant ABS, Case cover: Polycarbonate, MODE key: Acrylic, Jog switch: Heat-resistant ABS (FX-301B/G/H: Acrylic)					
Connecting method		Connector (Note 7)					
Cable length		Total length up to 100 m 328.084 ft (50 m 164.042 ft for 5 to 8 units, 20 m 65.617 ft for 9 to 16 units) is possible with 0.3 mm <sup>2</sup> , or more, cable.					
Weight		Net weight: 20 g approx., Gross weight: 25 g approx.					
Accessory		FX-MB1 (amplifier protection seal): 1 set				FX-MB1 (amplifier protection seal): 1 set	

Notes: 1) Where measurement conditions have not been specified precisely, the conditions used were an ambient temperature of +23 °C +73.4 °F.  
 2) 50 mA per output. 25 mA if five, or more, amplifiers are connected in cascade.  
 3) The light emitting amount can be zero (emission halt) in all modes.  
 4) When the power supply is switched on, the light emission timing is automatically set for interference prevention.  
 5) When the interference prevention function "P-2" is set, the number of mountable fiber heads becomes double.  
 Furthermore, take care that the response time also becomes double.  
 6) The voltage withstandability and the insulation resistance values given in the above table are for the amplifier only.  
 7) The cable for amplifier connection is not supplied as an accessory. Make sure to use the optional quick-connection cables given below.  
 Main cable (3-core) for FX-301(P)(-HS): CN-73-C1 (Cable length 1 m 3.281 ft), CN-73-C2 (Cable length 2 m 6.562 ft), CN-73-C5 (Cable length 5 m 16.404 ft)  
 Sub cable (1-core) for FX-301(P)(-HS): CN-71-C1 (Cable length 1 m 3.281 ft), CN-71-C2 (Cable length 2 m 6.562 ft), CN-71-C5 (Cable length 5 m 16.404 ft)  
 Main cable (4-core) for FX-305(P): CN-74-C1 (Cable length 1 m 3.281 ft), CN-74-C2 (Cable length 2 m 6.562 ft), CN-74-C5 (Cable length 5 m 16.404 ft)  
 Sub cable (2-core) for FX-305(P): CN-72-C1 (Cable length 1 m 3.281 ft), CN-72-C2 (Cable length 2 m 6.562 ft), CN-72-C5 (Cable length 5 m 16.404 ft)

## I/O CIRCUIT AND WIRING DIAGRAMS

### FX-301(-HS)

NPN output type

#### I/O circuit diagram

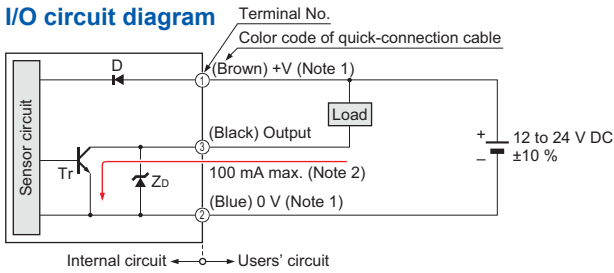

Notes: 1) The quick-connection sub cable does not have +V (brown) and 0 V (blue). The power is supplied from the connector of the main cable.  
2) 50 mA max., if five amplifiers, or more, are connected together.

Symbols ... D : Reverse supply polarity protection diode  
Zd : Surge absorption zener diode  
Tr : NPN output transistor

#### Wiring diagram

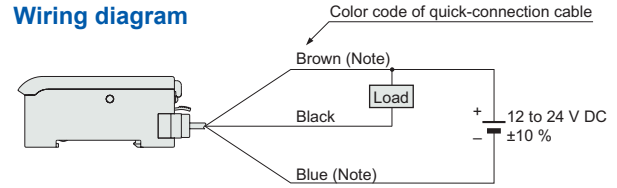

Note: The quick-connection sub cable does not have brown lead wire and blue lead wire.

#### Terminal arrangement diagram

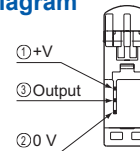

### FX-301P(-HS)

PNP output type

#### I/O circuit diagram

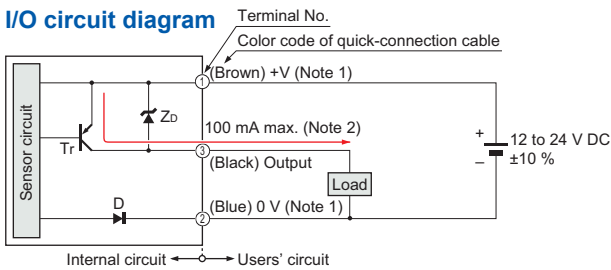

Notes: 1) The quick-connection sub cable does not have +V (brown) and 0 V (blue). The power is supplied from the connector of the main cable.  
2) 50 mA max., if five amplifiers, or more, are connected together.

Symbols ... D : Reverse supply polarity protection diode  
Zd : Surge absorption zener diode  
Tr : PNP output transistor

#### Wiring diagram

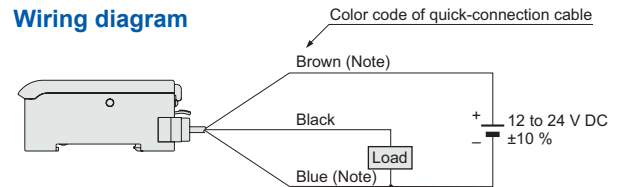

Note: The quick-connection sub cable does not have brown lead wire and blue lead wire.

#### Terminal arrangement diagram

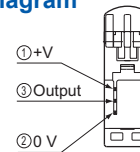

### FX-305

NPN output type

#### I/O circuit diagram

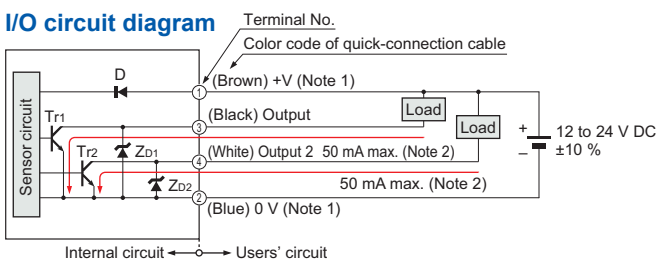

Notes: 1) The quick-connection sub cable does not have +V (brown) and 0 V (blue). The power is supplied from the connector of the main cable.  
2) 25 mA max., if five amplifiers, or more, are connected together.

Symbols ... D : Reverse supply polarity protection diode  
Zd1, Zd2 : Surge absorption zener diode  
Tr1, Tr2 : NPN output transistor

#### Wiring diagram

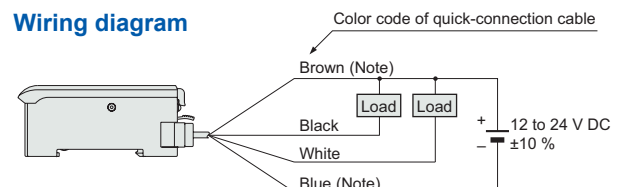

Note: The quick-connection sub cable does not have brown lead wire and blue lead wire.

#### Terminal arrangement diagram

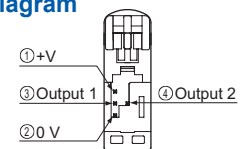

### FX-305P

PNP output type

#### I/O circuit diagram

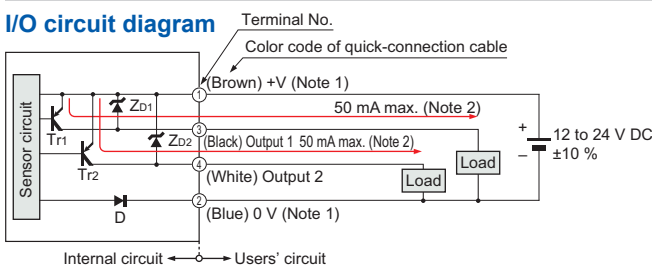

Notes: 1) The quick-connection sub cable does not have +V (brown) and 0 V (blue). The power is supplied from the connector of the main cable.  
2) 25 mA max., if five amplifiers, or more, are connected together.

Symbols ... D : Reverse supply polarity protection diode  
Zd1, Zd2 : Surge absorption zener diode  
Tr1, Tr2 : PNP output transistor

#### Wiring diagram

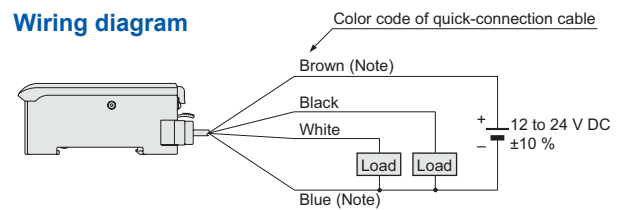

Note: The quick-connection sub cable does not have brown lead wire and blue lead wire.

#### Terminal arrangement diagram

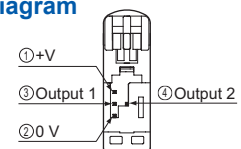

FIBER SENSORS

LASER SENSORS

PHOTO-ELECTRIC SENSORS

MICRO PHOTO-ELECTRIC SENSORS

AREA SENSORS

LIGHT CURTAINS

PRESSURE / FLOW SENSORS

INDUCTIVE PROXIMITY SENSORS

PARTICULAR USE SENSORS

SENSOR OPTIONS

SIMPLE WIRE-SAVING UNITS

WIRE-SAVING SYSTEMS

MEASUREMENT SENSORS

STATIC CONTROL DEVICES

ENDOSCOPE

LASER MARKERS

PLC / TERMINALS

HUMAN MACHINE INTERFACES

ENERGY CONSUMPTION VISUALIZATION COMPONENTS

FA COMPONENTS

MACHINE VISION SYSTEMS

UV CURING SYSTEMS

Selection Guide

Fibers

Amplifiers

FX-500

FX-100

FX-300

FX-410

FX-311

FX-301-F7/  
FX-301-F

**SENSING CHARACTERISTICS (TYPICAL)**

The following sensing characteristics pertain to the FX-300 red LED type. Please contact our office for the sensing characteristics pertaining corresponding to types other than the red LED or to types not mentioned here.

**Thru-beam type Parallel deviation**

Sensing characteristics are listed by model No. in alphabetical order. (However, models with the same sensing characteristics are listed together.)

**FT-A8 FT-WA8**

**Thru-beam type**

**Horizontal direction**

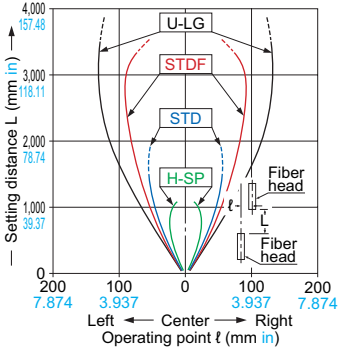

**Vertical direction**

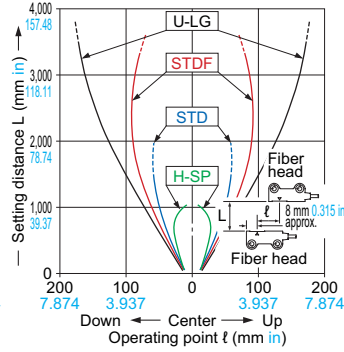

**FT-B8**

**Thru-beam type**

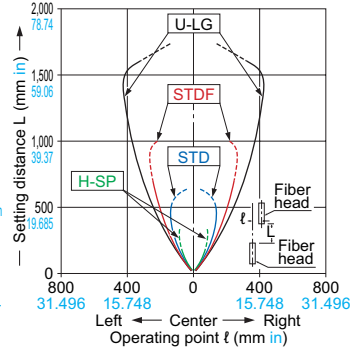

**FT-FM2 FT-FM2S FT-FM2S4 FT-SFM2 FT-T80**

**Thru-beam type**

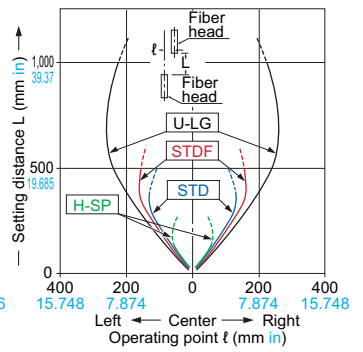

**FT-NFM2 FT-NFM2S FT-NFM2S4 FT-SNFM2**

**Thru-beam type**

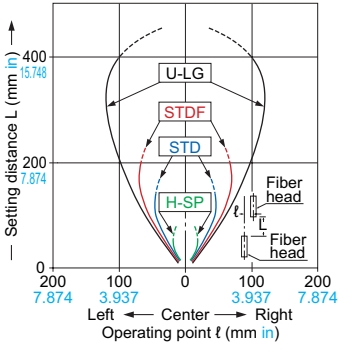

**FT-P81X**

**Thru-beam type**

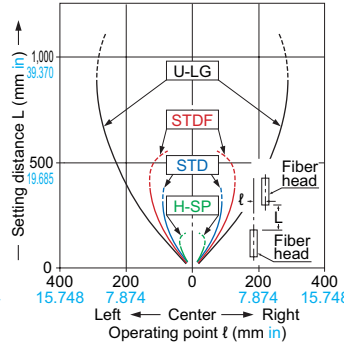

**FT-W4 FT-WS4**

**Thru-beam type**

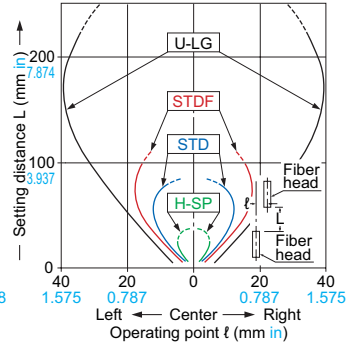

**FT-W8 FT-WS8**

**Thru-beam type**

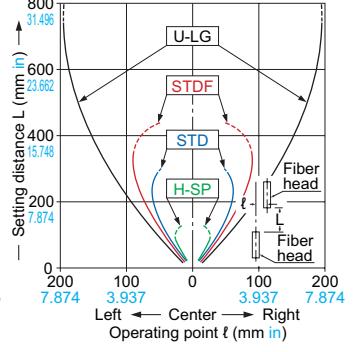

**Reflective type Sensing fields**

Sensing characteristics are listed by model No. in alphabetical order. (However, models with the same sensing characteristics are listed together.)

**FD-B8**

**Reflective type**

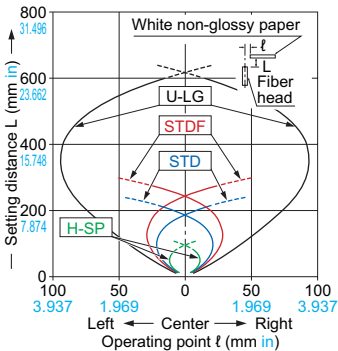

**FD-FM2**

**Reflective type**

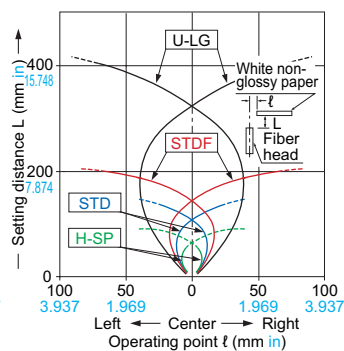

**FD-G4**

**Reflective type**

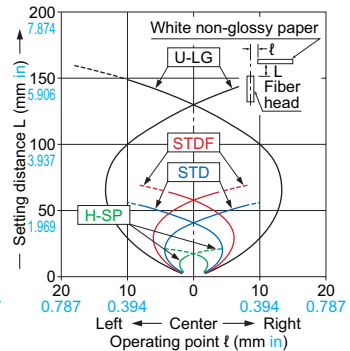

**FD-G6X**

**Reflective type**

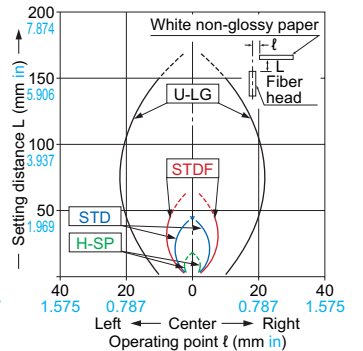

**FD-NFM2 FD-NFM2S FD-NFM2S4 FD-SNFM2 FT-T40**

**Reflective type**

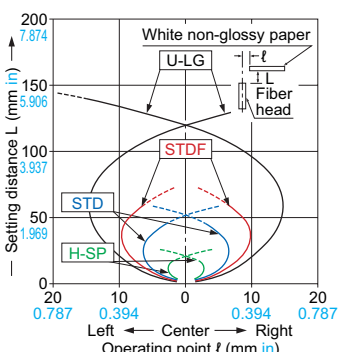

**FD-P81X**

**Reflective type**

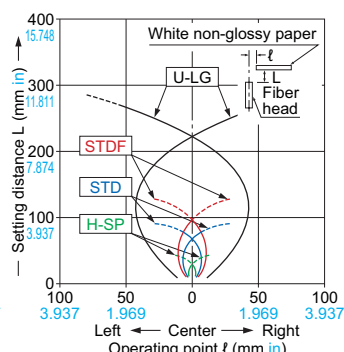

**FD-W8 FD-WS8 FD-WT8**

**Reflective type**

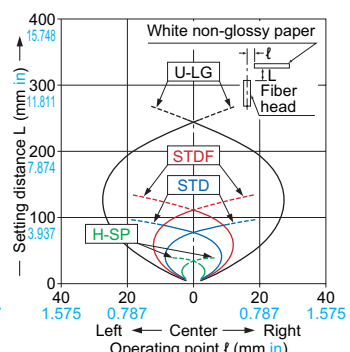

**FD-WG4 FD-WSG4**

**Reflective type**

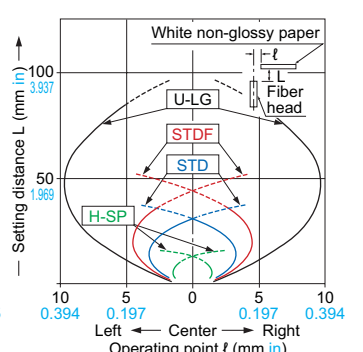

- FIBER SENSORS
- LASER SENSORS
- PHOTO-ELECTRIC SENSORS
- MICRO PHOTO-ELECTRIC SENSORS
- AREA SENSORS
- LIGHT CURTAINS
- PRESSURE / FLOW SENSORS
- INDUCTIVE PROXIMITY SENSORS
- PARTICULAR USE SENSORS
- SENSOR OPTIONS
- SIMPLE WIRE-SAVING UNITS
- WIRE-SAVING SYSTEMS
- MEASUREMENT SENSORS
- STATIC CONTROL DEVICES
- ENDOSCOPE
- LASER MARKERS
- PLC / TERMINALS
- HUMAN MACHINE INTERFACES
- ENERGY CONSUMPTION VISUALIZATION COMPONENTS
- FA COMPONENTS
- MACHINE VISION SYSTEMS
- UV CURING SYSTEMS
- Selection Guide
- Fibers
- Amplifiers
- FX-500
- FX-100
- FX-300
- FX-410
- FX-311
- FX-301-F7/ FX-301-F

## PRECAUTIONS FOR PROPER USE

Refer to General precautions, p.80~ for fiber precautions, and to the "PRO mode operation guide" on our website for details pertaining to operating instructions for the amplifier.



- Never use this product as a sensing device for personnel protection.
- In case of using sensing devices for personnel protection, use products which meet laws and standards, such as OSHA, ANSI or IEC etc., for personnel protection applicable in each region or country.

- The digital fiber sensor **FX-301(P)** has been modified since its production in June 2004. The explanations below are about the modified product.

### Mounting

#### How to mount the amplifier

- ① Fit the rear part of the mounting section of the amplifier on a 35 mm 1.378 in width DIN rail.
- ② Press down the rear part of the mounting section of the unit on the 35 mm 1.378 in width DIN rail and fit the front part of the mounting section to the 35 mm 1.378 in width DIN rail.

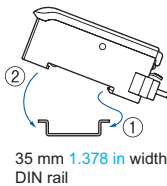

#### How to remove the amplifier

- ① Push the amplifier forward.
- ② Lift up the front part of the amplifier to remove it.

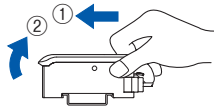

Note: Take care that if the front part is lifted without pushing the amplifier forward, the hook on the rear portion of the mounting section is likely to break.

#### Fiber installation

- Insert the fiber into the amplifier after attaching the attachment. Refer to the "Instruction Manual" included with the fiber for details.

- ① Push the fiber lock lever down.
- ② Slowly insert the fiber into the insertion slot until it stops. (Note 1)
- ③ Push the fiber lock lever back up until it stops.

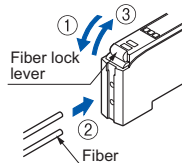

Notes: 1) Note that if the fiber is not fully inserted, the sensing distance will decrease. Also note that the flexible fiber may bend during insertion.  
2) In case of coaxial reflective type fibers (**FD-G4**, **FD-FM2**, etc.), mount the central fiber (single-core) to the emitter part and the peripheral fiber (multi-core) to the receiver. Note that sensing precision will deteriorate when done in reverse.

### Connection

- Make sure that the power supply is off while connecting or disconnecting the quick-connection cable.

#### Connection method

- ① Holding the connector of the quick-connection cable, align its projection with the groove at the top portion of the amplifier connector.
- ② Insert the connector till a click is felt.

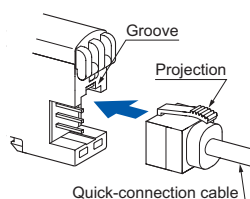

#### Disconnection method

- ① Pressing the projection at the top of the quick-connection cable, pull out the connector.

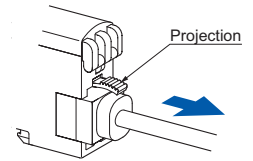

Note: Take care that if the connector is pulled out without pressing the projection, the projection may break. Do not use a quick-connection cable whose projection has broken. Further, do not pull by holding the cable, as this can cause a cable-break.

### Cascading

- Make sure that the power supply is off while adding or removing the amplifiers.
- Make sure to check the allowable ambient temperature, as it depends on the number of amplifiers connected in cascade.
- In case two, or more, amplifiers are connected in cascade, make sure to mount them on a DIN rail.
- When the amplifiers move on the DIN rail depending on the attaching condition or the amplifiers are mounted close to each other in cascade, fit them between the optional end plates (**MS-DIN-E**) mounted at the two ends.
- Up to maximum 15 amplifiers can be added (total 16 amplifiers connected in cascade.)
- When connecting more than two amplifiers in cascade, use the sub cable (**CN-71-C□** / **CN-72-C□**) as the quick-connection cable for the second amplifier onwards.
- When connecting amplifiers not close to each other in parallel, be sure to mount the optional end plate (**MS-DIN-E**) at both sides of each amplifier or affix the communication window seal of the accessory amplifier protection seal (**FX-MB1**) to the communication windows.
- The settings other than the interference prevention function cannot be transmitted between **FX-301(P)**, **FX-301B/G/H(P)**, **FX-305(P)**. Therefore, in case both models of amplifiers are mounted in cascade, be sure to mount identical models together. However, the interference prevention function is not incorporated in the **FX-301(P)-HS**. Take care when the sensors are mounted in cascade.
- If the **FX-301(P)** updated version unit or the **FX-305(P)** is mounted with the **FX-301(P)** previous version unit or the **FX-301B/G/H(P)** in cascade, place the **FX-301(P)** updated version units and the **FX-305(P)** units to the right side (seen from the connector side) of the previous version units. For details, refer to "**Cautions on sensor connection in cascade**".  
For a difference between the updated version unit and the previous version unit, refer to "**A difference between the updated version unit and the previous version unit**".
- The communication function of this product and that of the **FX-301(P)-F / F7** is different. If these models are mounted in cascade, affix the accessory fiber amplifier protection seal (**FX-MB1**) included in the **FX-301(P)** and **FX-305(P)** to the communication windows of the amplifiers.

FIBER SENSORS

LASER SENSORS

PHOTO-ELECTRIC SENSORS

MICRO PHOTO-ELECTRIC SENSORS

AREA SENSORS

LIGHT CURTAINS

PRESSURE / FLOW SENSORS

INDUCTIVE PROXIMITY SENSORS

PARTICULAR USE SENSORS

SENSOR OPTIONS

SIMPLE WIRE-SAVING UNITS

WIRE-SAVING SYSTEMS

MEASUREMENT SENSORS

STATIC CONTROL DEVICES

ENDOSCOPE

LASER MARKERS

PLC / TERMINALS

HUMAN MACHINE INTERFACES

ENERGY CONSUMPTION VISUALIZATION COMPONENTS

FA COMPONENTS

MACHINE VISION SYSTEMS

UV CURING SYSTEMS

Selection Guide

Fibers

Amplifiers

FX-500

FX-100

FX-300

FX-410

FX-311

FX-301-F7 / FX-301-F

**PRECAUTIONS FOR PROPER USE**

Refer to General precautions, p.80~ for fiber precautions, and to the "PRO mode operation guide" on our website for details pertaining to operating instructions for the amplifier.

**Cascading method**

- Mount the amplifiers, one by one, on the 35 mm 1.378 in width DIN rail.
- Slide the amplifiers next to each other, and connect the quick-connection cables.
- Mount the optional end plates (**MS-DIN-E**) at both the ends to hold the amplifiers between their flat sides.
- Tighten the screws to fix the end plates.

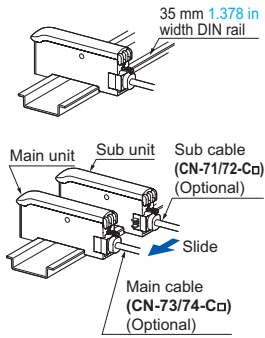

**Dismantling**

- Loosen the screws of the end plates.
- Remove the end plates.
- Slide the amplifiers and remove them one by one.

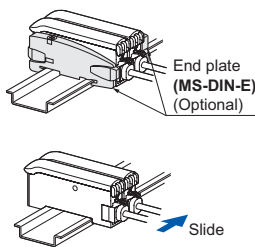

**Cautions on sensor connection in cascade**

- When the units in the group A and the group B shown in the table below are connected in cascade, connect them in cascade as **<Figure A>** shown below.

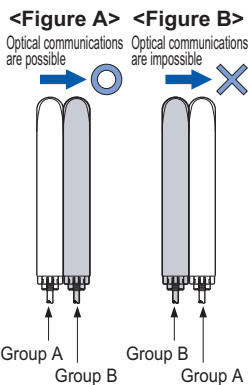

Group A	<b>FX-301(P)</b> : Previous version unit (Note 1), <b>FX-301G(P)/B(P)/H(P)</b> , <b>FX-41□(P)</b> , <b>LS-401(P)</b> (Note 2)
Group B	<b>FX-301(P)</b> : Updated version unit (Note 1), <b>FX-305(P)</b>

Notes: 1) For the difference between the updated version unit and the previous version unit, refer to "A difference between the updated version unit and the previous version unit".  
 2) When **LS-401(P)** is connected with the digital fiber amplifier in cascade, be sure to locate **LS-401(P)** at the left-most position (when viewed from the connector side).

- When the units of the group A and the group B are connected in cascade as **<Figure B>** shown above, optical communications cannot be done. When the optical communications function is used, connect them as **<Figure A>** shown above. If the units cannot be placed as **<Figure A>**, the following measure ① or ② should be taken.

- Affix the communication window seal of the accessory fiber amplifier protection seal (**FX-MB1**) to the communication window of the **FX-301(P)** updated version unit or **FX-305(P)**.
- If the measure ① described above cannot be taken, change the optical communications spec. of the group B units.

**How to change the communication specification of Group B**

- Change the communication specification of Group B according to the following procedures. Make sure to set the communication specification to "3" (Group A communication specification) or "0" (Optical Communication Stop).

**<Changing Procedure>**

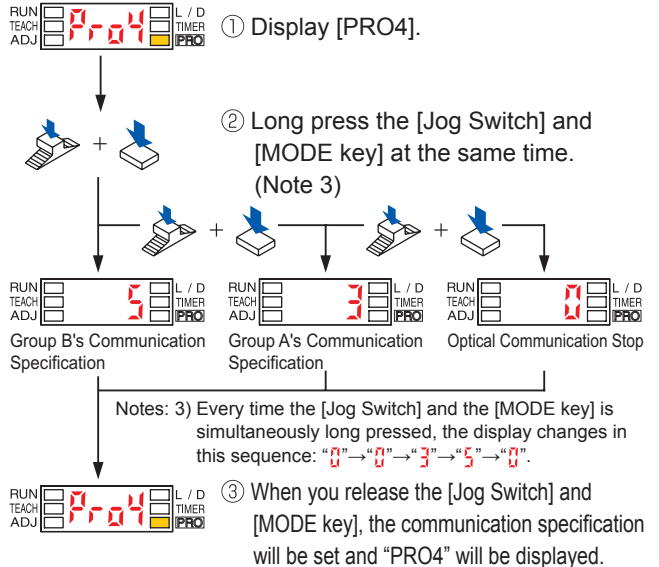

Notes: 3) Every time the [Jog Switch] and the [MODE key] is simultaneously long pressed, the display changes in this sequence: "0"→"3"→"5"→"0".  
 Notes: 4) When the communication specification is set to "3" (Group A communication specification)", make sure to tightly attach the products. Also make sure to take note of the following:  
 • There are instances when the optical communication function cannot be used due to the usage environment, etc.  
 • Do not perform batch channel loading or saving.

**Part description**

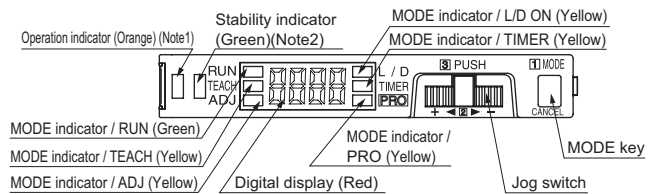

Notes: 1) **FX-305(P)**; Output 1 operation indicator (Orange)  
 2) **FX-305(P)**; Output 2 operation indicator (Orange)

**Operation procedure**

- When the power supply is switched on, communication self-check is carried out and normal condition is displayed [MODE indicator / RUN (green)] lights up and the digital display shows the incident light intensity.
- When the MODE key is pressed, the mode will change as shown in the following diagram.

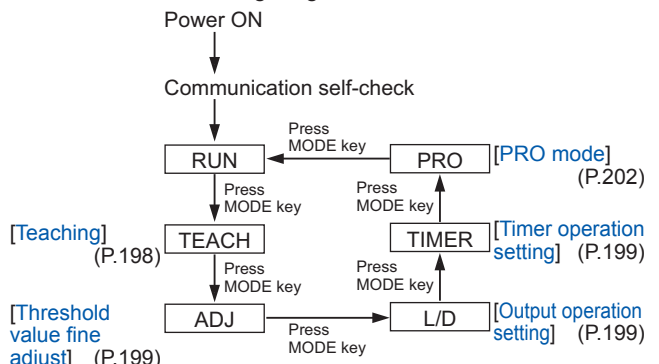

When Jog switch is pressed, the setting is confirmed.  
 When MODE key is pressed for 2 sec., or more, the sensor returns to the 'RUN' mode.  
 Cancellation is possible by pressing MODE key during setting.

- FIBER SENSORS
- LASER SENSORS
- PHOTO-ELECTRIC SENSORS
- MICRO PHOTO-ELECTRIC SENSORS
- AREA SENSORS
- LIGHT CURTAINS
- PRESSURE / FLOW SENSORS
- INDUCTIVE PROXIMITY SENSORS
- PARTICULAR USE SENSORS
- SENSOR OPTIONS
- SIMPLE WIRE-SAVING UNITS
- WIRE-SAVING SYSTEMS
- MEASUREMENT SENSORS
- STATIC CONTROL DEVICES
- ENDSCOPE
- LASER MARKERS
- PLC / TERMINALS
- HUMAN MACHINE INTERFACES
- ENERGY CONSUMPTION VISUALIZATION COMPONENTS
- FA COMPONENTS
- MACHINE VISION SYSTEMS
- UV CURING SYSTEMS

- Selection Guide
- Fibers
- Amplifiers
- FX-500
- FX-100
- FX-300
- FX-410
- FX-311
- FX-301-F7/ FX-301-F

**PRECAUTIONS FOR PROPER USE**

Refer to General precautions, p.80~ for fiber precautions, and to the "PRO mode operation guide" on our website for details pertaining to operating instructions for the amplifier.

**For FX-305(P)**









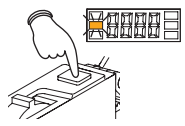

The **FX-305(P)** is equipped with two independent outputs, but the items that can be set in output 1 and output 2 respectively are only the following.  
 The items other than those are common.  
 ① Threshold value ② Output operation  
 ③ Timer operation and Timer period ④ Sensing mode

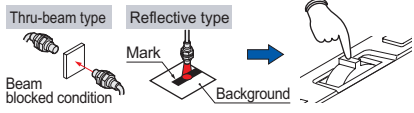
**Teaching**

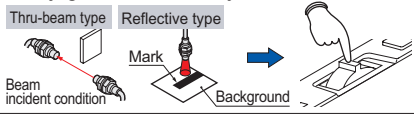
- The threshold values can be set by 2-point teaching, limit teaching, full-auto teaching or window comparator mode (1-point, 2-point, 3-point teaching) [only for **FX-305(P)**], when the MODE indicator / TEACH (yellow) lights up.

**In case of 2-point teaching**







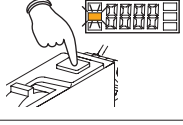

- This is the method of setting the threshold value by teaching two levels, corresponding to the object present and object absent conditions. Normally, setting is done by this method.

Step	Description	Display
①	Set the fiber within the sensing range. Press MODE key to light up MODE indicator / TEACH (yellow). 	
②	For <b>FX-305(P)</b> , select either Output 1 "Out 1" or Output 2 "Out 2" beforehand, press jog switch in the object present condition. If the teaching is accepted, the read incident light intensity blinks in the digital display. 	
③	MODE indicator / TEACH (yellow) blinks. Press jog switch in the object absent condition. 	
④	If the teaching is accepted, the read incident light intensity blinks in the digital display and the threshold value is set at the mid-value between the incident light intensities in the object present and the object absent conditions. After this, the judgment on the stability of sensing is displayed. • In case stable sensing is possible: "Good" is displayed. • In case stable sensing is not possible: "Bad" blinks.	 
⑤	The threshold value is displayed.	
⑥	"...." blinks in the digital display. (only <b>FX-301B/G/H</b> )	
⑦	The incident light intensity appears in the digital display and the setting is complete.	

- Notes: 1) Do not move or bend the fiber cable after the sensitivity setting. Detection may become unstable.  
 2) In case a reflective-type fiber is used, maximum sensitivity will be set if the jog switch is pushed while in no work status in procedure ② and ③.

**In case of full auto-teaching**

- Full auto-teaching is used when it is desired to set the threshold value without stopping the assembly line, with the object in the moving condition.

Step	Description	Display
①	Set the fiber within the sensing range. Press MODE key to light up MODE indicator / TEACH (yellow). 	
②	For <b>FX-305(P)</b> , select either Output 1 "Out 1" or Output 2 "Out 2" beforehand, press the jog switch continuously for 0.5 sec. or more with the object moving on the assembly line. (The incident light intensity is displayed during sampling.)	
③	"Auto" is displayed on the digital display. Release the jog switch when the object has passed.	
④	If the teaching is accepted, the read incident light intensity blinks in the digital display and the threshold value is set at the mid-value between the incident light intensities in the object present and the object absent conditions. After this, the judgment on the stability of sensing is displayed. • In case stable sensing is possible: "Good" is displayed. • In case stable sensing is not possible: "Bad" blinks.	 
⑤	The threshold value is displayed.	
⑥	"...." blinks in the digital display. (only <b>FX-301B/G/H</b> )	
⑦	The incident light intensity appears in the digital display and the setting is complete.	

- Notes: 1) The threshold value's shift amount can be selected in PRO mode. Refer to the "PRO Mode Operation Guide" for more details pertaining to setting instructions. (Increments of 5 % between -45 and 45 % for setting possible. 0 % default.)  
 2) Do not move or bend the fiber cable after the sensitivity setting. Detection may become unstable.

FIBER SENSORS

LASER SENSORS

PHOTO-ELECTRIC SENSORS

MICRO PHOTO-ELECTRIC SENSORS

AREA SENSORS

LIGHT CURTAINS

PRESSURE / FLOW SENSORS

INDUCTIVE PROXIMITY SENSORS

PARTICULAR USE SENSORS

SENSOR OPTIONS

SIMPLE WIRE-SAVING UNITS

WIRE-SAVING SYSTEMS

MEASUREMENT SENSORS

STATIC CONTROL DEVICES

ENDOSCOPE

LASER MARKERS

PLC / TERMINALS

HUMAN MACHINE INTERFACES

ENERGY CONSUMPTION VISUALIZATION COMPONENTS

FA COMPONENTS

MACHINE VISION SYSTEMS

UV CURING SYSTEMS

---

Selection Guide

Fibers

Amplifiers

---

**FX-500**

**FX-100**

**FX-300**

**FX-410**

**FX-311**

FX-301-F7/  
FX-301-F

FIBER SENSORS

LASER SENSORS

PHOTO-ELECTRIC SENSORS

MICRO PHOTO-ELECTRIC SENSORS

AREA SENSORS

LIGHT CURTAINS

PRESSURE / FLOW SENSORS

INDUCTIVE PROXIMITY SENSORS

PARTICULAR USE SENSORS

SENSOR OPTIONS

SIMPLE WIRE-SAVING UNITS

WIRE-SAVING SYSTEMS

MEASUREMENT SENSORS

STATIC CONTROL DEVICES

ENDOSCOPE

LASER MARKERS

PLC / TERMINALS

HUMAN MACHINE INTERFACES

ENERGY CONSUMPTION VISUALIZATION COMPONENTS

FA COMPONENTS

MACHINE VISION SYSTEMS

UV CURING SYSTEMS

---

Selection Guide

Fibers

Amplifiers

---

**FX-500**

**FX-100**

**FX-300**

**FX-410**

**FX-311**

FX-301-F7/  
FX-301-F

## PRECAUTIONS FOR PROPER USE

Refer to General precautions, p.80~ for fiber precautions, and to the "PRO mode operation guide" on our website for details pertaining to operating instructions for the amplifier.

### In case of limit teaching

- This is the method of setting the threshold value by teaching only the object absent condition (stable incident light condition). This is used for detection in the presence of a background body or for detection of small objects.

Step	Description	Display
①	Set the fiber within the sensing range. Press MODE key to light up MODE indicator / TEACH (yellow).	
②	For <b>FX-305(P)</b> , select either Output 1 "Out 1" or Output 2 "Out 2" beforehand, press jog switch in the object absent condition. If the teaching is accepted, the read incident light intensity blinks in the display. <b>Thru-beam type</b> <b>Reflective type</b> 	
③	MODE indicator / TEACH (yellow) blinks. Turn jog switch to the "+" side or "-" side.	
④	If jog switch is turned to the "+" side, " " scrolls (twice) the display from right to left (Note 1), and the threshold level is shifted to a value approx. 15 % higher (lower sensitivity) than that set at ②. (Note 2) This is used in case of reflective type fibers. If jog switch is turned to the "-" side, " " scrolls (twice) the display from left to right, and the threshold level is shifted to a value approx. 15 % lower (higher sensitivity) than that set at ②. (Note 2) This is used in case of thru-beam type fibers.  High Threshold value 100% 15% 15% Incident light intensity with object absent Threshold value Low 0 Turn to "+" side Turn to "-" side	
⑤	After this, the judgment on whether the setting shift amount can be shifted or not is displayed. • In case shifting is possible: "Good" blinks. • In case shifting is not possible: "ERR" blinks.	 
⑥	The threshold value is displayed.	
⑦	"....." blinks in the digital display. (only <b>FX-301B/G/H</b> )	
⑧	The incident light intensity appears in the digital display and the setting is complete.	

- Notes: 1) Scrolling display is not available in **FX-301B/G/H**.  
2) The approx. 15 % amount of shift is the initial value. The amount of shift can be changed in the PRO mode from approx. 5 to 80 % (5 % step). Refer to the "PRO Mode Operation Guide" for more details pertaining to setting instructions.  
3) Do not move or bend the fiber cable after the sensitivity setting. Detection may become unstable.

Please download the instruction manual from our website for setting of threshold value when used in combination with liquid level sensing fiber **FD-F8Y** and with pipe-mountable liquid level sensing fiber **FD-F4**.

For the wind comparator mode teaching in **FX-305(P)**, refer to the separately prepared "PRO Mode Operation Guide".

### Threshold value fine adjustment

Step	Description	Display
①	Press MODE key to light up MODE indicator / ADJ (yellow). 	
②	For <b>FX-305(P)</b> , select either Output 1 "Out 1" or Output 2 "Out 2" beforehand, in case the threshold value is to be increased (sensitivity to be reduced), turn the jog switch to the "+" side to increase the threshold value slowly. If the jog switch is turned continuously to the "+" side, the threshold value increases rapidly. In case the threshold value is to be decreased (sensitivity to be increased), turn the jog switch to the "-" side to decrease the threshold value slowly. If the jog switch is turned continuously to the "-" side, the threshold value decreases rapidly. 	 ↓  or  ↓ 
③	When jog switch is pressed, the threshold value is confirmed. 	

### Output operation setting

Step	Description	Display
①	Press MODE key to light up MODE indicator / L/D ON (yellow). 	 Displays present setting
②	For <b>FX-305(P)</b> , select either Output 1 "Out 1" or Output 2 "Out 2" beforehand, if the jog switch is turned to the "+" or "-" direction, the output operation setting will change. 	 ↓  ↑ Dark state
③	When jog switch is pressed, the threshold value is confirmed. 	 Displays selected setting

### Timer operation setting

- The setting for whether the timer is used or not can be done when MODE indicator / TIMER (yellow) lights up. For **FX-301B/G/H**, the timer type can be set in PRO mode.
- Further, an OFF-delay (initial value) which is useful when the response of the connected device is slow, etc., an ON-delay which is useful to detect only objects taking a long time to travel, and ONE SHOT, which is useful when the input specifications of the connected device require a signal of a fixed width, are possible with the **FX-301(-HS)**. **FX-305(P)** is also equipped with ON-delay • OFF-delay and ON-delay • ONE SHOT timers. Refer to the "PRO Mode Operation Guide" for the setting method of the OFF-delay, ON-delay and ONE SHOT timer intervals.

**PRECAUTIONS FOR PROPER USE**

Refer to General precautions, p.80~ for fiber precautions, and to the "PRO mode operation guide" on our website for details pertaining to operating instructions for the amplifier.

**Wiring**

- Make sure that the power supply is off while wiring.
- Verify that the supply voltage variation is within the rating.
- Take care that if a voltage exceeding the rated range is applied, or if an AC power supply is directly connected, the product may get burnt or damaged.
- If power is supplied from a commercial switching regulator, ensure that the frame ground (F.G.) terminal of the power supply is connected to an actual ground.
- In case noise generating equipment (switching regulator, inverter motor, etc.) is used in the vicinity of this product, connect the frame ground (F.G.) terminal of the equipment to an actual ground.
- Take care that short circuit of the load wrong wiring may burn or damage the product.
- Do not run the wires together with high-voltage lines or power lines or put them in the same raceway. This can cause malfunction due to induction.
- Make sure to use an isolation transformer for the DC power supply. If an autotransformer (single winding transformer) is used, this product or the power supply may get damaged.
- Make sure to use the optional quick-connection cable for the connection of the amplifier. Extension up to total 100 m **328.084 ft** is possible with 0.3 mm<sup>2</sup>, or more, cable. (5-8 unit expansion: 50 m **164.042 ft**, 9-16 unit expansion: 20 m **65.617 ft**) However, in order to reduce noise, make the wiring as short as possible.
- Note that the residual voltage will increase when the cable is extended.

**Key-lock function**

- If jog switch and MODE key are pressed for more than 2 sec. at the same time in 'RUN' mode condition, the key operations are locked, and only the threshold value confirmation function or the adjust function (valid only when the adjust lock function is canceled) is valid. To cancel the lock function, press both the keys for more than 2 sec. once again.  
Note: 3 seconds or more for **FX-301B/G/H(P)**.

**Others**

- When the emission halt of the light emitting amount selection function is set from "OFF" to "ON", the output may be unstable. Do not use the output control for 0.5 sec. after starting emission.
- Do not use during the initial transient time (0.5 sec.) after the power supply is switched on.
- Take care that the sensor is not directly exposed to fluorescent lamp from a rapid-starter lamp, a high frequency lighting device or sunlight etc. , as it may affect the sensing performance.
- Do not use this sensor in places having excessive vapor, dust, etc., or where it may come in contact with corrosive gas.
- Take care that the product does not come in direct contact with water, oil, grease, or organic solvents, such as, thinner, etc.
- This sensor cannot be used in an environment containing inflammable or explosive gases.
- Never disassemble or modify the sensor.

**Function table for FX-300 series**

	Previous models			New models		
	Standard type	High-function type	High-speed type	Standard type	High-speed type	High-function type
	<b>FX-301(P)</b> (Previous version unit)	<b>FX-302(P)</b>	<b>FX-303(P)</b>	<b>FX-301(P)</b> (Updated version unit)	<b>FX-301(P)-HS</b>	<b>FX-305(P)</b>
Four-chemical emitting element + APC circuit	No	No	No	Yes	Yes	Yes
Four-chemical emitting element only	Yes (Note)	Yes	Yes	————	————	————
Light emitting amount selection function	No	No	No	Yes	Yes	Yes
Reduced intensity mode (S-D)	Yes (Note)	Yes	No	Yes	Yes	————
9,999 digit display	No	No	No	No	No	Yes
Response time (Max. speed)	150 μs	300 μs	90 μs	65 μs	35 μs	65 μs
Interference prevention function (Effective no. of units)	Incorporated (4)	Incorporated (8)	Not incorporated (0)	Incorporated (4)	Not incorporated (0)	Incorporated (16)
Independent 2 outputs	No	No	No	No	No	Yes
Alarm output function	No	No	No	No	No	Yes
Error output function	No	No	No	No	No	Yes
Differential sensing	No	No	No	No	No	Yes
Window comparator mode	No	Yes	No	No	No	Yes

**Peripheral units that can be combined**

	Standard type	High-function type	High-speed type	Standard type	High-speed type	High-function type
Bank selection unit <b>FX-CH(-P)</b>	Yes	Yes	No	No	No	No
External input unit <b>FX-CH2(-P)</b>	No	No	No	Yes	No	Yes
Upper communication unit <b>SC-GU1-485</b>	No	No	No	Yes	No	Yes

Note: Except **FX-301B/G/H**.

- FIBER SENSORS
- LASER SENSORS
- PHOTO-ELECTRIC SENSORS
- MICRO PHOTO-ELECTRIC SENSORS
- AREA SENSORS
- LIGHT CURTAINS
- PRESSURE / FLOW SENSORS
- INDUCTIVE PROXIMITY SENSORS
- PARTICULAR USE SENSORS
- SENSOR OPTIONS
- SIMPLE WIRE-SAVING UNITS
- WIRE-SAVING SYSTEMS
- MEASUREMENT SENSORS
- STATIC CONTROL DEVICES
- ENDOSCOPE
- LASER MARKERS
- PLC / TERMINALS
- HUMAN MACHINE INTERFACES
- ENERGY CONSUMPTION VISUALIZATION COMPONENTS
- FA COMPONENTS
- MACHINE VISION SYSTEMS
- UV CURING SYSTEMS

- Selection Guide
- Fibers
- Amplifiers
- FX-500**
- FX-100**
- FX-300**
- FX-410**
- FX-311**
- FX-301-F7/ FX-301-F**



FIBER SENSORS  
 LASER SENSORS  
 PHOTO-ELECTRIC SENSORS  
 MICRO PHOTO-ELECTRIC SENSORS  
 AREA SENSORS  
 LIGHT CURTAINS  
 PRESSURE / FLOW SENSORS  
 INDUCTIVE PROXIMITY SENSORS  
 PARTICULAR USE SENSORS  
 SENSOR OPTIONS  
 SIMPLE WIRE-SAVING UNITS  
 WIRE-SAVING SYSTEMS  
 MEASUREMENT SENSORS  
 STATIC CONTROL DEVICES  
 ENDOSCOPE  
 LASER MARKERS  
 PLC / TERMINALS  
 HUMAN MACHINE INTERFACES  
 ENERGY CONSUMPTION VISUALIZATION COMPONENTS  
 FA COMPONENTS  
 MACHINE VISION SYSTEMS  
 UV CURING SYSTEMS  
 Selection Guide  
 Fibers  
 Amplifiers  
**FX-500**  
**FX-100**  
**FX-300**  
**FX-410**  
**FX-311**  
 FX-301-F7/  
 FX-301-F

**PRECAUTIONS FOR PROPER USE**

Refer to General precautions, p.80~ for fiber precautions, and to the "PRO mode operation guide" on our website for details pertaining to operating instructions for the amplifier.

**A difference between the updated version unit and the previous version unit for FX-301(P) (Red LED type)**

• The product has been modified as shown below since its production in June 2004.

**Changes in appearance**

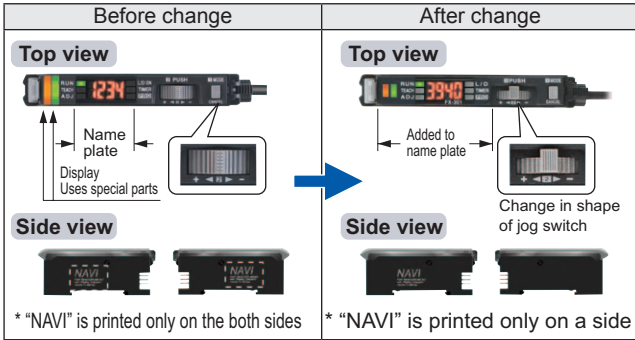

• Checking minor changes between previous and updated models can be done by checking whether the printing is on both sides or only one side.

**Upgraded functions**

**1. Response times added**

An ultra high-speed mode (H-SP) has been added to the existing 4 response time modes [high-speed (FAST), reduced intensity (S-D), standard (STD) and long range (LONG)].

This is changed using "Pro1" in "SPEd".

Before change	After change
<b>4 steps</b>	<b>5 steps</b>
150 μs (FAST)	65 μs (added) (H-SP)
250 μs (S-D)	150 μs (FAST)
250 μs (STD)	250 μs (S-D)
2 ms (LONG)	250 μs (STD)
	2 ms (LONG)

**2. Extension of timer period**

The setting range for the timer period was previously 500 ms, but this has been extended to a new range of 9,999 ms.

**3. Light emitting amount selection function**

The light emitting amount can be changed to one of 4 levels (5 levels when emission halt is included).

**4. Backup, copy lock and key lock functions added**

Backup: This selects whether or not threshold values set by teaching are written to (stored in) an EEPROM.

Copy lock: This selects whether copy function and data bank function communication are possible or not.

Key lock: This disables input using switches to prevent accidental changing of settings.

**Changes in operation**

**1. Timer selection method**

Previous version unit: Timer type was changed using PRO1 mode. The "TIMER" setting in NAVI mode could only be turned on or off.

After change: The type of timer can be changed using the "TIMER" function in NAVI mode.

**2. Checking threshold value in RUN mode**

The threshold values can be checked by turning the jog switch.

**Display changes**

**1. Checking blinking of sensitivity surplus**

The stable surplus display method after teaching has been changed.

Previous version unit: Sensitivity surplus is indicated by the number of blinks of the stability indicator.



**2. Initial direct code value changed**

The factory default settings for the direct codes have been changed.

Previous version unit 0000 → After change 0004

\* The default setting for the timer period is 10 ms, and the direct code for 10 ms is "4", so this has been changed.

**Internal circuit changes**

**1. Addition of an APC circuit**

A four-chemical emitting element which provides stable sensing over long periods has been added, as well as an APC (Auto Power Control) circuit that improves stability during short periods.

**Cautions on sensor connection in cascade**

When connecting the previous version unit (including **FX-301B/G/H**) and updated version unit to be used in a cascade, refer to "Cautions on sensor connection in cascade".

**PRECAUTIONS FOR PROPER USE**

Refer to General precautions, p.80~ for fiber precautions, and to the “PRO mode operation guide” on our website for details pertaining to operating instructions for the amplifier.

**Diagram of functions and settings**

The amplifier features and settings are generally classified into two main modes; the “NAVI mode” for items and settings that are frequently reconfigured, and the “PRO mode” that contains more detailed settings.

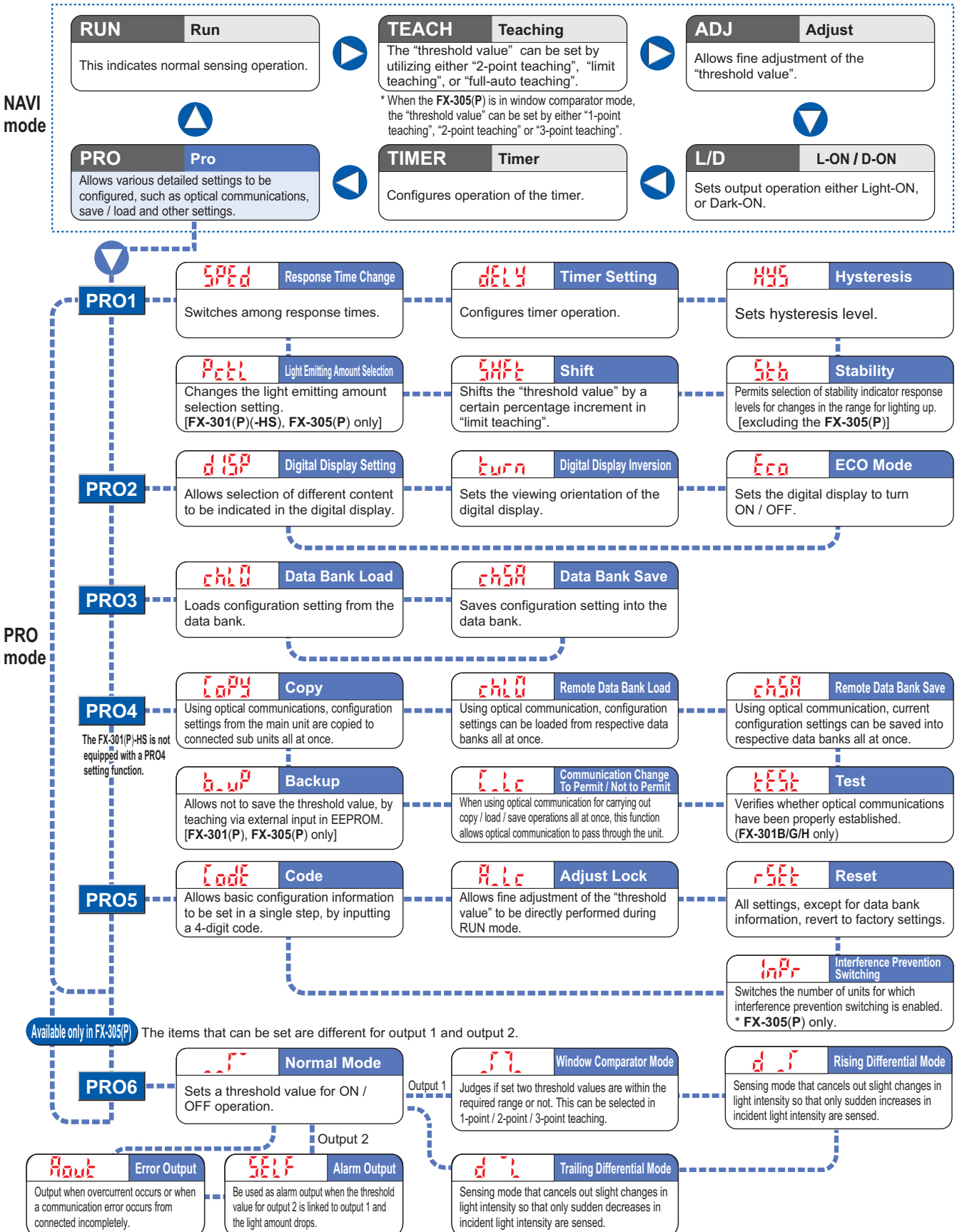

\* The 0-ADJ setting function equipped on the FX-301□ and FX-305(P) has been deleted since the production in May 2005.

FIBER SENSORS

LASER SENSORS

PHOTO-ELECTRIC SENSORS

MICRO PHOTO-ELECTRIC SENSORS

AREA SENSORS

LIGHT CURTAINS

PRESSURE / FLOW SENSORS

INDUCTIVE PROXIMITY SENSORS

PARTICULAR USE SENSORS

SENSOR OPTIONS

SIMPLE WIRE-SAVING UNITS

WIRE-SAVING SYSTEMS

MEASUREMENT SENSORS

STATIC CONTROL DEVICES

ENDOSCOPE

LASER MARKERS

PLC / TERMINALS

HUMAN MACHINE INTERFACES

ENERGY CONSUMPTION VISUALIZATION COMPONENTS

FA COMPONENTS

MACHINE VISION SYSTEMS

UV CURING SYSTEMS

Selection Guide

Fibers

Amplifiers

**FX-500**

**FX-100**

**FX-300**

**FX-410**

**FX-311**

FX-301-F7/ FX-301-F

**DIMENSIONS (Unit: mm in)**

The CAD data in the dimensions can be downloaded from our website.

- FIBER SENSORS
- LASER SENSORS
- PHOTO-ELECTRIC SENSORS
- MICRO PHOTO-ELECTRIC SENSORS
- AREA SENSORS
- LIGHT CURTAINS
- PRESSURE / FLOW SENSORS
- INDUCTIVE PROXIMITY SENSORS
- PARTICULAR USE SENSORS
- SENSOR OPTIONS
- SIMPLE WIRE-SAVING UNITS
- WIRE-SAVING SYSTEMS
- MEASUREMENT SENSORS
- STATIC CONTROL DEVICES
- ENDOSCOPE
- LASER MARKERS
- PLC/ TERMINALS
- HUMAN MACHINE INTERFACES
- ENERGY CONSUMPTION VISUALIZATION COMPONENTS
- FA COMPONENTS
- MACHINE VISION SYSTEMS
- UV CURING SYSTEMS
- Selection Guide
- Fibers
- Amplifiers
- FX-500
- FX-100
- FX-300**
- FX-410
- FX-311
- FX-301-F7/ FX-301-F

**FX-301□ FX-305(P)** Amplifier

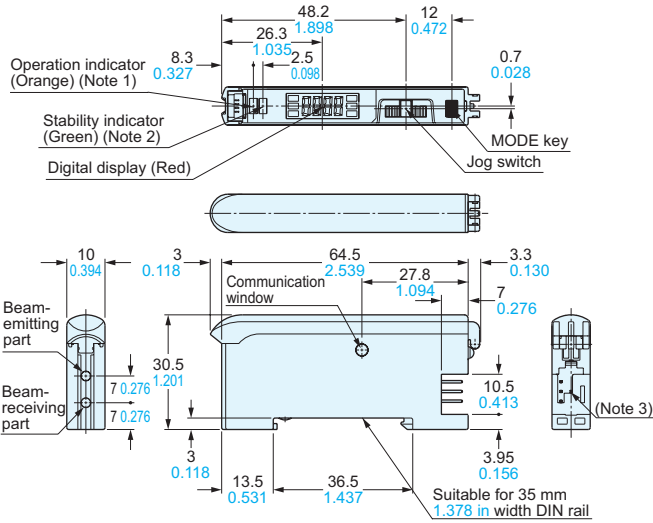

- Notes: 1) **FX-305□**; Output 1 operation indicator (Orange)  
 2) **FX-305□**; Output 2 operation indicator (Orange)  
 3) **FX-301□**; 3-pin, **FX-305□**; 4-pin

**CN-73-C□ CN-74-C□** Main cable (Optional)

• Length L

Model No.	Length L
<b>CN-73/74-C1</b>	1,000 39.370
<b>CN-73/74-C2</b>	2,000 78.740
<b>CN-73/74-C5</b>	5,000 196.850

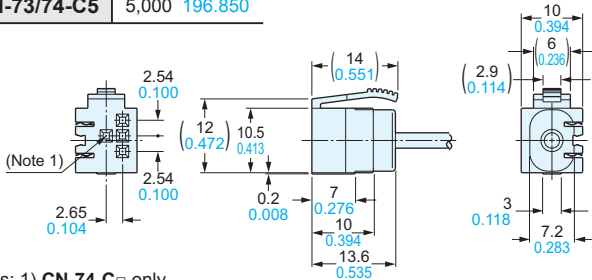
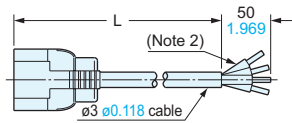

- Notes: 1) **CN-74-C□** only  
 2) **CN-73-C□**; 3-core

**CN-71-C□ CN-72-C□** Sub cable (Optional)

• Length L

Model No.	Length L
<b>CN-71/72-C1</b>	1,000 39.370
<b>CN-71/72-C2</b>	2,000 78.740
<b>CN-71/72-C5</b>	5,000 196.850

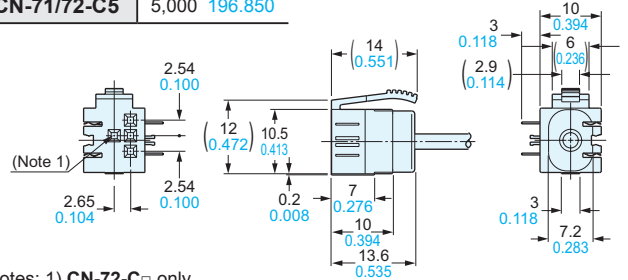
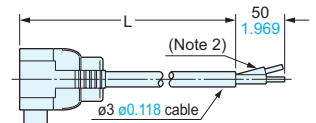

- Notes: 1) **CN-72-C□** only  
 2) **CN-71-C□**; 1-core

**MS-DIN-2** Amplifier mounting bracket (Optional)

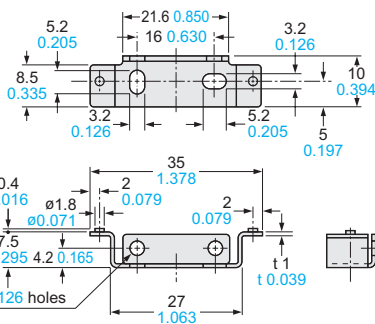

Material: Cold rolled carbon steel (SPCC)  
 (Uni-chrome plated)

**MS-DIN-E** End plate (Optional)

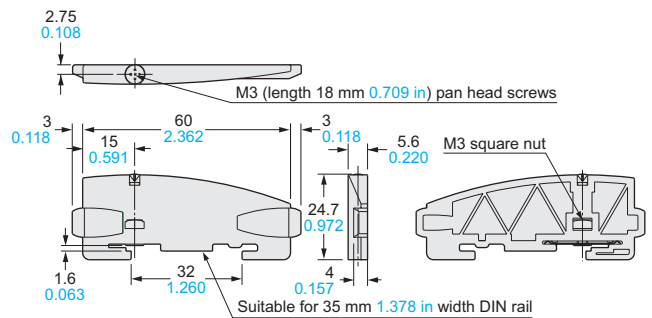

Material: Polycarbonate

## MEMO

