

Data sheet Product DH 3 R

Optoelectronics > LED-holders
without LED, can be strung



Features

insulating body material

PA 4.6. GF

Technical Drawing

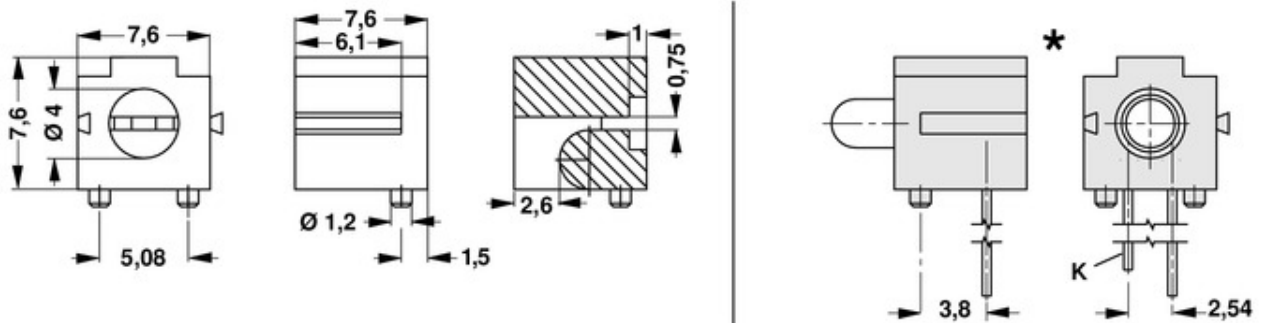

Fischer Elektronik GmbH & Co. KG
DEUTSCHLAND • GERMANY • ALLEMAGNE

Nottebohmstraße 28
58511 Lüdenscheid

Telefon +49 2351 435-0
Telefax +49 2351 45754

info@fischerelektronik.de
www.fischerelektronik.de