

### “ZNR” Transient/Surge Absorbers

Series: **V**  
Type: **D**

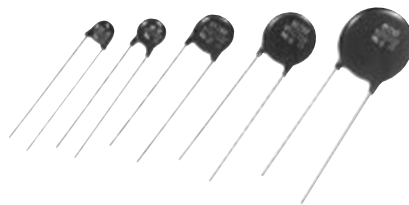

“ZNR” Transient/Surge Absorber, Series V, Type D is released through our continued research in ceramic material composition of ZnO varistor and manufacturing process, featuring large surge current handling capability and energy handling capability for absorbing transient overvoltage in compact size.

#### ■ Features

- Improved Surge Current Handling Capability (@ 8/20  $\mu$ s, 2 times) by 1.5 to 3.0 times over the previous ZNR Series
- Very large Energy Handling Capability and absorption of transient overvoltages in compact sizes
- Wide voltage range
- All standard products which are shown below have received UL, CSA and VDE standards  
Varistor voltage 82-150V : UL  
Varistor voltage 200V over : UL, CSA  
(cf. Application Notes for UL/CSA recognized parts on page 38 to 39)

\* Please contact us about VDE certification

#### ■ Recommended Applications

- Transistor, diode, IC, thyristor or triac semiconductor protection
- Surge protection in consumer electronics
- Surge protection in communication, measuring or controller electronics
- Surge protection in electronic home appliances, gas or petroleum appliances
- Relay or electromagnetic valve surge absorption

#### ■ Precautions for Handling

#### ■ Related Standards

- UL1414, UL1449
- CSA C22.2 No.1 Class 2222 01
- “Type Designation(UL)”, “Part Number(CSA)”
- Are not registered by product Part No..  
(Refer to page 38, for the details)

\* Please contact us about VDE certification

#### ■ Explanation of Part Numbers (Bulk)

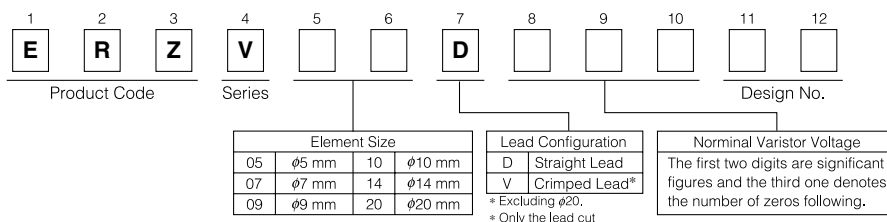

#### ■ Explanation of Part Numbers (Taping)

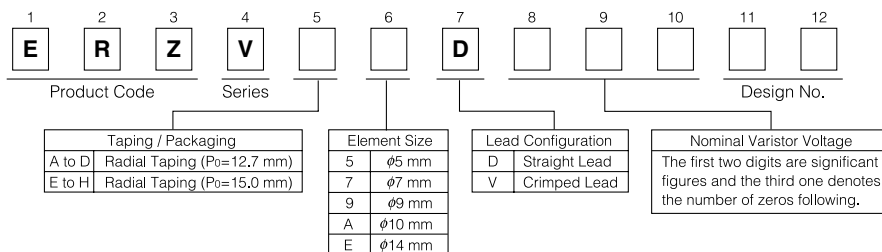

### ■ Reference Guide to Standard Products (ERZV○OD180 to ERZV○OD680)

Part No.	Varistor Voltage*	Maximum Allowable Voltage		Clamping Voltage @ 8/20μs		Maximum Energy (Joule)		Maximum Peak Current @ 8/20μs (A)		Recommended Applications
		ACrms (V)	DC (V)	max.(V)	Ip (A)	i0/1000 μs	2 ms	1 time	2 times	
ERZV05D180	18 (16-20)	11	14	40	1	0.6	0.4	250	125	For the low voltage circuit
ERZV07D180				36	2.5	1.1	0.9	500	250	
ERZV09D180				36	5	2.6	2.2	1000	500	
ERZV10D180				36	5	2.6	2.2	1000	500	
ERZV14D180				36	10	5.2	4.3	2000	1000	
ERZV20D180				36	20	13	12	3000	2000	
ERZV05D220	22 (20-24)	14	18	48	1	0.7	0.5	250	125	
ERZV07D220				43	2.5	1.3	1.1	500	250	
ERZV09D220				43	5	3.2	2.6	1000	500	
ERZV10D220				43	5	3.2	2.6	1000	500	
ERZV14D220				43	10	6.3	5.3	2000	1000	
ERZV20D220				43	20	16	14	3000	2000	
ERZV05D270	27 (24-30)	17	22	60	1	0.9	0.7	250	125	
ERZV07D270				53	2.5	1.6	1.3	500	250	
ERZV09D270				53	5	3.9	3.2	1000	500	
ERZV10D270				53	5	3.9	3.2	1000	500	
ERZV14D270				53	10	7.8	6.5	2000	1000	
ERZV20D270				53	20	19	17	3000	2000	
ERZV05D330	33 (30-36)	20	26	73	1	1.1	0.8	250	125	
ERZV07D330				65	2.5	2.0	1.6	500	250	
ERZV09D330				65	5	4.8	4.0	1000	500	
ERZV10D330				65	5	4.8	4.0	1000	500	
ERZV14D330				65	10	9.5	7.9	2000	1000	
ERZV20D330				65	20	24	21	3000	2000	
ERZV05D390	39 (35-43)	25	31	86	1	1.2	0.9	250	125	
ERZV07D390				77	2.5	2.4	1.9	500	250	
ERZV09D390				77	5	5.6	4.7	1000	500	
ERZV10D390				77	5	5.6	4.7	1000	500	
ERZV14D390				77	10	11	9.4	2000	1000	
ERZV20D390				77	20	28	25	3000	2000	
ERZV05D470	47 (42-52)	30	38	104	1	1.5	1.1	250	125	
ERZV07D470				93	2.5	2.8	2.3	500	250	
ERZV09D470				93	5	6.8	5.6	1000	500	
ERZV10D470				93	5	6.8	5.6	1000	500	
ERZV14D470				93	10	14	11	2000	1000	
ERZV20D470				93	20	34	30	3000	2000	
ERZV05D560	56 (50-62)	35	45	123	1	1.8	1.3	250	125	
ERZV07D560				110	2.5	3.4	2.7	500	250	
ERZV09D560				110	5	8.1	6.7	1000	500	
ERZV10D560				110	5	8.1	6.7	1000	500	
ERZV14D560				110	10	16	13	2000	1000	
ERZV20D560				110	20	41	36	3000	2000	
ERZV05D680	68 (61-75)	40	56	150	1	2.2	1.6	250	125	
ERZV07D680				135	2.5	4.1	3.3	500	250	
ERZV09D680				135	5	9.8	8.2	1000	500	
ERZV10D680				135	5	9.8	8.2	1000	500	
ERZV14D680				135	10	20	16	2000	1000	
ERZV20D680				135	20	49	44	3000	2000	

\* Measuring Current of Varistor Voltage  
 5 Series (ERZV05D180 to ERZV05D680): 0.1 mA  
 Others: 1 mA

#### ● Rated Power

Part Number	Rated Power (W)
ERZV05D180 to ERZV05D680	0.01
ERZV07D180 to ERZV07D680	0.02
ERZV09D180 to ERZV09D680	0.05
ERZV10D180 to ERZV10D680	0.05
ERZV14D180 to ERZV14D680	0.10
ERZV20D180 to ERZV20D680	0.20

● Operating Temperature Range: -40 to 85 °C

● Storage Temperature Range: -40 to 125 °C

### ■ Reference Guide to Standard Products (ERZV○D820 to ERZV○D182)

Part No.	Varistor Voltage*	Maximum Allowable Voltage		Clamping Voltage @ 8/20μs		Maximum Energy (Joule)		Maximum Peak Current @ 8/20μs (A)		Recommended Applications	
	(V)	ACrms (V)	DC (V)	max.(V)	Ip (A)	10/1000 μs	2 ms	1 time	2 times		
ERZV05D820	82 (74-90)	50	65	145	5	3.5	2.5	800	600	Telephone, Communication Line (DC 48 V)	
ERZV07D820				135	10	7	5	1750	1250		
ERZV09D820				135	25	14	10	3500	2500		
ERZV10D820				135	25	14	10	3500	2500		
ERZV14D820				135	50	28	20	6000	5000		
ERZV20D820				135	100	56	40	10000	7000		
ERZV05D101	100 (90-110)	60	85	175	5	4	3	800	600		
ERZV07D101				165	10	8.5	6	1750	1250		
ERZV09D101				165	25	17	12	3500	2500		
ERZV10D101				165	25	17	12	3500	2500		
ERZV14D101				165	50	35	25	6000	5000		
ERZV20D101				165	100	70	50	10000	7000		
ERZV05D121	120 (108-132)	75	100	210	5	5	3.5	800	600		
ERZV07D121				200	10	10	7	1750	1250		
ERZV09D121				200	25	20	14.5	3500	2500		
ERZV10D121				200	25	20	14.5	3500	2500		
ERZV14D121				200	50	42	30	6000	5000		
ERZV20D121				200	100	85	60	10000	7000		
ERZV05D151	150 (135-165)	95	125	260	5	6.5	4.5	800	600		
ERZV07D151				250	10	13	9	1750	1250		
ERZV09D151				250	25	25	18	3500	2500		
ERZV10D151				250	25	25	18	3500	2500		
ERZV14D151				250	50	53	37.5	6000	5000		
ERZV20D151				250	100	106	75	10000	7000		
ERZV05D201	200 (185-225)	130	170	355	5	8.5	6	800	600	AC 100 V Line-Line Applications	
ERZV07D201				340	10	17.5	12.5	1750	1250		
ERZV09D201				340	25	35	25	3500	2500		
ERZV10D201				340	25	35	25	3500	2500		
ERZV14D201				340	50	70	50	6000	5000		
ERZV20D201				340	100	140	100	10000	7000		
ERZV05D221	220 (198-242)	140	180	380	5	9	6.5	800	600		
ERZV07D221				360	10	19	13.5	1750	1250		
ERZV09D221				360	25	39	27.5	3500	2500		
ERZV10D221				360	25	39	27.5	3500	2500		
ERZV14D221				360	50	78	55	6000	5000		
ERZV20D221				360	100	155	110	10000	7000		
ERZV05D241	240 (216-264)	150	200	415	5	10.5	7.5	800	600		AC 100 V to 120 V, Line-Line Applications
ERZV07D241				395	10	21	15	1750	1250		
ERZV09D241				395	25	42	30	3500	2500		
ERZV10D241				395	25	42	30	3500	2500		
ERZV14D241				395	50	84	60	6000	5000		
ERZV20D241				395	100	168	120	10000	7000		
ERZV05D271	270 (247-303)	175	225	475	5	11	8	800	600		
ERZV07D271				455	10	24	17	1750	1250		
ERZV09D271				455	25	49	35	3500	2500		
ERZV10D271				455	25	49	35	3500	2500		
ERZV14D271				455	50	99	70	6000	5000		
ERZV20D271				455	100	190	135	10000	7000		
ERZV05D331	330 (297-363)	210	270	570	5	13	9.5	800	600	AC 100 V to 120 V, Line-Line Applications  Telephone Line Application, (250 V Insulation Resistance Test Applicable)	
ERZV07D331				545	10	28	20	1750	1250		
ERZV09D331				545	25	58	42	3500	2500		
ERZV10D331				545	25	58	42	3500	2500		
ERZV14D331				545	50	115	80	6000	4500		
ERZV20D331				545	100	228	160	10000	6500		
ERZV05D361	360 (324-396)	230	300	620	5	16	11	800	600		
ERZV07D361				595	10	32	23	1750	1250		
ERZV09D361				595	25	65	45	3500	2500		
ERZV10D361				595	25	65	45	3500	2500		
ERZV14D361				595	50	130	90	6000	4500		
ERZV20D361				595	100	255	180	10000	6500		
ERZV05D391	390 (351-429)	250	320	675	5	17	12	800	600		
ERZV07D391				650	10	35	25	1750	1250		
ERZV09D391				650	25	70	50	3500	2500		
ERZV10D391				650	25	70	50	3500	2500		
ERZV14D391				650	50	140	100	6000	4500		
ERZV20D391				650	100	275	195	10000	6500		

## ■ Reference Guide to Standard Products

Part No.	Varistor Voltage*		Maximum Allowable Voltage		Clamping Voltage @ 8/20μs		Maximum Energy (Joule)		Maximum Peak Current @ 8/20 μs (A)		Recommended Applications
	DC (V)	ACrms (V)	DC (V)	max.(V)	I <sub>p</sub> (A)	10/1000 μs	2 ms	1 time	2 times		
ERZV05D431	430 (387-473)	275	350	745	5	20	13.5	800	600	AC 120 V, 200 V, 220 V, Line-Line and AC 100 V to 220 V, Line-Ground Applications	
ERZV07D431				710	10	40	27.5	1750	1250		
ERZV09D431				710	25	80	55	3500	2500		
ERZV10D431				710	25	80	55	3500	2500		
ERZV14D431				710	50	155	110	6000	4500		
ERZV20D431				710	100	303	215	10000	6500		
ERZV05D471	470 (423-517)	300	385	810	5	21	15	800	600	AC 200 V, 220 V, Line-Line and AC 100 V to 220 V, Line-Ground Applications	
ERZV07D471				775	10	42	30	1750	1250		
ERZV09D471				775	25	85	60	3500	2500		
ERZV10D471				775	25	85	60	3500	2500		
ERZV14D471				775	50	175	125	6000	4500		
ERZV20D471				775	100	350	250	10000	6500		
ERZV07D511	510 (459-561)	320	410	845	10	45	32	1750	1250	AC 240 V, Line-Line Applications	
ERZV09D511				845	25	92	67	3500	2500		
ERZV10D511				845	25	92	67	3500	2500		
ERZV14D511				845	50	190	136	6000	4500		
ERZV20D511				845	100	382	273	10000	6500		
ERZV10D621	620 (558-682)	385	505	1025	25	92	67	3500	2500	AC 240 V, Line-Line Applications	
ERZV14D621				1025	50	190	136	5000	4500		
ERZV20D621				1025	100	382	273	7500	6500		
ERZV10D681	680 (612-748)	420	560	1120	25	92	67	3500	2500	AC 380 V, Line-Line and Line-Ground Applications (For DC 500V Insulating Test)	
ERZV14D681				1120	50	190	136	5000	4500		
ERZV20D681				1120	100	382	273	7500	6500		
ERZV10D751	750 (675-825)	460	615	1240	25	100	70	3500	2500	AC 380 V, Line-Line and Line-Ground Applications (For DC 500V Insulating Test)	
ERZV14D751				1240	50	210	150	5000	4500		
ERZV20D751				1240	100	420	300	7500	6500		
ERZV10D821	820 (738-902)	510	670	1355	25	110	80	3500	2500	AC 415 V, Line-Line and Line-Ground Applications (For DC 500V Insulating Test)	
ERZV14D821				1355	50	235	165	5000	4500		
ERZV20D821				1355	100	460	325	7500	6500		
ERZV10D911	910 (819-1001)	550	745	1500	25	130	90	3500	2500	AC 415 V, Line-Line and Line-Ground Applications (For DC 500V Insulating Test)	
ERZV14D911				1500	50	255	180	5000	4500		
ERZV20D911				1500	100	510	360	7500	6500		
ERZV10D102	1000 (900-1100)	625	825	1650	25	140	100	3500	2500	AC 480 V, Line-Line and Line-Ground Applications (For DC 500V Insulating Test)	
ERZV14D102				1650	50	280	200	5000	4500		
ERZV20D102				1650	100	565	400	7500	6500		
ERZV10D112	1100 (990-1210)	680	895	1815	25	155	110	3500	2500	AC 480 V, Line-Line and Line-Ground Applications (For DC 500V Insulating Test)	
ERZV14D112				1815	50	310	220	5000	4500		
ERZV20D112				1815	100	620	440	7500	6500		
ERZV10D182CS	1800 (1700-1980)	1000	1465	2970	25	247	183	3500	2500	Line-Ground Applications (For AC 1200V Withstanding Test)	
ERZV14D182CS				2970	50	510	360	5000	4500		
ERZV20D182				2970	100	1020	720	7500	6500		

\* Measuring Current of Varistor Voltage  
 5 Series (ERZV05D820 to ERZV05D471): 0.1 mA  
 Others: 1 mA

### ● Rated Power

Part Number	Rated Power (W)
ERZV05D820 to ERZV05D471	0.10
ERZV07D820 to ERZV07D511	0.25
ERZV09D820 to ERZV09D511	0.40
ERZV10D820 to ERZV10D182CS	0.40
ERZV14D820 to ERZV14D182CS	0.60
ERZV20D820 to ERZV20D182	1.00

### ● Operating Temperature Range: -40 to 85 °C

### ● Storage Temperature Range: -40 to 125 °C

### 5 Series

#### ■ Ratings and Characteristics

- Operating Temperature Range : -40 to 85 °C
- Storage Temperature Range : -40 to 125 °C
- Temperature Coefficient of Varistor Voltage : 0 to -0.05 %/°C

#### ERZV05D180 to ERZV05D680

Part No.	Varistor Voltage	Maximum Allowable Voltage		Clamping Voltage (max.)	Rated Power	Maximum Energy		Maximum Peak Current (8/20 μs)		Capacitance (max.)
						10/1000 μs	(2 ms)	1 time	2 times	
						$V_{0.1mA}$ (V)	ACrms (V)	DC (V)	$V_{1A}$ (V)	
ERZV05D180	18 (16-20)	11	14	40	0.01	0.6	0.4	250	125	1600
ERZV05D220	22 (20-24)	14	18	48	0.01	0.7	0.5	250	125	1500
ERZV05D270	27 (24-30)	17	22	60	0.01	0.9	0.7	250	125	1450
ERZV05D330	33 (30-36)	20	26	73	0.01	1.1	0.8	250	125	1400
ERZV05D390	39 (35-43)	25	31	86	0.01	1.2	0.9	250	125	700
ERZV05D470	47 (42-52)	30	38	104	0.01	1.5	1.1	250	125	650
ERZV05D560	56 (50-62)	35	45	123	0.01	1.8	1.3	250	125	600
ERZV05D680	68 (61-75)	40	56	150	0.01	2.2	1.6	250	125	580

#### ERZV05D820 to ERZV05D471

Part No.	Varistor Voltage	Maximum Allowable Voltage		Clamping Voltage (max.)	Rated Power	Maximum Energy		Maximum Peak Current (8/20 μs)		Capacitance (max.)
						10/1000 μs	(2 ms)	1 time	2 times	
						$V_{0.1mA}$ (V)	ACrms (V)	DC (V)	$V_{5A}$ (V)	
ERZV05D820	82 (74-90)	50	65	145	0.1	3.5	2.5	800	600	460
ERZV05D101	100(90-110)	60	85	175	0.1	4.0	3.0	800	600	400
ERZV05D121	120(108-132)	75	100	210	0.1	5.0	3.5	800	600	350
ERZV05D151	150(135-165)	95	125	260	0.1	6.5	4.5	800	600	300
ERZV05D201	200(185-225)	130	170	355	0.1	8.5	6.0	800	600	120
ERZV05D221	220(198-242)	140	180	380	0.1	9.0	6.5	800	600	110
ERZV05D241	240(216-264)	150	200	415	0.1	10.5	7.5	800	600	100
ERZV05D271	270(247-303)	175	225	475	0.1	11.0	8.0	800	600	90*
ERZV05D331	330(297-363)	210	270	570	0.1	13.0	9.5	800	600	80*
ERZV05D361	360(324-396)	230	300	620	0.1	16.0	11.0	800	600	80*
ERZV05D391	390(351-429)	250	320	675	0.1	17.0	12.0	800	600	80*
ERZV05D431	430(387-473)	275	350	745	0.1	20.0	13.5	800	600	70*
ERZV05D471	470(423-517)	300	385	810	0.1	21.0	15.0	800	600	60*

\* Measured at 1 MHz

### ■ Dimensions in mm (not to scale)

#### ERZV05D180 to ERZV05D680

Part No.	D max.	T max.	W	H max.	L
ERZV05D180	7.0	4.5	5.0±1.0	10.0	1.5±1.0
ERZV05D220	7.0	4.5	5.0±1.0	10.0	1.5±1.0
ERZV05D270	7.0	4.5	5.0±1.0	10.0	1.5±1.0
ERZV05D330	7.0	4.5	5.0±1.0	10.0	1.5±1.0
ERZV05D390	7.0	4.5	5.0±1.0	10.0	1.5±1.0
ERZV05D470	7.0	4.5	5.0±1.0	10.0	1.5±1.0
ERZV05D560	7.0	4.5	5.0±1.0	10.0	1.5±1.0
ERZV05D680	7.0	4.5	5.0±1.0	10.0	1.5±1.0

#### ERZV05D820 to ERZV05D471

Part No.	D max.	T max.	W	H max.	L
ERZV05D820	7.0	4.1	5.0±1.0	10.0	1.4±1.0
ERZV05D101	7.0	4.3	5.0±1.0	10.0	1.6±1.0
ERZV05D121	7.0	4.5	5.0±1.0	10.0	1.8±1.0
ERZV05D151	7.0	4.8	5.0±1.0	10.0	2.1±1.0
ERZV05D201	7.0	4.4	5.0±1.0	10.0	1.7±1.0
ERZV05D221	7.0	4.5	5.0±1.0	10.0	1.8±1.0
ERZV05D241	7.0	4.6	5.0±1.0	10.0	1.9±1.0
ERZV05D271	7.0	4.8	5.0±1.0	10.0	2.1±1.0
ERZV05D331	7.0	5.1	5.0±1.0	10.0	2.4±1.0
ERZV05D361	7.0	5.3	5.0±1.0	10.0	2.5±1.0
ERZV05D391	7.0	5.4	5.0±1.0	10.0	2.7±1.0
ERZV05D431	7.0	5.6	5.0±1.0	10.0	2.9±1.0
ERZV05D471	7.0	5.8	5.0±1.0	10.0	3.1±1.0

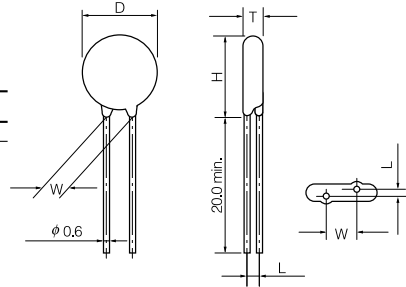

### ■ Typical Characteristics

#### Voltage vs. Current

##### (ERZV05D180 to ERZV05D680)

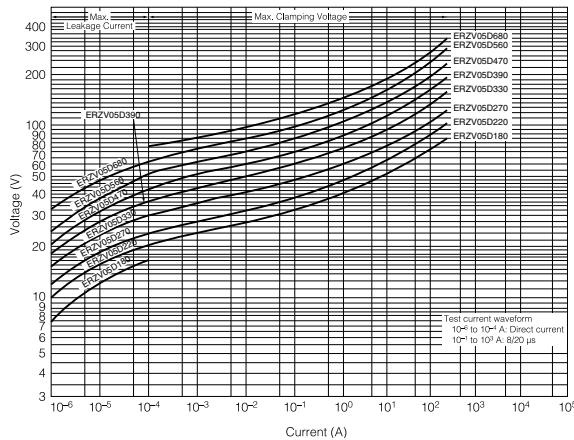

##### (ERZV05D820 to ERZV05D471)

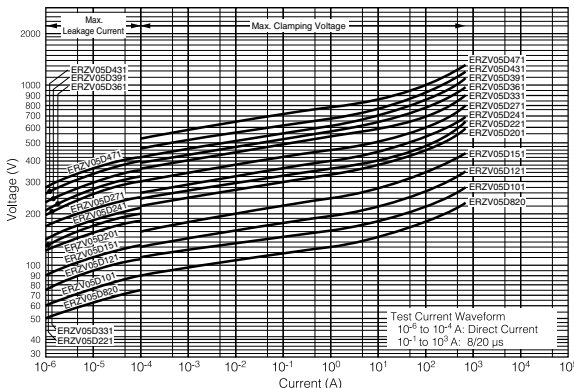

### Impulse Derating (Relation between impulse

width and impulse repetition times)

#### (ERZV05D180 to ERZV05D680)

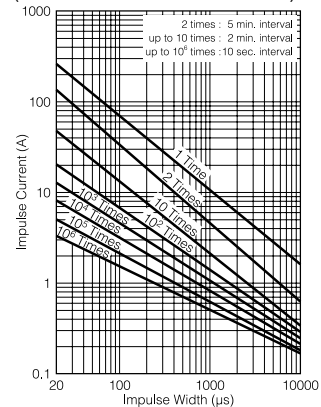

#### (ERZV05D820 to ERZV05D471)

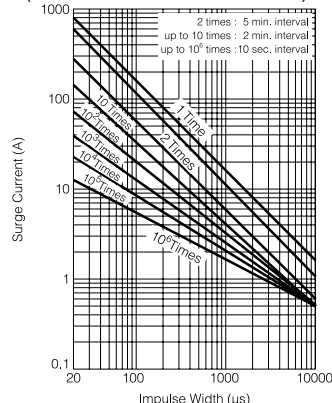

### 7 Series

#### ■ Ratings and Characteristics

- Operating Temperature Range : -40 to 85 °C
- Storage Temperature Range : -40 to 125 °C
- Temperature Coefficient of Varistor Voltage : 0 to -0.05 %/°C

#### ERZV07D180 to ERZV07D680

Part No.	Varistor Voltage	Maximum Allowable Voltage		Clamping Voltage (max.)	Rated Power	Maximum Energy		Maximum Peak Current (8/20 μs)		Capacitance (max.)
						(10/1000 μs)	(2 ms)	1 time	2 times	
						V <sub>1mA</sub> (V)	ACrms (V)	DC (V)	V <sub>2.5A</sub> (V)	
ERZV07D180	18 (16-20)	11	14	36	0.02	1.1	0.9	500	250	3800
ERZV07D220	22 (20-24)	14	18	43	0.02	1.3	1.1	500	250	3600
ERZV07D270	27 (24-30)	17	22	53	0.02	1.6	1.3	500	250	3400
ERZV07D330	33 (30-36)	20	26	65	0.02	2.0	1.6	500	250	2900
ERZV07D390	39 (35-43)	25	31	77	0.02	2.4	1.9	500	250	1600
ERZV07D470	47 (42-52)	30	38	93	0.02	2.8	2.3	500	250	1550
ERZV07D560	56 (50-62)	35	45	110	0.02	3.4	2.7	500	250	1500
ERZV07D680	68 (61-75)	40	56	135	0.02	4.1	3.3	500	250	1200

#### ERZV07D820 to ERZV07D511

Part No.	Varistor Voltage	Maximum Allowable Voltage		Clamping Voltage (max.)	Rated Power	Maximum Energy		Maximum Peak Current (8/20 μs)		Capacitance (max.)
						(10/1000 μs)	(2 ms)	1 time	2 times	
						V <sub>1mA</sub> (V)	ACrms (V)	DC (V)	V <sub>10A</sub> (V)	
ERZV07D820	82( 74- 90)	50	65	135	0.25	7	5	1750	1250	810
ERZV07D101	100( 90-110)	60	85	165	0.25	8.5	6	1750	1250	700
ERZV07D121	120(108-132)	75	100	200	0.25	10	7	1750	1250	590
ERZV07D151	150(135-165)	95	125	250	0.25	13	9	1750	1250	500
ERZV07D201	200(185-225)	130	170	340	0.25	17.5	12.5	1750	1250	200
ERZV07D221	220(198-242)	140	180	360	0.25	19	13.5	1750	1250	190
ERZV07D241	240(216-264)	150	200	395	0.25	21	15	1750	1250	170
ERZV07D271	270(247-303)	175	225	455	0.25	24	17	1750	1250	150
ERZV07D331	330(297-363)	210	270	545	0.25	28	20	1750	1250	130
ERZV07D361	360(324-396)	230	300	595	0.25	32	23	1750	1250	130
ERZV07D391	390(351-429)	250	320	650	0.25	35	25	1750	1250	130
ERZV07D431	430(387-473)	275	350	710	0.25	40	27.5	1750	1250	120
ERZV07D471	470(423-517)	300	385	775	0.25	42	30	1750	1250	100
ERZV07D511	510(459-561)	320	410	845	0.25	45	32	1750	1250	90*

\* Measured at 1 MHz

### ■ Dimensions in mm (not to scale)

#### ERZV07D180 to ERZV07D680

Part No.	D max.	T max.	W	H max.	L
ERZV07D180	8.5	4.5	5.0±1.0	11.5	1.3±1.0
ERZV07D220	8.5	4.6	5.0±1.0	11.5	1.4±1.0
ERZV07D270	8.5	4.7	5.0±1.0	11.5	1.5±1.0
ERZV07D330	8.5	4.9	5.0±1.0	11.5	1.7±1.0
ERZV07D390	8.5	4.8	5.0±1.0	11.5	1.6±1.0
ERZV07D470	8.5	4.9	5.0±1.0	11.5	1.7±1.0
ERZV07D560	8.5	5.0	5.0±1.0	11.5	1.8±1.0
ERZV07D680	8.5	5.2	5.0±1.0	11.5	2.0±1.0

#### ERZV07D820 to ERZV07D511

Part No.	D max.	T max.	W	H max.	L
ERZV07D820	8.5	4.1	5.0±1.0	11.5	1.4±1.0
ERZV07D101	8.5	4.3	5.0±1.0	11.5	1.6±1.0
ERZV07D121	8.5	4.5	5.0±1.0	11.5	1.8±1.0
ERZV07D151	8.5	4.8	5.0±1.0	11.5	2.1±1.0
ERZV07D201	8.5	4.4	5.0±1.0	11.5	1.7±1.0
ERZV07D221	8.5	4.5	5.0±1.0	11.5	1.8±1.0
ERZV07D241	8.5	4.6	5.0±1.0	11.5	1.9±1.0
ERZV07D271	8.5	4.8	5.0±1.0	11.5	2.1±1.0
ERZV07D331	8.5	5.1	5.0±1.0	11.5	2.4±1.0
ERZV07D361	8.5	5.3	5.0±1.0	11.5	2.5±1.0
ERZV07D391	8.5	5.4	5.0±1.0	11.5	2.7±1.0
ERZV07D431	8.5	5.6	5.0±1.0	11.5	2.9±1.0
ERZV07D471	8.5	5.8	5.0±1.0	11.5	3.1±1.0
ERZV07D511	8.5	6.0	5.0±1.0	11.5	3.3±1.0

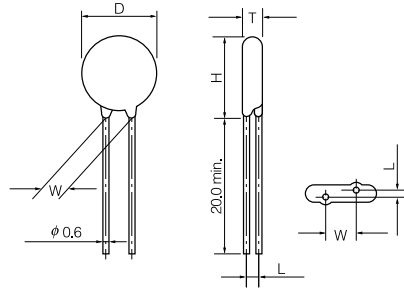

### ■ Typical Characteristics

#### Voltage vs. Current

##### (ERZV07D180 to ERZV07D680)

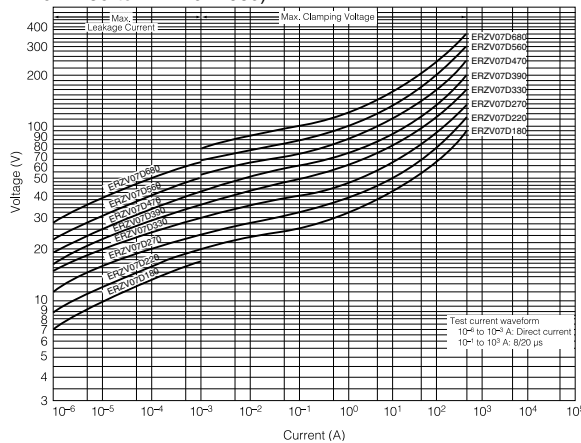

##### (ERZV07D820 to ERZV07D511)

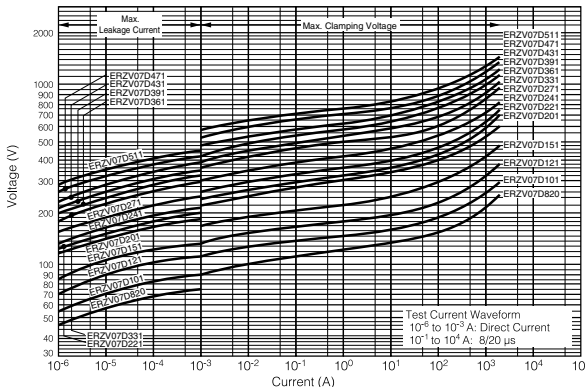

#### Impulse Deratings (Relation between impulse width and impulse repetition times)

##### (ERZV07D180 to ERZV07D680)

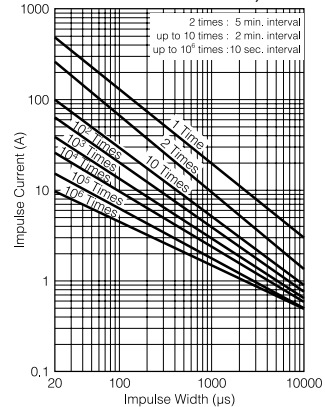

##### (ERZV07D820 to ERZV07D511)

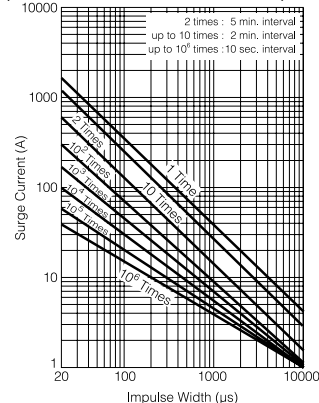



### 9 Series

#### ■ Ratings and Characteristics

- Operating Temperature Range : -40 to 85 °C
- Storage Temperature Range : -40 to 125 °C
- Temperature Coefficient of Varistor Voltage : 0 to -0.05 %/°C

#### ERZV09D180 to ERZV09D680

Part No.	Varistor Voltage	Maximum Allowable Voltage		Clamping Voltage (max.)	Rated Power	Maximum Energy		Maximum Peak Current (8/20 μs)		Capacitance (max.)
						(10/1000 μs)	(2 ms)	1 time	2 times	
						V <sub>1mA</sub> (V)	ACrms (V)	DC (V)	V <sub>5A</sub> (V)	
ERZV09D180	18 (16-20)	11	14	36	0.05	2.6	2.2	1000	500	16000
ERZV09D220	22 (20-24)	14	18	43	0.05	3.2	2.6	1000	500	11000
ERZV09D270	27 (24-30)	17	22	53	0.05	3.9	3.2	1000	500	8000
ERZV09D330	33 (30-36)	20	26	65	0.05	4.8	4.0	1000	500	6300
ERZV09D390	39 (35-43)	25	31	77	0.05	5.6	4.7	1000	500	5200
ERZV09D470	47 (42-52)	30	38	93	0.05	6.8	5.6	1000	500	4600
ERZV09D560	56 (50-62)	35	45	110	0.05	8.1	6.7	1000	500	3750
ERZV09D680	68 (61-75)	40	56	135	0.05	9.8	8.2	1000	500	2800

#### ERZV09D820 to ERZV09D511

Part No.	Varistor Voltage	Maximum Allowable Voltage		Clamping Voltage (max.)	Rated Power	Maximum Energy		Maximum Peak Current (8/20 μs)		Capacitance (max.)
						(10/1000 μs)	(2 ms)	1 time	2 times	
						V <sub>1mA</sub> (V)	ACrms (V)	DC (V)	V <sub>25A</sub> (V)	
ERZV09D820	82( 74 - 90)	50	65	135	0.4	14	10	3500	2500	2000
ERZV09D101	100( 90 - 110)	60	85	165	0.4	17	12	3500	2500	1700
ERZV09D121	120(108 - 132)	75	100	200	0.4	20	14.5	3500	2500	1400
ERZV09D151	150(135 - 165)	95	125	250	0.4	25	18	3500	2500	1100
ERZV09D201	200(185 - 225)	130	170	340	0.4	35	25	3500	2500	430
ERZV09D221	220(198 - 242)	140	180	360	0.4	39	27.5	3500	2500	410
ERZV09D241	240(216 - 264)	150	200	395	0.4	42	30	3500	2500	380
ERZV09D271	270(247 - 303)	175	225	455	0.4	49	35	3500	2500	350
ERZV09D331	330(297 - 363)	210	270	545	0.4	58	42	3500	2500	300
ERZV09D361	360(324 - 396)	230	300	595	0.4	65	45	3500	2500	300
ERZV09D391	390(351 - 429)	250	320	650	0.4	70	50	3500	2500	300
ERZV09D431	430(387 - 473)	275	350	710	0.4	80	55	3500	2500	270
ERZV09D471	470(423 - 517)	300	385	775	0.4	85	60	3500	2500	230
ERZV09D511	510(459 - 561)	320	410	845	0.4	92	67	3500	2500	210

### ■ Dimensions in mm (not to scale)

#### ERZV09D180 to ERZV09D680

Part No.	D max.	T max.	W	H max.	L
ERZV09D180	11.5	3.8	5.0±0.5	14.0	1.3±1.0
ERZV09D220	11.5	4.0	5.0±0.5	14.0	1.4±1.0
ERZV09D270	11.5	4.2	5.0±0.5	14.0	1.5±1.0
ERZV09D330	11.5	4.5	5.0±0.5	14.0	1.7±1.0
ERZV09D390	11.5	4.0	5.0±0.5	14.0	1.7±1.0
ERZV09D470	11.5	4.2	5.0±0.5	14.0	1.8±1.0
ERZV09D560	11.5	4.4	5.0±0.5	14.0	1.9±1.0
ERZV09D680	11.5	4.5	5.0±0.5	14.0	2.2±1.0

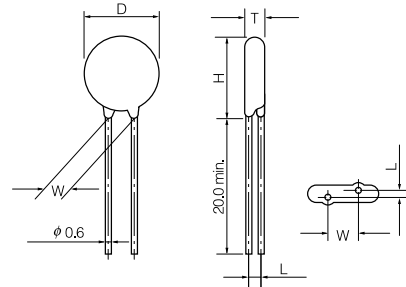

#### ERZV09D820 to ERZV09D511

Part No.	D max.	T max.	W	H max.	L
ERZV09D820	11.5	3.8	5.0±0.5	14.0	1.6±1.0
ERZV09D101	11.5	3.9	5.0±0.5	14.0	1.8±1.0
ERZV09D121	11.5	4.1	5.0±0.5	14.0	2.0±1.0
ERZV09D151	11.5	4.4	5.0±0.5	14.0	2.2±1.0
ERZV09D201	11.5	4.1	5.0±0.5	14.0	1.7±1.0
ERZV09D221	11.5	4.2	5.0±0.5	14.0	1.8±1.0
ERZV09D241	11.5	4.3	5.0±0.5	14.0	1.9±1.0
ERZV09D271	11.5	4.5	5.0±0.5	14.0	2.0±1.0
ERZV09D331	11.5	4.8	5.0±0.5	14.0	2.3±1.0
ERZV09D361	11.5	5.0	5.0±0.5	14.0	2.5±1.0
ERZV09D391	11.5	5.1	5.0±0.5	14.0	2.6±1.0
ERZV09D431	11.5	5.3	5.0±0.5	14.0	2.8±1.0
ERZV09D471	11.5	5.6	5.0±0.5	14.0	3.1±1.0
ERZV09D511	11.5	5.8	5.0±0.5	14.0	3.2±1.0

### ■ Typical Characteristics

#### Voltage vs. Current

##### (ERZV09D180 to ERZV09D680)

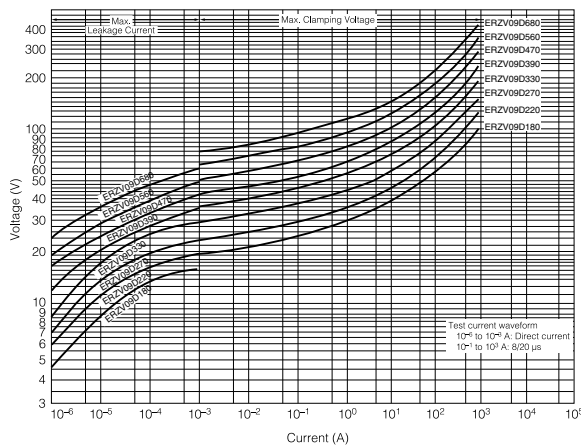

#### Impulse Derating (Relation between impulse width and impulse repetition times)

##### (ERZV09D180 to ERZV09D680)

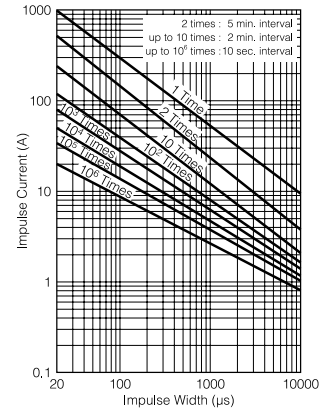

##### (ERZV09D820 to ERZV09D511)

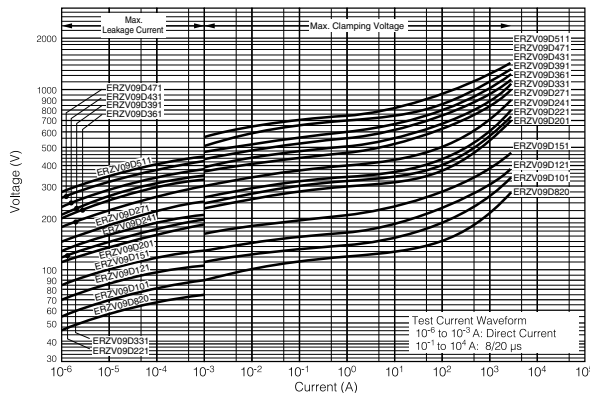

##### (ERZV09D820 to ERZV09D511)

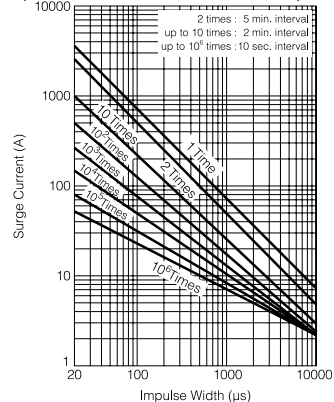

### 10 Series

#### ■ Ratings and Characteristics

- Operating Temperature Range : -40 to 85 °C
- Storage Temperature Range : -40 to 125 °C
- Temperature Coefficient of Varistor Voltage : 0 to -0.05 %/°C

#### ERZV10D180 to ERZV10D680

Part No.	Varistor Voltage	Maximum Allowable Voltage		Clamping Voltage (max.)	Rated Power	Maximum Energy		Maximum Peak Current (8/20 μs)		Capacitance (max.) @1 kHz (pF)		
		ACrms (V)	DC (V)			V <sub>25A</sub> (V)	(W)	(10/1000 μs)	(2 ms)		1 time	2 times
								(J)	(J)		(A)	(A)
ERZV10D180	18 (16-20)	11	14	36	0.05	2.6	2.2	1000	500	16000		
ERZV10D220	22 (20-24)	14	18	43	0.05	3.2	2.6	1000	500	11000		
ERZV10D270	27 (24-30)	17	22	53	0.05	3.9	3.2	1000	500	8000		
ERZV10D330	33 (30-36)	20	26	65	0.05	4.8	4.0	1000	500	6300		
ERZV10D390	39 (35-43)	25	31	77	0.05	5.6	4.7	1000	500	5200		
ERZV10D470	47 (42-52)	30	38	93	0.05	6.8	5.6	1000	500	4600		
ERZV10D560	56 (50-62)	35	45	110	0.05	8.1	6.7	1000	500	3750		
ERZV10D680	68 (61-75)	40	56	135	0.05	9.8	8.2	1000	500	2800		

#### ERZV10D820 to ERZV10D182CS

Part No.	Varistor Voltage	Maximum Allowable Voltage		Clamping Voltage (max.)	Rated Power	Maximum Energy		Maximum Peak Current (8/20 μs)		Capacitance (max.) @1 kHz (pF)		
		ACrms (V)	DC (V)			V <sub>25A</sub> (V)	(W)	(10/1000 μs)	(2 ms)		1 time	2 times
								(J)	(J)		(A)	(A)
ERZV10D820	82( 74- 90)	50	65	135	0.4	14	10	3500	2500	2000		
ERZV10D101	100( 90- 110)	60	85	165	0.4	17	12	3500	2500	1700		
ERZV10D121	120( 108- 132)	75	100	200	0.4	20	14.5	3500	2500	1400		
ERZV10D151	150( 135- 165)	95	125	250	0.4	25	18	3500	2500	1100		
ERZV10D201	200( 185- 225)	130	170	340	0.4	35	25	3500	2500	430		
ERZV10D221	220( 198- 242)	140	180	360	0.4	39	27.5	3500	2500	410		
ERZV10D241	240( 216- 264)	150	200	395	0.4	42	30	3500	2500	380		
ERZV10D271	270( 247- 303)	175	225	455	0.4	49	35	3500	2500	350		
ERZV10D331	330( 297- 363)	210	270	545	0.4	58	42	3500	2500	300		
ERZV10D361	360( 324- 396)	230	300	595	0.4	65	45	3500	2500	300		
ERZV10D391	390( 351- 429)	250	320	650	0.4	70	50	3500	2500	300		
ERZV10D431	430( 387- 473)	275	350	710	0.4	80	55	3500	2500	270		
ERZV10D471	470( 423- 517)	300	385	775	0.4	85	60	3500	2500	230		
ERZV10D511	510( 459- 561)	320	410	845	0.4	92	67	3500	2500	210		
ERZV10D621	620( 558- 682)	385	505	1025	0.4	92	67	3500	2500	190		
ERZV10D681	680( 612- 748)	420	560	1120	0.4	92	67	3500	2500	170		
ERZV10D751	750( 675- 825)	460	615	1240	0.4	100	70	3500	2500	160		
ERZV10D821	820( 738- 902)	510	670	1355	0.4	110	80	3500	2500	140		
ERZV10D911	910( 819-1001)	550	745	1500	0.4	130	90	3500	2500	120		
ERZV10D102	1000( 900-1100)	625	825	1650	0.4	140	100	3500	2500	110		
ERZV10D112	1100( 990-1210)	680	895	1815	0.4	155	110	3500	2500	110		
ERZV10D182CS	1800(1700-1980)	1000	1465	2970	0.4	247	183	3500	2500	70*		

\* Measured at 1 MHz

### ■ Dimensions in mm (not to scale)

#### ERZV10D180 to ERZV10D680

Part No.	D max.	T max.	W	H max.	L
ERZV10D180	11.5	4.6	7.5±1.0	14.5	1.3±1.0
ERZV10D220	11.5	4.7	7.5±1.0	14.5	1.4±1.0
ERZV10D270	11.5	4.8	7.5±1.0	14.5	1.5±1.0
ERZV10D330	11.5	5.0	7.5±1.0	14.5	1.7±1.0
ERZV10D390	11.5	4.9	7.5±1.0	14.5	1.6±1.0
ERZV10D470	11.5	5.0	7.5±1.0	14.5	1.7±1.0
ERZV10D560	11.5	5.1	7.5±1.0	14.5	1.8±1.0
ERZV10D680	11.5	5.3	7.5±1.0	14.5	2.0±1.0

#### ERZV10D820 to ERZV10D182CS

Part No.	D max.	T max.	W	H max.	L
ERZV10D820	11.5	4.5	7.5±1.0	14.5	1.6±1.0
ERZV10D101	11.5	4.7	7.5±1.0	14.5	1.8±1.0
ERZV10D121	11.5	4.9	7.5±1.0	14.5	2.0±1.0
ERZV10D151	11.5	5.2	7.5±1.0	14.5	2.3±1.0
ERZV10D201	11.5	4.8	7.5±1.0	14.5	1.9±1.0
ERZV10D221	11.5	4.9	7.5±1.0	14.5	2.0±1.0
ERZV10D241	11.5	5.0	7.5±1.0	14.5	2.1±1.0
ERZV10D271	11.5	5.2	7.5±1.0	14.5	2.3±1.0
ERZV10D331	11.5	5.5	7.5±1.0	14.5	2.6±1.0
ERZV10D361	11.5	5.7	7.5±1.0	14.5	2.8±1.0
ERZV10D391	11.5	5.8	7.5±1.0	14.5	2.9±1.0
ERZV10D431	11.5	6.0	7.5±1.0	14.5	3.1±1.0
ERZV10D471	11.5	6.2	7.5±1.0	14.5	3.3±1.0
ERZV10D511	11.5	6.4	7.5±1.0	14.5	3.5±1.0
ERZV10D621	12.5	7.1	7.5±1.0	15.5	4.2±1.0
ERZV10D681	12.5	7.4	7.5±1.0	15.5	4.5±1.0
ERZV10D751	12.5	7.8	7.5±1.0	15.5	4.9±1.0
ERZV10D821	12.5	8.1	7.5±1.0	15.5	5.2±1.0
ERZV10D911	12.5	8.6	7.5±1.0	15.5	5.7±1.0
ERZV10D102	12.5	9.1	7.5±1.0	15.5	6.2±1.0
ERZV10D112	12.5	9.7	7.5±1.0	15.5	6.8±1.0
ERZV10D182CS	13.5	14.4	11.0±1.0*	16.5	10.0±1.5

\*:  $W_2$

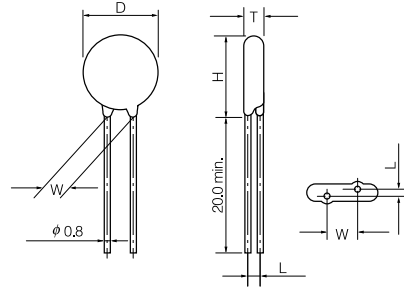

(ERZV10D182CS)

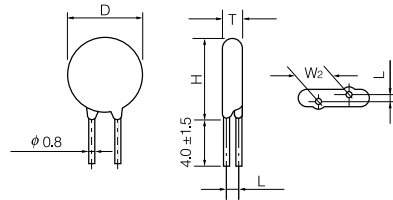

### ■ Typical Characteristics

#### Voltage vs. Current

(ERZV10D180 to ERZV10D680)

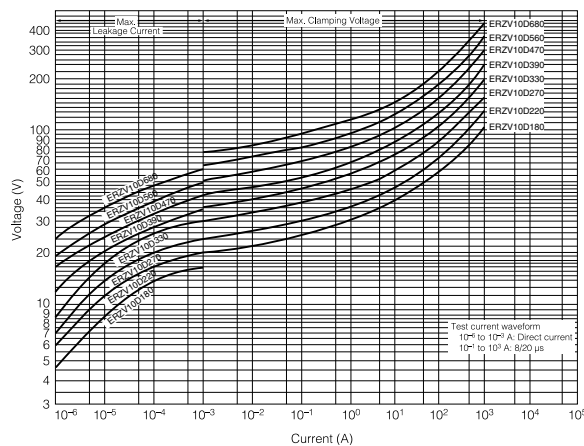

#### Impulse Derating

(Relation between impulse width and impulse repetition times)

(ERZV10D180 to ERZV10D680)

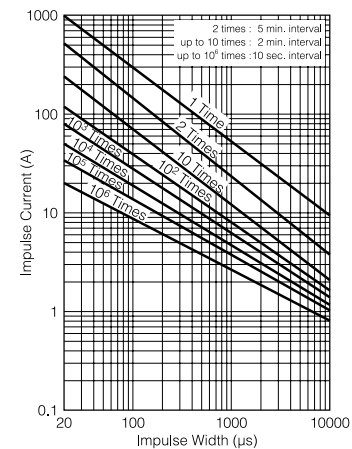

### ■ Typical Characteristics Voltage vs. Current

(ERZV10D820 to ERZV10D511)

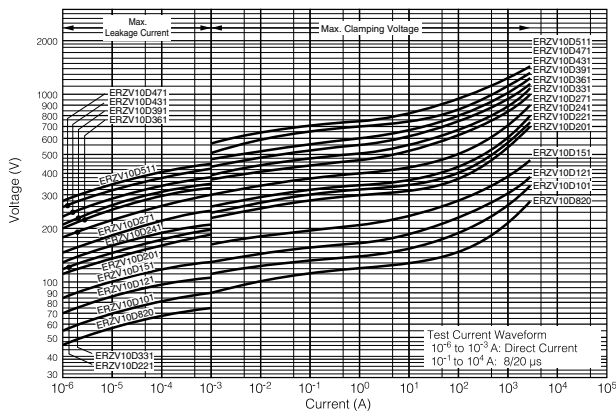

### Impulse Derating (Relation between impulse width and impulse repetition times)

(ERZV10D820 to ERZV10D511)

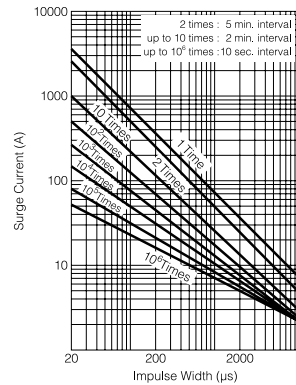

(ERZV10D621 to ERZV10D112)

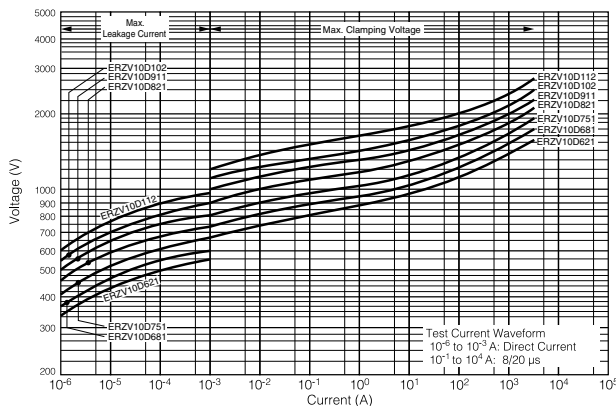

(ERZV10D621 to ERZV10D112)

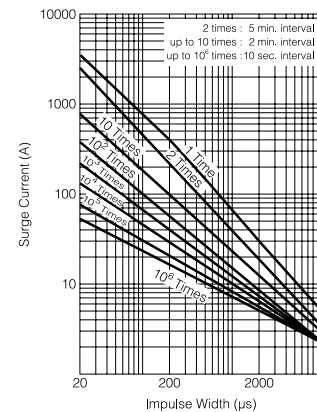

(ERZV10D182CS)

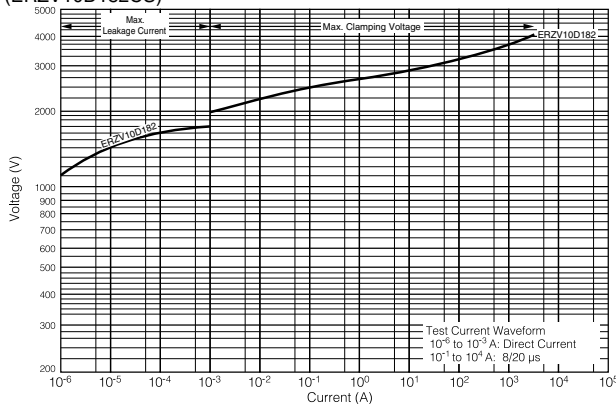

(ERZV10D182CS)

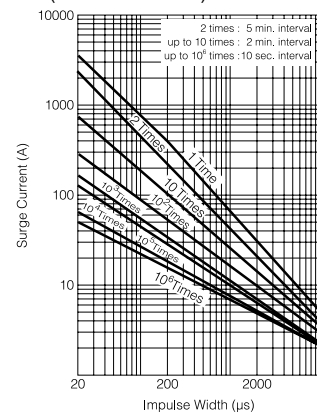

### 14 Series

#### ■ Ratings and Characteristics

- Operating Temperature Range : -40 to 85 °C
- Storage Temperature Range : -40 to 125 °C
- Temperature Coefficient of Varistor Voltage : 0 to -0.05 %/°C

#### ERZV14D180 to ERZV14D680

Part No.	Varistor Voltage	Maximum Allowable Voltage		Clamping Voltage (max.)	Rated Power	Maximum Energy		Maximum Peak Current (8/20 μs)		Capacitance (max.) @1 kHz (pF)
						(10/1000 μs)	(2 ms)	1 time	2 times	
						V <sub>1mA</sub> (V)	ACrms (V)	DC (V)	V <sub>10A</sub> (V)	
ERZV14D180	18 (16-20)	11	14	36	0.1	5.2	4.3	2000	1000	25000
ERZV14D220	22 (20-24)	14	18	43	0.1	6.3	5.3	2000	1000	20000
ERZV14D270	27 (24-30)	17	22	53	0.1	7.8	6.5	2000	1000	16000
ERZV14D330	33 (30-36)	20	26	65	0.1	9.5	7.9	2000	1000	12200
ERZV14D390	39 (35-43)	25	31	77	0.1	11	9.4	2000	1000	7000
ERZV14D470	47 (42-52)	30	38	93	0.1	14	11	2000	1000	6750
ERZV14D560	56 (50-62)	35	45	110	0.1	16	13	2000	1000	6500
ERZV14D680	68 (61-75)	40	56	135	0.1	20	16	2000	1000	5500

#### ERZV14D820 to ERZV14D182CS

Part No.	Varistor Voltage	Maximum Allowable Voltage		Clamping Voltage (max.)	Rated Power	Maximum Energy		Maximum Peak Current (8/20 μs)		Capacitance (max.) @1 kHz (pF)
						(10/1000 μs)	(2 ms)	1 time	2 times	
						V <sub>1mA</sub> (V)	ACrms (V)	DC (V)	V <sub>50A</sub> (V)	
ERZV14D820	82( 74- 90)	50	65	135	0.6	28	20	6000	5000	3700
ERZV14D101	100( 90- 110)	60	85	165	0.6	35	25	6000	5000	3200
ERZV14D121	120( 108- 132)	75	100	200	0.6	42	30	6000	5000	2700
ERZV14D151	150( 135- 165)	95	125	250	0.6	53	37.5	6000	5000	2200
ERZV14D201	200( 185- 225)	130	170	340	0.6	70	50	6000	5000	770
ERZV14D221	220( 198- 242)	140	180	360	0.6	78	55	6000	5000	740
ERZV14D241	240( 216- 264)	150	200	395	0.6	84	60	6000	5000	700
ERZV14D271	270( 247- 303)	175	225	455	0.6	99	70	6000	5000	640
ERZV14D331	330( 297- 363)	210	270	545	0.6	115	80	6000	4500	580
ERZV14D361	360( 324- 396)	230	300	595	0.6	130	90	6000	4500	540
ERZV14D391	390( 351- 429)	250	320	650	0.6	140	100	6000	4500	500
ERZV14D431	430( 387- 473)	275	350	710	0.6	155	110	6000	4500	450
ERZV14D471	470( 423- 517)	300	385	775	0.6	175	125	6000	4500	400
ERZV14D511	510( 459- 561)	320	410	845	0.6	190	136	6000	4500	350
ERZV14D621	620( 558- 682)	385	505	1025	0.6	190	136	5000	4500	330
ERZV14D681	680( 612- 748)	420	560	1120	0.6	190	136	5000	4500	320
ERZV14D751	750( 675- 825)	460	615	1240	0.6	210	150	5000	4500	310
ERZV14D821	820( 738- 902)	510	670	1355	0.6	235	165	5000	4500	280
ERZV14D911	910( 819-1001)	550	745	1500	0.6	255	180	5000	4500	250
ERZV14D102	1000( 900-1100)	625	825	1650	0.6	280	200	5000	4500	230
ERZV14D112	1100( 990-1210)	680	895	1815	0.6	310	220	5000	4500	210
ERZV14D182CS	1800(1700-1980)	1000	1465	2970	0.6	510	360	5000	4500	120

### ■ Dimensions in mm (not to scale)

#### ERZV14D180 to ERZV14D680

Part No.	D max.	T max.	W	H max.	L
ERZV14D180	15.5	4.6	7.5±1.0	18.5	1.3±1.0
ERZV14D220	15.5	4.7	7.5±1.0	18.5	1.4±1.0
ERZV14D270	15.5	4.8	7.5±1.0	18.5	1.5±1.0
ERZV14D330	15.5	5.0	7.5±1.0	18.5	1.7±1.0
ERZV14D390	15.5	4.9	7.5±1.0	18.5	1.6±1.0
ERZV14D470	15.5	5.0	7.5±1.0	18.5	1.7±1.0
ERZV14D560	15.5	5.1	7.5±1.0	18.5	1.8±1.0
ERZV14D680	15.5	5.3	7.5±1.0	18.5	2.0±1.0

#### ERZV14D820 to ERZV14D182CS

Part No.	D max.	T max.	W	H max.	L
ERZV14D820	15.5	4.5	7.5±1.0	18.5	1.6±1.0
ERZV14D101	15.5	4.7	7.5±1.0	18.5	1.8±1.0
ERZV14D121	15.5	4.9	7.5±1.0	18.5	2.0±1.0
ERZV14D151	15.5	5.2	7.5±1.0	18.5	2.3±1.0
ERZV14D201	15.5	4.8	7.5±1.0	18.5	1.9±1.0
ERZV14D221	15.5	4.9	7.5±1.0	18.5	2.0±1.0
ERZV14D241	15.5	5.0	7.5±1.0	18.5	2.1±1.0
ERZV14D271	15.5	5.2	7.5±1.0	18.5	2.3±1.0
ERZV14D331	15.5	5.5	7.5±1.0	18.5	2.6±1.0
ERZV14D361	15.5	5.7	7.5±1.0	18.5	2.8±1.0
ERZV14D391	15.5	5.8	7.5±1.0	18.5	2.9±1.0
ERZV14D431	15.5	6.0	7.5±1.0	18.5	3.1±1.0
ERZV14D471	15.5	6.2	7.5±1.0	18.5	3.3±1.0
ERZV14D511	15.5	6.4	7.5±1.0	18.5	3.5±1.0
ERZV14D621	16.0	7.1	7.5±1.0	19.0	4.2±1.0
ERZV14D681	16.0	7.4	7.5±1.0	19.0	4.5±1.0
ERZV14D751	16.0	7.8	7.5±1.0	19.0	4.9±1.0
ERZV14D821	16.0	8.1	7.5±1.0	19.0	5.2±1.0
ERZV14D911	16.0	8.6	7.5±1.0	19.0	5.7±1.0
ERZV14D102	16.0	9.1	7.5±1.0	19.0	6.2±1.0
ERZV14D112	16.0	9.7	7.5±1.0	19.0	6.8±1.0
ERZV14D182CS	17.0	14.4	15.0±1.0*	20.5	10.5±2.0

\*: W<sub>2</sub>

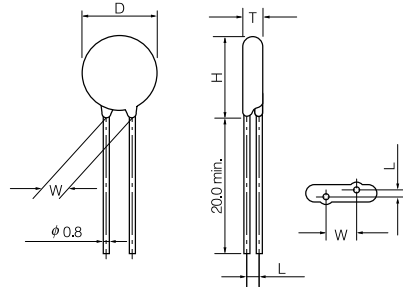

#### (ERZV14D182CS)

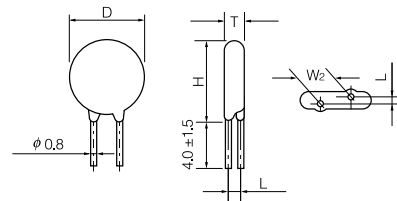

### ■ Typical Characteristics

#### Voltage vs. Current

(ERZV14D180 to ERZV14D680)

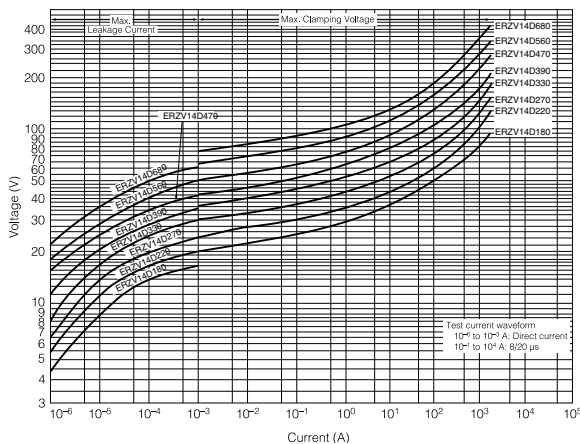

#### Impulse Derating (Relation between impulse

width and impulse repetition times)

(ERZV14D180 to ERZV14D680)

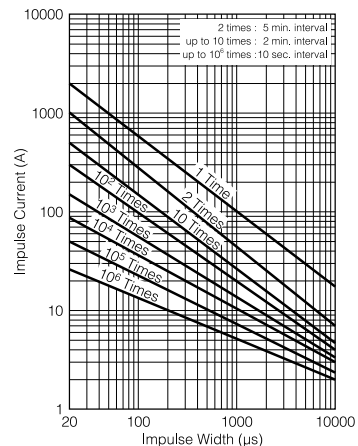

## Typical Characteristics Voltage vs. Current

(ERZV14D820 to ERZV14D511)

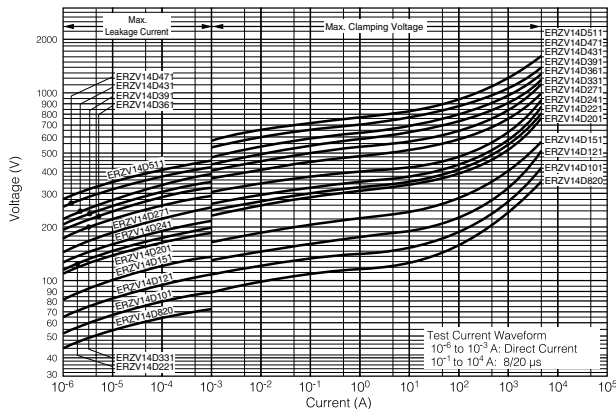

## Impulse Derating (Relation between impulse width and impulse current)

(ERZV14D820 to ERZV14D511)

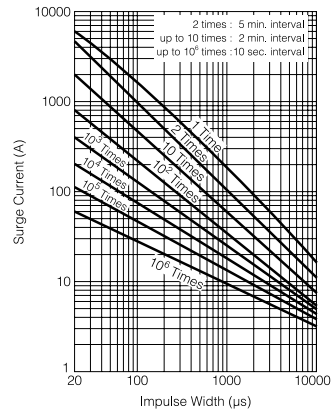

(ERZV14D621 to ERZV14D112)

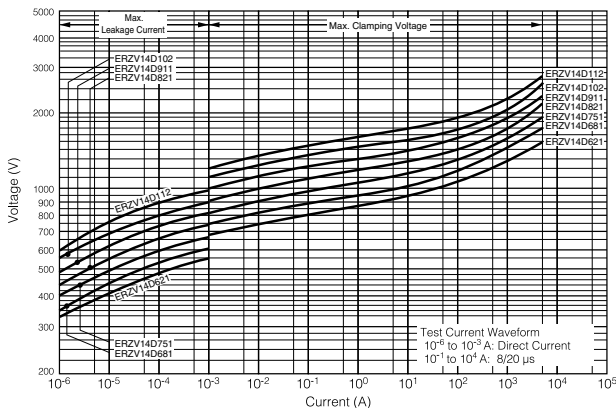

(ERZV14D621 to ERZV14D112)

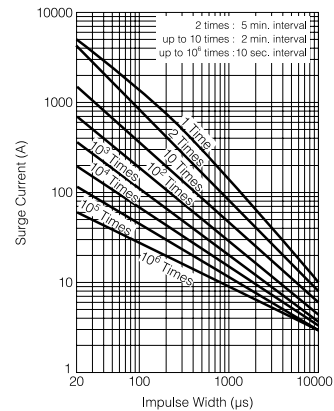

(ERZV14D182CS)

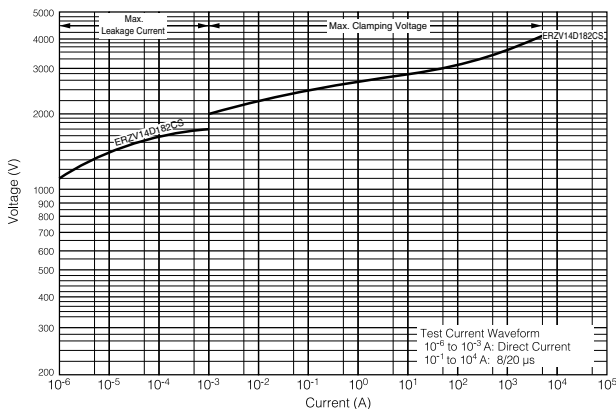

(ERZV14D182CS)

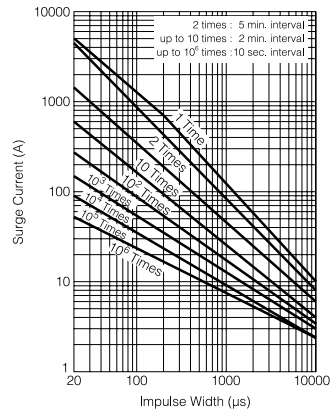



### 20 Series

#### ■ Ratings and Characteristics

- Operating Temperature Range : -40 to 85 °C
- Storage Temperature Range : -40 to 125 °C
- Temperature Coefficient of Varistor Voltage : 0 to -0.05 %/°C

#### ERZV20D180 to ERZV20D680

Part No.	Varistor Voltage	Maximum Allowable Voltage		Clamping Voltage (max.)	Rated Power	Maximum Energy		Maximum Peak Current (8/20 μs)		Capacitance (max.) @1 kHz (pF)
						(10/1000 μs)	(2 ms)	1 time	2 times	
						V <sub>1mA</sub> (V)	ACrms (V)	DC (V)	V <sub>20A</sub> (V)	
ERZV20D180	18 (16-20)	11	14	36	0.2	13	12	3000	2000	40000
ERZV20D220	22 (20-24)	14	18	43	0.2	16	14	3000	2000	30000
ERZV20D270	27 (24-30)	17	22	53	0.2	19	17	3000	2000	24500
ERZV20D330	33 (30-36)	20	26	65	0.2	24	21	3000	2000	20000
ERZV20D390	39 (35-43)	25	31	77	0.2	28	25	3000	2000	13800
ERZV20D470	47 (42-52)	30	38	93	0.2	34	30	3000	2000	13500
ERZV20D560	56 (50-62)	35	45	110	0.2	41	36	3000	2000	12200
ERZV20D680	68 (61-75)	40	56	135	0.2	49	44	3000	2000	11500

#### ERZV20D820 to ERZV20D182

Part No.	Varistor Voltage	Maximum Allowable Voltage		Clamping Voltage (max.)	Rated Power	Maximum Energy		Maximum Peak Current (8/20 μs)		Capacitance (max.) @1 kHz (pF)
						(10/1000 μs)	(2 ms)	1 time	2 times	
						V <sub>1mA</sub> (V)	ACrms (V)	DC (V)	V <sub>100A</sub> (V)	
ERZV20D820	82( 74- 90)	50	65	135	1.0	56	40	10000	7000	7500
ERZV20D101	100( 90- 110)	60	85	165	1.0	70	50	10000	7000	6500
ERZV20D121	120( 108- 132)	75	100	200	1.0	85	60	10000	7000	5500
ERZV20D151	150( 135- 165)	95	125	250	1.0	106	75	10000	7000	4500
ERZV20D201	200( 185- 225)	130	170	340	1.0	140	100	10000	7000	1700
ERZV20D221	220( 198- 242)	140	180	360	1.0	155	110	10000	7000	1600
ERZV20D241	240( 216- 264)	150	200	395	1.0	168	120	10000	7000	1500
ERZV20D271	270( 247- 303)	175	225	455	1.0	190	135	10000	7000	1300
ERZV20D331	330( 297- 363)	210	270	545	1.0	228	160	10000	6500	1100
ERZV20D361	360( 324- 396)	230	300	595	1.0	255	180	10000	6500	1100
ERZV20D391	390( 351- 429)	250	320	650	1.0	275	195	10000	6500	1100
ERZV20D431	430( 387- 473)	275	350	710	1.0	303	215	10000	6500	1000
ERZV20D471	470( 423- 517)	300	385	775	1.0	350	250	10000	6500	900
ERZV20D511	510( 459- 561)	320	410	845	1.0	382	273	10000	6500	800
ERZV20D621	620( 558- 682)	385	505	1025	1.0	382	273	7500	6500	700
ERZV20D681	680( 612- 748)	420	560	1120	1.0	382	273	7500	6500	650
ERZV20D751	750( 675- 825)	460	615	1240	1.0	420	300	7500	6500	600
ERZV20D821	820( 738- 902)	510	670	1355	1.0	460	325	7500	6500	530
ERZV20D911	910( 819-1001)	550	745	1500	1.0	510	360	7500	6500	500
ERZV20D102	1000( 900-1100)	625	825	1650	1.0	565	400	7500	6500	450
ERZV20D112	1100( 990-1210)	680	895	1815	1.0	620	440	7500	6500	400
ERZV20D182	1800(1700-1980)	1000	1465	2970	1.0	1020	720	7500	6500	250

### ■ Dimensions in mm (not to scale)

#### ERZV20D180 to ERZV20D680

Part No.	D max.	T max.	W	H max.	L
ERZV20D180	21.5	5.1	10.0±1.0	24.5	1.5±1.0
ERZV20D220	21.5	5.2	10.0±1.0	24.5	1.6±1.0
ERZV20D270	21.5	5.3	10.0±1.0	24.5	1.7±1.0
ERZV20D330	21.5	5.5	10.0±1.0	24.5	1.9±1.0
ERZV20D390	21.5	5.5	10.0±1.0	24.5	1.9±1.0
ERZV20D470	21.5	5.6	10.0±1.0	24.5	2.0±1.0
ERZV20D560	21.5	5.7	10.0±1.0	24.5	2.1±1.0
ERZV20D680	21.5	5.8	10.0±1.0	24.5	2.2±1.0

#### ERZV20D820 to ERZV20D182CS

Part No.	D max.	T max.	W	H max.	L
ERZV20D820	21.5	4.9	10.0±1.0	24.5	1.8±1.0
ERZV20D101	21.5	5.1	10.0±1.0	24.5	2.0±1.0
ERZV20D121	21.5	5.3	10.0±1.0	24.5	2.2±1.0
ERZV20D151	21.5	5.6	10.0±1.0	24.5	2.5±1.0
ERZV20D201	21.5	5.2	10.0±1.0	24.5	2.1±1.0
ERZV20D221	21.5	5.3	10.0±1.0	24.5	2.2±1.0
ERZV20D241	21.5	5.4	10.0±1.0	24.5	2.3±1.0
ERZV20D271	21.5	5.6	10.0±1.0	24.5	2.5±1.0
ERZV20D331	21.5	5.9	10.0±1.0	24.5	2.8±1.0
ERZV20D361	21.5	6.1	10.0±1.0	24.5	3.0±1.0
ERZV20D391	21.5	6.2	10.0±1.0	24.5	3.1±1.0
ERZV20D431	21.5	6.4	10.0±1.0	24.5	3.3±1.0
ERZV20D471	21.5	6.6	10.0±1.0	24.5	3.5±1.0
ERZV20D511	21.5	6.8	10.0±1.0	24.5	3.7±1.0
ERZV20D621	22.5	7.5	10.0±1.0	25.5	4.4±1.0
ERZV20D681	22.5	7.8	10.0±1.0	25.5	4.7±1.0
ERZV20D751	22.5	8.2	10.0±1.0	25.5	5.1±1.0
ERZV20D821	22.5	8.5	10.0±1.0	25.5	5.4±1.0
ERZV20D911	22.5	9.0	10.0±1.0	25.5	5.9±1.0
ERZV20D102	22.5	9.5	10.0±1.0	25.5	6.4±1.0
ERZV20D112	22.5	10.1	10.0±1.0	25.5	7.0±1.0
ERZV20D182	23.5	14.8	15.0±1.0*	28.0	10.7±2.0

\*:  $W_2$

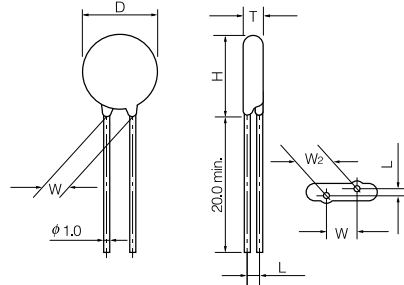

### ■ Typical Characteristics Voltage vs. Current

(ERZV20D180 to ERZV20D680)

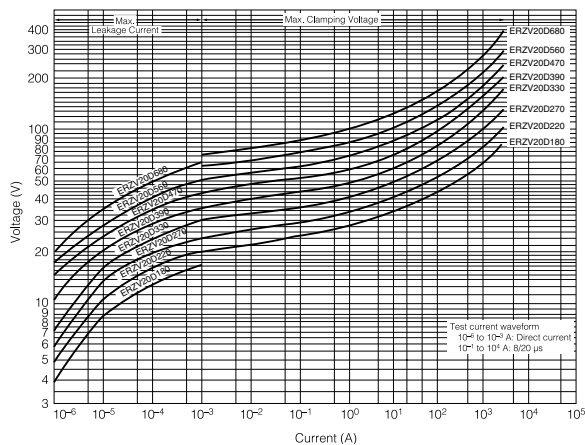

### Impulse Derating (Relation between impulse width and impulse repetition times)

(ERZV20D180 to ERZV20D680)

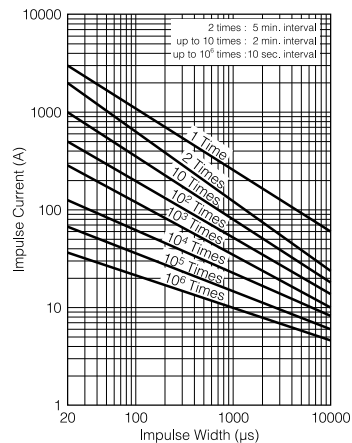

## Typical Characteristics Voltage vs. Current

(ERZV20D820 to ERZV20D511)

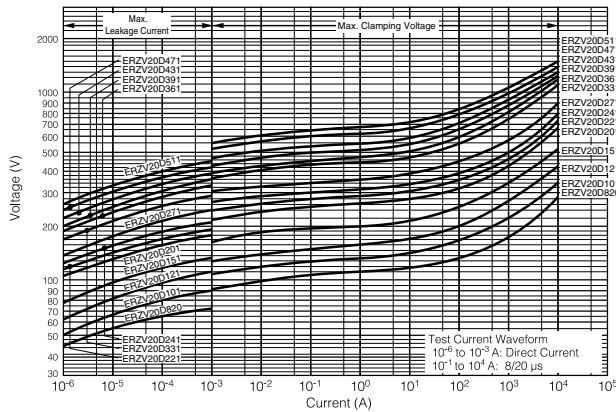

(ERZV20D621 to ERZV20D112)

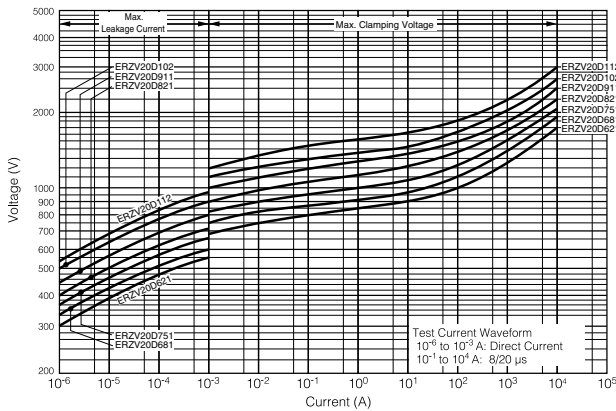

(ERZV20D182)

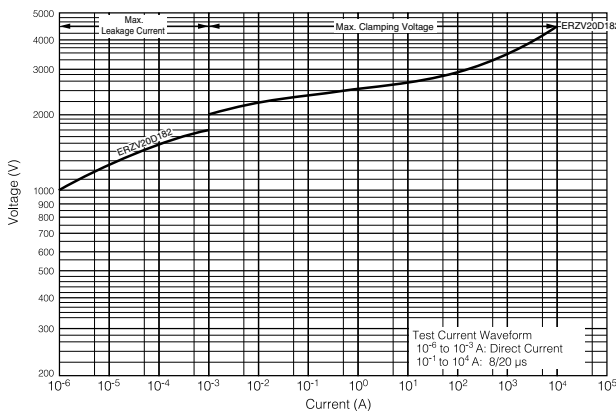

## Impulse Derating (Relation between impulse width and impulse repetition times)

(ERZV20D820 to ERZV20D511)

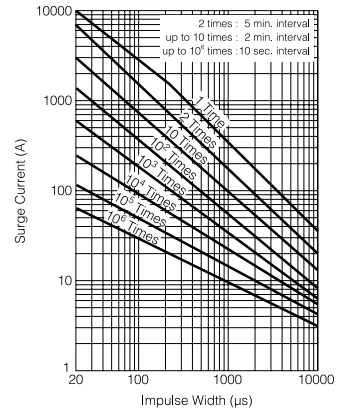

(ERZV20D621 to ERZV20D112)

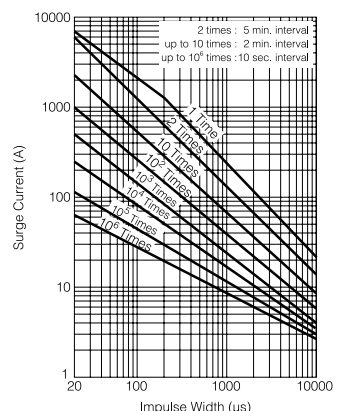

(ERZV20D182)

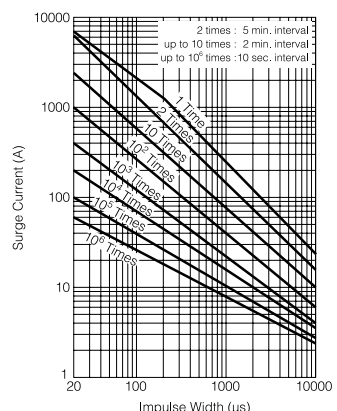

### Straight Leads Cut Type (Bulk Type)

#### ■ Ratings and Characteristics

\* Refer to bulk standard type part no. (P20-P34).

#### ■ Dimensions in mm (not to scale)

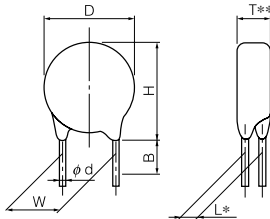

notes \* Dimension "L": Conforms to each individual specification.  
 \*\* Dimension "T": Conforms to each individual specification.

Series Varistor Voltage Symbol	5 Series	7 Series	9 Series	10 Series		14 Series			
D	180 to 471	180 to 511	180 to 511	180 to 511	621 to 751	821 to 112	180 to 511	621 to 751	821 to 112
D	7.0 max.	8.5 max.	11.5 max.	11.5 max.	12.5 max.	12.5 max.	15.5 max.	16.0 max.	16.0 max.
H	10.0 max.	11.5 max.	14.0 max.	14.5 max.	15.5 max.	15.5 max.	18.5 max.	19.0 max.	19.0 max.
W	5.0±1.0	5.0±1.0	5.0±1.0	7.5±1.0	7.5±1.0	7.5±1.0	7.5±1.0	7.5±1.0	7.5±1.0
φd	0.60 <sup>+0.06</sup> <sub>-0.05</sub>	0.60 <sup>+0.06</sup> <sub>-0.05</sub>	0.60 <sup>+0.06</sup> <sub>-0.05</sub>	0.80 <sup>+0.08</sup> <sub>-0.05</sub>	0.80 <sup>+0.08</sup> <sub>-0.05</sub>	0.80 <sup>+0.08</sup> <sub>-0.05</sub>	0.80 <sup>+0.08</sup> <sub>-0.05</sub>	0.80 <sup>+0.08</sup> <sub>-0.05</sub>	0.80 <sup>+0.08</sup> <sub>-0.05</sub>
B	4.0±1.0	4.0±1.0	4.0±1.0	4.0±1.0	4.0±1.0	4.0±1.5	4.0±1.0	4.0±1.0	4.0±1.5
Standard Products Part No.	ERZV05D□□□CS	ERZV07D□□□CS	ERZV09D□□□CS	ERZV10D□□□CS	ERZV10D□□□CS	ERZV10D□□□C1	ERZV14D□□□CS	ERZV14D□□□CS	ERZV14D□□□C1

### Crimped Leads Cut Type (Bulk Type)

#### ■ Ratings and Characteristics

\* Refer to bulk standard type part no. (P20-P34).

#### ■ Dimensions in mm (not to scale)

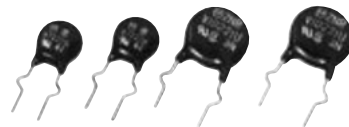
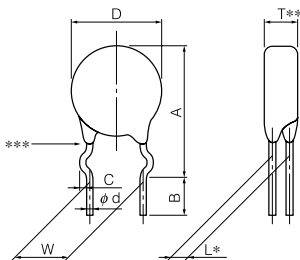

notes \* Dimension "L": Conforms to each individual specification.  
 \*\* Dimension "T": Conforms to each individual specification.  
 \*\*\* Resin extensions : No resin below center of the hook.

Series Varistor Voltage Symbol	5 Series	7 Series	9 Series	10 Series		14 Series			
A	180 to 471	180 to 511	180 to 511	180 to 511	621 to 751	821 to 112	180 to 511	621 to 751	821 to 112
A	13.0 max.	14.5 max.	17.5 max.	17.5 max.	19.0 max.	20.0 max.	21.0 max.	22.0 max.	23.5 max.
D	7.0 max.	8.5 max.	11.5 max.	11.5 max.	12.5 max.	12.5 max.	15.5 max.	16.0 max.	16.0 max.
C	1.2±0.4	1.2±0.4	1.2±0.4	1.4±0.4	1.4±0.4	1.4±0.4	1.4±0.4	1.4±0.4	1.4±0.4
W	5.0±1.0	5.0±1.0	5.0±1.0	7.5±1.0	7.5±1.0	7.5±1.0	7.5±1.0	7.5±1.0	7.5±1.0
φd	0.60 <sup>+0.06</sup> <sub>-0.05</sub>	0.60 <sup>+0.06</sup> <sub>-0.05</sub>	0.60 <sup>+0.06</sup> <sub>-0.05</sub>	0.80 <sup>+0.08</sup> <sub>-0.05</sub>	0.80 <sup>+0.08</sup> <sub>-0.05</sub>	0.80 <sup>+0.08</sup> <sub>-0.05</sub>	0.80 <sup>+0.08</sup> <sub>-0.05</sub>	0.80 <sup>+0.08</sup> <sub>-0.05</sub>	0.80 <sup>+0.08</sup> <sub>-0.05</sub>
B	4.0±1.0	4.0±1.0	4.0±1.0	4.0±1.0	4.0±1.0	4.0±1.5	4.0±1.0	4.0±1.0	4.0±1.5
Standard Products Part No.	ERZV05V□□□CS	ERZV07V□□□CS	ERZV09V□□□CS	ERZV10V□□□CS	ERZV10V□□□CS	ERZV10V□□□C1	ERZV14V□□□CS	ERZV14V□□□CS	ERZV14V□□□C1

### Taping Specifications for Automated Assembly (Straight Leads and Taping)

#### ■ Ratings and Characteristics

\* Refer to bulk standard type part no. (P20-P34).

#### ■ Taping Dimensions in mm (not to scale)

Type I-II

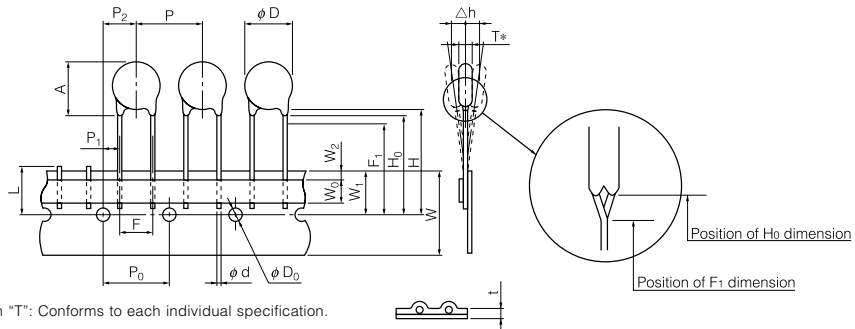

\* Dimension "T": Conforms to each individual specification.

Type III-IV

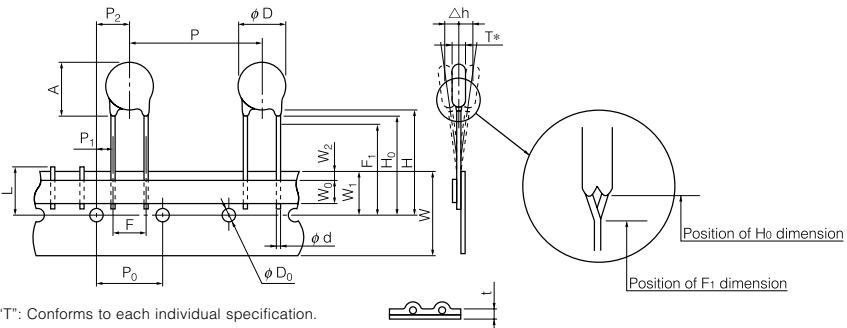

\* Dimension "T": Conforms to each individual specification.

Series	5 Series	7 Series	9 Series	10 Series			14 Series		
Varistor Voltage	180 to 471	180 to 511	180 to 511	180 to 331	361 to 511	621 to 112	180 to 331	361 to 511	621 to 112
Symbol	Type I	Type I	Type I	Type I	Type II	Type II	Type III	Type IV	Type IV
P	12.7±1.0	12.7±1.0	12.7±1.0	15.0±1.0	15.0±1.0	15.0±1.0	30.0±1.0	30.0±1.0	30.0±1.0
P <sub>0</sub>	12.7±0.3	12.7±0.3	12.7±0.3	15.0±0.3	15.0±0.3	15.0±0.3	15.0±0.3	15.0±0.3	15.0±0.3
P <sub>1</sub>	3.85±0.70	3.85±0.70	3.85±0.70	3.75±0.70	3.75±0.70	3.75±0.70	3.75±0.70	3.75±0.70	3.75±0.70
P <sub>2</sub>	6.35±1.30	6.35±1.30	6.35±1.30	7.5±1.3	7.5±1.3	7.5±1.3	7.5±1.3	7.5±1.3	7.5±1.3
φ d	0.60 <sup>+0.06</sup> <sub>-0.05</sub>	0.60 <sup>+0.06</sup> <sub>-0.05</sub>	0.60 <sup>+0.06</sup> <sub>-0.05</sub>	0.80 <sup>+0.08</sup> <sub>-0.05</sub>	0.80 <sup>+0.08</sup> <sub>-0.05</sub>	0.80 <sup>+0.08</sup> <sub>-0.05</sub>	0.80 <sup>+0.08</sup> <sub>-0.05</sub>	0.80 <sup>+0.08</sup> <sub>-0.05</sub>	0.80 <sup>+0.08</sup> <sub>-0.05</sub>
F	5.0±0.5	5.0±0.5	5.0±0.5	7.5±0.5	7.5±0.5	7.5±0.5	7.5±0.5	7.5±0.5	7.5±0.5
Δ h	0±2	0±2	0±2	0±2	0±2	0±2	0±2	0±2	0±2
W	18.0 <sup>+1.0</sup> <sub>-0.5</sub>	18.0 <sup>+1.0</sup> <sub>-0.5</sub>	18.0 <sup>+1.0</sup> <sub>-0.5</sub>	18.0 <sup>+1.0</sup> <sub>-0.5</sub>	18.0 <sup>+1.0</sup> <sub>-0.5</sub>	18.0 <sup>+1.0</sup> <sub>-0.5</sub>	18.0 <sup>+1.0</sup> <sub>-0.5</sub>	18.0 <sup>+1.0</sup> <sub>-0.5</sub>	18.0 <sup>+1.0</sup> <sub>-0.5</sub>
W <sub>0</sub>	5.0 min.	5.0 min.	5.0 min.	5.0 min.	5.0 min.	5.0 min.	5.0 min.	5.0 min.	5.0 min.
W <sub>1</sub>	9.0±0.5	9.0±0.5	9.0±0.5	9.0±0.5	9.0±0.5	9.0±0.5	9.0±0.5	9.0±0.5	9.0±0.5
W <sub>2</sub>	3 max.	3 max.	3 max.	3 max.	3 max.	3 max.	3 max.	3 max.	3 max.
H	Approx. 22	Approx. 22	Approx. 22	Approx. 22	Approx. 22	Approx. 22	Approx. 22	Approx. 22	Approx. 22
H <sub>0</sub>	17.0±0.5	17.0±0.5	17.0±0.5	18.0 <sup>+2.0</sup> <sub>-0.5</sub>	—	—	18.0 <sup>+2.0</sup> <sub>-0.5</sub>	—	—
F <sub>1</sub>	—	—	—	—	16.00 <sup>+0.75</sup> <sub>-0.5</sub>	16.00 <sup>+0.75</sup> <sub>-0.5</sub>	—	16.00 <sup>+0.75</sup> <sub>-0.5</sub>	16.00 <sup>+0.75</sup> <sub>-0.5</sub>
φ D	φ 4.0±0.2	φ 4.0±0.2	φ 4.0±0.2	φ 4.0±0.2	φ 4.0±0.2	φ 4.0±0.2	φ 4.0±0.2	φ 4.0±0.2	φ 4.0±0.2
t	0.6±0.3	0.6±0.3	0.6±0.3	0.6±0.3	0.6±0.3	0.6±0.3	0.6±0.3	0.6±0.3	0.6±0.3
L	11 max.	11 max.	11 max.	11 max.	11 max.	11 max.	11 max.	11 max.	11 max.
φ D	7.0 max.	8.5 max.	11.5 max.	11.5 max.	11.5 max.	12.5 max.	15.5 max.	15.5 max.	16.0 max.
A	10.0 max.	11.5 max.	14.0 max.	14.5 max.	14.5 max.	15.5 max.	18.5 max.	18.5 max.	19.0 max.
Standard Products Part No.	ERZVA5D□□□	ERZVA7D□□□	ERZVA9D□□□	ERZVGAD□□□	ERZVGAD□□□	ERZVGAD□□□	ERZVGED□□□	ERZVGED□□□	ERZVGED□□□

Design and specifications are subject to change without notice. Ask factory for technical specifications before purchase and/or use.  
Whenever a doubt about safety arises from this product, please contact us immediately for technical consultation.

### Taping Specifications for Automated Assembly (Crimped Leads and Taping)

#### ■ Ratings and Characteristics

\* Refer to bulk standard type part no. (P20-P34).

#### ■ Taping Dimensions in mm (not to scale)

##### Type I

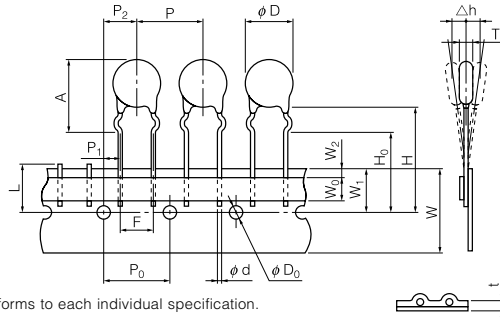

\* Dimension "T": Conforms to each individual specification.

##### Type II

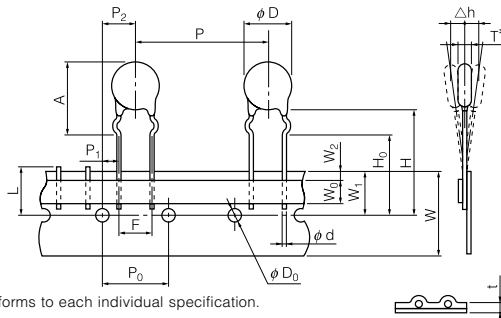

\* Dimension "T": Conforms to each individual specification.

Series Varistor Voltage	5 Series	7 Series	9 Series	10 Series			14 Series		
Symbol	Type I	Type I	Type I	Type I	Type I	Type I	Type II	Type II	Type II
P	12.7±1.0	12.7±1.0	12.7±1.0	15.0±1.0	15.0±1.0	15.0±1.0	30.0±1.0	30.0±1.0	30.0±1.0
P <sub>0</sub>	12.7±0.3	12.7±0.3	12.7±0.3	15.0±0.3	15.0±0.3	15.0±0.3	15.0±0.3	15.0±0.3	15.0±0.3
P <sub>1</sub>	3.85±0.70	3.85±0.70	3.85±0.70	3.75±0.70	3.75±0.70	3.75±0.70	3.75±0.70	3.75±0.70	3.75±0.70
P <sub>2</sub>	6.35±1.30	6.35±1.30	6.35±1.30	7.5±1.3	7.5±1.3	7.5±1.3	7.5±1.3	7.5±1.3	7.5±1.3
ϕ d	0.60 <sup>+0.06</sup> <sub>-0.05</sub>	0.60 <sup>+0.06</sup> <sub>-0.05</sub>	0.60 <sup>+0.06</sup> <sub>-0.05</sub>	0.80 <sup>+0.08</sup> <sub>-0.05</sub>	0.80 <sup>+0.08</sup> <sub>-0.05</sub>	0.80 <sup>+0.08</sup> <sub>-0.05</sub>	0.80 <sup>+0.08</sup> <sub>-0.05</sub>	0.80 <sup>+0.08</sup> <sub>-0.05</sub>	0.80 <sup>+0.08</sup> <sub>-0.05</sub>
F	5.0±0.5	5.0±0.5	5.0±0.5	7.5±0.5	7.5±0.5	7.5±0.5	7.5±0.5	7.5±0.5	7.5±0.5
Δ h	0±2	0±2	0±2	0±2	0±2	0±2	0±2	0±2	0±2
W	18.0 <sup>+1.0</sup> <sub>-0.5</sub>	18.0 <sup>+1.0</sup> <sub>-0.5</sub>	18.0 <sup>+1.0</sup> <sub>-0.5</sub>	18.0 <sup>+1.0</sup> <sub>-0.5</sub>	18.0 <sup>+1.0</sup> <sub>-0.5</sub>	18.0 <sup>+1.0</sup> <sub>-0.5</sub>	18.0 <sup>+1.0</sup> <sub>-0.5</sub>	18.0 <sup>+1.0</sup> <sub>-0.5</sub>	18.0 <sup>+1.0</sup> <sub>-0.5</sub>
W <sub>0</sub>	5.0 min.	5.0 min.	5.0 min.	5.0 min.	5.0 min.	5.0 min.	5.0 min.	5.0 min.	5.0 min.
W <sub>1</sub>	9.0±0.5	9.0±0.5	9.0±0.5	9.0±0.5	9.0±0.5	9.0±0.5	9.0±0.5	9.0±0.5	9.0±0.5
W <sub>2</sub>	3 max.	3 max.	3 max.	3 max.	3 max.	3 max.	3 max.	3 max.	3 max.
H	Approx. 22	Approx. 22	Approx. 22	Approx. 22	Approx. 22	Approx. 22	Approx. 22	Approx. 22	Approx. 22
H <sub>0</sub>	17.0±0.5	17.0±0.5	17.0±0.5	16.0±0.5	16.0±0.5	16.0±0.5	16.0±0.5	16.0±0.5	16.0±0.5
ϕ D	ϕ4.0±0.2	ϕ4.0±0.2	ϕ4.0±0.2	ϕ4.0±0.2	ϕ4.0±0.2	ϕ4.0±0.2	ϕ4.0±0.2	ϕ4.0±0.2	ϕ4.0±0.2
t	0.6±0.3	0.6±0.3	0.6±0.3	0.6±0.3	0.6±0.3	0.6±0.3	0.6±0.3	0.6±0.3	0.6±0.3
L	11 max.	11 max.	11 max.	11 max.	11 max.	11 max.	11 max.	11 max.	11 max.
ϕ D	7.0 max.	8.5 max.	11.5 max.	11.5 max.	11.5 max.	12.5 max.	15.5 max.	15.5 max.	16.0 max.
A	13.0 max.	14.5 max.	17.5 max.	17.5 max.	17.5 max.	* (refer)	21.0 max.	21.0 max.	* (refer)
Standard Products Part No.	ERZVA5V□□□	ERZVA7V□□□	ERZVA9V□□□	ERZVEAV□□□	ERZVEAV□□□	ERZVEAV□□□	ERZVEEV□□□	ERZVEEV□□□	ERZVEEV□□□

\* Dimension "A"

	10 Series	14 Series		10 Series	14 Series
ERZV□□V621	19.0 max.	22.0 max.	ERZV□□V911	20.0 max.	23.5 max.
ERZV□□V681	19.0 max.	22.0 max.	ERZV□□V102	20.0 max.	23.5 max.
ERZV□□V751	19.0 max.	22.0 max.	ERZV□□V112	20.0 max.	23.5 max.
ERZV□□V821	20.0 max.	23.5 max.			

### Application Note for UL, CSA and VDE Recognized Components

Note: Register " Standard Registration No." when registering as the safe standard part, because it isn't registered in "Panasonic Part No."  
Please contact us about VDE certification

#### ■ Related Standards

Standard No. (Application Standard)	Category	Title	File No.	Varistor Voltage Range
<b>UL1414</b>	FOWX2	Across-The-Line, Antenna Coupling, and Line-By-Pass Capacitors for Radio and Television-Type Appliances	E62674 Vol.5, 10	5 Series 200 to 470 7 Series 200 to 510 9 Series 200 to 510 10 Series 200 to 1800 14 Series 200 to 1800 20 Series 200 to 1800
<b>UL1449</b>	XUHT2	Transient Voltage Surge Suppressors	E86821 Vol.1	5 Series 82 to 470 7 Series 82 to 510 9 Series 82 to 510 10 Series 82 to 1800 14 Series 82 to 1800 20 Series 82 to 1800
<b>CSA C22.2 No.1 Class 2221 01</b>	—	Accessories and Parts for Electronic Products ● Varistor for Across-The-Line use as transient protection on 120 Vac nominal system	LR-92226	5 Series 200 to 470 7 Series 200 to 510 9 Series 200 to 510 10 Series 200 to 1800 14 Series 200 to 1800 20 Series 200 to 1800

Note: For UL497B recognized ZNRs, contact our sales office or factory.

#### ■ Standard Registration No.\* and Standard Part No. Please contact us about VDE certification

Standard Registration No.*	Panasonic Part No.				
V*820U	ERZV□□D820	ERZV□□V820	ERZV○○D820	ERZV○○V820	(5,7,9,10,14,20 Series)
V*101U	ERZV□□D101	ERZV□□V101	ERZV○○D101	ERZV○○V101	(5,7,9,10,14,20 Series)
V*121U	ERZV□□D121	ERZV□□V121	ERZV○○D121	ERZV○○V121	(5,7,9,10,14,20 Series)
V*151U	ERZV□□D151	ERZV□□V151	ERZV○○D151	ERZV○○V151	(5,7,9,10,14,20 Series)
V*201U	ERZV□□D201	ERZV□□V201	ERZV○○D201	ERZV○○V201	(5,7,9,10,14,20 Series)
V*221U	ERZV□□D221	ERZV□□V221	ERZV○○D221	ERZV○○V221	(5,7,9,10,14,20 Series)
V*241U	ERZV□□D241	ERZV□□V241	ERZV○○D241	ERZV○○V241	(5,7,9,10,14,20 Series)
V*271U	ERZV□□D271	ERZV□□V271	ERZV○○D271	ERZV○○V271	(5,7,9,10,14,20 Series)
V*331U	ERZV□□D331	ERZV□□V331	ERZV○○D331	ERZV○○V331	(5,7,9,10,14,20 Series)
V*361U	ERZV□□D361	ERZV□□V361	ERZV○○D361	ERZV○○V361	(5,7,9,10,14,20 Series)
V*391U	ERZV□□D391	ERZV□□V391	ERZV○○D391	ERZV○○V391	(5,7,9,10,14,20 Series)
V*431U	ERZV□□D431	ERZV□□V431	ERZV○○D431	ERZV○○V431	(5,7,9,10,14,20 Series)
V*471U	ERZV□□D471	ERZV□□V471	ERZV○○D471	ERZV○○V471	(5,7,9,10,14,20 Series)
V*511U	ERZV□□D511	ERZV□□V511	ERZV○○D511	ERZV○○V511	( 7,9,10,14,20 Series)
V*621U	ERZV□□D621	ERZV□□V621	ERZV○○D621	ERZV○○V621	( 10,14,20 Series)
V*681U	ERZV□□D681	ERZV□□V681	ERZV○○D681	ERZV○○V681	( 10,14,20 Series)
V*751U	ERZV□□D751	ERZV□□V751	ERZV○○D751	ERZV○○V751	( 10,14,20 Series)
V*821U	ERZV□□D821	ERZV□□V821	ERZV○○D821	ERZV○○V821	( 10,14,20 Series)
V*911U	ERZV□□D911	ERZV□□V911	ERZV○○D911	ERZV○○V911	( 10,14,20 Series)
V*102U	ERZV□□D102	ERZV□□V102	ERZV○○D102	ERZV○○V102	( 10,14,20 Series)
V*112U	ERZV□□D112	ERZV□□V112	ERZV○○D112	ERZV○○V112	( 10,14,20 Series)
V*182U	ERZV10D182CS	ERZV14D182CS	ERZV20D182		

\* UL : Type Designation  
CSA : Part Number  
□ : Series is blank, 7series is 7, 9series is 9, 10series is 10, 14series is 14, 20series is 20  
□□ : Code for Element Size  
○○ : Code for Taping/Packing and Symbol of Element Size  
For the product Part No. except the above, contact our sales office or factory.

### ■ The AC Rated Voltage and Maximum Allowable Voltage

Standard Registration No.*	Maximum Allowable Voltage		Rated Voltage (Vrms)			
	ACrms (V)	DC (V)	UL1414	UL1449	CSA C22.2 No.1 (Class 2221 01)	VDE CECC 42 201
V*820U	50	65	(Not application)	45	(Not application)	*It is the same with the Maximum Allowable Voltage.
V*101U	60	85	(Not application)	55	(Not application)	
V*121U	75	100	(Not application)	68	(Not application)	
V*151U	95	125	(Not application)	86	(Not application)	
V*201U	130	170	125	118	118	
V*221U	140	180	125	127	127	
V*241U	150	200	125	136	136	
V*271U	175	225	125	159	159	
V*331U	210	270	125	189	189	
V*361U	230	300	125	209	209	
V*391U	250	320	250	227	227	
V*431U	275	350	250	250	250	
V*471U	300	385	250	272	272	
V*511U	315	410	250	291	291	
V*621U	385	505	250	350	350	
V*681U	420	560	250	381	381	
V*751U	460	615	250	418	418	
V*821U	510	670	250	463	463	
V*911U	550	745	250	500	500	
V*102U	625	825	250	568	568	
V*112U	680	895	250	600	618	
V*182U	1000	1465	250	600	909	

\* UL : Type Designation      \*5Series is blank, 7series is 7, 9series is 9, 10series is 10, 14series is 14, 20series is 20  
 CSA : Part Number  
 VDE : Please contact us

### ■ Application Notes

1) CSA regulate "Maximum Rating of Fuse" for using ZNR to "Audio, Video and Similer Electronic Equipment" as below

Maximum Peak Current 8/20 μs, 1 time (A)	Maximum Rating of Fuse (A)
500 and under	3
Over 500 to 2000 and under	5
Over 2000 to 6000 and under	10
Over 6000	Not Specified

2) "Rated Voltages" are specified for UL/CSA recognized components besides Maximum Allowable Voltage because of conforming to the Standby Current specified in safety standards.





















In case of making an application to UL/CSA approval for equipment with ZNR, the maximum AC operating voltage of equipment shall be lower than the ZNR Rated Voltage.



### Marking Contents and Packaging Specifications

\* Please contact us about VDE certification

#### ■ Marking Contents

Standard Part No.	ERZV05D180 to ERZV05D680	ERZV07D180 to ERZV07D680	ERZV09D180 to ERZV09D680	ERZV10D180 to ERZV10D680	ERZV14D180 to ERZV14D680	ERZV20D180 to ERZV20D680
						
Standard Part No.	ERZV05D820 to ERZV05D151	ERZV07D820 to ERZV07D151	ERZV09D820 to ERZV09D151	ERZV10D820 to ERZV10D151	ERZV14D820 to ERZV14D151	ERZV20D820 to ERZV20D151
						
Standard Part No.	ERZV05D201 to ERZV05D471	ERZV07D201 to ERZV07D511	ERZV09D201 to ERZV09D511	ERZV10D201 to ERZV10D182CS	ERZV14D201 to ERZV14D182CS	ERZV20D201 to ERZV20D182
						

#### ■ Explanation of the contents

	V * □□□□	V * □□□□U	㉿	㉿	○	◆ ◆
Trade Mark	Abbreviation of Part No.  □□□□---Nominal Varistor Voltage	Registration No.  Type Designation Part Number	UL Recognized Components Mark	CSA Monogram	Factory Identification Marking  None...Japan S ...Japan G...Singapore	Year Code and Monthly Code of the production ◆ ...<Y> 1999:9,2000:0,2001:A 2002:B,2003:C,2004:D ◇ ...<M> Jan:1 to Sep:9, Oct:O,Nov:N,Dec:D

\* : 5 series is blank, 7 series is 7, 9 series is 9, 10 series is 10, 14 series is 14, 20 series is 20

#### ■ Packaging Specifications

Standard Part No. and Taping Specification	Packing Quantity	Dimensions in mm (Packing Case)	
ERZVA5D□□□□ ERZVA7D□□□□ ERZVA9D□□□□ (Straight Leads and Taped)	1000 pcs./Box	A	55 max.
ERZVA5V□□□□ ERZVA7V□□□□ ERZVA9V□□□□ (Crimped Leads and Taped)	1000 pcs./Box	B	330 max.
ERZVGAD180 to 621 ERZVGAD681 to 112 (Straight Leads and Taped)	1000 pcs./Box 500 pcs./Box	C	340 max.
ERZVEAV180 to 621 ERZVEAV681 to 112 (Crimped Leads and Taped)	1000 pcs./Box 500 pcs./Box	A	65 max.
ERZVGED180 to 621 ERZVGED681 to 112 (Straight Leads and Taped)	500 pcs./Box 250 pcs./Box	B	360 max.
ERZVEEV180 to 621 ERZVEEV681 to 112 (Crimped Leads and Taped)	500 pcs./Box 250 pcs./Box	C	340 max.

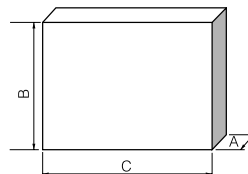

#### ■ Note

- Missing components on tape in succession shall be 3 pcs max. and total packing quantity shall be same as indications on the box.

### ■ Performance Characteristics

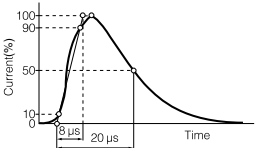
Characteristics		Test Methods/Description	Specifications																																																		
Standard Test Condition		Electrical measurements (initial/after tests) shall be conducted at temperature of 5 to 35 °C, relative humidity of maximum 85 %	_____																																																		
Varistor Voltage		The voltage between two terminals with the specified measuring current $I_{CMA}$ DC applied is called $V_C$ or $V_{CMA}$ . The measurement shall be made as fast as possible to avoid heat affection.	To meet the specified value.																																																		
Maximum Allowable Voltage		The maximum sinusoidal RMS voltage or maximum DC voltage that can be applied continuously.																																																			
Clamping Voltage		The maximum voltage between two terminals with the specified standard impulse current (8/20 $\mu$ s) illustrated below applied. 																																																			
Rated Power		The power that can be applied in the specified ambient temperature.																																																			
Maximum Energy		The maximum energy within the varistor voltage change of $\pm 10$ % when a single impulse current of 2 ms or 10/1000 $\mu$ s is applied.																																																			
Maximum Peak Current (Withstanding Surge Current)	2 times	The maximum current within the varistor voltage change of $\pm 10$ % when a standard impulse current of 8/20 $\mu$ s is applied two times with an interval of 5 minutes.																																																			
	1 time	The maximum current within the varistor voltage change of $\pm 10$ % with a single standard impulse current of 8/20 $\mu$ s is applied.																																																			
Temperature Coefficient of Varistor Voltage		$\frac{V_{CMA} \text{ at } 85^\circ\text{C} - V_{CMA} \text{ at } 25^\circ\text{C}}{V_{CMA} \text{ at } 25^\circ\text{C}} \times \frac{1}{60} \times 100 \text{ (\%/}^\circ\text{C)}$		0 to -0.05 %/°C max.																																																	
Capacitance		Capacitance shall be measured at 1 kHz $\pm 10$ %, 1 Vrms max. (1 MHz $\pm 10$ % below 100 pF), 0 V bias and $20 \pm 2^\circ\text{C}$ .		To meet the specified value																																																	
Withstanding Voltage (Body Insulation)		The specified voltage shall be applied between both terminals of the specimen connected together and metal foil closely wrapped round its body for 1 minute. <table border="1" data-bbox="396 1102 974 1189"> <thead> <tr> <th>Classification (Nominal varistor voltage)</th> <th>Test Voltage (AC)</th> </tr> </thead> <tbody> <tr> <td><math>V_{0.1\text{mA}}, V_{1\text{mA}} \leq 330\text{ V}</math></td> <td>1000 Vrms</td> </tr> <tr> <td><math>V_{0.1\text{mA}}, V_{1\text{mA}} &gt; 330\text{ V}</math></td> <td>1500 Vrms</td> </tr> </tbody> </table>		Classification (Nominal varistor voltage)	Test Voltage (AC)	$V_{0.1\text{mA}}, V_{1\text{mA}} \leq 330\text{ V}$	1000 Vrms	$V_{0.1\text{mA}}, V_{1\text{mA}} > 330\text{ V}$	1500 Vrms	No breakdown																																											
Classification (Nominal varistor voltage)	Test Voltage (AC)																																																				
$V_{0.1\text{mA}}, V_{1\text{mA}} \leq 330\text{ V}$	1000 Vrms																																																				
$V_{0.1\text{mA}}, V_{1\text{mA}} > 330\text{ V}$	1500 Vrms																																																				
Impulse Life		The change of $V_C$ shall be measured after the impulse current listed below is applied 10000 or 100000 times continuously with the interval of 10 seconds at room temperature. <table border="1" data-bbox="396 1267 974 1640"> <thead> <tr> <th rowspan="2">Part No.</th> <th colspan="2">Impulse Current</th> </tr> <tr> <th>Impulse Current</th> <th>Impulse Current</th> </tr> </thead> <tbody> <tr> <td>ERZV05D180 to ERZV05D680</td> <td>8 A (8/20 <math>\mu</math>s)</td> <td>5 A (8/20 <math>\mu</math>s)</td> </tr> <tr> <td>ERZV07D180 to ERZV07D680</td> <td>25 A (8/20 <math>\mu</math>s)</td> <td>15 A (8/20 <math>\mu</math>s)</td> </tr> <tr> <td>ERZV09D180 to ERZV09D680</td> <td>50 A (8/20 <math>\mu</math>s)</td> <td>35 A (8/20 <math>\mu</math>s)</td> </tr> <tr> <td>ERZV10D180 to ERZV10D680</td> <td>50 A (8/20 <math>\mu</math>s)</td> <td>35 A (8/20 <math>\mu</math>s)</td> </tr> <tr> <td>ERZV14D180 to ERZV14D680</td> <td>90 A (8/20 <math>\mu</math>s)</td> <td>50 A (8/20 <math>\mu</math>s)</td> </tr> <tr> <td>ERZV20D180 to ERZV20D680</td> <td>130 A (8/20 <math>\mu</math>s)</td> <td>65 A (8/20 <math>\mu</math>s)</td> </tr> <tr> <td>ERZV05D820 to ERZV05D471</td> <td>40 A (8/20 <math>\mu</math>s)</td> <td>25 A (8/20 <math>\mu</math>s)</td> </tr> <tr> <td>ERZV07D820 to ERZV07D511</td> <td>100 A (8/20 <math>\mu</math>s)</td> <td>60 A (8/20 <math>\mu</math>s)</td> </tr> <tr> <td>ERZV09D820 to ERZV09D511</td> <td>150 A (8/20 <math>\mu</math>s)</td> <td>85 A (8/20 <math>\mu</math>s)</td> </tr> <tr> <td>ERZV10D820 to ERZV10D112</td> <td>150 A (8/20 <math>\mu</math>s)</td> <td>85 A (8/20 <math>\mu</math>s)</td> </tr> <tr> <td>ERZV10D182CS</td> <td>120 A (8/20 <math>\mu</math>s)</td> <td>75 A (8/20 <math>\mu</math>s)</td> </tr> <tr> <td>ERZV14D820 to ERZV14D112</td> <td>200 A (8/20 <math>\mu</math>s)</td> <td>110 A (8/20 <math>\mu</math>s)</td> </tr> <tr> <td>ERZV14D182CS</td> <td>150 A (8/20 <math>\mu</math>s)</td> <td>90 A (8/20 <math>\mu</math>s)</td> </tr> <tr> <td>ERZV20D820 to ERZV20D112</td> <td>250 A (8/20 <math>\mu</math>s)</td> <td>120 A (8/20 <math>\mu</math>s)</td> </tr> <tr> <td>ERZV20D182</td> <td>200 A (8/20 <math>\mu</math>s)</td> <td>100 A (8/20 <math>\mu</math>s)</td> </tr> </tbody> </table>	Part No.	Impulse Current		Impulse Current	Impulse Current	ERZV05D180 to ERZV05D680	8 A (8/20 $\mu$ s)	5 A (8/20 $\mu$ s)	ERZV07D180 to ERZV07D680	25 A (8/20 $\mu$ s)	15 A (8/20 $\mu$ s)	ERZV09D180 to ERZV09D680	50 A (8/20 $\mu$ s)	35 A (8/20 $\mu$ s)	ERZV10D180 to ERZV10D680	50 A (8/20 $\mu$ s)	35 A (8/20 $\mu$ s)	ERZV14D180 to ERZV14D680	90 A (8/20 $\mu$ s)	50 A (8/20 $\mu$ s)	ERZV20D180 to ERZV20D680	130 A (8/20 $\mu$ s)	65 A (8/20 $\mu$ s)	ERZV05D820 to ERZV05D471	40 A (8/20 $\mu$ s)	25 A (8/20 $\mu$ s)	ERZV07D820 to ERZV07D511	100 A (8/20 $\mu$ s)	60 A (8/20 $\mu$ s)	ERZV09D820 to ERZV09D511	150 A (8/20 $\mu$ s)	85 A (8/20 $\mu$ s)	ERZV10D820 to ERZV10D112	150 A (8/20 $\mu$ s)	85 A (8/20 $\mu$ s)	ERZV10D182CS	120 A (8/20 $\mu$ s)	75 A (8/20 $\mu$ s)	ERZV14D820 to ERZV14D112	200 A (8/20 $\mu$ s)	110 A (8/20 $\mu$ s)	ERZV14D182CS	150 A (8/20 $\mu$ s)	90 A (8/20 $\mu$ s)	ERZV20D820 to ERZV20D112	250 A (8/20 $\mu$ s)	120 A (8/20 $\mu$ s)	ERZV20D182	200 A (8/20 $\mu$ s)	100 A (8/20 $\mu$ s)	$\Delta V_{CMA}/V_{CMA} \leq \pm 10 \%$
Part No.	Impulse Current																																																				
	Impulse Current	Impulse Current																																																			
ERZV05D180 to ERZV05D680	8 A (8/20 $\mu$ s)	5 A (8/20 $\mu$ s)																																																			
ERZV07D180 to ERZV07D680	25 A (8/20 $\mu$ s)	15 A (8/20 $\mu$ s)																																																			
ERZV09D180 to ERZV09D680	50 A (8/20 $\mu$ s)	35 A (8/20 $\mu$ s)																																																			
ERZV10D180 to ERZV10D680	50 A (8/20 $\mu$ s)	35 A (8/20 $\mu$ s)																																																			
ERZV14D180 to ERZV14D680	90 A (8/20 $\mu$ s)	50 A (8/20 $\mu$ s)																																																			
ERZV20D180 to ERZV20D680	130 A (8/20 $\mu$ s)	65 A (8/20 $\mu$ s)																																																			
ERZV05D820 to ERZV05D471	40 A (8/20 $\mu$ s)	25 A (8/20 $\mu$ s)																																																			
ERZV07D820 to ERZV07D511	100 A (8/20 $\mu$ s)	60 A (8/20 $\mu$ s)																																																			
ERZV09D820 to ERZV09D511	150 A (8/20 $\mu$ s)	85 A (8/20 $\mu$ s)																																																			
ERZV10D820 to ERZV10D112	150 A (8/20 $\mu$ s)	85 A (8/20 $\mu$ s)																																																			
ERZV10D182CS	120 A (8/20 $\mu$ s)	75 A (8/20 $\mu$ s)																																																			
ERZV14D820 to ERZV14D112	200 A (8/20 $\mu$ s)	110 A (8/20 $\mu$ s)																																																			
ERZV14D182CS	150 A (8/20 $\mu$ s)	90 A (8/20 $\mu$ s)																																																			
ERZV20D820 to ERZV20D112	250 A (8/20 $\mu$ s)	120 A (8/20 $\mu$ s)																																																			
ERZV20D182	200 A (8/20 $\mu$ s)	100 A (8/20 $\mu$ s)																																																			

### ■ Performance Characteristics

Characteristics		Test Methods	Specifications															
Mechanical	Robustness of Terminations (Tensile)	After gradually applying the force specified below and keeping the unit fixed for 10 seconds, the terminal shall be visually examined for any damage. <table border="1" style="margin-left: auto; margin-right: auto;"> <tr> <td style="text-align: center;">Terminal diameter</td> <td style="text-align: center;">Force</td> </tr> <tr> <td style="text-align: center;"><math>\phi 0.6</math> mm, <math>\phi 0.8</math> mm</td> <td style="text-align: center;">9.8 N</td> </tr> <tr> <td style="text-align: center;"><math>\phi 1.0</math> mm</td> <td style="text-align: center;">19.6 N</td> </tr> </table>	Terminal diameter	Force	$\phi 0.6$ mm, $\phi 0.8$ mm	9.8 N	$\phi 1.0$ mm	19.6 N	No remarkable mechanical damage									
	Terminal diameter	Force																
	$\phi 0.6$ mm, $\phi 0.8$ mm	9.8 N																
	$\phi 1.0$ mm	19.6 N																
	Robustness of Terminations (Bending)	The unit shall be secured with its terminal kept vertical and the force specified below shall be applied in the axial direction. The terminal shall gradually be bent by 90° in one direction, then 90° in the opposite direction, and again back to the original position. The damage of the terminal shall be visually examined. <table border="1" style="margin-left: auto; margin-right: auto;"> <tr> <td style="text-align: center;">Terminal diameter</td> <td style="text-align: center;">Force</td> </tr> <tr> <td style="text-align: center;"><math>\phi 0.6</math> mm, <math>\phi 0.8</math> mm</td> <td style="text-align: center;">4.9 N</td> </tr> <tr> <td style="text-align: center;"><math>\phi 1.0</math> mm</td> <td style="text-align: center;">9.8 N</td> </tr> </table>	Terminal diameter	Force	$\phi 0.6$ mm, $\phi 0.8$ mm	4.9 N	$\phi 1.0$ mm	9.8 N										
Terminal diameter	Force																	
$\phi 0.6$ mm, $\phi 0.8$ mm	4.9 N																	
$\phi 1.0$ mm	9.8 N																	
Vibration	After repeatedly applying a single harmonic vibration (amplitude: 0.75 mm, double amplitude: 1.5 mm) with 1 minute vibration frequency cycles (10 Hz to 55 Hz to 10 Hz) to each of three perpendicular directions for 2 hours. Thereafter, the unit shall be visually examined.																	
Solderability	After dipping the terminals to a depth of approximately 3 mm from the body in a soldering bath of 235±5 °C for 2±0.5 seconds, the terminal shall be visually examined.	Approximately 95 % of the terminals shall be covered with new solder uniformly.																
Resistance to Soldering Heat	After each lead shall be dipped into a solder bath having a temperature of 260±5 °C to a point 2.0 to 2.5 mm from the body of the unit, using shielding board (t=1.5 mm), be held there for 10±1 s (5 series: 5±1 s) and then be stored at room temperature and normal humidity for 1 to 2 hours. The change of V <sub>CmA</sub> and mechanical damages shall be examined.	$\Delta V_{CmA}/V_{CmA} \leq \pm 5 \%$ No remarkable mechanical damage																
Environmental	High Temperature Storage/Dry Heat	The specimen shall be subjected to 125±2 °C for 1000 hours in a thermostatic bath without load and then stored at room temperature and normal humidity for 1 to 2 hours. Thereafter, the change of V <sub>CmA</sub> shall be measured.	$\Delta V_{CmA}/V_{CmA} \leq \pm 5 \%$															
	Humidity (Steady State)	The specimen shall be subjected to 40±2 °C, 90 to 95 % RH for 1000 hours without load and then stored at room temperature and normal humidity for 1 to 2 hours. Thereafter, the change of V <sub>CmA</sub> shall be measured.	$\Delta V_{CmA}/V_{CmA} \leq \pm 5 \%$															
	Temperature Cycle	The temperature cycle shown below shall be repeated five cycles and then stored at room temperature and normal humidity for 1 to 2 hours. The change of V <sub>CmA</sub> and mechanical damage shall be examined. <table border="1" style="margin-left: auto; margin-right: auto;"> <thead> <tr> <th>Step</th> <th>Temperature (°C)</th> <th>Period (minutes)</th> </tr> </thead> <tbody> <tr> <td style="text-align: center;">1</td> <td style="text-align: center;">-40±3</td> <td style="text-align: center;">30±3</td> </tr> <tr> <td style="text-align: center;">2</td> <td style="text-align: center;">Room temperature</td> <td style="text-align: center;">15±3</td> </tr> <tr> <td style="text-align: center;">3</td> <td style="text-align: center;">125±2</td> <td style="text-align: center;">30±3</td> </tr> <tr> <td style="text-align: center;">4</td> <td style="text-align: center;">Room temperature</td> <td style="text-align: center;">15±3</td> </tr> </tbody> </table>	Step	Temperature (°C)	Period (minutes)	1	-40±3	30±3	2	Room temperature	15±3	3	125±2	30±3	4	Room temperature	15±3	$\Delta V_{CmA}/V_{CmA} \leq \pm 5 \%$ No remarkable mechanical damage
	Step	Temperature (°C)	Period (minutes)															
	1	-40±3	30±3															
	2	Room temperature	15±3															
3	125±2	30±3																
4	Room temperature	15±3																
High Temperature Load/Dry Heat Load	After being continuously applied the Maximum Allowable Voltage at 85±2 °C for 1000 hours, the specimen shall be stored at room temperature and normal humidity for 1 to 2 hours. Thereafter, the change of V <sub>CmA</sub> shall be measured.	$\Delta V_{CmA}/V_{CmA} \leq \pm 10 \%$																
Damp Heat Load/Humidity Load	The specimen shall be subjected to 40±2 °C, 90 to 95 % RH and the Maximum Allowable Voltage for 1000 hours and then stored at room temperature and normal humidity for 1 to 2 hours. Thereafter, the change of V <sub>CmA</sub> shall be measured.	$\Delta V_{CmA}/V_{CmA} \leq \pm 10 \%$																
Low Temperature Storage/Cold	The specimen shall be subjected to -40±2 °C without load for 1000 hours and then stored at room temperature and normal humidity for 1 to 2 hours. Thereafter, the change of V <sub>CmA</sub> shall be measured.	$\Delta V_{CmA}/V_{CmA} < \pm 5 \%$																

# Mouser Electronics

Authorized Distributor

Click to View Pricing, Inventory, Delivery & Lifecycle Information:

## Panasonic:

[ERZ-V07D330](#) [ERZ-V07D180](#) [ERZ-V05D471CS](#) [ERZ-V10D270](#) [ERZ-V14D101](#) [ERZ-V07D101](#) [ERZ-V14D330](#)  
[ERZ-V20R271](#) [ERZ-V20R431](#) [ERZ-V09D241](#) [ERZ-V05D121](#) [ERZ-V05D180](#) [ERZ-V05D201](#) [ERZ-V05D220](#) [ERZ-](#)  
[V05D241](#) [ERZ-V05D330](#) [ERZ-V05D431](#) [ERZ-V05D470](#) [ERZ-V05D471](#) [ERZ-V05D680](#) [ERZ-V07D151](#) [ERZ-](#)  
[V07D220](#) [ERZ-V07D221](#) [ERZ-V07D241](#) [ERZ-V07D270](#) [ERZ-V07D271](#) [ERZ-V07D390](#) [ERZ-V07D391](#) [ERZ-](#)  
[V07D431](#) [ERZ-V07D470](#) [ERZ-V07D471](#) [ERZ-V07D560](#) [ERZ-V07D680](#) [ERZ-V07D820](#) [ERZ-V10D101](#) [ERZ-](#)  
[V10D182](#) [ERZ-V10D201](#) [ERZ-V10D221](#) [ERZ-V10D271](#) [ERZ-V10D330](#) [ERZ-V10D390](#) [ERZ-V10D431](#) [ERZ-](#)  
[V10D470](#) [ERZ-V10D471](#) [ERZ-V10D511](#) [ERZ-V10D560](#) [ERZ-V10D621](#) [ERZ-V14D112](#) [ERZ-V14D182](#) [ERZ-](#)  
[V14D201](#) [ERZ-V14D220](#) [ERZ-V14D221](#) [ERZ-V14D241](#) [ERZ-V14D270](#) [ERZ-V14D271](#) [ERZ-V14D390](#) [ERZ-](#)  
[V14D391](#) [ERZ-V14D431](#) [ERZ-V14D470](#) [ERZ-V14D471](#) [ERZ-V05D560](#) [ERZ-V10D220](#) [ERZ-V14V431CS](#) [ERZ-](#)  
[V10D681](#) [ERZ-V14D821](#) [ERZ-V14V751CS](#) [ERZ-V05D101](#) [ERZ-V05D101CS](#) [ERZ-V05D121CS](#) [ERZ-V05D151](#)  
[ERZ-V05D151CS](#) [ERZ-V05D180CS](#) [ERZ-V05D201CS](#) [ERZ-V05D220CS](#) [ERZ-V05D221](#) [ERZ-V05D221CS](#) [ERZ-](#)  
[V05D241CS](#) [ERZ-V05D270](#) [ERZ-V05D270CS](#) [ERZ-V05D271](#) [ERZ-V05D271CS](#) [ERZ-V05D330CS](#) [ERZ-V05D331](#)  
[ERZ-V05D331CS](#) [ERZ-V05D361](#) [ERZ-V05D361CS](#) [ERZ-V05D390](#) [ERZ-V05D390CS](#) [ERZ-V05D391](#) [ERZ-](#)  
[V05D391CS](#) [ERZ-V05D431CS](#) [ERZ-V05D470CS](#) [ERZ-V05D560CS](#) [ERZ-V05D680CS](#) [ERZ-V05D820](#) [ERZ-](#)  
[V05D820CS](#) [ERZ-V05V101CS](#) [ERZ-V05V121CS](#) [ERZ-V05V151CS](#) [ERZ-V05V180CS](#)