



FEATURES

- **Compact flat type**
We successfully developed a high carrying current type that is the same size as our CP relay (14 mm (L) x 13 mm (W) x 9.5 mm (H) .551 inch (L) x .512 inch (W) x .374 inch (H)).
- **35A maximum carrying current**
Current carrying of 35 A/1h and 45 A/2 min. at 20°C (450 W type, 16 V applied) is possible due to use of N.O. double pin terminals and COM terminal width expansion.
- **Supports capacitor loads required for power supply applications**
Inrush current: 60A, steady-state current: 1A and 10⁵ switching times possible.
- **Plastic sealed type**
This plastic sealed type can be automatically cleaned.

TYPICAL APPLICATIONS

For automotive system
Defoggers, Ignitions, Heaters, Accessories, Power windows, etc.

ORDERING INFORMATION

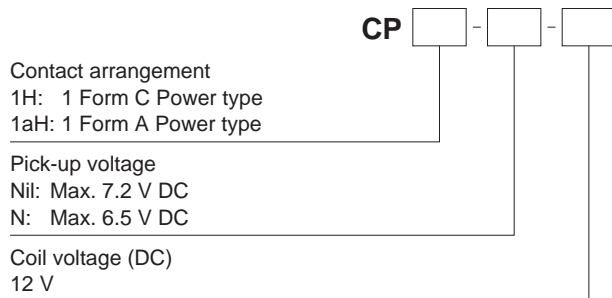

TYPES

Contact arrangement	Coil voltage	Pick-up voltage (at 20°C 68°F)	Part No.
1 Form C	12 V DC	Max. 7.2 V DC (Initial)	CP1H-12V
		Max. 6.5 V DC (Initial)	CP1H-N-12V
1 Form A		Max. 7.2 V DC (Initial)	CP1aH-12V
		Max. 6.5 V DC (Initial)	CP1aH-N-12V

Standard packing: Carton (Tube): 40 pcs.; Case: 1,000 pcs.
Note: THD type only

CP POWER

RATING

1. Coil data

Nominal coil voltage	Pick-up voltage (at 20°C 68°F)	Drop-out voltage (at 20°C 68°F)	Nominal operating current [$\pm 10\%$] (at 20°C 68°F)	Coil resistance [$\pm 10\%$] (at 20°C 68°F)	Nominal operating power (at 20°C 68°F)	Usable voltage range (at 85°C 185°F)
12V DC	Max. 7.2 V DC (Initial)	Min. 1.0 V DC (Initial)	37.5 mA	320 Ω	450 mW	10 to 16V DC
	Max. 6.5 V DC (Initial)		53.3 mA	225 Ω	640 mW	10 to 16V DC

2. Specifications

Characteristics	Item	Specifications	
Contact	Arrangement	1 Form A, 1 Form C	
	Contact resistance (Initial)	N.O.: Typ 6m Ω , N.C.: Typ 8m Ω (By voltage drop 6V DC 1A)	
	Contact material	Ag alloy (Cadmium free)	
Rating	Nominal switching capacity (resistive load)	N.O.: 20 A 14V DC, N.C.: 10 A 14V DC	
	Max. carrying current (16V DC)*3	N.O.: <For 450 mW> 45 A for 2 minutes, 35 A for 1 hour at 20°C 68°F 40 A for 2 minutes, 30 A for 1 hour at 85°C 185°F <For 640 mW> 40 A for 2 minutes, 30 A for 1 hour at 20°C 68°F 35 A for 2 minutes, 25 A for 1 hour at 85°C 185°F	
	Nominal operating power	450 mW for pick-up voltage 7.2 V DC, 640 mW for pick-up voltage 6.5 V DC	
	Min. switching capacity (resistive load)*1	1 A 14V DC	
	Insulation resistance (Initial)	Min. 100 M Ω (at 500V DC, Measurement at same location as "Breakdown voltage" section.)	
Electrical characteristics	Breakdown voltage (Initial)	Between open contacts	500 Vrms for 1 min. (Detection current: 10mA)
		Between contacts and coil	500 Vrms for 1 min. (Detection current: 10mA)
	Operate time (at nominal voltage)	Max. 10ms (at 20°C 68°F, excluding contact bounce time) (Initial)	
	Release time (at nominal voltage)	Max. 10ms (at 20°C 68°F, excluding contact bounce time) (Initial)	
Mechanical characteristics	Shock resistance	Functional	Min. 100 m/s ² {10G} (Half-wave pulse of sine wave: 11ms; detection time: 10 μ s)
		Destructive	Min. 1,000 m/s ² {100G} (Half-wave pulse of sine wave: 6ms)
	Vibration resistance	Functional	10 Hz to 100 Hz, Min. 44.1 m/s ² {4.5G} (Detection time: 10 μ s)
		Destructive	10 Hz to 500 Hz, Min. 44.1 m/s ² {4.5G}, Time of vibration for each direction; X, Y direction: 2 hours, Z direction: 4 hours
Expected life	Mechanical	Min. 10 ⁷ (at 120 cpm)	
	Electrical	<Resistive load> Min. 10 ⁵ (at nominal switching capacity, operating frequency: 1s ON, 9s OFF) <Capacitor load> Min. 10 ⁵ (at Inrush 60A, Steady 1A 14 V DC, operating frequency: 1s ON, 9s OFF)	
Conditions	Conditions for operation, transport and storage*2	Ambient temperature: -40°C to +85°C -40°F to +185°F, Humidity: 5% R.H. to 85% R.H. (Not freezing and condensing at low temperature)	
	Max. operating speed	6 cpm (at nominal switching capacity)	
Mass		Approx. 4.5 g .16 oz	

Notes:

*1. This value can change due to the switching frequency, environmental conditions, and desired reliability level, therefore it is recommended to check this with the actual load.

*2. The upper operation ambient temperature limit is the maximum temperature that can satisfy the coil temperature rise value. Refer to "6. Usage, Storage and Transport Conditions" in [AMBIENT ENVIRONMENT section in Relay Technical Information](#).

Please inquire if you will be using the relay in a high temperature atmosphere (110°C 230°F).

*3. Depends on connection conditions. Also, this does not guarantee repeated switching. We recommend that you confirm operation under actual conditions.

REFERENCE DATA

1-(1). Coil temperature rise

Sample : CP1H-12V, 3pcs
 Point measured : Inside the coil
 Ambient temperature: 27°C 81°F

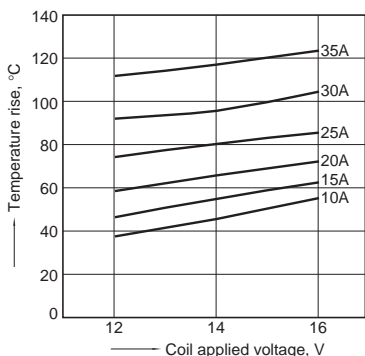

1-(2). Coil temperature rise

Sample : CP1H-12V, 3pcs
 Point measured : Inside the coil
 Ambient temperature: 85°C 185°F

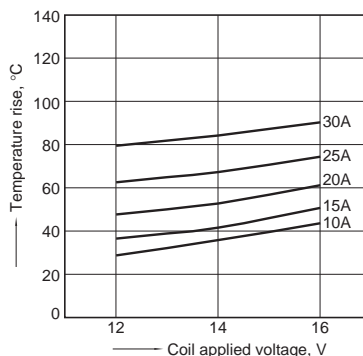

2. Ambient temperature and operating voltage range

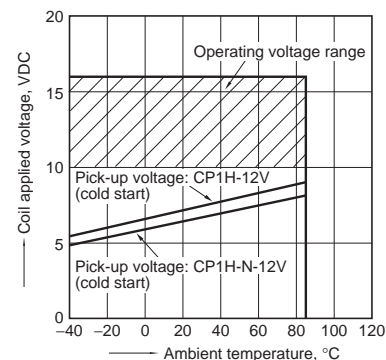

3-(1). Distribution of pick-up and drop-out voltage

Sample : CP1H-12V, 20pcs.

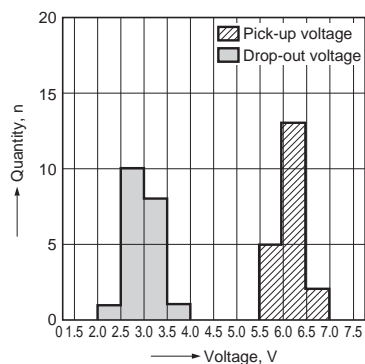

3-(2). Distribution of pick-up and drop-out voltage

Sample : CP1H-N-12V, 20pcs.

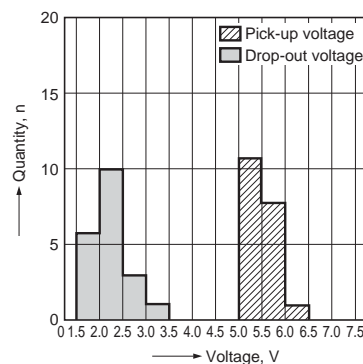

4-(1). Distribution of operate and release time

Sample : CP1H-12V, 20pcs.

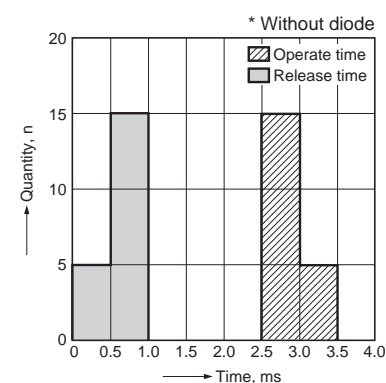

4-(2). Distribution of operate and release time

Sample : CP1H-N-12V, 20pcs.

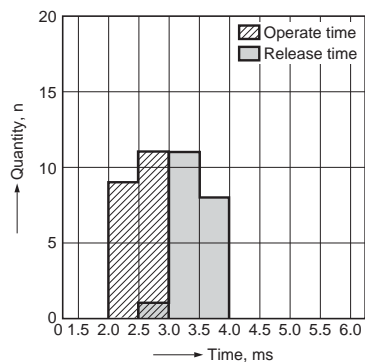

5-(1). Electrical life test (at rated load)

Sample : CP1H-12V
 Quantity : n = 6
 Load : Resistive load (N.O. side : 20 A 14 V DC)
 Operating frequency : ON 1s, OFF 9s
 Ambient temperature : Room temperature

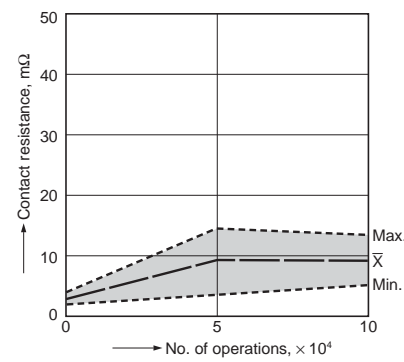
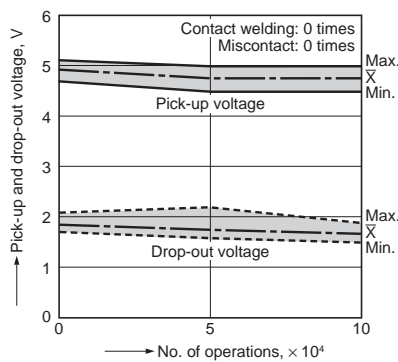

5-(2). Electrical life test (at capacitor load)

Sample : CP1H-12V, 6pcs.
 Load : Inrush 60A/steady 1A
 Operating frequency : ON 1s, OFF 9s
 Ambient temperature : Room temperature

Circuit :

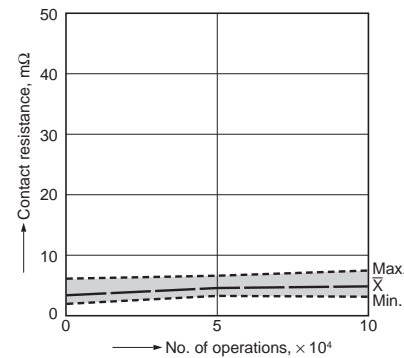
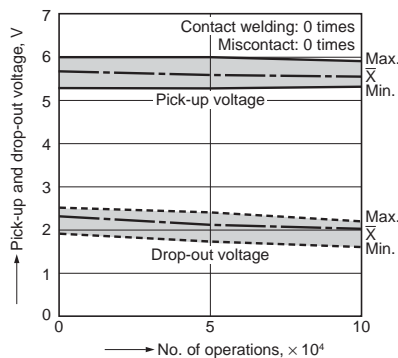
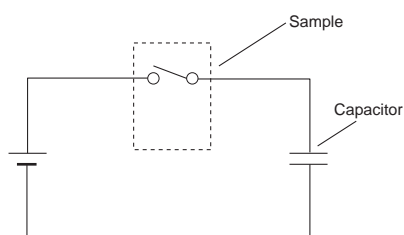

CAD Data

External dimensions

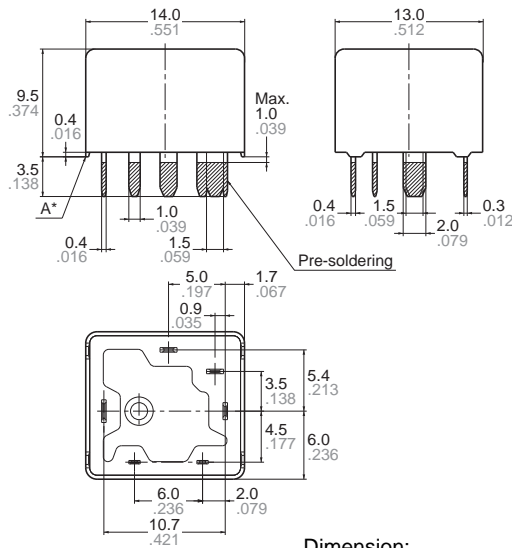

<u>Dimension:</u>	<u>Tolerance</u>
Max. 1mm .039 inch:	$\pm 0.1 \pm .004$
1 to 3mm .039 to .118 inch:	$\pm 0.2 \pm .008$
Min. 3mm .118 inch:	$\pm 0.3 \pm .012$

PC board pattern (Bottom view)

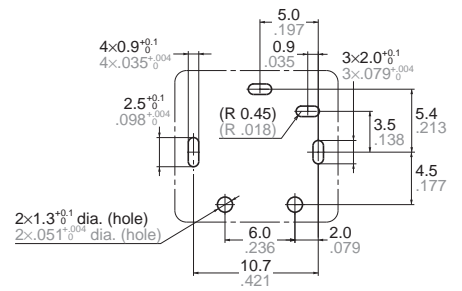

Tolerance: $\pm 0.1 \pm .004$

Schematic (Bottom view)

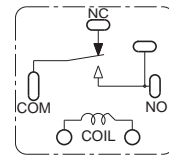

* Dimensions (thickness and width) of terminal is measured before pre-soldering.
Intervals between terminals is measured at A surface level.

For Cautions for Use, see [Relay Technical Information](#).