

## FEATURES

- **Low Noise:**  $20\mu\text{V}_{\text{RMS}}$  (10Hz to 100kHz)
- **Output Current:** 500mA
- **Low Quiescent Current:**  $30\mu\text{A}$
- **Wide Input Voltage Range:** 1.8V to 20V
- **Low Dropout Voltage:** 300mV
- **Very Low Shutdown Current:**  $< 1\mu\text{A}$
- No Protection Diodes Needed
- Fixed Output Voltages: 1.5V, 1.8V, 2.5V, 3V, 3.3V, 5V
- Adjustable Output from 1.22V to 20V
- Stable with  $3.3\mu\text{F}$  Output Capacitor
- Stable with Aluminum, Tantalum or Ceramic Capacitors
- Reverse Battery Protection
- No Reverse Current
- Overcurrent and Overtemperature Protected
- 8-Lead SO Package

## APPLICATIONS

- Cellular Phones
- Battery-Powered Systems
- Noise-Sensitive Instrumentation Systems

## DESCRIPTION

The LT<sup>®</sup>1763 series are micropower, low noise, low dropout regulators. The devices are capable of supplying 500mA of output current with a dropout voltage of 300mV. Designed for use in battery-powered systems, the low  $30\mu\text{A}$  quiescent current makes them an ideal choice. Quiescent current is well controlled; it does not rise in dropout as it does with many other regulators.

A key feature of the LT1763 regulators is low output noise. With the addition of an external  $0.01\mu\text{F}$  bypass capacitor, output noise drops to  $20\mu\text{V}_{\text{RMS}}$  over a 10Hz to 100kHz bandwidth. The LT1763 regulators are stable with output capacitors as low as  $3.3\mu\text{F}$ . Small ceramic capacitors can be used without the series resistance required by other regulators.

Internal protection circuitry includes reverse battery protection, current limiting, thermal limiting and reverse current protection. The parts come in fixed output voltages of 1.5V, 1.8V, 2.5V, 3V, 3.3V and 5V, and as an adjustable device with a 1.22V reference voltage. The LT1763 regulators are available in the 8-lead SO package.

 LTC and LT are registered trademarks of Linear Technology Corporation.

## TYPICAL APPLICATION

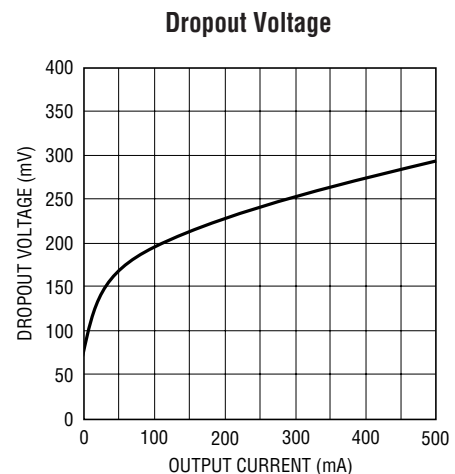
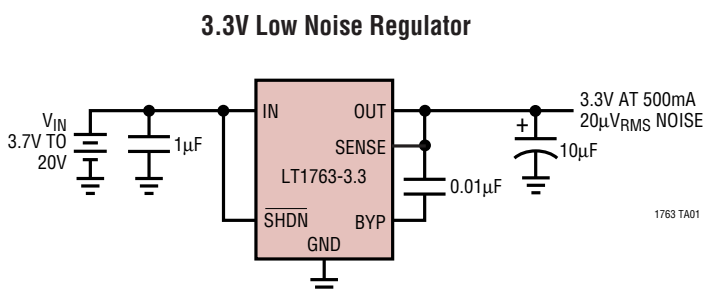

1763 TA02

# LT1763 Series

## ABSOLUTE MAXIMUM RATINGS

(Note 1)

|  |                |
|--|----------------|
| IN Pin Voltage .....                                   | ±20V           |
| OUT Pin Voltage .....                                  | ±20V           |
| Input to Output Differential Voltage .....             | ±20V           |
| SENSE Pin Voltage .....                                | ±20V           |
| ADJ Pin Voltage .....                                  | ±7V            |
| BYP Pin Voltage .....                                  | ±0.6V          |
| SHDN Pin Voltage .....                                 | ±20V           |
| Output Short-Circuit Duration .....                    | Indefinite     |
| Operating Junction Temperature Range<br>(Note 2) ..... | -40°C to 125°C |
| Storage Temperature Range .....                        | -65°C to 150°C |
| Lead Temperature (Soldering, 10 sec) .....             | 300°C          |

## PACKAGE/ORDER INFORMATION

TOP VIEW

S8 PACKAGE  
8-LEAD PLASTIC SO

\*PIN 2: SENSE FOR LT1763-1.5/  
LT1763-1.8/LT1763-2.5/  
LT1763-3/LT1763-3.3/LT1763-5  
ADJ FOR LT1763

$T_{JMAX} = 150^{\circ}C$ ,  $\theta_{JA} = 70^{\circ}C/W$ ,  
 $\theta_{JC} = 35^{\circ}C/W$

SEE THE APPLICATIONS  
INFORMATION SECTION.

| ORDER PART NUMBER |               | S8 PART MARKING |        |
|-------------------|---------------|-----------------|--------|
| LT1763CS8         | LT1763CS8-3   | 1763            | 17633  |
| LT1763CS8-1.5     | LT1763CS8-3.3 | 176315          | 176333 |
| LT1763CS8-1.8     | LT1763CS8-5   | 176318          | 17635  |
| LT1763CS8-2.5     |               | 176325          |        |

Consult LTC Marketing for parts specified with wider operating temperature ranges.

## ELECTRICAL CHARACTERISTICS

The ● denotes specifications which apply over the full operating temperature range, otherwise specifications are  $T_A = 25^{\circ}C$ . (Note 2)

| PARAMETER   | CONDITIONS  | MIN   | TYP   | MAX   | UNITS |    |
|---|---|-------|-------|-------|-------|----|
| Minimum Operating Voltage   | $I_{LOAD} = 500mA$ (Notes 3, 11)  | ●     | 1.8   | 2.3   | V     |    |
| Regulated Output Voltage<br>(Note 4)  | LT1763-1.5 $V_{IN} = 2V$ , $I_{LOAD} = 1mA$<br>$2.5V < V_{IN} < 20V$ , $1mA < I_{LOAD} < 500mA$                         | ●     | 1.485 | 1.5   | 1.515 | V  |
|   |   | ●     | 1.462 | 1.5   | 1.538 | V  |
|   | LT1763-1.8 $V_{IN} = 2.3V$ , $I_{LOAD} = 1mA$<br>$2.8V < V_{IN} < 20V$ , $1mA < I_{LOAD} < 500mA$                       | ●     | 1.782 | 1.8   | 1.818 | V  |
|   |   | ●     | 1.755 | 1.8   | 1.845 | V  |
|   | LT1763-2.5 $V_{IN} = 3V$ , $I_{LOAD} = 1mA$<br>$3.5V < V_{IN} < 20V$ , $1mA < I_{LOAD} < 500mA$                         | ●     | 2.475 | 2.5   | 2.525 | V  |
|   |   | ●     | 2.435 | 2.5   | 2.565 | V  |
|   | LT1763-3 $V_{IN} = 3.5V$ , $I_{LOAD} = 1mA$<br>$4V < V_{IN} < 20V$ , $1mA < I_{LOAD} < 500mA$                           | ●     | 2.970 | 3     | 3.030 | V  |
|   | ●   | 2.925 | 3     | 3.075 | V     |    |
| LT1763-3.3 $V_{IN} = 3.8V$ , $I_{LOAD} = 1mA$<br>$4.3V < V_{IN} < 20V$ , $1mA < I_{LOAD} < 500mA$ | ●   | 3.267 | 3.3   | 3.333 | V     |    |
|   | ●   | 3.220 | 3.3   | 3.380 | V     |    |
| LT1763-5 $V_{IN} = 5.5V$ , $I_{LOAD} = 1mA$<br>$6V < V_{IN} < 20V$ , $1mA < I_{LOAD} < 500mA$     | ●   | 4.950 | 5     | 5.050 | V     |    |
|   | ●   | 4.875 | 5     | 5.125 | V     |    |
| ADJ Pin Voltage<br>(Notes 3, 4)   | LT1763 $V_{IN} = 2V$ , $I_{LOAD} = 1mA$<br>$2.22V < V_{IN} < 20V$ , $1mA < I_{LOAD} < 500mA$                            | ●     | 1.208 | 1.22  | 1.232 | V  |
|   |   | ●     | 1.190 | 1.22  | 1.250 | V  |
| Line Regulation   | LT1763-1.5 $\Delta V_{IN} = 2V$ to $20V$ , $I_{LOAD} = 1mA$   | ●     |       | 1     | 5     | mV |
|   | LT1763-1.8 $\Delta V_{IN} = 2.3V$ to $20V$ , $I_{LOAD} = 1mA$   | ●     |       | 1     | 5     | mV |
|   | LT1763-2.5 $\Delta V_{IN} = 3V$ to $20V$ , $I_{LOAD} = 1mA$   | ●     |       | 1     | 5     | mV |
|   | LT1763-3 $\Delta V_{IN} = 3.5V$ to $20V$ , $I_{LOAD} = 1mA$   | ●     |       | 1     | 5     | mV |
|   | LT1763-3.3 $\Delta V_{IN} = 3.8V$ to $20V$ , $I_{LOAD} = 1mA$   | ●     |       | 1     | 5     | mV |
|   | LT1763-5 $\Delta V_{IN} = 5.5V$ to $20V$ , $I_{LOAD} = 1mA$   | ●     |       | 1     | 5     | mV |
|   | LT1763 (Note 3) $\Delta V_{IN} = 2V$ to $20V$ , $I_{LOAD} = 1mA$  | ●     |       | 1     | 5     | mV |
| Load Regulation   | LT1763-1.5 $V_{IN} = 2.5V$ , $\Delta I_{LOAD} = 1mA$ to $500mA$<br>$V_{IN} = 2.5V$ , $\Delta I_{LOAD} = 1mA$ to $500mA$ | ●     |       | 3     | 8     | mV |
|   |   | ●     |       |       | 15    | mV |
|   | LT1763-1.8 $V_{IN} = 2.8V$ , $\Delta I_{LOAD} = 1mA$ to $500mA$<br>$V_{IN} = 2.8V$ , $\Delta I_{LOAD} = 1mA$ to $500mA$ | ●     |       | 4     | 9     | mV |
|   |   | ●     |       |       | 18    | mV |
|   | LT1763-2.5 $V_{IN} = 3.5V$ , $\Delta I_{LOAD} = 1mA$ to $500mA$<br>$V_{IN} = 3.5V$ , $\Delta I_{LOAD} = 1mA$ to $500mA$ | ●     |       | 5     | 12    | mV |
|   |   | ●     |       |       | 25    | mV |

1763fa

## ELECTRICAL CHARACTERISTICS

The ● denotes specifications which apply over the full operating temperature range, otherwise specifications are  $T_A = 25^\circ\text{C}$ . (Note 2)

| PARAMETER  | CONDITIONS  | MIN | TYP  | MAX                  | UNITS               |
|--|---|-----|------|----------------------|---------------------|
| Load Regulation  | LT1763-3<br>$V_{IN} = 4\text{V}$ , $\Delta I_{LOAD} = 1\text{mA}$ to 500mA<br>$V_{IN} = 4\text{V}$ , $\Delta I_{LOAD} = 1\text{mA}$ to 500mA            | ●   | 7    | 15<br>30             | mV<br>mV            |
|  | LT1763-3.3<br>$V_{IN} = 4.3\text{V}$ , $\Delta I_{LOAD} = 1\text{mA}$ to 500mA<br>$V_{IN} = 4.3\text{V}$ , $\Delta I_{LOAD} = 1\text{mA}$ to 500mA      | ●   | 7    | 17<br>33             | mV<br>mV            |
|  | LT1763-5<br>$V_{IN} = 6\text{V}$ , $\Delta I_{LOAD} = 1\text{mA}$ to 500mA<br>$V_{IN} = 6\text{V}$ , $\Delta I_{LOAD} = 1\text{mA}$ to 500mA            | ●   |      | 12<br>25<br>50       | mV<br>mV            |
|  | LT1763 (Note 3)<br>$V_{IN} = 2.3\text{V}$ , $\Delta I_{LOAD} = 1\text{mA}$ to 500mA<br>$V_{IN} = 2.3\text{V}$ , $\Delta I_{LOAD} = 1\text{mA}$ to 500mA | ●   |      | 2<br>6<br>12         | mV<br>mV            |
| Dropout Voltage<br>$V_{IN} = V_{OUT(NOMINAL)}$<br>(Notes 5, 6, 11) | $I_{LOAD} = 10\text{mA}$<br>$I_{LOAD} = 10\text{mA}$  | ●   |      | 0.13<br>0.19<br>0.25 | V<br>V              |
|  | $I_{LOAD} = 50\text{mA}$<br>$I_{LOAD} = 50\text{mA}$  | ●   |      | 0.17<br>0.22<br>0.32 | V<br>V              |
|  | $I_{LOAD} = 100\text{mA}$<br>$I_{LOAD} = 100\text{mA}$  | ●   |      | 0.20<br>0.24<br>0.34 | V<br>V              |
|  | $I_{LOAD} = 500\text{mA}$<br>$I_{LOAD} = 500\text{mA}$  | ●   |      | 0.30<br>0.35<br>0.45 | V<br>V              |
| GND Pin Current<br>$V_{IN} = V_{OUT(NOMINAL)}$<br>(Notes 5, 7)     | $I_{LOAD} = 0\text{mA}$   | ●   |      | 30<br>75             | $\mu\text{A}$       |
|  | $I_{LOAD} = 1\text{mA}$   | ●   |      | 65<br>120            | $\mu\text{A}$       |
|  | $I_{LOAD} = 50\text{mA}$  | ●   |      | 1.1<br>1.6           | mA                  |
|  | $I_{LOAD} = 100\text{mA}$   | ●   |      | 2<br>3               | mA                  |
|  | $I_{LOAD} = 250\text{mA}$   | ●   |      | 5<br>8               | mA                  |
|  | $I_{LOAD} = 500\text{mA}$   | ●   |      | 11<br>16             | mA                  |
| Output Voltage Noise   | $C_{OUT} = 10\mu\text{F}$ , $C_{BYP} = 0.01\mu\text{F}$ , $I_{LOAD} = 500\text{mA}$ , BW = 10Hz to 100kHz   |     |      | 20                   | $\mu\text{V}_{RMS}$ |
| ADJ Pin Bias Current   | (Notes 3, 8)  |     |      | 30<br>100            | nA                  |
| Shutdown Threshold   | $V_{OUT} = \text{Off to On}$  | ●   |      | 0.8<br>2             | V                   |
|  | $V_{OUT} = \text{On to Off}$  | ●   | 0.25 | 0.65                 | V                   |
| SHDN Pin Current<br>(Note 9)                                       | $V_{SHDN} = 0\text{V}$  |     |      | 0.1<br>1             | $\mu\text{A}$       |
|  | $V_{SHDN} = 20\text{V}$   |     |      |                      | $\mu\text{A}$       |
| Quiescent Current in Shutdown                                      | $V_{IN} = 6\text{V}$ , $V_{SHDN} = 0\text{V}$   |     |      | 0.1<br>1             | $\mu\text{A}$       |
| Ripple Rejection   | $V_{IN} - V_{OUT} = 1.5\text{V}$ (Avg), $V_{RIPPLE} = 0.5\text{V}_{P-P}$ , $f_{RIPPLE} = 120\text{Hz}$ ,<br>$I_{LOAD} = 500\text{mA}$                   |     |      | 50<br>65             | dB                  |
| Current Limit  | $V_{IN} = 7\text{V}$ , $V_{OUT} = 0\text{V}$  |     |      | 700                  | mA                  |
|  | $V_{IN} = V_{OUT(NOMINAL)} + 1\text{V}$ , $\Delta V_{OUT} = -0.1\text{V}$   | ●   | 520  |                      | mA                  |
| Input Reverse Leakage Current                                      | $V_{IN} = -20\text{V}$ , $V_{OUT} = 0\text{V}$  | ●   |      | 1                    | mA                  |
| Reverse Output Current<br>(Note 10)                                | LT1763-1.5<br>$V_{OUT} = 1.5\text{V}$ , $V_{IN} < 1.5\text{V}$  |     |      | 10<br>20             | $\mu\text{A}$       |
|  | LT1763-1.8<br>$V_{OUT} = 1.8\text{V}$ , $V_{IN} < 1.8\text{V}$  |     |      | 10<br>20             | $\mu\text{A}$       |
|  | LT1763-2.5<br>$V_{OUT} = 2.5\text{V}$ , $V_{IN} < 2.5\text{V}$  |     |      | 10<br>20             | $\mu\text{A}$       |
|  | LT1763-3<br>$V_{OUT} = 3\text{V}$ , $V_{IN} < 3\text{V}$  |     |      | 10<br>20             | $\mu\text{A}$       |
|  | LT1763-3.3<br>$V_{OUT} = 3.3\text{V}$ , $V_{IN} < 3.3\text{V}$  |     |      | 10<br>20             | $\mu\text{A}$       |
|  | LT1763-5<br>$V_{OUT} = 5\text{V}$ , $V_{IN} < 5\text{V}$  |     |      | 10<br>20             | $\mu\text{A}$       |
|  | LT1763 (Note 3)<br>$V_{OUT} = 1.22\text{V}$ , $V_{IN} < 1.22\text{V}$   |     |      | 5<br>10              | $\mu\text{A}$       |

**Note 1:** Absolute Maximum Ratings are those values beyond which the life of a device may be impaired.

**Note 2:** The LT1763 regulators are tested and specified under pulse load conditions such that  $T_J \approx T_A$ . The LT1763 is 100% tested at  $T_A = 25^\circ\text{C}$ . Performance at  $-40^\circ\text{C}$  and  $125^\circ\text{C}$  is assured by design, characterization and correlation with statistical process controls.

**Note 3:** The LT1763 (adjustable version) is tested and specified for these conditions with the ADJ pin connected to the OUT pin.

**Note 4:** Operating conditions are limited by maximum junction temperature. The regulated output voltage specification will not apply for

all possible combinations of input voltage and output current. When operating at maximum input voltage, the output current range must be limited. When operating at maximum output current, the input voltage range must be limited.

**Note 5:** To satisfy requirements for minimum input voltage, the LT1763 (adjustable version) is tested and specified for these conditions with an external resistor divider (two 250k resistors) for an output voltage of 2.44V. The external resistor divider will add a  $5\mu\text{A}$  DC load on the output.

## ELECTRICAL CHARACTERISTICS

**Note 6:** Dropout voltage is the minimum input to output voltage differential needed to maintain regulation at a specified output current. In dropout, the output voltage will be equal to:  $V_{IN} - V_{DROPOUT}$ .

**Note 7:** GND pin current is tested with  $V_{IN} = V_{OUT(NOMINAL)}$  or  $V_{IN} = 2.3V$  (whichever is greater) and a current source load. This means the device is tested while operating in its dropout region. This is the worst-case GND pin current. The GND pin current will decrease slightly at higher input voltages.

**Note 8:** ADJ pin bias current flows into the ADJ pin.

**Note 9:**  $\overline{SHDN}$  pin current flows into the  $\overline{SHDN}$  pin.

**Note 10:** Reverse output current is tested with the IN pin grounded and the OUT pin forced to the rated output voltage. This current flows into the OUT pin and out the GND pin.

**Note 11:** For the LT1763, LT1763-1.5 and LT1763-1.8 dropout voltage will be limited by the minimum input voltage specification under some output voltage/load conditions. See the curve of Minimum Input Voltage in the Typical Performance Characteristics.

## TYPICAL PERFORMANCE CHARACTERISTICS

Typical Dropout Voltage

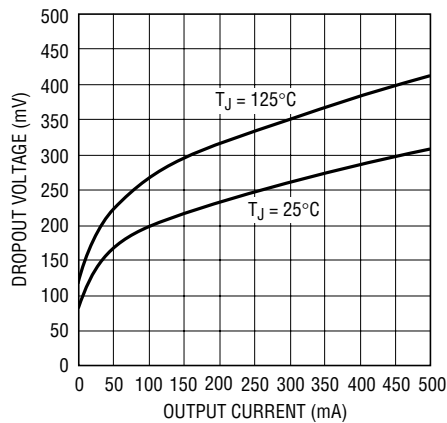

1763 G01

Guaranteed Dropout Voltage

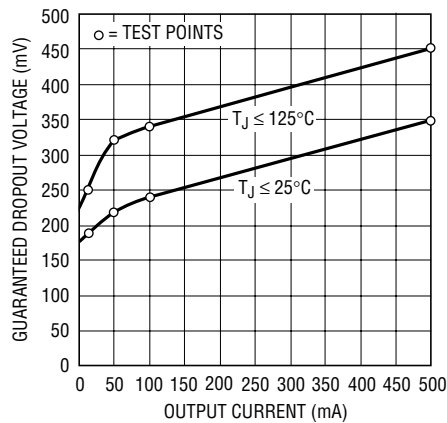

1763 G02

Dropout Voltage

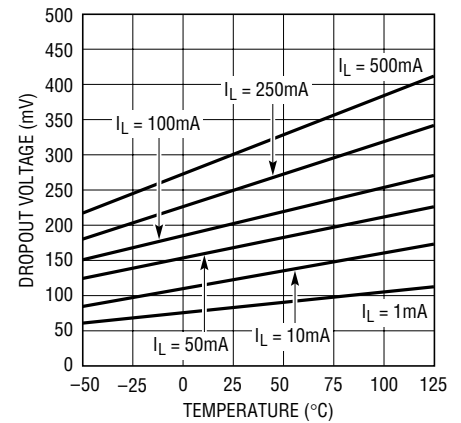

1763 G03

Quiescent Current

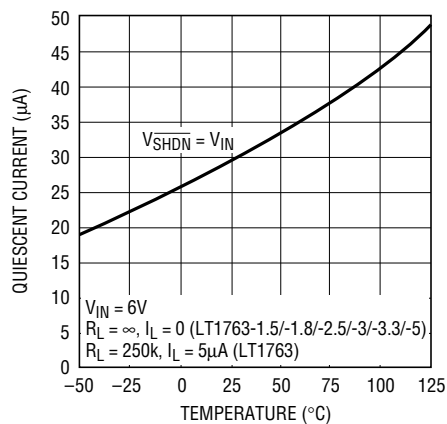

1763 G04

LT1763-1.5 Output Voltage

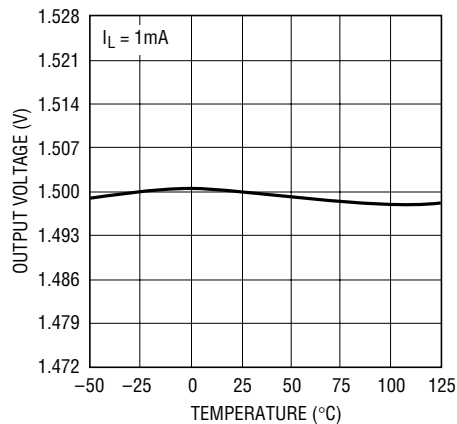

1763 G50

LT1763-1.8 Output Voltage

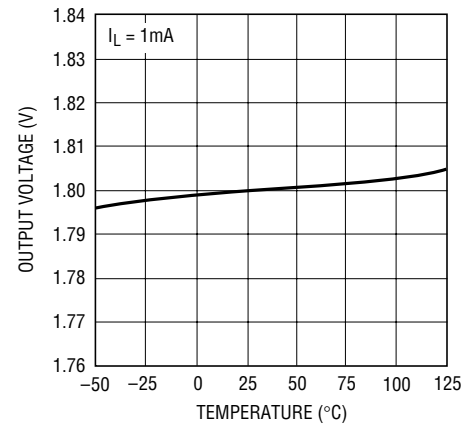

1763 G51

# TYPICAL PERFORMANCE CHARACTERISTICS

**LT1763-2.5**  
Output Voltage

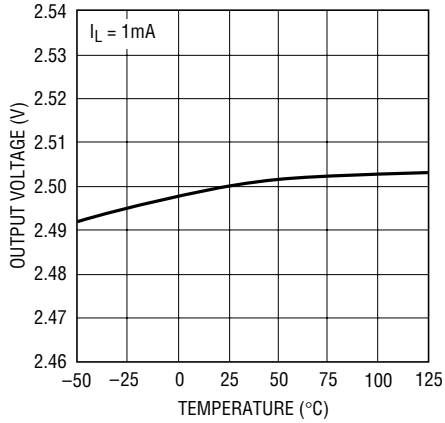

1763 G05

**LT1763-3**  
Output Voltage

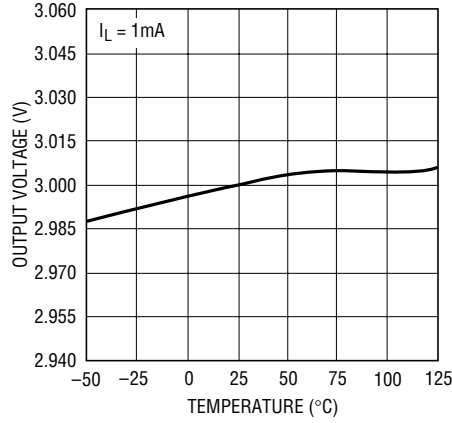

1763 G06

**LT1763-3.3**  
Output Voltage

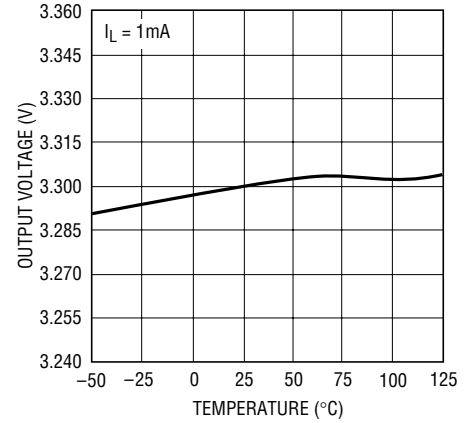

1763 G07

**LT1763-5**  
Output Voltage

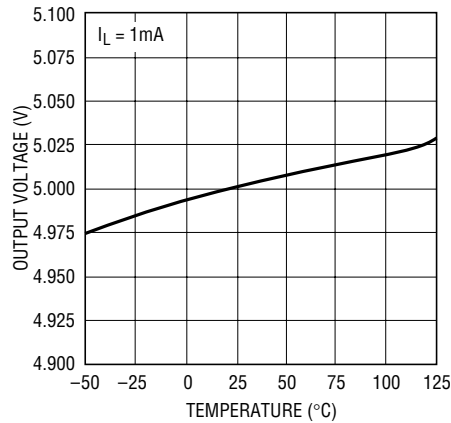

1763 G08

**LT1763**  
ADJ Pin Voltage

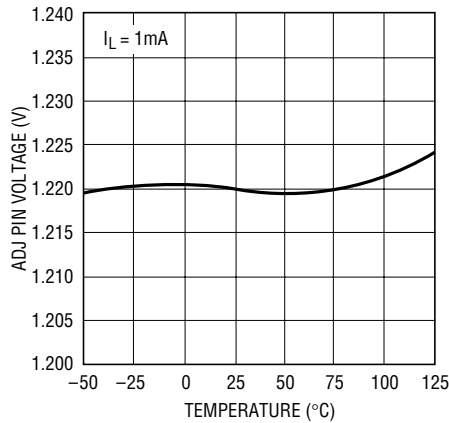

1763 G09

**LT1763-1.5**  
Quiescent Current

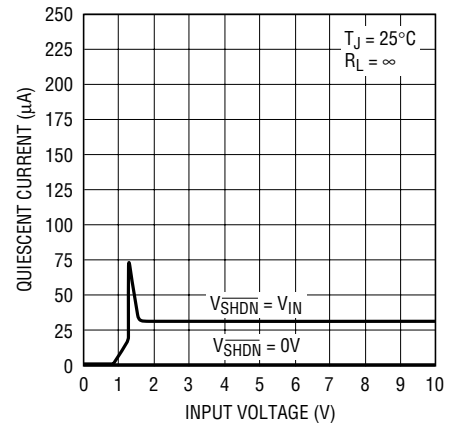

1763 G52

**LT1763-1.8**  
Quiescent Current

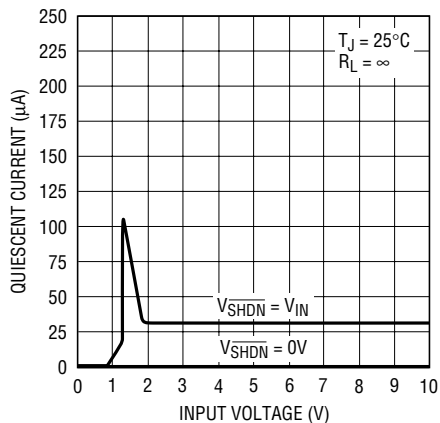

1763 G53

**LT1763-2.5**  
Quiescent Current

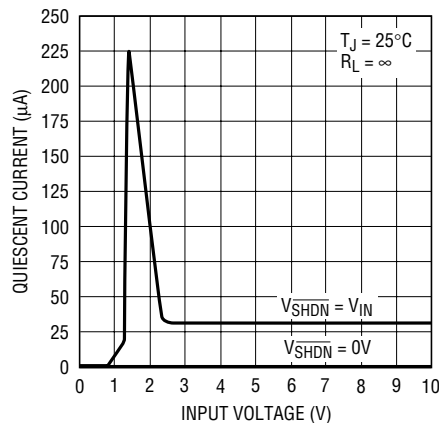

1763 G10

**LT1763-3**  
Quiescent Current

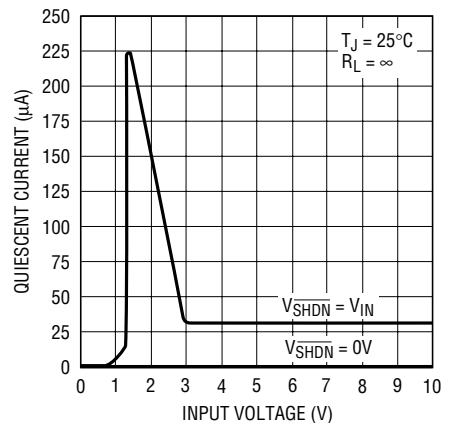

1763 G11

## TYPICAL PERFORMANCE CHARACTERISTICS

**LT1763-3.3**  
Quiescent Current

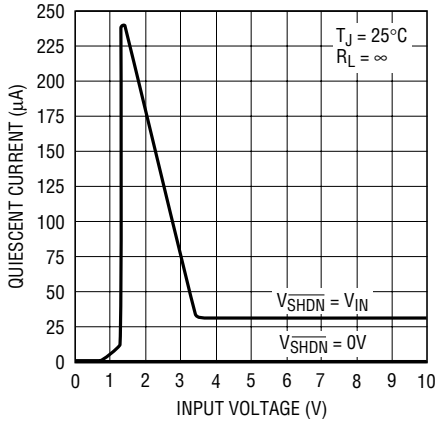

1763 G12

**LT1763-5**  
Quiescent Current

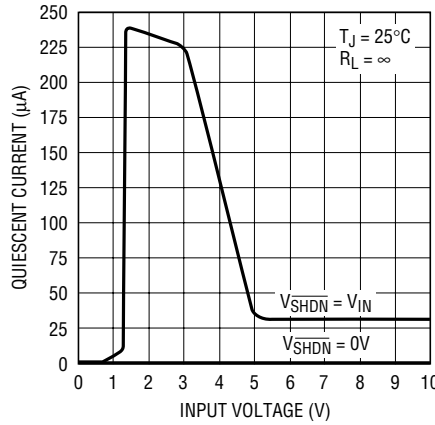

1763 G13

**LT1763**  
Quiescent Current

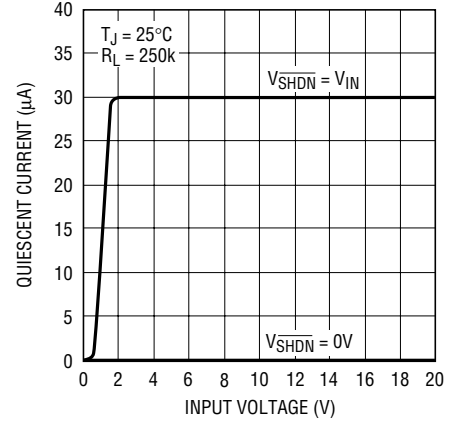

1763 G14

**LT1763-1.5**  
GND Pin Current

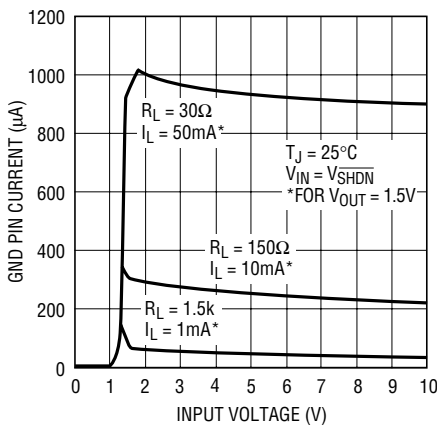

1763 G54

**LT1763-1.8**  
GND Pin Current

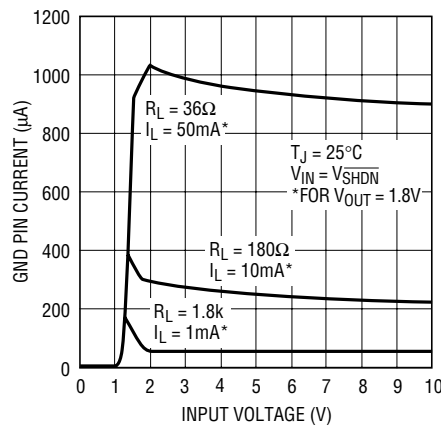

1763 G55

**LT1763-2.5**  
GND Pin Current

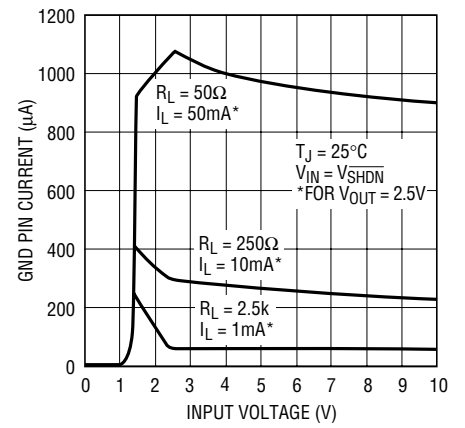

1763 G15

**LT1763-3**  
GND Pin Current

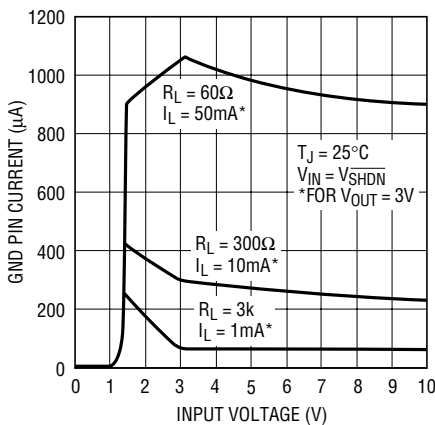

1763 G16

**LT1763-3.3**  
GND Pin Current

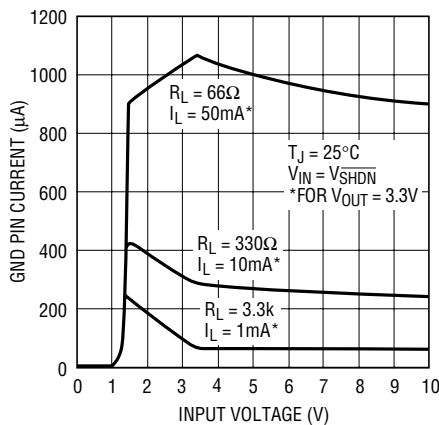

1763 G17

**LT1763-5**  
GND Pin Current

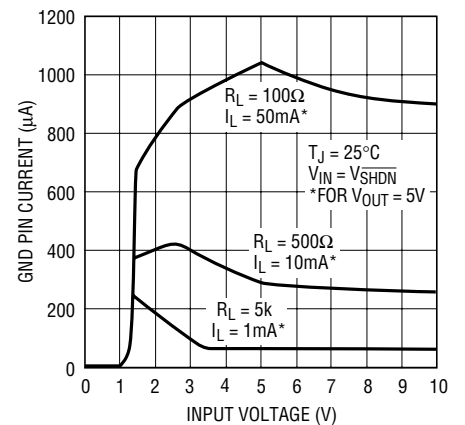

1763 G18

1763fa

# TYPICAL PERFORMANCE CHARACTERISTICS

**LT1763  
GND Pin Current**

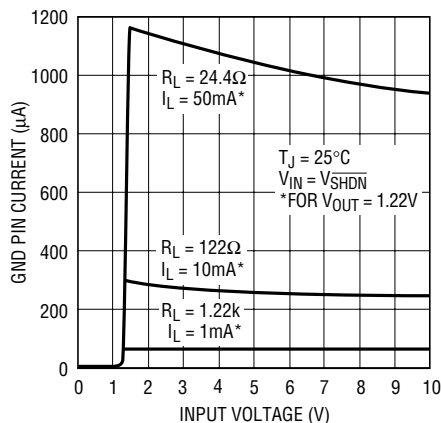

1763 G19

**LT1763-1.5  
GND Pin Current**

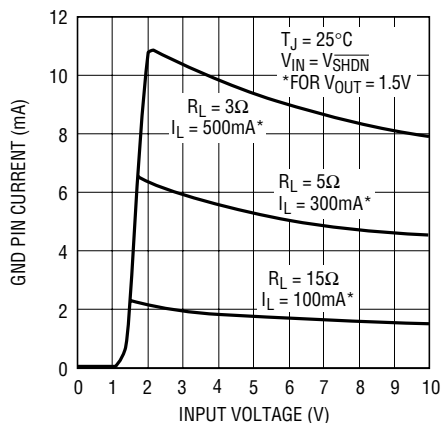

1763 G56

**LT1763-1.8  
GND Pin Current**

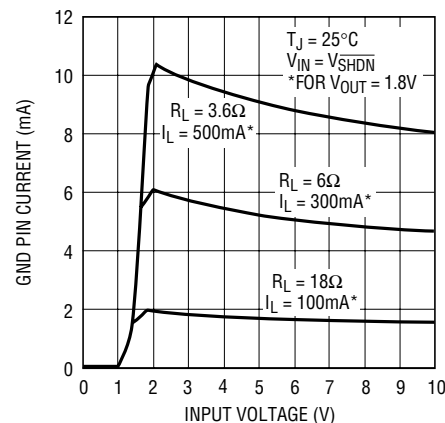

1763 G57

**LT1763-2.5  
GND Pin Current**

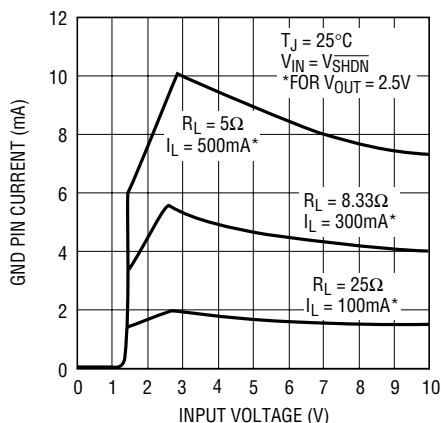

1763 G20

**LT1763-3  
GND Pin Current**

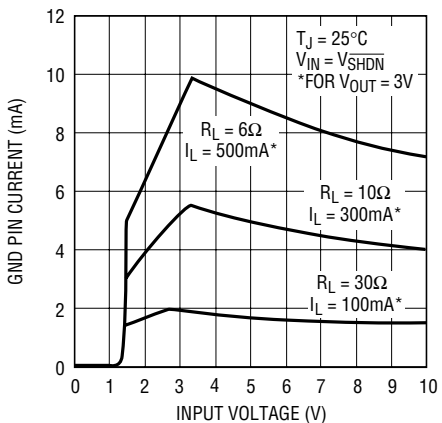

1763 G21

**LT1763-3.3  
GND Pin Current**

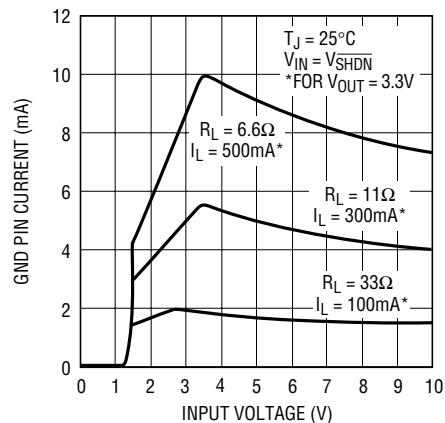

1763 G22

**LT1763-5  
GND Pin Current**

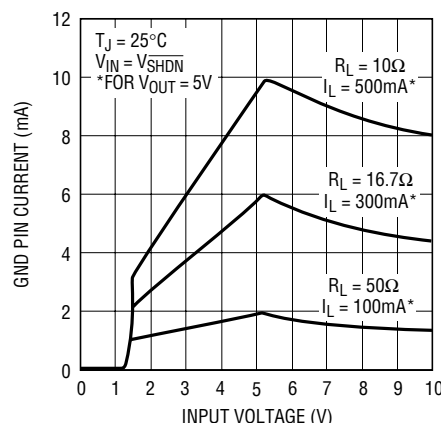

1763 G23

**LT1763  
GND Pin Current**

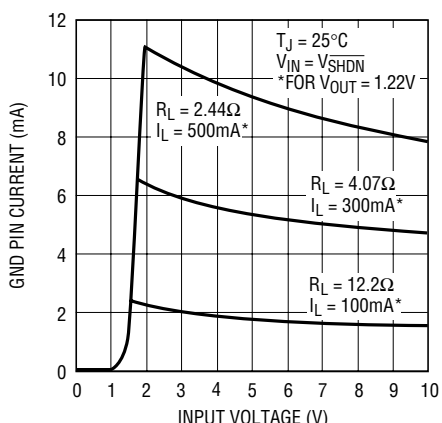

1763 G24

**GND Pin Current vs  $I_{LOAD}$**

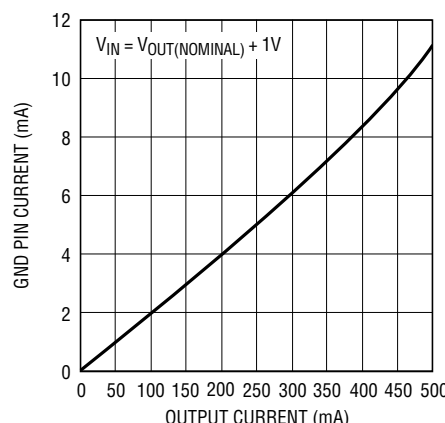

1763 G25

## TYPICAL PERFORMANCE CHARACTERISTICS

**SHDN Pin Threshold (On-to-Off)**

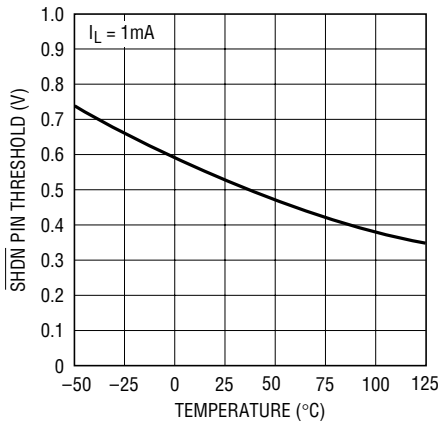

**SHDN Pin Threshold (Off-to-On)**

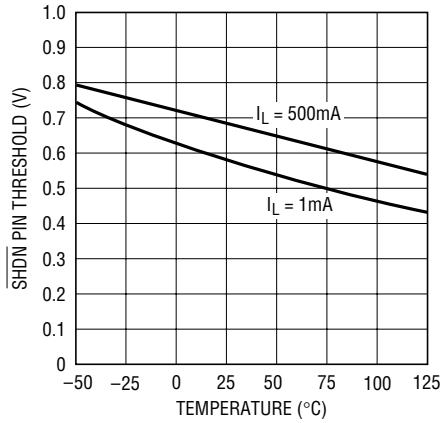

**SHDN Pin Input Current**

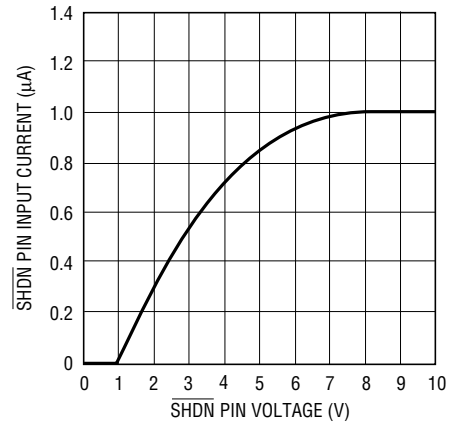

**SHDN Pin Input Current**

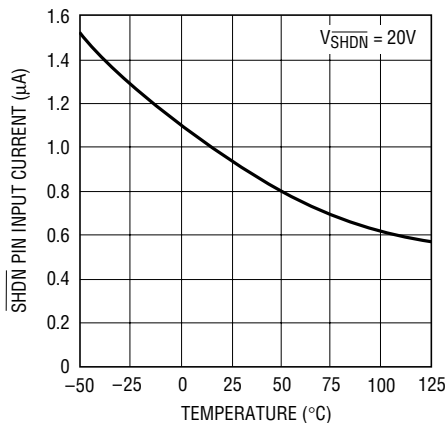

**ADJ Pin Bias Current**

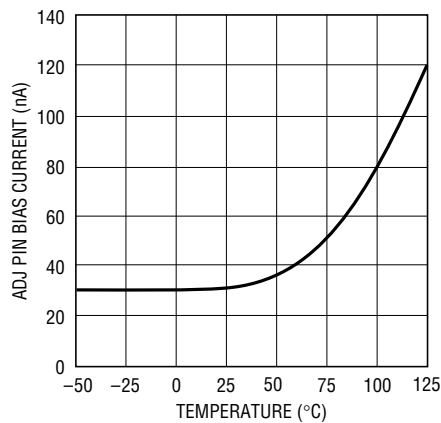

**Current Limit**

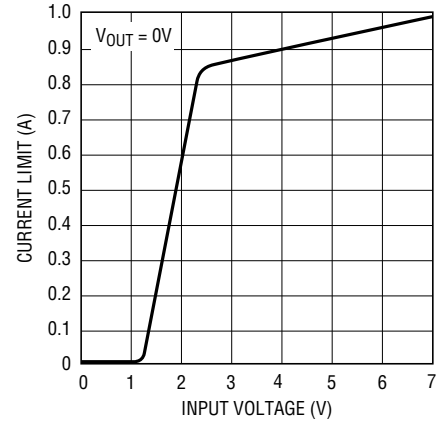

**Current Limit**

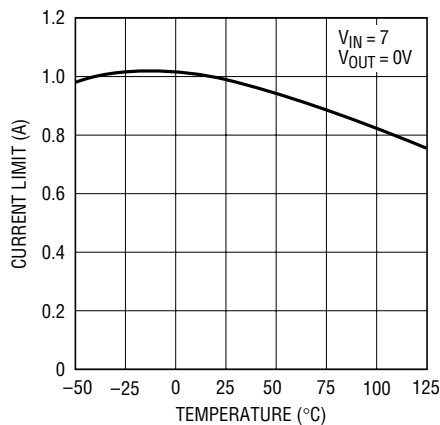

**Reverse Output Current**

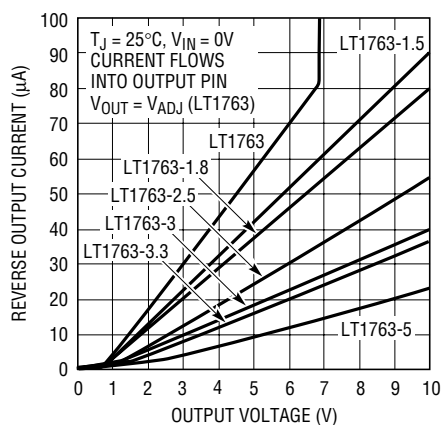

**Reverse Output Current**

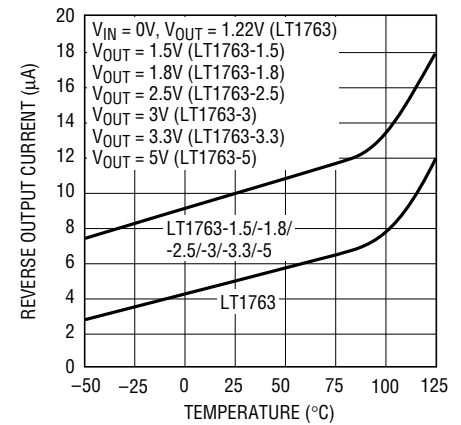



# TYPICAL PERFORMANCE CHARACTERISTICS

**Input Ripple Rejection**

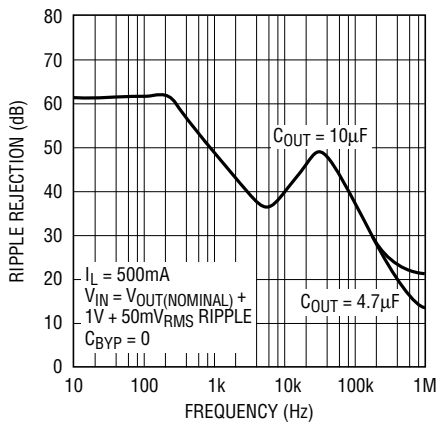

1763 G35

**Input Ripple Rejection**

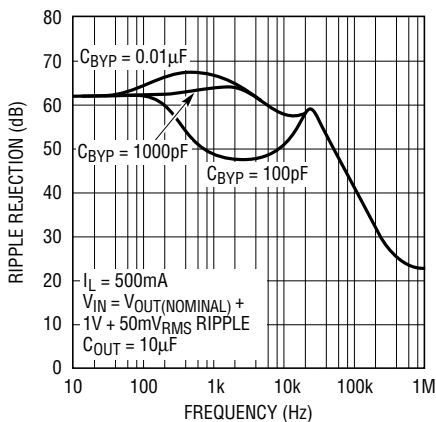

1763 G36

**Ripple Rejection**

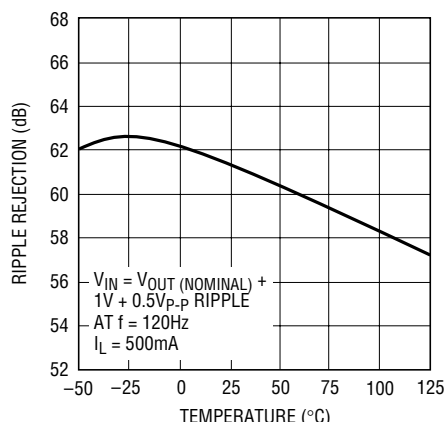

1763 G37

**LT1763 Minimum Input Voltage**

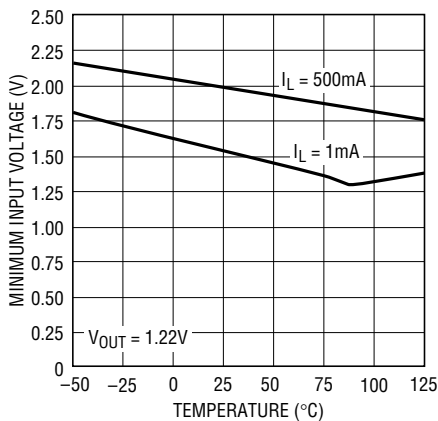

1763 G38

**Load Regulation**

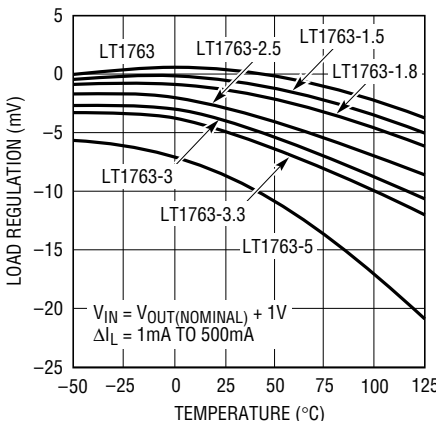

1763 G39

**Output Noise Spectral Density CBYP = 0**

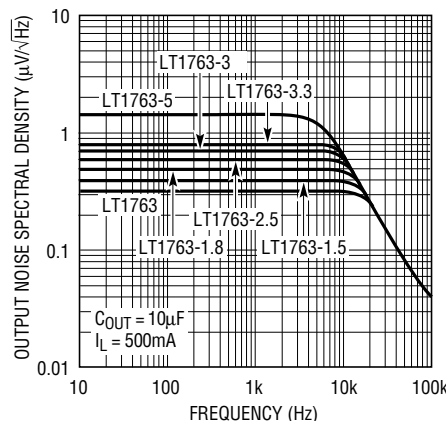

1763 G40

**Output Noise Spectral Density**

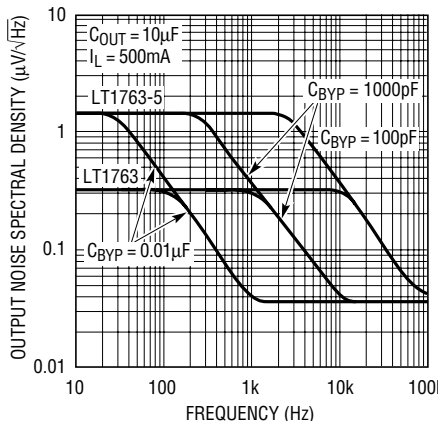

1763 G41

**RMS Output Noise vs Bypass Capacitor**

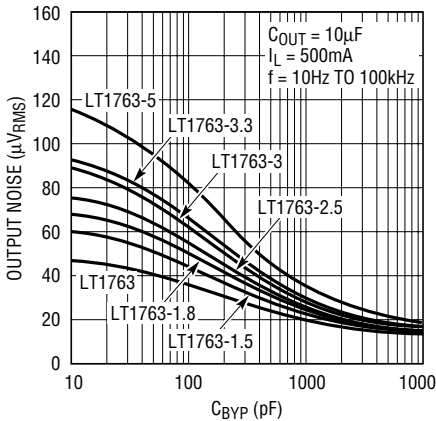

1763 G42

**RMS Output Noise vs Load Current (10Hz to 100kHz)**

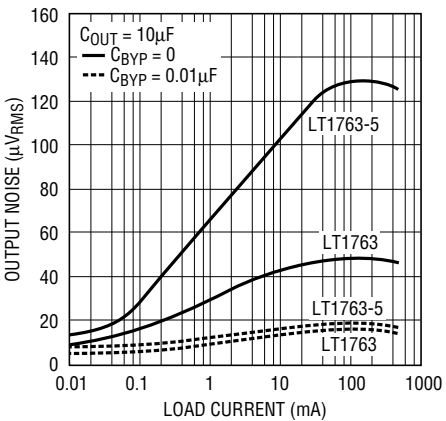

1763 G43

## TYPICAL PERFORMANCE CHARACTERISTICS

**LT1763-5**  
10Hz to 100kHz Output Noise  
 $C_{BYP} = 0$

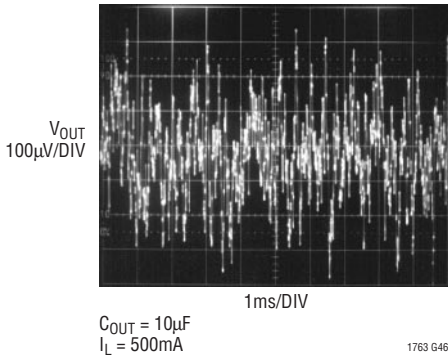

**LT1763-5**  
10Hz to 100kHz Output Noise  
 $C_{BYP} = 100pF$

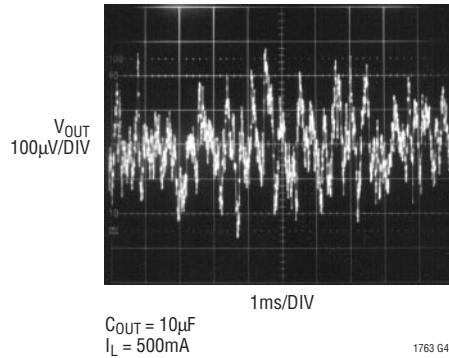

**LT1763-5**  
10Hz to 100kHz Output Noise  
 $C_{BYP} = 1000pF$

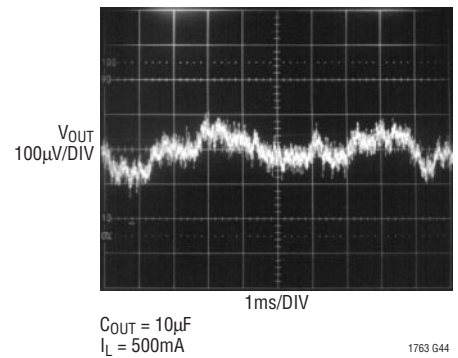

**LT1763-5**  
10Hz to 100kHz Output Noise  
 $C_{BYP} = 0.01µF$

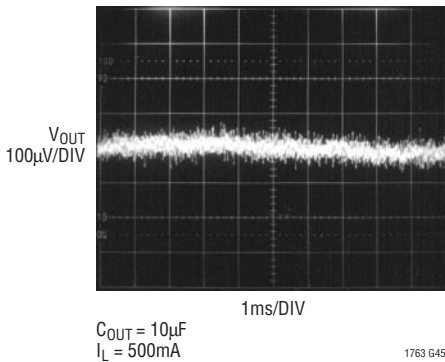

**LT1763-5**  
Transient Response  
 $C_{BYP} = 0$

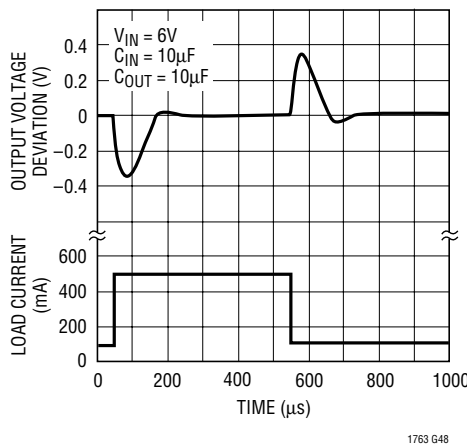

**LT1763-5**  
Transient Response  
 $C_{BYP} = 0.01µF$

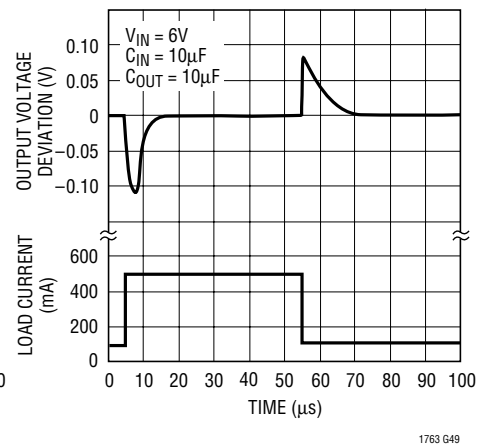

## PIN FUNCTIONS

**OUT (Pin 1):** Output. The output supplies power to the load. A minimum output capacitor of 3.3µF is required to prevent oscillations. Larger output capacitors will be required for applications with large transient loads to limit peak voltage transients. See the Applications Information section for more information on output capacitance and reverse output characteristics.

**SENSE (Pin 2):** Output Sense. For fixed voltage versions of the LT1763 (LT1763-1.5/LT1763-1.8/LT1763-2.5/LT1763-3/LT1763-3.3/LT1763-5), the SENSE pin is the input to the error amplifier. Optimum regulation will be obtained at the point where the SENSE pin is connected to the OUT pin of the regulator. In critical applications, small

voltage drops are caused by the resistance ( $R_P$ ) of PC traces between the regulator and the load. These may be eliminated by connecting the SENSE pin to the output at the load as shown in Figure 1 (Kelvin Sense Connection).

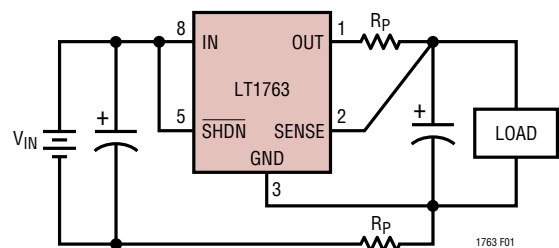

Figure 1. Kelvin Sense Connection

## PIN FUNCTIONS

Note that the voltage drop across the external PC traces will add to the dropout voltage of the regulator. The SENSE pin bias current is 10 $\mu$ A at the nominal rated output voltage. The SENSE pin can be pulled below ground (as in a dual supply system where the regulator load is returned to a negative supply) and still allow the device to start and operate.

**ADJ (Pin 2):** Adjust. For the adjustable LT1763, this is the input to the error amplifier. This pin is internally clamped to  $\pm 7V$ . It has a bias current of 30nA which flows into the pin (see curve of ADJ Pin Bias Current vs Temperature in the Typical Performance Characteristics section). The ADJ pin voltage is 1.22V referenced to ground and the output voltage range is 1.22V to 20V.

**BYP (Pin 4):** Bypass. The BYP pin is used to bypass the reference of the LT1763 regulators to achieve low noise performance from the regulator. The BYP pin is clamped internally to  $\pm 0.6V$  (one  $V_{BE}$ ). A small capacitor from the output to this pin will bypass the reference to lower the output voltage noise. A maximum value of 0.01 $\mu$ F can be used for reducing output voltage noise to a typical 20 $\mu$ V<sub>RMS</sub> over a 10Hz to 100kHz bandwidth. If not used, this pin must be left unconnected.

**GND (Pins 3, 6, 7):** Ground.

**SHDN (Pin 5):** Shutdown. The SHDN pin is used to put the LT1763 regulators into a low power shutdown state. The output will be off when the SHDN pin is pulled low. The SHDN pin can be driven either by 5V logic or open-collector logic with a pull-up resistor. The pull-up resistor is required to supply the pull-up current of the open-collector gate, normally several microamperes, and the SHDN pin current, typically 1 $\mu$ A. If unused, the SHDN pin must be connected to  $V_{IN}$ . The device will be in the low power shutdown state if the SHDN pin is not connected.

**IN (Pin 8):** Input. Power is supplied to the device through the IN pin. A bypass capacitor is required on this pin if the device is more than six inches away from the main input filter capacitor. In general, the output impedance of a battery rises with frequency, so it is advisable to include a bypass capacitor in battery-powered circuits. A bypass capacitor in the range of 1 $\mu$ F to 10 $\mu$ F is sufficient. The LT1763 regulators are designed to withstand reverse voltages on the IN pin with respect to ground and the OUT pin. In the case of a reverse input, which can happen if a battery is plugged in backwards, the device will act as if there is a diode in series with its input. There will be no reverse current flow into the regulator and no reverse voltage will appear at the load. The device will protect both itself and the load.

## APPLICATIONS INFORMATION

The LT1763 series are 500mA low dropout regulators with micropower quiescent current and shutdown. The devices are capable of supplying 500mA at a dropout voltage of 300mV. Output voltage noise can be lowered to 20 $\mu$ V<sub>RMS</sub> over a 10Hz to 100kHz bandwidth with the addition of a 0.01 $\mu$ F reference bypass capacitor. Additionally, the reference bypass capacitor will improve transient response of the regulator, lowering the settling time for transient load conditions. The low operating quiescent current (30 $\mu$ A) drops to less than 1 $\mu$ A in shutdown. In addition to the low quiescent current, the LT1763 regulators incorporate several protection features which make them ideal for use in battery-powered systems. The devices are protected against both reverse input and reverse output voltages. In battery backup applications where the output can be held

up by a backup battery when the input is pulled to ground, the LT1763-X acts like it has a diode in series with its output and prevents reverse current flow. Additionally, in dual supply applications where the regulator load is returned to a negative supply, the output can be pulled below ground by as much as 20V and still allow the device to start and operate.

### Adjustable Operation

The adjustable version of the LT1763 has an output voltage range of 1.22V to 20V. The output voltage is set by the ratio of two external resistors as shown in Figure 2. The device servos the output to maintain the ADJ pin voltage at 1.22V referenced to ground. The current in R1 is then equal to 1.22V/R1 and the current in R2 is the current in R1

## APPLICATIONS INFORMATION

plus the ADJ pin bias current. The ADJ pin bias current, 30nA at 25°C, flows through R2 into the ADJ pin. The output voltage can be calculated using the formula in Figure 2. The value of R1 should be no greater than 250k to minimize errors in the output voltage caused by the ADJ pin bias current. Note that in shutdown the output is turned off and the divider current will be zero. Curves of ADJ Pin Voltage vs Temperature and ADJ Pin Bias Current vs Temperature appear in the Typical Performance Characteristics section.

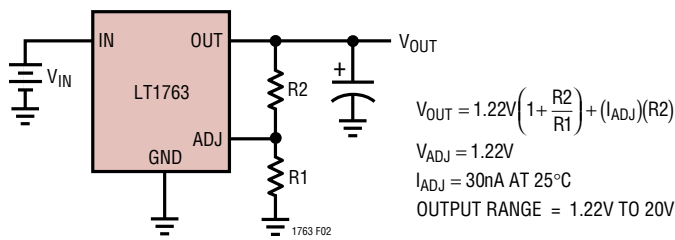

Figure 2. Adjustable Operation

The adjustable device is tested and specified with the ADJ pin tied to the OUT pin for an output voltage of 1.22V. Specifications for output voltages greater than 1.22V will be proportional to the ratio of the desired output voltage to 1.22V:  $V_{OUT}/1.22V$ . For example, load regulation for an output current change of 1mA to 500mA is  $-2mV$  typical at  $V_{OUT} = 1.22V$ . At  $V_{OUT} = 12V$ , load regulation is:

$$(12V/1.22V)(-2mV) = -19.6mV$$

### Bypass Capacitance and Low Noise Performance

The LT1763 regulators may be used with the addition of a bypass capacitor from  $V_{OUT}$  to the BYP pin to lower output voltage noise. A good quality low leakage capacitor is recommended. This capacitor will bypass the reference of the regulator, providing a low frequency noise pole. The noise pole provided by this bypass capacitor will lower the output voltage noise to as low as  $20\mu V_{RMS}$  with the addition of a  $0.01\mu F$  bypass capacitor. Using a bypass capacitor has the added benefit of improving transient response. With no bypass capacitor and a  $10\mu F$  output capacitor, a 10mA to 500mA load step will settle to within 1% of its final value in less than  $100\mu s$ . With the addition of a  $0.01\mu F$  bypass capacitor, the output will settle to within 1% for a 10mA to 500mA load step in less than

$10\mu s$ , with total output voltage deviation of less than 2.5% (see LT1763-5 Transient Response in the Typical Performance Characteristics). However, regulator start-up time is inversely proportional to the size of the bypass capacitor, slowing to 15ms with a  $0.01\mu F$  bypass capacitor and  $10\mu F$  output capacitor.

### Output Capacitance and Transient Response

The LT1763 regulators are designed to be stable with a wide range of output capacitors. The ESR of the output capacitor affects stability, most notably with small capacitors. A minimum output capacitor of  $3.3\mu F$  with an ESR of  $3\Omega$  or less is recommended to prevent oscillations. The LT1763-X is a micropower device and output transient response will be a function of output capacitance. Larger values of output capacitance decrease the peak deviations and provide improved transient response for larger load current changes. Bypass capacitors, used to decouple individual components powered by the LT1763-X, will increase the effective output capacitor value. With larger capacitors used to bypass the reference (for low noise operation), larger values of output capacitors are needed. For 100pF of bypass capacitance,  $4.7\mu F$  of output capacitor is recommended. With a 1000pF bypass capacitor or larger, a  $6.8\mu F$  output capacitor is recommended.

The shaded region of Figure 3 defines the range over which the LT1763 regulators are stable. The minimum ESR needed is defined by the amount of bypass capacitance used, while the maximum ESR is  $3\Omega$ .

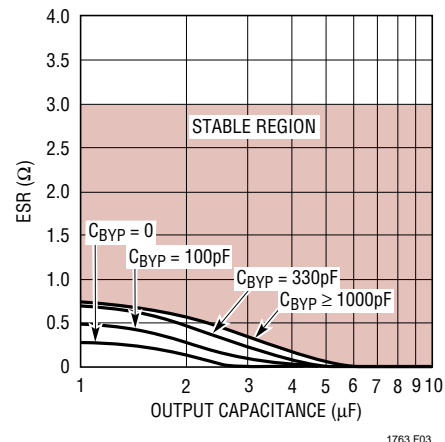

Figure 3. Stability

## APPLICATIONS INFORMATION

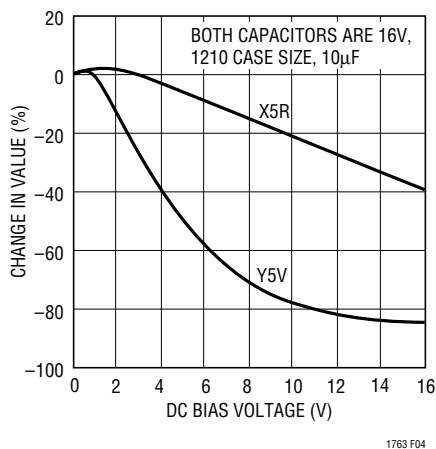

Figure 4. Ceramic Capacitor DC Bias Characteristics

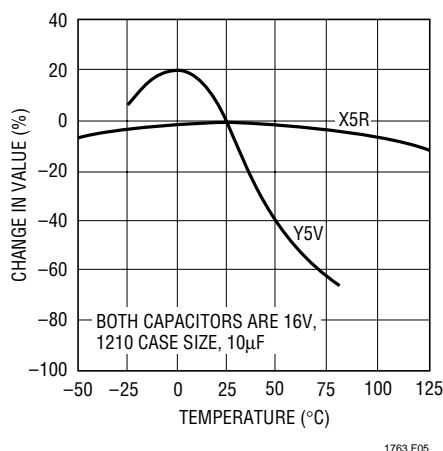

Figure 5. Ceramic Capacitor Temperature Characteristics

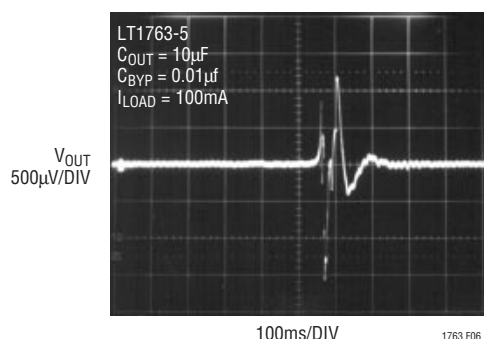

Figure 6. Noise Resulting from Tapping on a Ceramic Capacitor

Extra consideration must be given to the use of ceramic capacitors. Ceramic capacitors are manufactured with a variety of dielectrics, each with different behavior across temperature and applied voltage. The most common dielectrics used are Z5U, Y5V, X5R and X7R. The Z5U and Y5V dielectrics are good for providing high capacitances in a small package, but exhibit strong voltage and temperature coefficients as shown in Figures 4 and 5. When used with a 5V regulator, a 10µF Y5V capacitor can exhibit an effective value as low as 1µF to 2µF over the operating temperature range. The X5R and X7R dielectrics result in more stable characteristics and are more suitable for use as the output capacitor. The X7R type has better stability across temperature, while the X5R is less expensive and is available in higher values.

Voltage and temperature coefficients are not the only sources of problems. Some ceramic capacitors have a piezoelectric response. A piezoelectric device generates voltage across its terminals due to mechanical stress, similar to the way a piezoelectric accelerometer or microphone works. For a ceramic capacitor the stress can be induced by vibrations in the system or thermal transients. The resulting voltages produced can cause appreciable amounts of noise, especially when a ceramic capacitor is used for noise bypassing. A ceramic capacitor produced Figure 6’s trace in response to light tapping from a pencil. Similar vibration induced behavior can masquerade as increased output voltage noise.

### Thermal Considerations

The power handling capability of the device will be limited by the maximum rated junction temperature (125°C). The power dissipated by the device will be made up of two components:

1. Output current multiplied by the input/output voltage differential:  $(I_{OUT})(V_{IN} - V_{OUT})$ , and
2. GND pin current multiplied by the input voltage:  $(I_{GND})(V_{IN})$ .

The GND pin current can be found by examining the GND Pin Current curves in the Typical Performance Characteristics. Power dissipation will be equal to the sum of the two components listed above.

## APPLICATIONS INFORMATION

The LT1763 series regulators have internal thermal limiting designed to protect the device during overload conditions. For continuous normal conditions, the maximum junction temperature rating of 125°C must not be exceeded. It is important to give careful consideration to all sources of thermal resistance from junction to ambient. Additional heat sources mounted nearby must also be considered.

For surface mount devices, heat sinking is accomplished by using the heat spreading capabilities of the PC board and its copper traces. Copper board stiffeners and plated through-holes can also be used to spread the heat generated by power devices.

The following table lists thermal resistance for several different board sizes and copper areas. All measurements were taken in still air on 3/32" FR-4 board with one ounce copper.

**Table 1. Measured Thermal Resistance**

| COPPER AREA         |                     | BOARD AREA          | THERMAL RESISTANCE<br>(JUNCTION-TO-AMBIENT) |
|---------------------|---------------------|---------------------|---|
| TOPSIDE*            | BACKSIDE            |                     |   |
| 2500mm <sup>2</sup> | 2500mm <sup>2</sup> | 2500mm <sup>2</sup> | 60°C/W                                      |
| 1000mm <sup>2</sup> | 2500mm <sup>2</sup> | 2500mm <sup>2</sup> | 60°C/W                                      |
| 225mm <sup>2</sup>  | 2500mm <sup>2</sup> | 2500mm <sup>2</sup> | 68°C/W                                      |
| 100mm <sup>2</sup>  | 2500mm <sup>2</sup> | 2500mm <sup>2</sup> | 74°C/W                                      |
| 50mm <sup>2</sup>   | 2500mm <sup>2</sup> | 2500mm <sup>2</sup> | 86°C/W                                      |

\*Device is mounted on topside.

### Calculating Junction Temperature

Example: Given an output voltage of 3.3V, an input voltage range of 4V to 6V, an output current range of 0mA to 250mA and a maximum ambient temperature of 50°C, what will the maximum junction temperature be?

The power dissipated by the device will be equal to:

$$I_{OUT(MAX)}(V_{IN(MAX)} - V_{OUT}) + I_{GND}(V_{IN(MAX)})$$

where,

$$I_{OUT(MAX)} = 250\text{mA}$$

$$V_{IN(MAX)} = 6\text{V}$$

$$I_{GND} \text{ at } (I_{OUT} = 250\text{mA}, V_{IN} = 6\text{V}) = 5\text{mA}$$

So,

$$P = 250\text{mA}(6\text{V} - 3.3\text{V}) + 5\text{mA}(6\text{V}) = 0.71\text{W}$$

The thermal resistance will be in the range of 60°C/W to 86°C/W depending on the copper area. So the junction temperature rise above ambient will be approximately equal to:

$$0.71\text{W}(75^\circ\text{C/W}) = 53.3^\circ\text{C}$$

The maximum junction temperature will then be equal to the maximum junction temperature rise above ambient plus the maximum ambient temperature or:

$$T_{JMAX} = 50^\circ\text{C} + 53.3^\circ\text{C} = 103.3^\circ\text{C}$$

### Protection Features

The LT1763 regulators incorporate several protection features which make them ideal for use in battery-powered circuits. In addition to the normal protection features associated with monolithic regulators, such as current limiting and thermal limiting, the devices are protected against reverse input voltages, reverse output voltages and reverse voltages from output to input.

Current limit protection and thermal overload protection are intended to protect the device against current overload conditions at the output of the device. For normal operation, the junction temperature should not exceed 125°C.

The input of the device will withstand reverse voltages of 20V. Current flow into the device will be limited to less than 1mA (typically less than 100µA) and no negative voltage will appear at the output. The device will protect both itself and the load. This provides protection against batteries which can be plugged in backward.

The output of the LT1763-X can be pulled below ground without damaging the device. If the input is left open circuit or grounded, the output can be pulled below ground by 20V. For fixed voltage versions, the output will act like a large resistor, typically 500kΩ or higher, limiting current flow to less than 100µA. For adjustable versions, the output will act like an open circuit; no current will flow out of the pin. If the input is powered by a voltage source, the output will source the short-circuit current of the device and will protect itself by thermal limiting. In this case, grounding the SHDN pin will turn off the device and stop the output from sourcing the short-circuit current.

## APPLICATIONS INFORMATION

The ADJ pin of the adjustable device can be pulled above or below ground by as much as 7V without damaging the device. If the input is left open circuit or grounded, the ADJ pin will act like an open circuit when pulled below ground and like a large resistor (typically 100k) in series with a diode when pulled above ground.

In situations where the ADJ pin is connected to a resistor divider that would pull the ADJ pin above its 7V clamp voltage if the output is pulled high, the ADJ pin input current must be limited to less than 5mA. For example, a resistor divider is used to provide a regulated 1.5V output from the 1.22V reference when the output is forced to 20V. The top resistor of the resistor divider must be chosen to limit the current into the ADJ pin to less than 5mA when the ADJ pin is at 7V. The 13V difference between output and ADJ pin divided by the 5mA maximum current into the ADJ pin yields a minimum top resistor value of 2.6k.

In circuits where a backup battery is required, several different input/output conditions can occur. The output voltage may be held up while the input is either pulled to ground, pulled to some intermediate voltage or is left open circuit. Current flow back into the output will follow the curve shown in Figure 7.

When the IN pin of the LT1763-X is forced below the OUT pin or the OUT pin is pulled above the IN pin, input current will typically drop to less than 2μA. This can happen if the input of the device is connected to a discharged (low voltage) battery and the output is held up by either a backup battery or a second regulator circuit. The state of the SHDN pin will have no effect on the reverse output current when the output is pulled above the input.

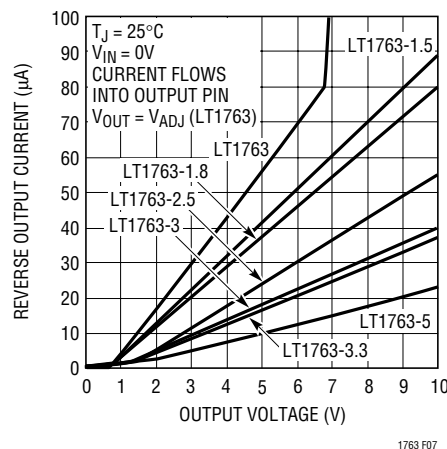
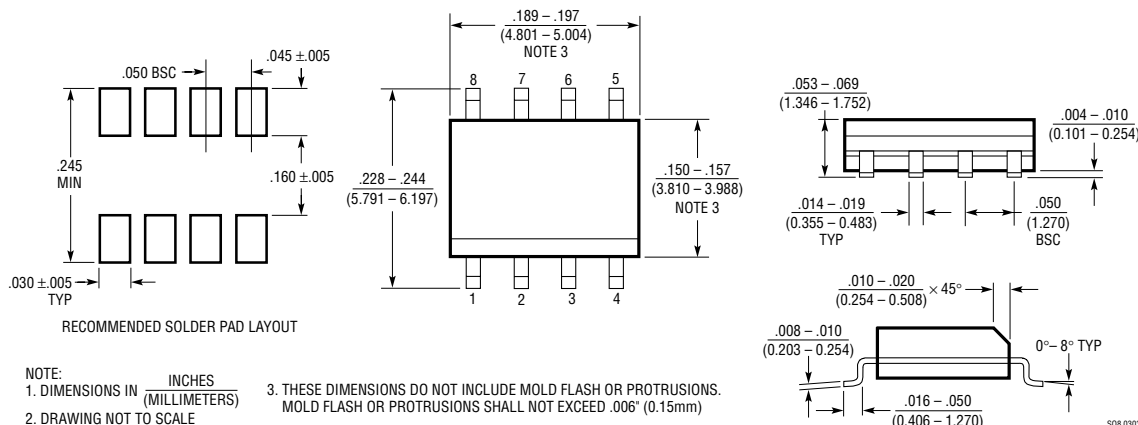

Figure 7. Reverse Output Current

## TYPICAL APPLICATION

### S8 Package 8-Lead Plastic Small Outline (Narrow .150 Inch) (Reference LTC DWG # 05-08-1610)



## TYPICAL APPLICATION

Paralleling of Regulators for Higher Output Current

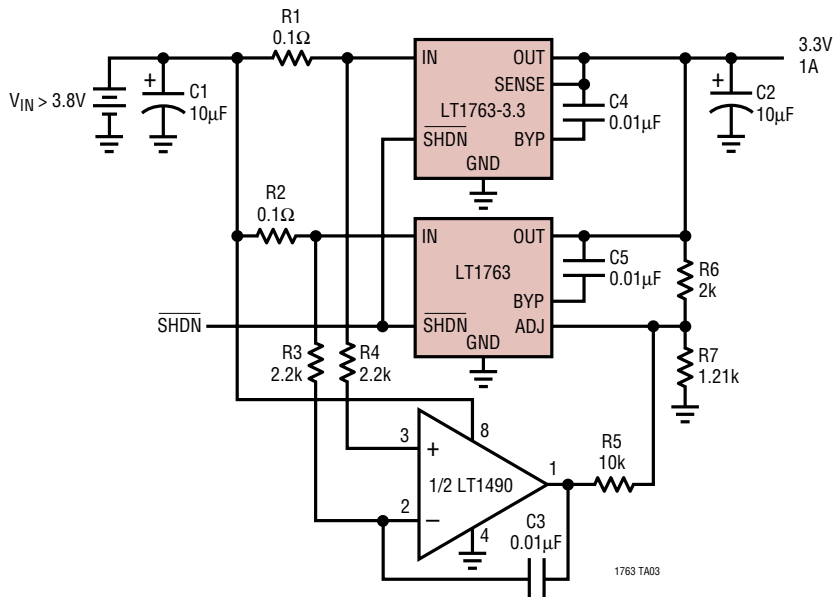

## RELATED PARTS

| PART NUMBER   | DESCRIPTION   | COMMENTS  |
|---------------|---|---|
| LT1120        | 125mA Low Dropout Regulator with 20μA I <sub>Q</sub>          | Includes 2.5V Reference and Comparator                              |
| LT1121        | 150mA Micropower Low Dropout Regulator                        | 30μA I <sub>Q</sub> , SOT-223 Package                               |
| LT1129        | 700mA Micropower Low Dropout Regulator                        | 50μA Quiescent Current  |
| LT1175        | 500mA Negative Low Dropout Micropower Regulator               | 45μA I <sub>Q</sub> , 0.26V Dropout Voltage, SOT-223 Package        |
| LT1521        | 300mA Low Dropout Micropower Regulator with Shutdown          | 15μA I <sub>Q</sub> , Reverse Battery Protection                    |
| LT1529        | 3A Low Dropout Regulator with 50μA I <sub>Q</sub>             | 500mV Dropout Voltage   |
| LT1613        | 1.4MHz Single-Cell Micropower DC/DC Converter                 | SOT-23 Package, Internally Compensated                              |
| LT1761 Series | 100mA, Low Noise, Low Dropout Micropower Regulators in SOT-23 | 20μA Quiescent Current, 20μV <sub>RMS</sub> Noise, ThinSOT          |
| LT1762 Series | 150mA, Low Noise, LDO Micropower Regulators                   | 25μA Quiescent Current, 20μV <sub>RMS</sub> Noise, MS8              |
| LT1764A       | 3A, Fast Transient Response Low Dropout Regulator             | 340mV Dropout Voltage, DD, TO220                                    |
| LT1962        | 300mA, Fast Transient Response Low Dropout Regulator          | 270mV Dropout Voltage, 20μV <sub>RML</sub> , MS8                    |
| LT1963A       | 1.5A, Fast Transient Response Low Dropout Regulator           | 340mV Dropout Voltage, 40μV <sub>RML</sub> , DD, TO220, S8, SOT-223 |
| LT3010        | 50mA, 80V Low Noise, LDO Micropower Regulator                 | 300mV Dropout Voltage, MS8E   |



This datasheet has been downloaded from:

[www.DatasheetCatalog.com](http://www.DatasheetCatalog.com)

Datasheets for electronic components.