

EE771/EE772 Inline Flowmeter for compressed air and gases DN15 (1/2") - DN80 (3")

The inline flow meter EE771/EE772, based on the measurement principle of thermal mass flow, is ideally suited for the measurement of flow in pipelines DN15 (1/2") up to DN80 (3"). Measurement of for instance the usage of compressed air, nitrogen, CO₂, oxygen, helium or other non-corrosive, non-flammable gasses.

The flowmeters are setting new standards in terms of measurement accuracy and reproducibility thanks to their application-specific adjustment during production. As such, the EE771/EE772 is adjusted under a pressure of 7 bar.

The unique mounting concept with a mounting valve permits rapid installation and removal of the device for periodical calibration. It simultaneously ensures high measurement accuracy through exact and reproducible positioning in the pipe.

The core design of the flow meter is based on the E+E hot film sensor element, which is produced using the most modern thin film technology. This flow sensor features excellent long-term stability, a fast response time and an extremely high degree of reliability.

Two outputs are available, for further processing of the measurement data. Depending on the application, these outputs can be configured as analogue (current or voltage), switch output or as pulse output for the measurement of the consumption.

Bus interface for Modbus RTU or M-Bus

Optionally, the flow meter is available with an additional bus interface for MODBUS RTU or M-BUS (Meter-Bus).

Configuration software

The flowmeter can be configured conveniently, to meet the requirements of the application with the standard configuration software and the integrated USB interface.

Functionality of the software:

- Configuration of the output (scale / set point)
- 2-point user calibration for flow and temperature
- Readout of the counter values
- Reset of min / max values and counter
- Indication of the measurement value

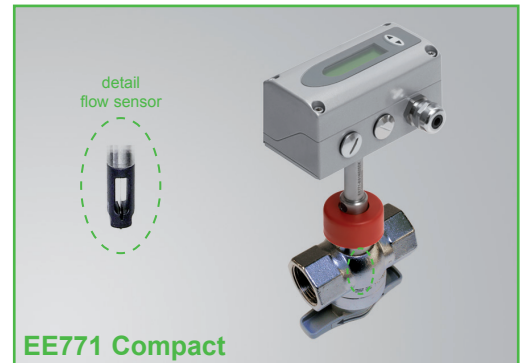

EE771 Compact



EE772 remote probe

Attribute	EE771	EE772
Sensor exchange under pressure with short flow interruption	✓	
Sensor exchange under pressure without flow interruption		✓
pipeline DN15...DN50 (1/2"...2")	✓	
pipeline DN40...DN80 (1 1/2"...3")		✓
Additional assembly of dew point- and pressure sensors		✓
max. working pressure 16 bar 232 PSI	✓	✓
max. working pressure 40 bar 580 PSI		✓

Typical Applications

- Measurement of consumption of compressed air
- Compressed air counter
- Mass flow measurement of industrial gases

Features

- high accuracy ± 1.5% of reading
- exceptional reproducibility
- quick sensor exchange at line pressure
- broad working range of 1 : 400
- very service friendly
- Bus interface for Modbus RTU or M-Bus

EE771 - Assembly with ball valve

The ball valve assembly allows for the exact alignment of the sensing head within seconds during installation and removal, with only interrupting the process flow for a short moment.

The ball valve assembly is suitable for pressures up to 16 bar (232 PSI) and available for pipe diameters DN15 (1/2") to DN50 (2").



EE772 - Assembly with MultiController

The unique assembly concept with one mounting valve permits simple installation and removal of the sensors for regular calibration, and also ensures a high level of measurement accuracy via precise and reproducible positioning of the flow sensor in the pipeline.

The MultiController with hot tap valve is used in applications where flow interruption is not permissible. The flowmeter can be removed for calibration or maintenance with no flow interruption.

The MultiController assembly is suitable for applications up to 40 bar (PN40) and is available for line sizes of DN40 (1 1/2") to DN80 (3").

The additional option of integrating dewpoint or pressure sensors saves on installation costs. The MultiController mounting valve makes it easy to set up a comprehensive compressed air monitoring system.

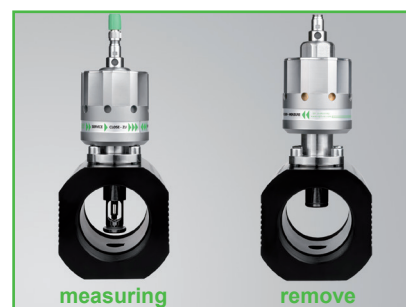

Construction

The flow meter consists of the transmitter and the mounting valve. The transmitter is modular and consists of the probe and the evaluation electronics. The measurement probe contains the sensor element and the measurement electronics, in which the data of the factory calibration is stored. The enclosure with the signal conditioning is mounted either on the measurement probe (compact) or is remote with a sensor cable up to 10 meter (33 feet).

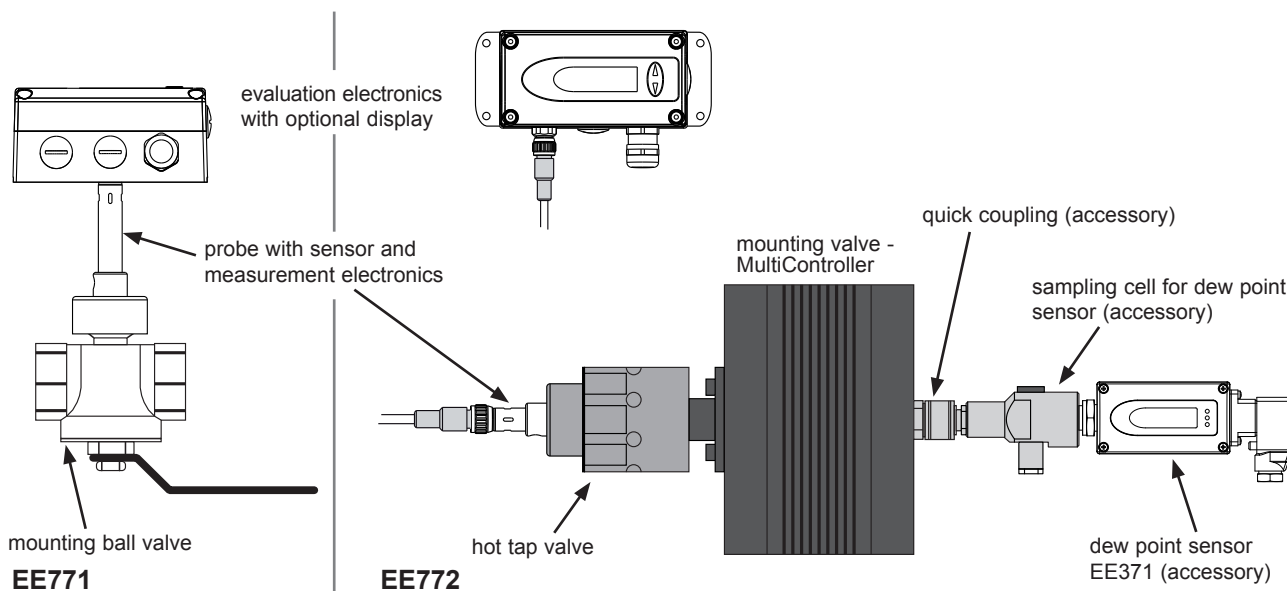

Measurement of consumption (totalizer)

The EE771/EE772 holds an integrated counter for the usage. The amount is indicated in the display and stored; the data will not be lost due to a power outage. The availability of the consumption amount as a free configurable pulse output is another helpful feature.

Dimensions in mm (inch)

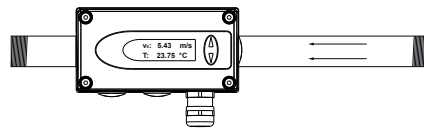
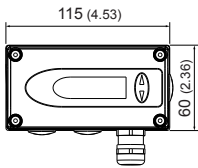

EE77x-A direction of flow is right to left

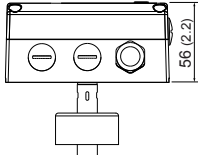

EE77x-A / EE77x-B
Compact

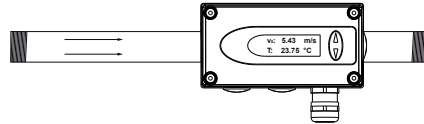

EE77x-B direction of flow is left to right

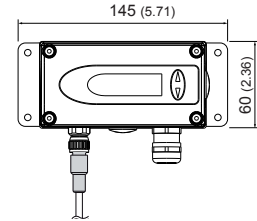

EE77x-C
Remote probe

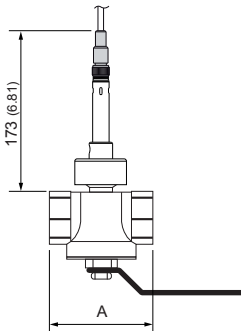

HA075xxx
Mounting ball valve

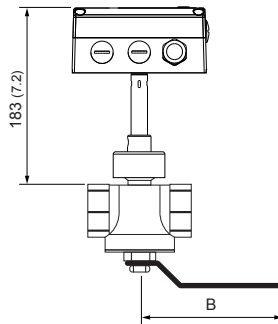

ball valve	Thread	A	B
DN15	R _p 1/2"	83.7 (3.3)	35 (1.38)
DN20	R _p or NPT 3/4"	72.7 (2.84)	35 (1.38)
DN25	R _p or NPT 1"	88 (3.46)	47.5 (1.87)
DN32	R _p 1 1/4"	100 (3.94)	120 (4.72)
DN40	R _p or NPT 1 1/2"	110 (4.33)	150 (5.91)
DN50	R _p or NPT 2"	131 (5.16)	150 (5.91)

dimensions in mm (inch)

Female thread:

BSP thread acc. EN 10226 (old DIN 2999) or NPT

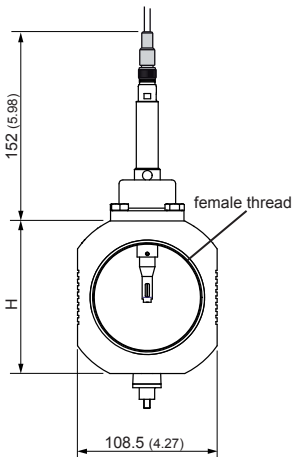

HA071xxx
Mounting MultiController

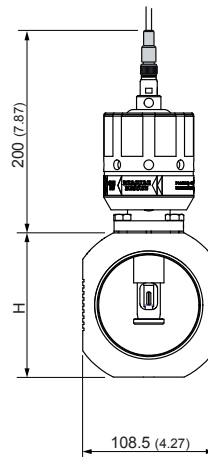
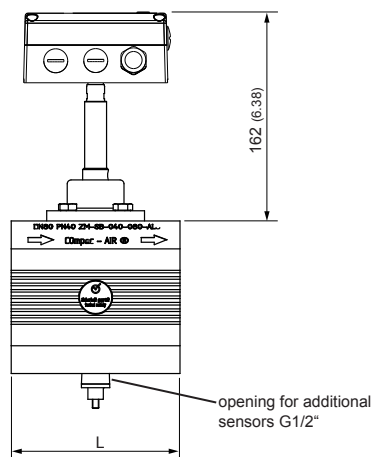

HA072xxx
Mounting MultiController with hot tap valve

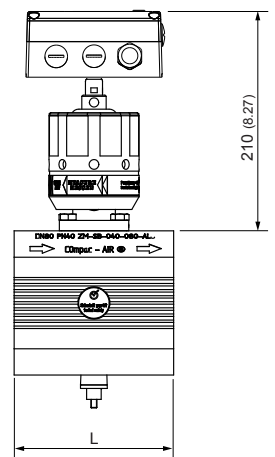

pipe diameter	Thread	L	H
DN40 (1 1/2")	R _p or NPT 1 1/2"	110 (4.33)	108.5 (4.27)
DN50 (2")	R _p or NPT 2"	131 (5.16)	108.5 (4.27)
DN65 (2 1/2")	R _p or NPT 2 1/2"	131 (5.16)	108.5 (4.27)
DN80 (3")	R _p or NPT 3"	131 (5.16)	118.5 (4.67)

dimensions in mm (inch)

female thread:

Whitworth-Thread acc. EN 10226 (old DIN 2999) or NPT

Technische Daten

Measuring value

Flow

Measurand	Volumetric flow at standard conditions acc. DIN 1343 $P_0 = 1013.25 \text{ mbar (14.7 PSI); } t_0 = 0 \text{ }^\circ\text{C (32}^\circ\text{F)}$			
Measuring range	low (L1)		high (H1)	
standardized volumetric flow in air	DN15 (1/2"):	0.32...63 Nm ³ /h 0.19...37.1 SCFM	0.32...126 Nm ³ /h	0.19...74.1 SCFM
	DN20 (3/4"):	0.57...113 Nm ³ /h 0.34...66.5 SCFM	0.57...226 Nm ³ /h	0.34...133 SCFM
	DN25 (1"):	0.90...176 Nm ³ /h 0.53...103.5 SCFM	0.90...352 Nm ³ /h	0.53...207.1 SCFM
	DN32 (1 1/4"):	1.45...289 Nm ³ /h 0.85...170.0 SCFM	1.45...578 Nm ³ /h	0.85...340 SCFM
	DN40 (1 1/2"):	2.26...452 Nm ³ /h 1.33...265.9 SCFM	2.26...904 Nm ³ /h	1.33...531.8 SCFM
	DN50 (2"):	3.50...700 Nm ³ /h 2.06...411.8 SCFM	3.50...1400 Nm ³ /h	2.06...823.6 SCFM
	DN65 (2 1/2"):		5.97...1400 Nm ³ /h	3.51...823.6 SCFM
	DN80 (3"):		9.04...1400 Nm ³ /h	5.32...823.6 SCFM
standardized flow in air, CO ₂ , nitrogen, argon	≤DN50 (2"):	0.5...100 Nm/s 100...19685 SFPM	0.5...200 Nm/s	100...39370 SFPM
	DN65 (2 1/2"):		0.5...117 Nm/s	100...23031 SFPM
	DN80 (3"):		0.5...77 Nm/s	100...15157 SFPM
helium	≤DN50 (2"):	0.5...100 Nm/s 100...19685 SFPM	0.5...120 Nm/s	100...23622 SFPM
	DN65 (2 1/2"):		0.5...117 Nm/s	100...23031 SFPM
	DN80 (3"):		0.5...77 Nm/s	100...15157 SFPM
oxygen	≤DN25 (1"):	0.5...100 Nm/s 100...19685 SFPM	0.5...200 Nm/s	100...39370 SFPM
Accuracy in air at 7bar (101.5 Psi) (abs) and 23°C (73°F) ¹⁾	± (1.5% of measuring value + 0.5% of full scale)			
Temperature coefficient	± (0.1% of measuring value/°C)			
Pressure coefficient ²⁾	0.5% of measuring value / bar			
Response time t_{90}	< 1 sec.			
Sample rate	0.5 sec.			
Temperature				
Measuring range	-20...80 °C (-4...176 °F)			
Accuracy at 20°C (68°F)	± 0.7 °C (1.26 °F)			

Outputs

Output signal and display ranges are freely scalable			
Analogue output	voltage	0 - 10 V	max. 1 mA
	current (3-wire)	0 - 20 mA and 4 - 20 mA	$R_L < 500 \text{ Ohm}$
Switching output	potential-free max. 44 VDC, 500 mA switching capacity		
Pulse output	Totalizer, pulse length: 0.02...2 sec.		
Bus interface (optional)	MODBUS RTU or M-BUS (Meter-Bus)		
Digital interface	USB (for configuration)		

Input

Optional pressure compensation	4 - 20 mA (2-wire; 15 V) for pressure sensor
--------------------------------	--

General

Supply voltage	18 - 30 V AC/DC	
Current consumption	max. 200 mA (with display)	
Temperature range	ambient temperature:	-20...60 °C (-4...140 °F)
	medium temperature:	-20...80 °C (-4...176 °F)
	storage temperature:	-20...60 °C (-4...140 °F)
Nominal pressure	EE771 up to 16 bar (232 Psi)	
	EE772 up to 40 bar (580 Psi)	
Humidity	no condensation	
Medium	compressed air or none corrosive gases	
Connection	cable gland M16x1.5 (optional connector M12x1.8pol.)	
Electromagnetic compatibility	EN61326-1	EN61326-2-3
	Industrial Environment	
Material	housing	metal (AlSi3Cu)
	probe	stainless steel
	sensor head	plastic (PBT)
	ball valve	brass
	MultiController	Aluminium
Housing protection class	IP65 / Nema 4	



1) The accuracy statement includes the uncertainty of the factory calibration with an enhancement factor $k=2$ (2-times standard deviation). The accuracy was calculated in accordance with EA-4/02 and with regard to GUM (Guide to the Expression of Uncertainty in Measurement).

2) The flow meter is calibrated at 7 bar (abs) 101.5 Psi. If the working pressure is different from 7 bar (101.5 Psi) you can compensate the error by setting the actual pressure with the configuration software.

Flow measuring range in dependence on operating pressure

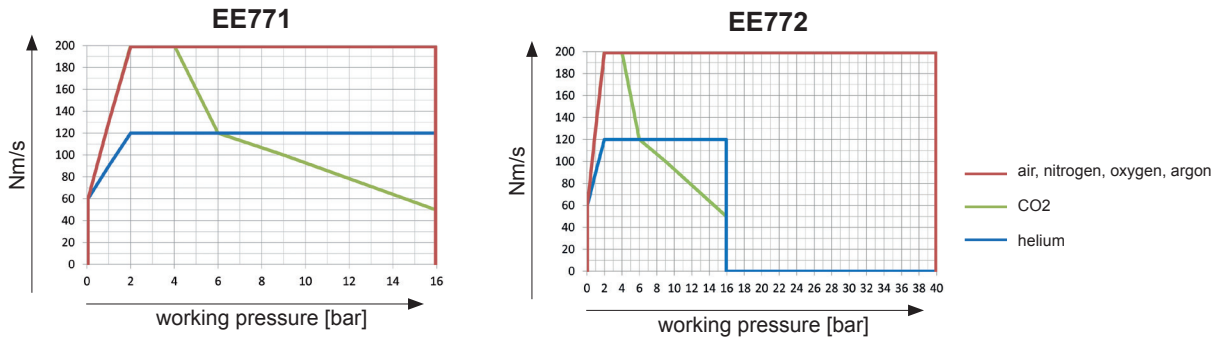

Formula for calculating the standardized volumetric flow:

$$\dot{V}_0 = v_0 \cdot id^2 \cdot \pi / 4 \cdot 3600$$

- \dot{V}_0 ... standardized volumetric flow [m³/h]
- v_0 ... standardized flow [m/s]
- id ... inner pipe diameter [m]
- π ... 3,1415

Connection Diagram

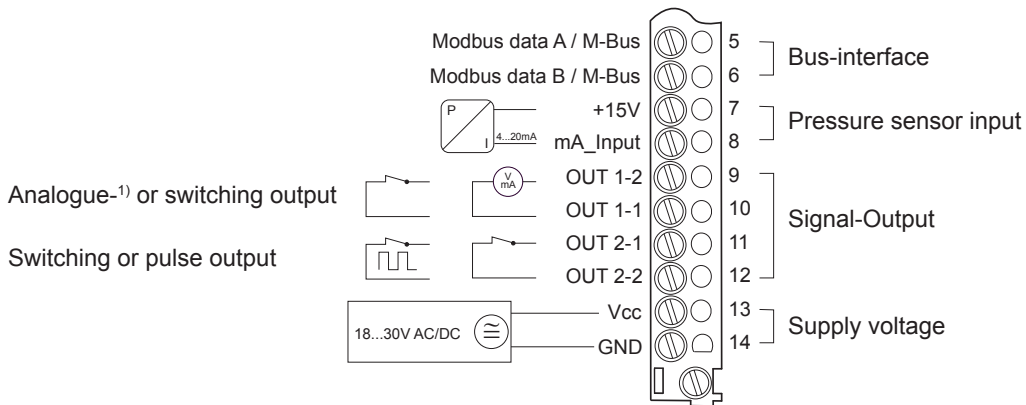

With analogue output OUT 1-1 is connected with GND.
 Switching and pulse output are potential-free.

Ordering Guide Accessories

- Dew point sensor
 - Sampling cell for dew point sensor
 - Quick coupling G1/2" for Multicontroller
 - Inlet and outlet pipe segment for mounting ball valve DN15^{*)}
 - Inlet and outlet pipe segment for mounting ball valve DN20^{*)}
 - Inlet and outlet pipe segment for mounting ball valve DN25^{*)}
 - Inlet and outlet pipe segment for mounting ball valve DN32^{*)}
 - Inlet and outlet pipe segment for mounting ball valve DN40^{*)}
 - Inlet and outlet pipe segment for mounting ball valve DN50^{*)}
- see datasheet EE371
 HA050102
 HA070202
 HA070215
 HA070220
 HA070225
 HA070232
 HA070240
 HA070250

^{*)} Inlet and outlet pipe segment is only available for mounting ball valve with BSP thread

Ordering Guide

The complete Flow meter consists of the Transmitter (pos. 1) and the mounting valve (pos. 2). Both have to be ordered together! The probe cable (pos. 3) is only necessary for model C.

Position 1 - Transmitter			EE771-	EE772-		
Hardware Configuration	Model	Compact ri-le Compact le-ri remote probe	A B C	A B C		
	Working range	low high	L1 H1	H1		
	Mounting valve for pipe diameter	DN15 (1/2") DN20 (3/4") DN25 (1") DN32 (1 1/4") DN40 (1 1/2") DN50 (2") DN65 (2 1/2") DN80 (3")	N015 N020 N025 N032 N040 N050	N040 N050 N065 N080		
	Display	without display with display	x D	x D		
	Mounting	ball valve MultiController MultiController with hot tap valve	K	M W		
	Electric connection	cable gland 1 plug for power supply and outputs	A Q	A Q		
	Bus-Interface	without bus-interface Modbus RTU M-Bus (Meter-Bus)	x 1 5	x 1 5		
	Software Configuration	Physical parameters of output 1	Temperature standardized volumetric flow mass flow standardized flow	T [°C] [°F] V ₀ [Nm ³ /h] [SCFM] m' [kg/h] v ₀ [Nm/s] [ft ³ /min]	B R S T	B R S T
Physical parameters of output 2		Temperature standardized volumetric flow mass flow standardized flow consumption ¹⁾	T [°C] [°F] V ₀ [Nm ³ /h] [SCFM] m' [kg/h] v ₀ [Nm/s] [ft ³ /min] Q ₀ [Nm ³] [ft ³]	B R S T I	B R S T I	
Output 1		0-5 V analogue output 0-10 V 0-20 mA 4-20 mA	2 3 5 6 S	2 3 5 6 S		
Output 2		switching output switching output pulse output ¹⁾	S I I	S I I		
Measured value unit		metric / SI non metric US / GB	M N	M N		
Medium		air nitrogen CO ₂ oxygen ²⁾ helium argon	A B C D F G	A B C D F G		
Position 2 - mounting valve			BSP-Thread	NPT-Thread		
DN15 - ball valve		HA075015	not available	DN40 - MultiController	HA071040	HA171040
DN20 - ball valve		HA075020	not available	DN50 - MultiController	HA071050	HA171050
DN25 - ball valve		HA075025	HA175025	DN65 - MultiController	HA071065	HA171065
DN32 - ball valve	HA075032	not available	DN80 - MultiController	HA071080	HA171080	
DN40 - ball valve	HA075040	HA175040	DN40 - MultiController with hot tap valve	HA072040	HA172040	
DN50 - ball valve	HA075050	HA175050	DN50 - MultiController with hot tap valve	HA072050	HA172050	
DN15 - ball valve for oxygen ²⁾	HA076015	not available	DN65 - MultiController with hot tap valve	HA072065	HA172065	
DN20 - ball valve for oxygen ²⁾	HA076020	HA176020	DN80 - MultiController with hot tap valve	HA072080	HA172080	
DN25 - ball valve for oxygen ²⁾	HA076025	HA176025				
Position 3 - Probe cable (only model C)						
cable length	2 m (6.56 ft) 5 m (16.4 ft) 10 m (32.8 ft)	HA010816 HA010817 HA010818				

1) consumption measuring is possible only with pulse output (output 2 = I)

2) Medium oxygen only for mounting valve DN15 up to DN25. The mounting valve and the sensor is oil and grease-free.

Order Example

Position 1 - Transmitter

EE771-AL1N025xKAx/RI6IMA

Model: Compact ri-le
Working range: low 0.9 ... 176 Nm³/h
Measuring pipe-diameter: DN25 (1")
Display: no
Mounting: ball valve
El. connection: cable gland
Bus-Interface: without bus-interface

Phys. parameter output 1:
Phys. parameter output 2:
Output 1:
Output 2:
Measured value unit:
Medium:

standardized volumetric flow
consumption
4-20mA
pulse output
metric SI
air

Position 2 - mounting valve

HA070025

DN25 - ball valve