

EE75

High-Precision Air / Gas Velocity Transmitter for Industrial Applications

The EE75 series air velocity transmitters were developed to obtain accurate measuring results over a wide range of velocities and temperatures.

A high-quality hot film sensor element based on cutting-edge thin film technology ensures maximum sensitivity, even at lowest mass flows. At the same time, the innovative probe design produces reliable measuring results at high flow velocities of up to 40m/s (8000ft/min).

The integrated temperature compensation minimises the temperature cross-sensitivity of the EE75 series which, combined with the robust mechanical design, allows it to be used at process temperatures between -40 to +120°C (-40 to 248°F).

In addition to air velocity and temperature values, the transmitter calculates the volumetric flow rate in m³/min or ft³/min. The cross section of the duct needs to be determined for this purpose and the volumetric flow rate can be displayed and directed to one of the analogue outputs.

The configuration software included in the scope of supply allows to choose the appropriate output parameter and freely scale the display range and signal level of the two analogue outputs. In addition user-friendly calibration of the air velocity and temperature and the adjustment of key parameters (e.g. response time of the velocity measurement, low flow cut-off points, etc.) are supported as well.

An optional illuminated display with two control buttons integrated in the cover is available. In addition, this enables changes of the configuration to be made directly on the unit.

The EE75 series has a robust metal housing to protect against possible damage in rough industrial environments. There are five different models, providing a comprehensive range of mounting options:

- **Model A** for wall mounting
- **Model B** for duct mounting
- **Model C** with remote probe
- **Model E** with remote probe, pressure-tight up to 10bar (145psi)

The EE75 series can be used to measure the velocity of other gasses as well, although a correction has to be applied to the unit at the factory.



Model A



Model B



Model C

Typical Applications

- monitoring incoming and outgoing air (energy management) in HVAC applications
- filter monitoring and laminar flow control in cleanrooms
- exhaust systems, exhaust hoods and glove boxes in the pharmaceutical, bio and semiconductor industries
- mass flow measurement during incineration processes
- monitoring and measurement of compressed air systems
- air conveying systems
- wind tunnels and climate simulators

Features

- high accuracy
- working range 0...40 m/s (0...8000ft/min) and -40...120°C (-40...248°F)
- measurement of air velocity and temperature
- calculation of volumetric flow rate
- low dependence on angle of inflow
- probe diameter 8mm (0.3")
- remote probe up to 10m (32.8ft)
- easy mounting and maintenance
- correction for pressure, humidity and media
- low flow cut-off
- pressure tight up to 10bar (145psi)
- SI and US units selectable

Technical Data

Measuring value

Air velocity

Working range	0... 2m/s (0...400ft/min)	
	0... 10m/s (0...2000ft/min)	
	0... 40m/s (0...8000ft/min)	
Accuracy ¹⁾ in air at 25°C (77°F) ²⁾ at 45% RH and 1013hPa	0.06... 2m/s (12...400ft/min)	± 0.03m/s / 6ft/min
	0.15...10m/s (30...2000ft/min)	± (0.10m/s / 20ft/min + 1 % of measuring value)
	0.2... 40m/s (40...8000ft/min)	± (0.20m/s / 40ft/min + 1 % of measuring value)
Uncertainty of factory calibration ¹⁾	± (1% of measuring value, min. 0.015m/s (3ft/min))	
Temperature dependence electronics	typ. -0.005 % of measuring value / °C	
Temperature dependence probe	± (0.1% of measuring value/°C)	
Dependence	of angle of inflow:	< 3% for $\alpha < 20^\circ$
	of direction of inflow:	< 3%
Response time τ_{90} ³⁾	< 1.5...40s (configurable)	

Temperature

Working range	probe:	-40...120°C (-40...248°F)
	probe cable:	-40...105°C (-40...221°F)
	electronic:	-40...60°C (-40...140°F)
	electronic with display:	-30...60°C (-22...140°F)
Accuracy at 20°C (68°F)	±0.5°C (±0.9°F)	
Temperature dependence electronics	typ. -0.01°C / °C	
Response time τ_{90} ³⁾	10s	

Outputs

output signals and display ranges are freely scaleable (see ranges below)		
voltage	0-10V (e.g. 0-5V, 1-5V etc.)	-1mA < I_L < 1mA
current (3-wire)	0-20mA (e.g. 4-20mA etc.)	$R_L < 350 \text{ Ohm}$
v-scaling	0...2 / 10 / 40m/s (0...400 / 2000 / 8000ft/min)	
T-scaling	-40...120°C (-40...248°F)	
Vol-scaling	0...10000m ³ /min (0...353147ft ³ /min)	

General

Supply voltage	24V DC/AC ± 20%		
Current consumption	max. 100mA; max. 160mA (with display)		
Working range humidity	0...99% RH - no condensation		
Connection	screw terminals max. 1.5mm ² (AWG 16)		
Electromagnetic compatibility	EN61326-1	EN61326-2-3	ICES-003 ClassB
	Industrial Environment		FCC Part15 ClassB
Pressure range	Model E and P pressure tight up to 10bar (145psi)		
Material	housing / protection class:	metal (AlSi3Cu) / IP65; Nema 4	
	measuring probe:	stainless steel	
	measuring head:	PBT (polybutylenterephthalat)	
System requirements for configuration software	Windows 2000 or Windows XP		
Interface	USB 1.1		



- 1) The accuracy statement includes the uncertainty of the factory calibration with an enhancement factor k=2 (2-times standard deviation).
The accuracy was calculated in accordance with EA-4/02 and with regard to GUM (Guide to the Expression of Uncertainty in Measurement).
- 2) Accuracy refers to measurement in air
- 3) Response time τ_{90} is measured from the beginning of a step change to the moment of reaching 90% of the step.

Configuration Software

An easy setup of the EE75 can be made via standard USB interface and the software included in the scope of supply.

The user can easily set the response time, correct for the gas (air) pressure, perform an one or two point adjustment and define the duct cross section for the volumetric flow rate.

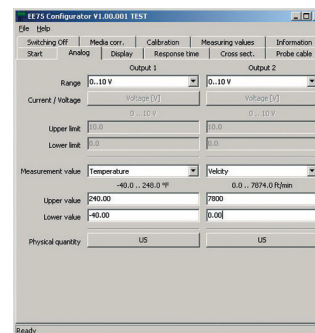

Angular Dependence

The innovative design of the probe head minimises the effect of the angle of inflow on the measuring result. The deviation of the measuring value remains < 3% up to an angle of inflow (α) of $\pm 20^\circ$ between the direction of inflow and the sensor element's longitudinal axis.

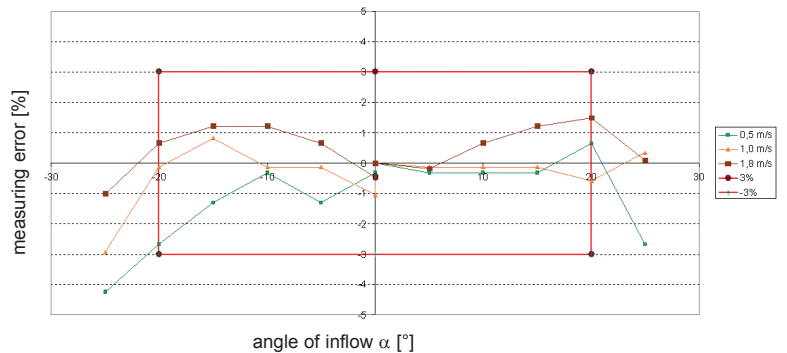
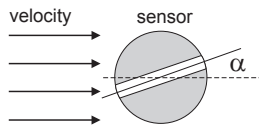

Low flow cut-off

Small temperature differences in shut-off pipes and ducts can cause minimal flows. Even these would be detected and measured by the EE75. The resulting fluctuations in the output signal can be suppressed by the low flow cut-off. Cut-off point and switching hysteresis can be specified using the configuration software.

Calculation of volumetric flow

The EE75 measures air velocity in m/s or ft/min. The configuration software can be used to enter the cross-section. This enables the transmitter to calculate the volumetric flow rate in m³/min or ft³/min. The data can be displayed and directed to one of the analogue outputs.

Connection versions

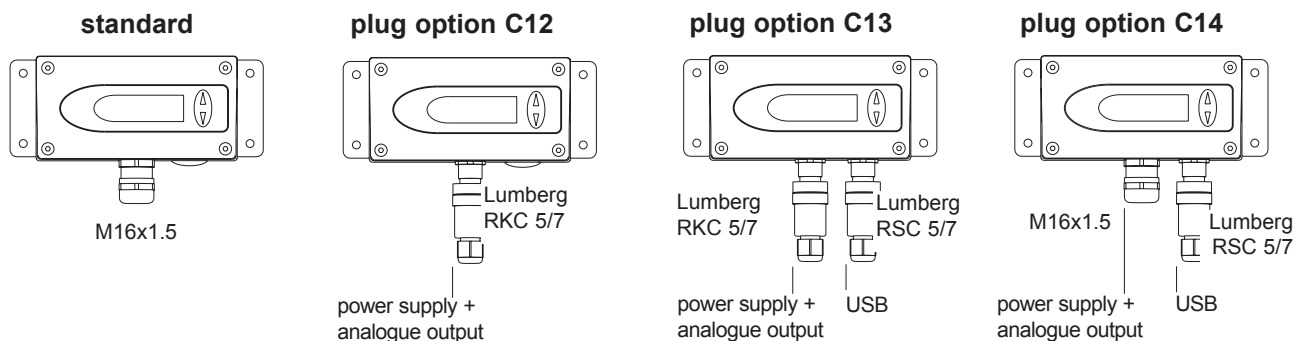

Connection Diagram

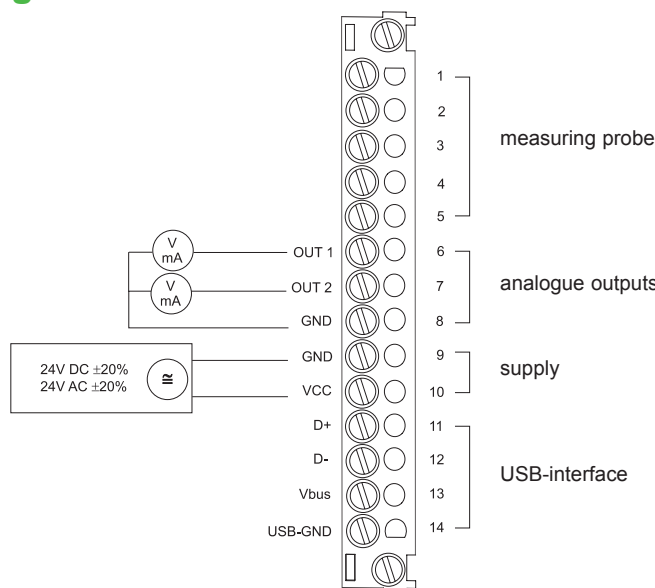

Dimensions in mm

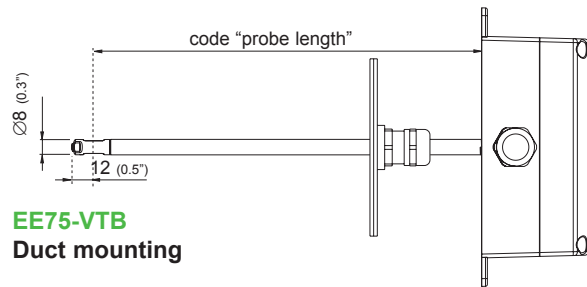
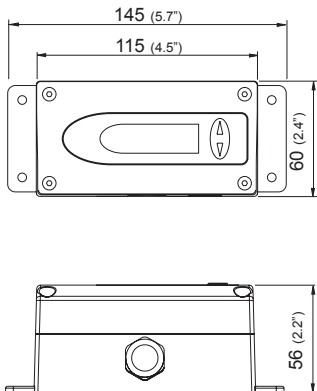

EE75-VTB
Duct mounting

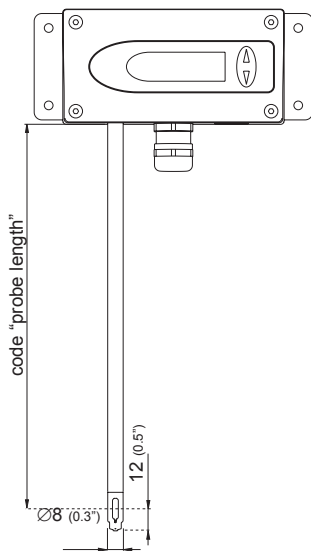

EE75-VTA
Wall mounting

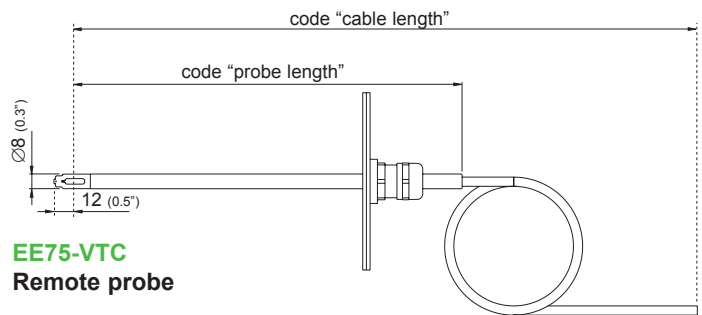

EE75-VTC
Remote probe

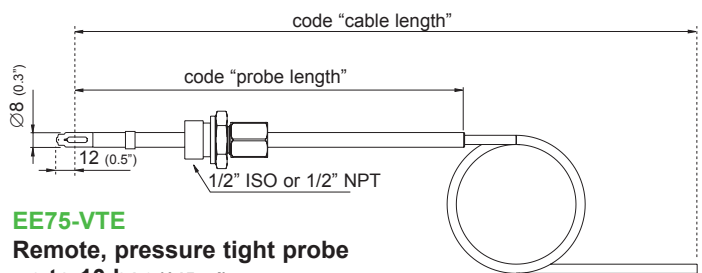

EE75-VTE
Remote, pressure tight probe
up to 10 bar (145psi)

Mounting flange (included in the scope of supply)

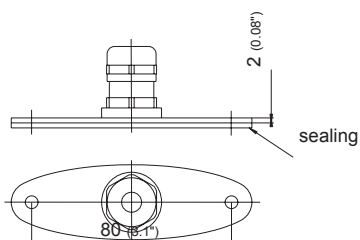

Ordering Guide

		EE75-VTA	EE75-VTB	EE75-VTC	EE75-VTE
Hardware Configuration					
Output	0...10V 4...20mA	3 6	3 6	3 6	3 6
Working range	0...2m/s 0...10m/s 0...40m/s	1 2 3	1 2 3	1 2 3	1 2 3
Probe length	200mm 400mm 600mm	5 6 7	5 6 7	5 6 7	5 6 7
Cable length	2m 5m 10m			K200 K500 K1000	K200 K500 K1000
Display	without display with display	D06	D06	D06	D06
Pressure tight feedthrough	1/2" ISO thread 1/2" NPT thread				HA03 HA07
Plug	cable glands 1 plug for power supply and outputs 2 plug for power supply / outputs and USB 1 plug for USB	C12 C13 C14	C12 C13 C14	C12 C13 C14	C12 C13 C14
Software Configuration					
Physical parameters	Temperature	T [°C]	(B)	output 1	Select according to Ordering Guide (B,N,O) Select according to Ordering Guide (B,N,O)
outputs	Velocity	v [m/s]	(N)	output 2	
	Volume ¹⁾	v [m³/min]	(O)		
Measured value units	metric / SI non metric / US				E01 E01 E01 E01
Scaling of v-output in m/s oder ft/min	0...0.5 (V01) 0...1 (V02) 0...1.5 (V03) 0...2 (V04) 0...5 (V05) 0...10 (V06) 0...15 (V07) 0...20 (V08) 0...25 (V09)	0...30 (V10) 0...35 (V11) 0...40 (V12) 0...100 (V13) 0...200 (V14) 0...300 (V15) 0...400 (V16) 0...1000 (V17)	0...2000 (V18) 0...3000 (V19) 0...4000 (V20) 0...5000 (V21) 0...6000 (V22) 0...7000 (V23) 0...7800 (V24) 0...8000 (V25)		Select according to Ordering Guide (Vxx)
Scaling of T-ouput in °C oder °F	-40...60 (T02) -10...50 (T03) 0...50 (T04) 0...100 (T05) 0...60 (T07) -30...70 (T08)	-30...120 (T09) -20...120 (T10) -10...70 (T11) -40...120 (T12) 20...120 (T15) -30...60 (T20)	0...80 (T21) -40...80 (T22) -20...80 (T24) -20...60 (T25) -30...50 (T45) -20...50 (T48)		Select according to Ordering Guide (Txx) Other T Scaling refer to data sheet „T-Scalings“
Measurement	Air Nitrogen N Carbon dioxide CO ₂				B B B B C C C C

1) Please declare the duct cross-section [m²] with your order.

Order Example

EE75-VTB325C12/BN-V05-T07

Model: duct mounting
 Output: 0...10V
 Working range: 0...10m/s (0...2000ft/min)
 Probe length: 200mm (7.9")
 Display: without
 Plug: 1 plug for power supply and outputs

Output 1: T
 Output 2: v
 Measured value units: metric / SI
 v-Scaling: 0...5m/s
 T-Scaling: 0...60°C
 Measurement media: air