

# OPERATING UNIT

## 160x104 with touch panel

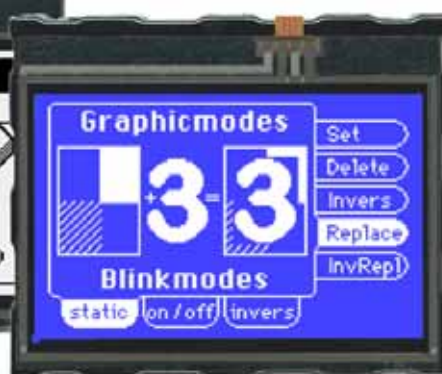

EA eDIP160W-7LWTP



EA eDIP160B-7LWTP



Dimension: 81.5x67.5x13.6mm

### TECHNICAL DATA

- \* LCD-GRAPHIC DISPLAY WITH A RANGE OF GRAPHIC FUNCTIONS
- \* 3 DIFFERENT INTERFACES ONBOARD: RS-232, I<sup>2</sup>C-BUS OR SPI-BUS
- \* 160x104 OR 104X160 DOT WITH LED BACKLIGHT
- \* WHITE LED-BACKLIGHT BLUE NEGATIVE OR BLACK&WHITE POSITIVE, FSTN-TECHNOLOGY
- \* 8 BUILT-IN FONTS
- \* FONT ZOOM FROM 2MM TO ABOUT 80MM, TURNABLE IN 90° STEPS
- \* POWER SUPPLY WIDE RANGE +3,3V / 190mA / 12mA ... +5V / 125mA / 20mA (WITH/ WITHOUT BACKLIGHT)
- \* POWER-DOWN-MODE 25 µA, WITH WAKEUP VIA TOUCH OR I<sup>2</sup>C
- \* POSITIONING ACCURATE TO THE PIXEL WITH ALL FUNCTIONS
- \* LINE, DOT, AREA, AND/OR/EXOR, BARGRAPH...
- \* CLIPBOARD FUNCTIONEN, PULL-DOWN MENÜ
- \* UPTO 256 PICTURES INTERNALLY STORED
- \* UPTO 256 MACROS PROGRAMMABLE (64kB EEPROM ONBOARD)
- \* MIXTEXT AND GRAPHIC, FLASHING ATTRIBUTE: ON/OFF/INVERT
- \* BACKLIGHT BRIGHTNESS PER SOFTWARE
- \* ANALOGUE TOUCH PANEL: VARIABLE GRID
- \* FREE DEFINABLE KEY AND SWITCH

### ORDERING CODES

160x104 DOTS, WHITE LED-BACKLIGHT, BLUE NEGATIVE  
AS ABOVE, BUT WITH TOUCH PANEL

**EA eDIP160B-7LW**  
**EA eDIP160B-7LWTP**

160x104 DOTS, WHITE LED-BACKLIGHT, POSITIVE MODE, FSTN  
AS ABOVE, BUT WITH TOUCH PANEL

**EA eDIP160W-7LW**  
**EA eDIP160W-7LWTP**

EVALUATION BOARD FOR USB (WIN2000/XP/VISTA/7)  
INTERFACE-EXPANSION FOR EA 9777-2USB

**EA 9777-2USB**  
**EA 9777-2PE**

STARTERKIT, (1x EA eDIP160B-7LWTP + 9777-2USB + 9777-2PE + CD)

**EA EVALeDIP160B**

STARTERKIT, (1x EA eDIP160W-7LWTP + 9777-2USB + 9777-2PE + CD)

**EA EVALeDIP160W**

SOCKET 1x20, 4.5mm HIGH (1 pcs.)

**EA B254-20**

MOUNTING BEZEL, BLACK ANODIZED ALUMINIUM

**EA 0FP161-7SW**

**ELECTRONIC  
ASSEMBLY**

making things easy

Documentation of revision				
Date	Type	Old	New	Reason / Description
October, 2010	0.1			preliminary Version
August, 2011	1.0			first release

## CONTENTS

GENERAL .....	3
RS-232 .....	4
RS-485, USB .....	5
SPI .....	6
I <sup>2</sup> C .....	7
IN- AND OUTPUTS .....	8
ROTATED MOUNTING .....	9
POWER-DOWN-MODE .....	9
SOFTWARE PROTOCOL .....	10 - 11
TERMINAL MODE, FILL PATTERN .....	12
COMMANDS/ FUNCTIONS INTABULAR FORMAT .....	13 - 17
TOUCHPANEL , KEY STYLE .....	16 - 17
RESPONSES OFTHE OPERATING PANEL .....	18
CHARACTER SETS .....	19 - 20
FLASH- AND GRAYSCALE MODE .....	21
MACRO PROGRAMMING .....	24 - 25
ELECTRICAL CHARACTERISTICS .....	26
MOUNTING BEZEL .....	27
DIMENSION .....	28

## GENERAL

The EA eDIP series of displays are the world's first displays with integrated intelligence. In addition to a variety of integrated fonts that can be used with pixel accuracy, they offer a whole range of sophisticated graphics functions.

The displays are ready for operation immediately with an operating voltage range of +3.3V..+5V. They are controlled via one of the 3 integrated interfaces: RS-232, SPI or I<sup>2</sup>C. The displays are "programmed" by means of high-level language-type graphics commands. There is no longer any need for the time-consuming programming of character sets and graphics routines. The ease of use of this display with its touch panel dramatically reduces development times.

## HARDWARE

The display is designed to work at an operating voltage range of +3.3V..+5V. Data transfer is either serial and asynchronous in RS-232 format or synchronous via the SPI or I<sup>2</sup>C specification. To improve data security, a simple protocol is used for all types of transfer.

## ANALOGUE TOUCH PANEL

All versions are also available with an integrated touch panel: You can make entries and menu or bar graph settings by touching the display. The labeling of the "keys" is flexible and can also be changed during runtime (different languages, icons). The drawing of the individual "keys" and the labeling is handled by the integrated software.

## LED ILLUMINATION, B- AND W-TYPES

All displays in blue-and-white (B) and black-and-white (W) are equipped with a modern, low power consumption LED backlight. Whereas the black&white can still be read even when the backlight is switched off completely, the blue-white display requires a minimum level of illumination to be legible. The backlight can be switched off with a software command and the brightness can be adjusted. We recommend the black&white version for use in direct sunlight. For all other applications, we recommend the high-contrast, blue-white version. Note that the white LED backlight is subject to aging. That means switching off or dimming backlight is a must for 24-hour-applications.

## SOFTWARE

This display is programmed by means of commands, such as draw a rectangle from (0,0) to (64,15). No additional software or drivers are required. Strings and images can be placed with pixel accuracy. Text and graphics can be combined at any time. Different character sets can be used at same time. Each character set and the images can be zoomed from 2 to 8 times and rotated in 90° steps. With the largest character set, the words and numbers displayed will fill the screen.

## ACCESSORIES

### Evaluation-Board (Programmer) for internal data flash memory

The display is shipped fully programmed and with all fonts. The additional Evaluation-Board is thus generally not required.

However, if the internal character sets have to be changed or extended, or if images or macros have to be stored internally, the Evaluation-Board EA 9777-2USB, which is available as an accessory, will burn the data/images you have created into the on-board EEPROM (64 kB) permanently.

The Evaluation-Board runs under Windows and is connected to the PC's USB interface. It is shipped with an interface cable and the installation software. The Evaluation-Board is equipped with several LEDs, pushbuttons and potentiometer to test all peripheral modes of the eDIP.

### Interface-Expansion for Evaluation-Board:

With the expansion EA 9777-2PE for the Evaluation-Board all interfaces of the display are made available with the help from small adapter boards: RS-232, RS-485, SPI, I<sup>2</sup>C, RS-232 (CMOS level). Further information you will find in the datasheet of the Evaluation-Board.

## RS-232INTERFACE

If the display is wired as shown below, the RS-232 interface is selected. The pin assignment is specified in the table on the right. The RxD and TxD lines lead CMOS level (VDD) to a microcontroller, for example, for direct connection.

If "genuine" RS-232 levels are required (e.g. for connection to a PC), an external level converter (e.g. MAX232) is required.

Pinout eDIP160-7: RS-232/RS-485 mode							
Pin	Symbol	In/Out	Function	Pin	Symbol	In/Out	Function
1	GND		Ground Potential for logic (0V)	21	GND		Ground (0V)
2	VDD		Power supply for logic (+3,3V..5V)	22	VDD		Power supply (+3,3..5V)
3	NC		do not connect	23	NC		do not connect
4	NC		do not connect	24	NC		do not connect
5	RESET	In	L: Reset	25	IN8 / OUT1		8 digital inputs (internal 20k..50k pullup)  alternativ up to 8 digital outputs maximum current: IOL = IOH = 10mA
6	BAUD0	In	Baud Rate 0	26	IN7 / OUT2		
7	BAUD1	In	Baud Rate 1	27	IN6 / OUT3		
8	BAUD2	In	Baud Rate 2	28	IN5 / OUT4		
9	ADR0	In	Address 0 for RS-485	29	IN4 / OUT5		
10	RxD	In	Receive Data	30	IN3 / OUT6		
11	TxD	Out	Transmit Data	31	IN2 / OUT7		
12	EN485	Out	Transmit Enable for RS-485 driver	32	IN1 / OUT8		
13	WUP	In	L: (Power-On) disable Power-On-Macro L: Wakeup from Powerdownmode	33	NC		do not connect
14	ADR1	In	Address 1 for RS-485	34	NC		
15	ADR2	In	Address 2 for RS-485	35	NC		
16	BUZZ	Out	H: Buzzer output (L: Buzzer off)	36	NC		
17	DPROT	In	L: Disable Smallprotokoll do not connect for normal operation	37	NC		
18	PWR	Out	L: Normal Operation H: Powerdownmode	38	NC		
19	NC		do not connect	39	NC		
20	TEST SBUF	IN Out	open-drain with internal pullup 20k..50k IN (Power-On) L: Testmode OUT L: data in sendbuffer	40	NC		

## BAUD RATES

The baud rate is set by means of pins 6, 7 and 8 (baud 0 to 2). The data format is set permanently to 8 data bits, 1 stop bit, no parity.

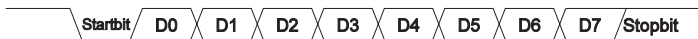

RTS/CTS handshake lines are not required. The required control is taken over by the integrated software protocol (see pages 10 and 11).

Baud rates			
Baud0	Baud1	Baud2	Data format 8,N,1
0	0	0	1200
1	0	0	2400
0	1	0	4800
1	1	0	9600
0	0	1	19200
1	0	1	38400
0	1	1	57600
1	1	1	115200

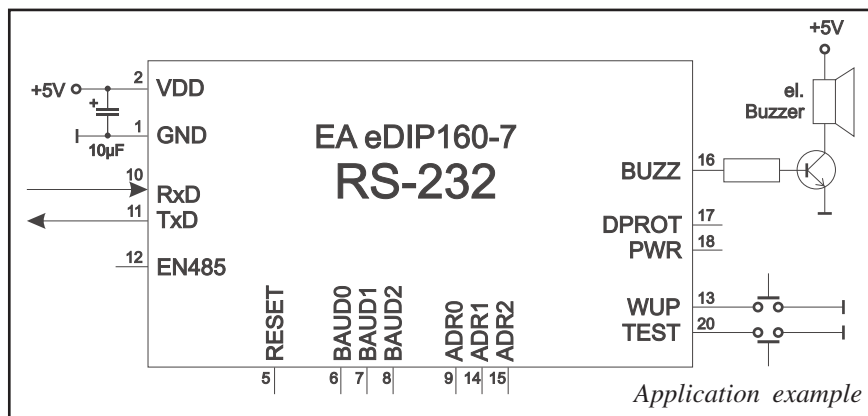

### Note:

The pins BAUD 0 to 2, ADR 0 to 2, DPOM, DPROT and TEST/SBUF have an internal pullup, which is why only the LO level (0=GND) is to be actively applied. These pins must be left open for a hi level. For RS232 operation (without addressing) the pins ADR 0 to ADR 2 must be left open. On pin 20 (SBUF) the display indicates with a low level that data is ready to be retrieved from the internal send buffer. The line can be connected to an interrupt input of the host system, for example.

### APPLICATION EXAMPLE „REAL“ RS-232 INTERFACE

The eDIP fits for direct connection to a RS-232 interface with CMOS level (VDD).

If you have an interface with  $\pm 12V$  level, an external levelshifter is needed.

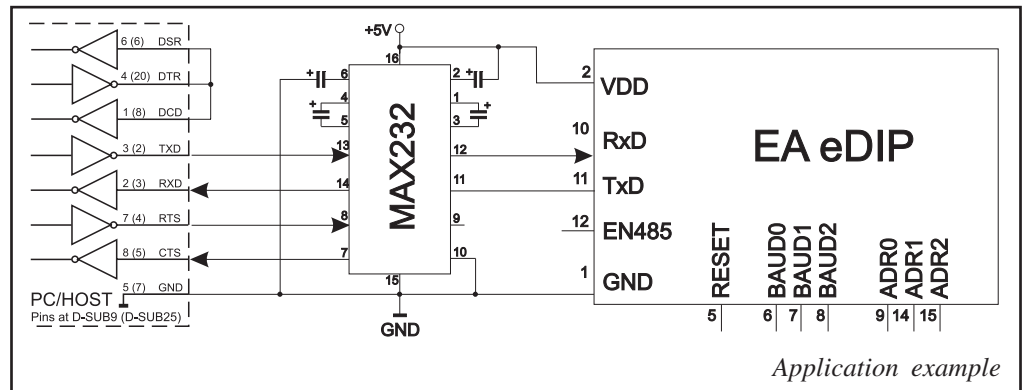

### APPLICATION EXAMPLE: RS-485 INTERFACE

With an external converter (e.g. SN75176), the EA eDIP can be connected to a 2-wire RS-485 bus. Large distances of up to 1200 m can thus be implemented (remote display). Several EA eDIP displays can be operated on a single RS-485 bus by setting addresses.

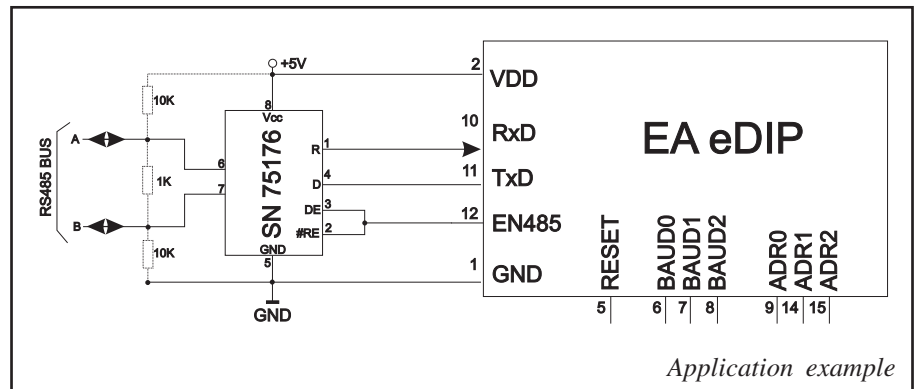

Addressing:

- Up to eight hardware addresses (0 to 7) can be set by means of Pins ADR0..ADR2
- The eDIP with the address 7 is selected and ready to receive after power-on.
- The eDIPS with the addresses 0 to 6 are deselected after power-on
- Up to 246 further software addresses can be set by means of the '#KA adr' command in the power-on macro (set eDIP externally to address 0)

### APPLICATION EXAMPLE: USB INTERFACE

With an external converter (e.g. FT232R from FTDI) the eDIP can be connected to an USB-Bus. Virtual-COM-Port drivers are available for different Systems on the FTDI Homepage:

<http://www.ftdichip.com/drivers/vcp.htm>.

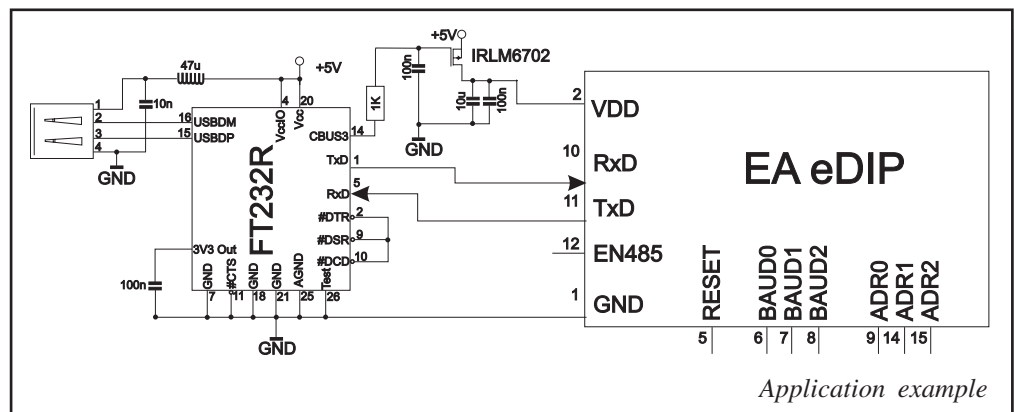



## SPI INTERFACE

If the display is wired as shown below, SPI mode is activated. The data is then transferred via the serial, synchronous SPI interface. The transfer parameter will be set via the pins DORD, CPOL and CPHA.

Pinout eDIP160-7: SPI mode							
Pin	Symbol	In/Out	Function	Pin	Symbol	In/Out	Function
1	GND		Ground Potential for logic (0V)	21	GND		Ground (0V)
2	VDD		Power supply for logic (+3,3V..5V)	22	VDD		Power supply (+3,3..5V)
3	NC		do not connect	23	NC		do not connect
4	NC		do not connect	24	NC		do not connect
5	RESET	In	L: Reset	25	IN8 / OUT1		8 digital inputs (internal 20k..50k pullup)  alternativ up to 8 digital outputs maximum current: IOL = IOH = 10mA
6	SS	In	Slave Select	26	IN7 / OUT2		
7	MOSI	In	Serial In	27	IN6 / OUT3		
8	MISO	Out	Serial Out	28	IN5 / OUT4		
9	CLK	In	Shift Clock	29	IN4 / OUT5		
10	DORD	In	Data Order (0=MSB first; 1=LSB first)	30	IN3 / OUT6		
11	SPIMOD	In	connect to GND for SPI interface	31	IN2 / OUT7		
12	NC		do not connect	32	IN1 / OUT8		
13	WUP	In	L: (Power-On) disable Power-On-Macro L: Wakeup from Powerdownmode	33	NC		do not connect
14	CPOL	In	Clock Polarity (0=LO 1=HI when idle)	34	NC		do not connect
15	CPHA	In	Clock Phase sample 0=1st;1=2nd edge	35	NC		do not connect
16	BUZZ	Out	H: Buzzer output (L: Buzzer off)	36	NC		do not connect
17	DPROT	In	L: Disable Smallprotokoll do not connect for normal operation	37	NC		do not connect
18	PWR	Out	L: Normal Operation H: Powerdownmode	38	NC		do not connect
19	NC		do not connect	39	NC		do not connect
20	TEST SBUF	IN Out	open-drain with internal pullup 20k..50k IN (Power-On) L: Testmode OUT L: data in sendbuffer	40	NC		do not connect

**Note:**

The pins DORD, CPOL, CPHA, DPOM, DPROT and TEST/SBUF have an internal pullup, which is why only the LO level (0=GND) is to be actively applied. These pins must be left open for a hi level. On pin 20 (SBUF) the display indicates with a low level that data is ready to be retrieved from the internal send buffer. The line can be connected to an interrupt input of the host system, for example.

## DATATRANSFER SPI

**Write operation:** a clock rate up to 100 kHz is allowed without any stop. Together with a pause of 100 μs between every data byte a clock rate up to 3 MHz can be reached.

**Read operation:** to read data (e.g. the „ACK“ byte) a dummy byte (e.g. 0xFF) need to be sent.

Note that the EA eDIP for internal operation does need a short time before providing the data; therefore a short pause of min. 6μs (no activity of CLK line) is needed for each byte.

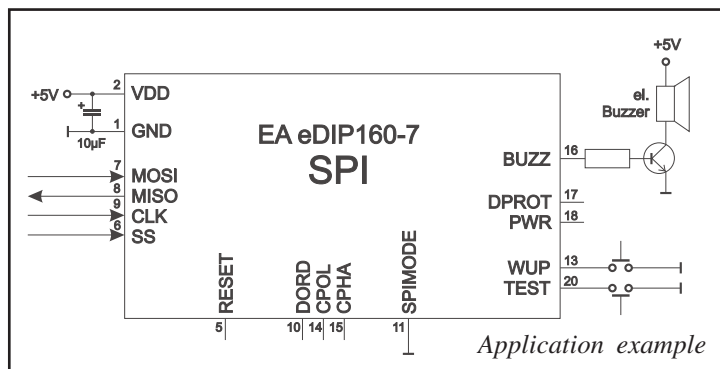
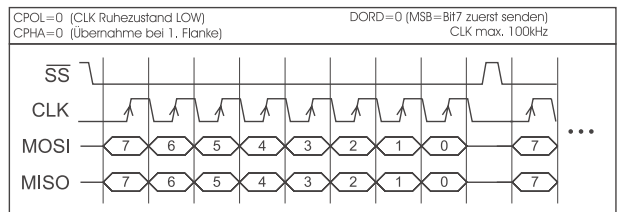
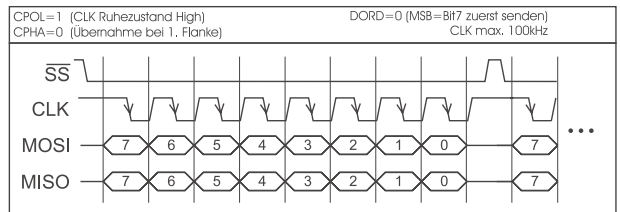
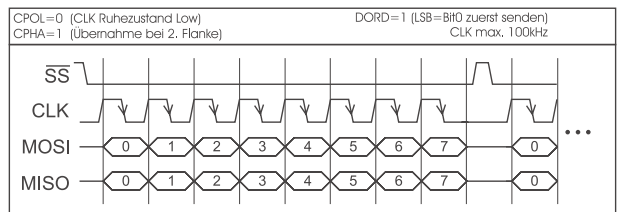
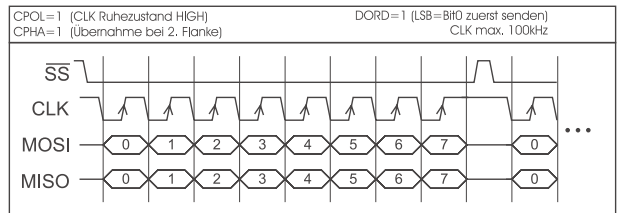

## I<sup>2</sup>C-BUS INTERFACE

If the display is wired as shown below, it can be operated directly on an I<sup>2</sup>C bus.

8 different base addresses and 8 slave addresses can be selected on the display.

Data transfer is possible at up to 100 kHz. However, if pauses of at least 100 μs are maintained between the individual bytes during transfer, a byte can be transferred at up to 400 kHz.

Pinout eDIP160-7: I <sup>2</sup> C mode							
Pin	Symbol	In/Out	Function	Pin	Symbol	In/Out	Function
1	GND		Ground Potential for logic (0V)	21	GND		Ground (0V)
2	VDD		Power supply for logic (+5V)	22	VDD		Power supply (+3,3..5V)
3	NC		do not connect	23	NC		do not connect  8 digital inputs (internal 20k..50k pullup)  alternativ up to 8 digital outputs maximum current: IOL = IOH = 10mA
4	NC		do not connect	24	NC		
5	RESET	In	L: Reset	25	IN8 / OUT1		
6	BA0	In	Basic Address 0	26	IN7 / OUT2		
7	BA1	In	Basic Address 1	27	IN6 / OUT3		
8	SA0	In	Slave Address 0	28	IN5 / OUT4		
9	SA1	In	Slave Address 1	29	IN4 / OUT5		
10	SA2	In	Slave Address 2	30	IN3 / OUT6		
11	BA2	In	Basic Address 2	31	IN2 / OUT7		do not connect
12	I <sup>2</sup> CMOD	In	connect to GND for I <sup>2</sup> C interface	32	IN1 / OUT8		
13	WUP	In	L: (Power-On) disable Power-On-Macro L: Wakeup from Powerdownmode	33	NC		
14	SDA	Bidir.	Serial Data Line	34	NC		
15	SCL	In	Serial Clock Line	35	NC		
16	BUZZ	Out	H: Buzzer output (L: Buzzer off)	36	NC		
17	DPROT	In	L: Disable Smallprotokoll do not connect for normal operation	37	NC		
18	PWR	Out	L: Normal Operation H: Powerdownmode	38	NC		
19	NC		do not connect	39	NC		
20	TEST SBUF	IN Out	open-drain with internal pullup 20k..50k IN (Power-On) L: Testmode OUT L: data in sendbuffer	40	NC		

### Note:

The pins DORD, CPOL, CPHA, DPOM, DPROT and TEST/SBUF have an internal pullup, which is why only the LO level (0=GND) is to be actively applied. These pins must be left open for a hi level.

On pin 20 (SBUF) the display indicates with a low level that data is ready to be retrieved from the internal send buffer. The line can be connected to an interrupt input of the host system, for example..

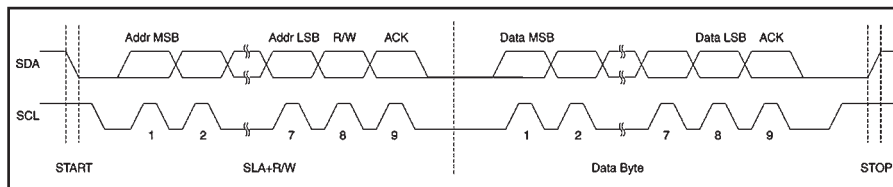

I <sup>2</sup> C - Address											
Pin 11,7,6			Base address	I <sup>2</sup> C address							
BA2	BA1	BA0	address	D7	D6	D5	D4	D3	D2	D1	D0
L	L	L	\$10	0	0	0	1	S A 2	S A 1	S A 0	R W
L	L	H	\$20	0	0	1	0				
L	H	L	\$30	0	0	1	1	S A 2	S A 1	S A 0	R W
L	H	H	\$40	0	1	0	0				
H	L	L	\$70	0	1	1	1	S A 2	S A 1	S A 0	R W
H	L	H	\$90	1	0	0	1				
H	H	L	\$B0	1	0	1	1	S A 2	S A 1	S A 0	R W
H	H	H	\$D0	1	1	1	1				

all pins open: Write \$DE  
Read \$DF

## DATATRANSFER I<sup>2</sup>C INTERFACE

principle I<sup>2</sup>C-bus transfer:

- I<sup>2</sup>C-Start
- Master-Transmit: EA eDIP-I<sup>2</sup>C-address (e.g. \$DE), send smallprotocol package (data)
- I<sup>2</sup>C-Stop
- I<sup>2</sup>C-Start
- Master-Read: EA eDIP-I<sup>2</sup>C-Address (e.g. \$DF), read ACK-byte and opt. smallprotocoll package (data)
- I<sup>2</sup>C-Stop

Read operation: for internal operation the EA eDIP does need a short time before providing the data; therefore a short pause of min. 6μs is needed for each byte (no activity of SCL line).

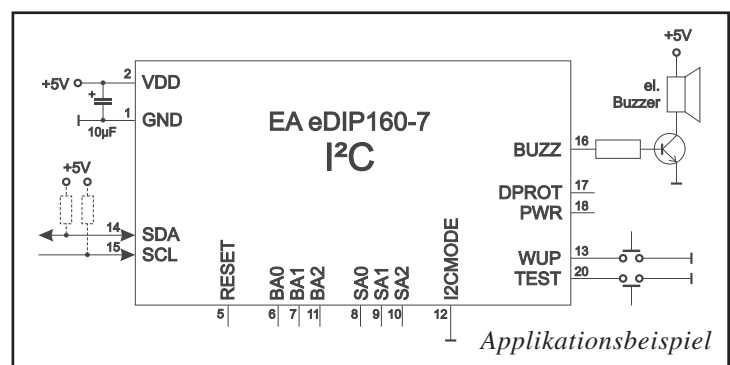

## IN- AND OUTPUTS

The eDIP160-7 has 8 digital in- or outputs (CMOS level, grounded). They can be redefined freely.

### Inputs

As status on delivery, all ports are defined as inputs. Each input provides an internal 20..50 kΩ pull-up resistor, so it is possible to connect a key or switch directly between input and GND. The inputs can be queried and evaluated directly via the serial interface („ESC Y R“).

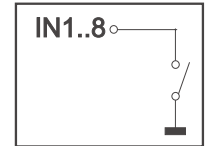

In addition to that every port change may start an individual port - or bit- macro (see p. 24). The command "ESC Y A 1" activates automatic port query. Every alteration of inputs firstly calls bit macros and afterwards port macros. If there is no defined macro, the new status is transferred into the send buffer (refer to p. 18).

**Note:** The logic circuitry is designed for slow operations; in other words, more than 3 changes per second cannot be easily executed.

### Outputs

The command "ESC Y M number" redefines one or several inputs as outputs. In this case the more significant inputs are used as outputs.

'ESC Y M 3' switches IN8, IN7 and IN6 as outputs OUT1, OUT2 and OUT3 for example.

Each line can be controlled individually using the „ESC Y W“ command. A maximum current of 10mA can be switched per line. This give the opportunity to drive a low power LED in direct way. To source higher current please use an external transistor.

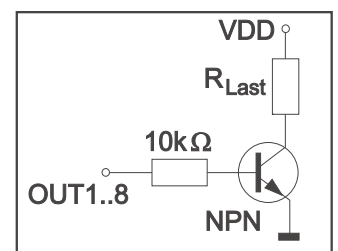
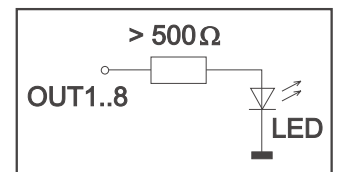

## EXTENDED OUTPUTS

It is possible to connect 1 to 32 chips like 74HC4094 to the eDIP (OUT1...OUT3), this is why it is attainable to have 8 to 256 additional outputs. The command "ESC Y E n1 n2 n3" (see p. 16) provides a comfortable way to control the outputs.

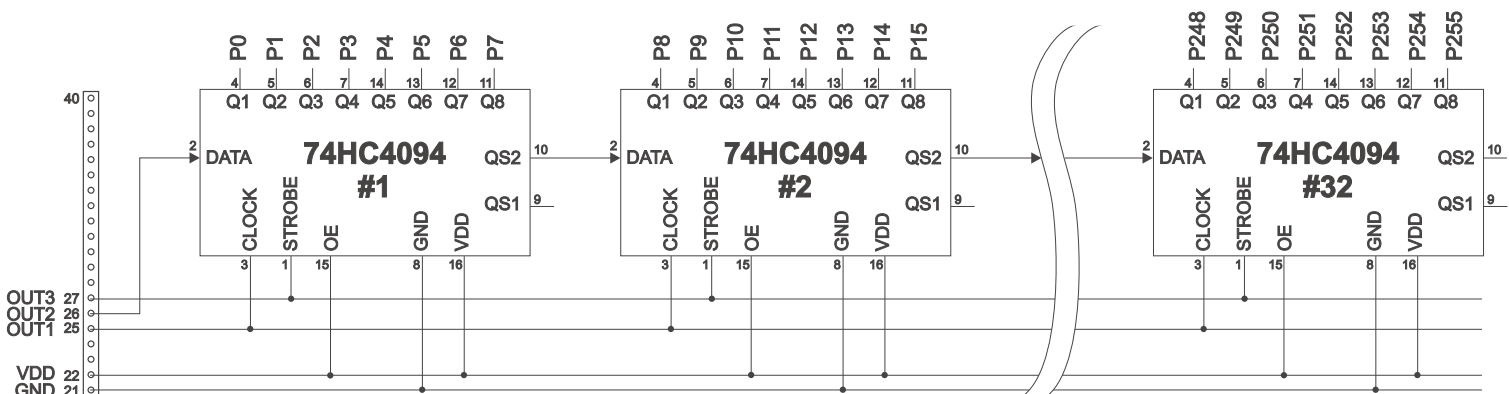



## TOPVIEW AND TWISTED MOUNTING

The preferred view of the eDIP160 is bottom view, (6 o'clock).

The eDIP can be mounted turned around 180° to gain a top view display (12 o'clock). To set the viewing direction you have to run (e.g. in PowerOnMacro) the command 'ESC DO 2' (refer to p. 13). In addition it is possible to mount the display turned with 90° or 270° to gain a portrait mode display with 104x160 pixels.

0°: 'ESC DO 0'



90°: 'ESC DO 1'



180°: 'ESC DO 2'



270°: 'ESC DO 3'



## POWER DOWN MODE

To save energy (battery operation), you can activate one of three power-down modes by means of the command 'ESC PD n1' (see page 15 below).

Mode 0 (25µA): The LED illumination is switched off, and the contents of the display become invisible although they are still there. In power-down mode including suppressor diodes, the eDIP160 requires up to 1000 µA (delivery state). The suppressor diodes can be deactivated by removing the two 0Ω resistors. Then powerdown current of typically 25 µA is reached. They are labeled with  $R_{pd}$ .  
**Important:** When deactivating the suppressor diodes, it is essential that the polarity of the display is correct all the time: GND, VDD (pin 1 + 2). Even very brief polarity reversal or overvoltage can damage the display immediately and irreparably.

Mode 1 (1mA): The LED illumination is switched off, the contents of the display stay visible. Current consumption is reducing to 1mA. This power down mode is mainly usable with the versions EA eDIP160W with positive display, because they are readable without backlight.

Mode 2 (2mA): The LED illumination stays on and the display content is readable. The current consumption reduces to 2-3mA plus adjusted LED current. Therefore you can use the eDIP in dark surroundings and dimmed illumination under e.g. 10mA.

The eDIP160 can be woken up from power down mode with a low level on pin 13 (WUP), or the addressing via I<sup>2</sup>C.

In addition the eDIP160 can be woken up by using the touchpanel (independent from position). After wake up, special WakeUpMacros can be used (refer to p. 24).

## DATATRANSFER PROTOCOL(SMALL PROTOCOL)

The protocol has an identical structure for all 3 interface types: RS-232, SPI and I<sup>2</sup>C. Each data transfer is embedded in a fixed frame with a checksum (protocol package). The EA eDIP160-7 acknowledges this package with the character <ACK> (= \$06) on successful receipt or <NAK> (= \$15) in the event of an incorrect checksum or receive buffer overflow. In the case of <NAK>, the entire package is rejected and must be sent again. Receiving the <ACK> byte means only that the protocol package is ok, there is no syntax check for the command.

**Note:** It is necessary to read the <ACK> byte in any case. If the host computer does not receive an acknowledgment, at least one byte is lost. In this case, the set timeout has to elapse before the package is sent again. The raw data volume per package is limited to 255 bytes (len <=255). Commands longer than 255 bytes (e.g. Load image ESC UL...) must be split up between a number of packages. All data in the packages are compiled again after being correctly received by the EA eDIP.

## DEACTIVATING THE SMALL PROTOCOL

For tests the protocol can be switched off with an L-level at pin 17 = DPROT. In normal operation, however, you are urgently advised to activate the protocol. If you do not, any overflow of the receive buffer will not be detected.

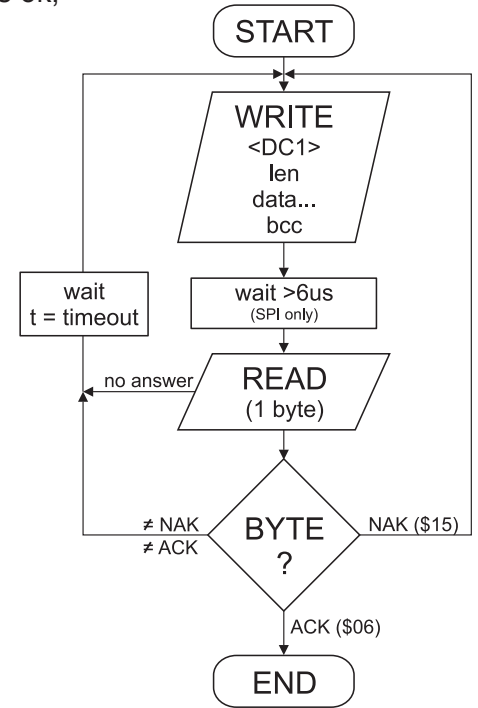

## BUILDING THE SMALL PROTOCOL PACKAGES

### Command/data to the display

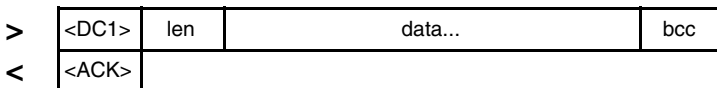

<DC1> = 17(dez.) = \$11

<ACK> = 6(dez.) = \$06

len = count of user data (without <DC1>, without checksum bcc)

bcc = 1 byte = sum of all bytes incl. <DC1> and len, modulo 256

Clear display and draw a line from 0,0 to 159,103

<DC1>	len	ESC D L ESC G D 0 0 159 103	bcc	>
\$11	\$0A	\$1B \$44 \$4C \$1B \$47 \$44 \$00 \$00 \$9F \$67 \$72		
<	<ACK>			
			\$06	

Example fo a complete datapackage

The user data is transferred framed by <DC1>, the number of bytes (len) and the checksum (bcc). The display responds with <ACK>.

```

void sendData(unsigned char *buf, unsigned char len)
{
    unsigned char i, bcc;

    SendByte(0x11); // Send DC1
    bcc = 0x11;

    SendByte(len); // Send data length
    bcc = bcc + len;

    for(i=0; i < len; i++) // Send buf
    {
        SendByte(buf[i]);
        bcc = bcc + buf[i];
    }

    SendByte(bcc); // Send checksum
}
  
```

C-example to send a datapcket

### Request for content of send buffer

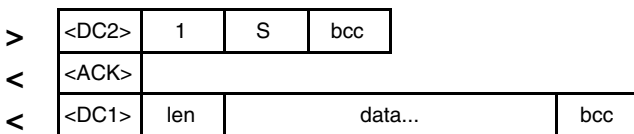

<DC2> = 18(dez.) = \$12    1 = 1(dez.) = \$01    S = 83(dez.) = \$53

<ACK> = 6(dez.) = \$06

len = count of user data (without <DC1>, without checksum bcc)

bcc = 1 byte = sum of all bytes incl. <DC1> and len, modulo 256

The command sequence <DC2>, 1, S, bcc empties the display's send buffer. The display replies with the acknowledgement <ACK> and begins to send all the collected data such as touch keystrokes.

**Request for buffer information**

>	<DC2>	1	I	bcc	
<	<ACK>				
<	<DC2>	2	send buffer bytes ready	receive buffer bytes free	bcc

<DC2> = 18(dez.) = \$12    I = 1(dez.) = \$01    I = 73(dez.) = \$49  
 <ACK> = 6(dez.) = \$06  
 send buffer bytes ready = count of bytes stored in send buffer  
 receive buffer bytes free = count of bytes for free receive buffer  
 bcc = 1 byte = sum of all bytes incl. <DC2>, modulo 256

This command queries whether user data is ready to be picked up and how full the display's receive buffer is.

**Protocol settings**

>	<DC2>	3	D	packet size for send buffer	timeout	bcc
<	<ACK>					

<DC2> = 18(dec.) = \$12    3 = 3(dez.) = \$03    D = 68(dez.) = \$44  
 packet size for send buffer = 1..128 (standard: 128)  
 timeout = 1..255 in 1/100 seconds (standard: 200 = 2 seconds)  
 bcc = 1 byte = sum of all bytes incl. <DC2>, modulo 256  
 <ACK> = 6(dec.) = \$06

This is how the maximum package size that can be sent by the display can be limited. The default setting is a package size with up to 128 bytes of user data. The timeout can be set in increments of 1/100 seconds. The timeout is activated when individual bytes get lost. The entire package then has to be sent again.

**Request for protocol settings**

>	<DC2>	1	P	bcc		
<	<ACK>					
<	<DC2>	3	max. packet size	akt. send packet size	akt. timeout	bcc

<DC2> = 18(dez.) = \$12    I = 1(dez.) = \$01    P = 80(dez.) = \$50  
 <ACK> = 6(dez.) = \$06  
 max. packet size = count of maximum user data for 1 package (eDIP160-7 = 255)  
 akt. send packet size = current package size for send  
 akt. timeout = current timeout in 1/100 seconds  
 bcc = 1 byte = sum of all bytes incl. <DC2>, modulo 256

This command is used to query protocol settings.

**Repeat the last package**

>	<DC2>	1	R	bcc
<	<ACK>			
<	<DC1>	len	data...	bcc

<DC2> = 18(dez.) = \$12    I = 1(dez.) = \$01    R = 82(dez.) = \$52  
 <ACK> = 6(dez.) = \$06  
 <DC1> = 17(dez.) = \$11  
 len = count of user data in byte (without checksum, without <DC1> or <DC2>)  
 bcc = 1 byte = sum of all bytes incl. <DC2> and len, modulo 256

If the most recently requested package contains an incorrect checksum, the entire package can be requested again. The reply can then be the contents of the send buffer (<DC1>) or the buffer/protocol information (<DC2>).

**Addressing (only for RS232/RS485)**

>	<DC2>	3	A	select or deselect	adr	bcc
<	<ACK>					

<DC2> = 18(dez.) = \$12    3 = 3(dez.) = \$03    A = 65(dez.) = \$41  
 select or deselect: 'S' = \$53 or 'D' = \$44  
 adr = 0..255  
 bcc = 1 byte = sum of all bytes incl. <DC2> and adr, modulo 256  
 <ACK> = 6(dec.) = \$06

This command can be used to select or deselect the eDIP with the address adr.

## TERMINAL MODE

When you switch the unit on, the cursor flashes in the first line, indicating that the display is ready for operation. All the incoming characters are displayed in ASCII format on the terminal (exception: CR,LF,FF,ESC,'#'). The prerequisite for this is a working protocol frame (pages 10 and 11) or a deactivated protocol.

Line breaks are automatic or can be executed by means of the 'LF' character. If the last line is full, the contents of the terminal scroll upward. The 'FF' character (page feed) deletes the terminal. The character '#' is used as an escape character and thus cannot be displayed directly on the terminal. If the character '#' is to be output on the terminal, it must be transmitted twice: '##'.

The terminal has its own level for displaying and is thus entirely independent of the graphic outputs.

If the graphics screen is deleted with 'ESC DL', for example, that does not affect the contents of the terminal window. The terminal font is fixed in the ROM and can also be used for graphic outputs 'ESC Z...' (set FONT nr=0).

	\$0 (0)	\$1 (1)	\$2 (2)	\$3 (3)	\$4 (4)	\$5 (5)	\$6 (6)	\$7 (7)	\$8 (8)	\$9 (9)	\$A (10)	\$B (11)	\$C (12)	\$D (13)	\$E (14)	\$F (15)
\$00 (dez: 0)	0	1	2	3	4	5	6	7	8	9	:	;	<	=	>	?
\$10 (dez: 16)	!	"	#	\$	%	&	'	(	)	*	+	,	-	.	/	
\$20 (dez: 32)		!	"	#	\$	%	&	'	(	)	*	+	,	-	.	/
\$30 (dez: 48)	0	1	2	3	4	5	6	7	8	9	:	;	<	=	>	?
\$40 (dez: 64)	A	B	C	D	E	F	G	H	I	J	K	L	M	N	O	
\$50 (dez: 80)	P	Q	R	S	T	U	V	W	X	Y	Z	[	\	]	^	_
\$60 (dez: 96)	a	b	c	d	e	f	g	h	i	j	k	l	m	n	o	
\$70 (dez: 112)	p	q	r	s	t	u	v	w	x	y	z	{		}	~	Δ
\$80 (dez: 128)	ü	é	ä	ä	ä	ç	è	è	è	ï	ï	ï	ä	ä		
\$90 (dez: 144)	é	æ	œ	ö	ö	ö	ü	ü	ö	ü	ç	é	ÿ	ß	f	
\$A0 (dez: 160)	á	í	ó	ú	ñ	ñ	á	ó	ç	í	í	¼	¾	í	«	»
\$B0 (dez: 176)	:	:	:	:	:	:	:	:	:	:	:	:	:	:	:	:
\$C0 (dez: 192)	L	T	T	T	T	T	T	T	T	T	T	T	T	T	T	T
\$D0 (dez: 208)	U	T	T	T	T	T	T	T	T	T	T	T	T	T	T	T
\$E0 (dez: 224)	α	β	Γ	π	Σ	σ	μ	τ	θ	θ	θ	φ	φ	φ	ε	π
\$F0 (dez: 240)	≡	±	≥	≤	ρ	ρ	÷	≈	*	*	*	.	√	n	z	3

Terminal-Font (Font 0): 8x8 monospaced

## FILL PATTERN

A pattern type can be set as a parameter with various commands. In this way, for example, rectangular areas and bar graphs can be filled with different patterns. There are 16 internal fill patterns available.

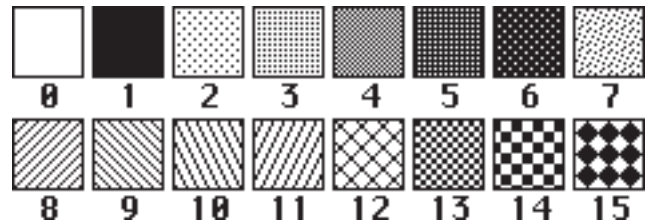

## USING THE SERIAL INTERFACE

The operating unit can be programmed by means of various integrated commands. Each command begins with ESCAPE followed by one or two command letters and then parameters. There are two ways to transmit commands:

### 1. ASCII mode

- The ESC character corresponds to the character '#' (hex: \$23, dec: 35).
- The command letters follow directly after the '#' character.
- The parameters are transmitted as plain text (several ASCII characters) followed by a separating character (such as a comma ','), also after the last parameter e.g.: #GD0,0,159,103,
- Strings (text) are written directly without quotation marks and concluded with CR (hex: \$0D) or LF (hex: \$0A).

### 2. Binary mode

- The escape character corresponds to the character ESC (hex: \$1B, dec: 27).
- The command letters are transmitted directly.
- The coordinates xx and yy are transmitted as 16-bit binary values (first the LOW byte and then the HIGH byte).
- All the other parameters are transmitted as 8-bit binary values (1 byte).
- Strings (text) are concluded with CR (hex: \$0D) or LF (hex: \$0A) or NUL (hex: \$00).

No separating characters, such as spaces or commas, may be used in binary mode.

The commands require **no final byte**, such as a carriage return (apart from the string \$00).

## ALL COMMANDS AT A GLANCE

The built-in intelligence allows an easy creation of your individual screen content. Below mentioned commands can be used either directly via the serial interface (see page 12) or together with the selfdefinable macro.

Terminal commands				After reset	
Command	Codes		Remarks		
Form feed FF (dec:12)	^L		The contents of the screen are deleted and the cursor is placed at pos. (1,1)		
Carriage return CR(13)	^M		Cursor to the beginning of the line on the extreme left		
Line feed LF (dec:10)	^J		Cursor 1 line lower, if cursor in last line then scroll		
Position cursor	ESC	T	P C L	C=column; L=line; origin upper-left corner (1,1)	1,1
Cursor on/off			C n1	n1=0: Cursor is invisible; n1=1: Cursor flashes;	1
Save cursor position			S	The current cursor position is saved	
Restore cursor position			R	The last saved cursor position is restored	
Terminal off			A	Terminal display is switched off; outputs are rejected	
Terminal on	E	Terminal display is switched on;	On		
Output version	ESC	T	V	The version no. is output in the terminal (e.g. "EA eDIP160-7 V1.0 Rev.A")	
Output project name			J	The macro project name is output to the terminal (e.g. "init / delivery state")	
Output information	ESC	T	I	The terminal is initialized and deleted; software version, hardware revision, the macro project name and the CRC-checksum is output to the terminal	

Display commands (effect the entire display)				after reset	
Command	Codes		Remarks		
Set display orientation	ESC	D	O n1	n1=0: 0°; n1=1: 90°; n1=2: 180°; n1=3: 270°; (0°+180°=160x104; 90°+270°=104x160)	0°
Set display contrast			K n1	n1=0..40: Set display contrast to n1 (default = 20) n1='+' : increase contrast; n1='-' : decrease contrast	20
Set grayscale mode			G n1	n1=0: grayscale mode ON; flashing is possible n1=1: grayscale mode OFF; flashing not possible	0
Delete display	ESC	D	L	Delete display contents (all pixels off)	
Invert display			I	Invert display contents (invert all pixels)	
Fill display			S	Fill display contents (all pixels on)	
Switch display off			A	Display contents become invisible but are retained, commands are still possible	
Switch display on			E	Display contents become visible again	oN
Show clipboard			C	Show content of clipboard; Standard display outputs are no longer visible	
Show normal display content			N	Normal operation, standard display outputs are visible	

Clipboard commands (Buffer for display area)				after reset	
Command	Codes		Remarks		
Save display contents	ESC	C	B	The entire contents of the display are copied to the clipboard as an image area	
Save area			S x1 y1 x2 y2	The image area from x1,y1 to x2,y2 is copied to the clipboard	
Restore area			R	The image area on the clipboard is copied back to the display	
Copy area			K x1 y1	The image area on the clipboard is copied to x1,y1 in the display	

Straight lines and points				after reset	
Command	Codes		Remarks		
<b>Settings</b>					
Point size / line thickness	ESC	G	Z n1 n2	n1 = x-point size (1..15); n2 = y-point size (1..15);	1,1
Link mode			V n1	Set drawing mode n1: 1=set; 2=delete; 3=inverse	1
Blink attribute	ESC	G	B n1	n1:0=no blink; 1=on/off; 2=blink inverted; 3=off/on (phase shifted)	0
Gray-scale				n1:0=black solid line; 1=dark gray; 3=light gray (refer to command ESC DG)	
<b>Draw lines and points</b>					
Draw point	ESC	G	P x1 y1	Set a point at coordinates x1, y1	
Draw straight line			D x1 y1 x2 y2	Draw a straight line from x1,y1 to x2,y2	
Continue straight line			W x1 y1	Draw a straight line from the last end point to x1,y1	0, 0
Draw rectangle			R x1 y1 x2 y2	Draw four straight lines as a rectangle from x1,y1 to x2,y2	

Change / draw rectangular areas				after reset	
Command	Codes		Remarks		
Delete area	ESC	R	L x1 y1 x2 y2	Delete an area from x1,y1 to x2,y2 (all pixels off)	
Invert area			I x1 y1 x2 y2	Invert an area from x1,y1 to x2,y2 (invert all pixels)	
Fill area			S x1 y1 x2 y2	Fill an area from x1,y1 to x2,y2 (all pixels on)	
Area with fill pattern			M x1 y1 x2 y2 n1	Fill an area from x1,y1 to x2,y2 with pattern n1 (always set)	
Draw box			O x1 y1 x2 y2 n1	Draw rectangle from x1,y1 to x2,y2 with pattern n1 (always replace)	
Draw frame			R x1 y1 x2 y2 n1	Draw frame of type n1 from x1,y1 to x2,y2 (always set)	
Draw frame box			T x1 y1 x2 y2 n1	Draw frame box of type n1 from x1,y1 to x2,y2 (always replace)	



Text commands										after reset		
Befehl	Codes					Remarks						
<b>Settings</b>												
Set font	ESC	Z	F	n1		Set font with the number n1 = 0..15				0		
Set font zoom factor			Z	n1	n2	n1 = x-zoom factor (1x..4x); n2 = y-zoom factor (1x..4x)				1,1		
Additional line spacing			Y	n1	Insert n1 = 0..15 dots between two lines as additional spacing							0
Spacwidth			J	n1	Spacewidth: n1=0 use from font; n1=1 same width as number; n1>=2 width in dot							0
Text angle			W	n1	Text angle: n1=0: 0°; n1=1: 90°;							0
Text link mode	ESC	Z	V	n1	Mode n1: 1=set; 2=delete; 3=inverse; 4=replace; 5=inverse replace				4			
Text flashing attribute			B	n1	n1:0=no flashing; 1=on/off; 2=flash inversly; 3=off/on (phase shifted)				0			
Gray scale	n1:0=black; 1=dark gray; 3=light gray (refer to command: ESC DG)											
<b>Output strings</b>												
Output string L: left justified C: centered R: right justified	ESC	Z	L	x1	y1	Text ...	NUL	A string is output to x1,y1; string termination is: 'NUL' (\$00), 'LF' (\$0A) or 'CR' (\$0D); several lines are separated by the character ' ' (\$7C); Text between two '-' (\$7E): characters flashes on/off; Text between two '&' (\$26): characters flashes phase shifted; Text between two '@' (\$40): Zeichen stehen blinken Invertierend; The character '\' (\$5C, backslash) cancels the special funtion of characters ' ~@\''; e.g. "name\@test.de" => "name@test.de"				
			C									
			R									
String for terminal	ESC	Z	T	Text ...			Command to output a string (text...) from a macro to the terminal					

Bitmap commands										after reset		
Command	Codes					Remarks						
<b>Settings</b>												
Image zoom factor	ESC	U	Z	n1	n2	n1 = x-zoom factor(1x..4x); n2 = y-zoom factor (1x..4x)				1,1		
Image angle			W	n1	Image angle: n1=0: 0°; n1=1: 90°							0
Image link mode			V	n1	Mode n1: 1=set; 2=delete; 3=inverse; 4=replace; 5=inverse replace;							4
Image flashing attribute	ESC	Z	B	n1	n1:0=no flashing; 1=on/off; 2=flash inverted; 3=off/on (phase shifted)				0			
Image gray scale			n1:0=black; 1=dark gray; 3=light gray (refer to command ESC DG)									
<b>Output</b>												
Image from clipboard	ESC	U	C	x1	y1	The current contents of the clipboard are loaded to x1,y1 with all the image attributes						
Load internal image			I	x1	y1	nr	Load internal image with nr (0..255) from EEPROM to x1,y1					
Load image			L	x1	y1	BLH data ...						
<b>Hardcopy</b>												
Send hardcopy	ESC	U	H	x1	y1	x2	y2	An image area x1,y1 to x2,y2 is put into the sendbuffer. The image is send in BLH-format				

Bargraph commands										after reset				
Commands	Codes					Remarks								
<b>Definition</b>														
Define bargraph	ESC	B	R	n1	x1	y1	x2	y2	aw	ew	type	pat	Define bargraph with number n1 to l(left), r(right), o(up), u(down). x1,y1,x2,y2 are the surrounding rectangle of the bar. aw,ew are the values fo 0% and 100%. type=0:pattern bar; type=1:pattern bar in rectangle; pat=bar pattern type=2:line bar; type=3:line bar in rectangle; pat=line width	no bar defined
Delete bargraph			D										n2	The definition of bargraph n1 becomes invalid. If the bargraph was defined as an input by touch, the touch field will also be deleted
<b>Use</b>														
Update bargraph	ESC	B	A	n1	val	Set and draw the bargraph n1 to new val(ue).								
Redraw bargraph			Z	n1	Entirely redraw the bargraph n1.									
Send bargraph value			S	n1	Send the current value of the bargraph number n1									

Flashing commands										after reset	
Command	Codes					Remarks					
<b>Settings</b>											
Set flashing time	ESC	Q	Z	n1	Set flashing time to n1= 1..15 in 1/10s; 0=flashing deactivated				6		
<b>Flashing areas</b>											
Delete flashing attribute	ESC	Q	L	x1	y1	x2	y2	Delete the flashing attribute from x1,y1 to x2,y2. Do not use this command for phase shifted areas! (Copies the area from grafiklayer to blinklayer)			
Flashing inversely			I	x1	y1	x2	y2	Define an inverted flashing area from x1,y1 to x2,y2. (Copies the inverted area from grafiklayer to blinklayer)			
Flashing area pattern			M	x1	y1	x2	y2	n1	Define a flashing area (on/off) with pattern n1 frim x1,y1 to x2,y2 (Draw the pattern into blinklayer)		
<b>Phase shifted areas</b>											
Restore phase shifted area	ESC	Q	R	x1	y1	x2	y2	Delete the phase shifted flashing area from x1,y1 to x2,y2. Do not use this command for other flashing attributes! (Copues the area from blinklayer to grafiklayer)			
Inverted phase shifted area			E	x1	y1	x2	y2	Define a ophase shifted inverted flashing area frim x1,y1 to x2,y2. (Copies the inverted are from blinklayer to grafiklayer)			
Phase shifted flashing pattern			P	x1	y1	x2	y2	n1	Define a phase shifted flashing area (off/on) with pattern n1 from x1,y1 to x2,y2. (Draw the pattern into grafiklayer)		

Menu commands							after reset	
Command	Codes		Remarks					
<b>Settings for menu box/touch menu</b>								
Set menu font	ESC	N	F	n1			0	
Menu font zoom factor			Z	n1	n2		1,1	
Additional line spacing			Y	n1				
Menu angle			W	n1			0	
Touch menu automation			T	n1			1	
<b>Menu box commands (control not by touch)</b>								
Define and display menu	ESC	N	D	x1	y1	nr	Text ... NUL	A menu is drawn at the corner x1,y1 with the current font of menu nr:= currently inverted entry (e.g. 1 = first entry) Text...:= string with menu items. The different items are separated by the character ' ' ( \$7C,dez:124 e.g. "Item1 Item2 Item3" The background of the menu is automatically saved into the clipboard (previous content will be overwritten). If a menu is already defined, it is automatically canceled and deleted
Next item			N					The next item is inverted or remains at the end
Previous item			P					The previous item is inverted or remains at the beginning
End of menu/send			S					The menu is removed and replaced with the original background. The current item is sent as a number (1 to n; 0 = no menu displayed)
End of menu/macro			M	n1				The menu is removed and replaced with the original background. Menu macro n1 is called for item 1, menu macro n1+1 for item 2 and so on...
End of menu/cancel	A					The menu is removed and replaced with the original background		

Macro commands							after reset			
Command	Codes		Remarks							
<b>Call macros</b>										
Run normal macro	ESC	M	N	n1			Call the (normal) macro with the number n1 (max. 7 levels)			
Run touch macro			T	n1			Call the touch macro with the number n1 (max. 7 levels)			
Run menu macro			M	n1			Call the menu macro with the number n1 (max. 7 levels)			
Run port macro			P	n1			Call the port macro with the number n1 (max. 7 levels)			
Run bit macro			B	n1			Call the bit macro with the number n1 (max. 7 levels)			
<b>automatic (normal-) macros</b>										
Macro with delay	ESC	M	G	n1	n2		Call the (normal) macro with the number n1 in n2/10s. Execution is stopped by commands (e.g. receipt or touch macros)			
Automatic macros once only			E	n1	n2	n3		Automatically run macros n1 to n2 once only; n3 = pause in 1/10s. Execution is stopped by commands (e.g. receipt or touch macros)		
Automatic macros cyclically			A	n1	n2	n3		Automatically run macros n1 to n2 cyclically; n3 = pause in 1/10s. Execution is stopped by commands (e.g. receipt or touch macros)		
Automatic macros pin pong			J	n1	n2	n3		Automatically run macros n1 to n2 to n1 (ping pong); n3 = pause in 1/10s. Execution is stopped by commands (e.g. receipt or touch macros)		
<b>Macro processes</b>										
Define macro process	ESC	M	D	no	type	n3	n4	zs	A macro process with the number no (1 to 4) is defined (1=highest priority). The macros n3 to n4 are run successively every zs/10s. Type: 1=once only; 2=cyclical; 3=ping pong n3 to n4 to n3	
Macro process interval			Z	no	zs					A new time zs/10s is assigned to the macro process no (1 to4). If the time zs is set to 0, the execution is stopped.
Stop macro processes			S	n1						All macro processes are stopped with n1=0 and restarted with n1=1 in order, for example, to execute settings and outputs via the interface undisturbed.

General commands							after reset		
Command	Codes		Remarks						
<b>Backlight</b>									
Illumination brightness	ESC	Y	H	n1			Set brightness of the LED illumination to n1=0%..100%	100	
Brightness changetime			Z	n1			Time n1=0..31 in 1/10s for changing brightness from 0% to 100%	5	
Illumination on/off			L	n1			LED illumination n1=0: off; n1=1: on; n1=2 to 255: The illumination is switched on for n1/10s.	1	
Save parameter			@				Save actual brightness and changetime parameter for power on to EEPROM		
<b>Send commands</b>									
Send bytes	ESC	S	B	len		data ...	len (=1 to 255) bytes are sent to the sendbuffer data... = data to send. In the source text of the macro programming, the number len must not be specified. This is counted by the edipft-compiler and entered.		
Send version			V					The version is sent as a sting to sendbuffer, e.g. "EA eDIP160-7 V1.0 Rev.A TP+"	
Send projectname			J					The macro project name is sent as a sting to sendbuffer, e.g. "init / delivery"	
Send internal infos			I					Internal information about the eDIP is sent to the sendbuffer	
<b>Other commands</b>									
Wait (pause)	ESC	X	n1				Wait n1/10s before next command is executed		
Set RS485 address	ESC	K	A	adr			For RS232/RS485 operation only and only possible when Hardware address is 0. The eDIP is assigned a new address adr (in the Power-On-Macro).		
Tone on/off	ESC	Y	S	n1			The tone output (pin 16) becomes n1=0:OFF; n1=1:ON; n1=2 to 255:ON for n1/10s	OFF	
Power down	ESC	P	D	n1	n2		After this command, the display goes into power-down mode n1=0..2 (see page 9). n2=0: no wake-up by touch; n2=1: wake-up by touch possible		

I/O-Ports										after reset	
Command	Codes			Remarks							
<b>Input ports</b>											
Read input port			R	n1						n1=0: Read all input ports as binary value (to sendbuffer) n1=1..8: Read input port n1 (1=H-level=VDD, 0=L-level=GND)	
Port scan on/off	ESC	Y	A	n1						The automatic scan of the input port is n1=0 deactivated, n1=1 activated	1
Invert input port			I	n1						The input port is n1=0 is evaluated normal, n1=evaluated inverted	0
Redefine input bitmacro			D	n1	n2	n3					Input port n1=1..8 is assigned by falling edge n2=0 to BitMacro n3=0..255 Input port n1=1..8 is assigned by rising edge n2=1 to BitMacro n3=0..255
<b>Output ports</b>											
Define output port	ESC	Y	M	n1						n1=0: All 8 I/O-Ports are inputs IN1..IN8 (=default after Power-On / Reset) n1=1..8: n1 I/O-lines will be set to output (beginning at OUT1 upwards)	0
Write output port			W	n1	n2						n1=0: Set all defined output ports in accordance with n2 (=binary value) n1=1..8: Reset output port n1 (n2=0); set (n2=1); invert (n2=2)
<b>Port expansion with 74HC4094</b>											
Write extended ports	ESC	Y	E	n1	n2	n3				Set the outputs of the external 74HC4094 (refer to page 8) from port n1=0..255 to port n2=0..255; n3=0: low; n3=1: high; n3=2: invert	

## TOUCH PANEL(ONLY EAeDIP160x-7xxTP)

The -xxxTP versions are shipped with an analog, resistive touch panel. Up to 40 touch areas (keys, switches, menus, bar graph inputs) can be defined simultaneously. The fields can be defined with pixel accuracy. The display supports user-friendly commands (see page 17). When the touch “keys” are touched, they can be automatically inverted and an external tone can sound (pin 16), indicating they have been touched. The predefined return code of the “key” is transmitted via the interface, or an internal touch macro with the number of the return code is started instead (see page 22, Macro programming).

## FRAMES AND KEY SHAPES

A frame type can be set by using the Draw frame or Draw frame box command or by drawing touch keys. 18 frame types are available (0 = do not draw a frame). The frame size must be at least 16x16 pixels.

## BITMAPS AS KEYS

Apart from the frame types, which are infinitely scalable, it is also possible to use bitmaps (2 each, for not printed and printed) as touch keys or touch switches. You can use ELECTRONIC ASSEMBLY LCD-Tools\*) to integrate your own buttons as images (“PICTURE” compiler statement). A button always consists of two monochrome Windows BMPs of equal size (one bitmap to display the touch key in its normal state and one for when it is pressed). The active area of the touch key automatically results from the size of the button bitmaps.



## SWITCHES IN GROUPS (RADIO GROUP)

Touch switches (radio buttons) change their status from ON to OFF or vice versa each time they are touched. Several touch switches can be included in a group (‘ESC A R nr’ command). If a touch switch in the group ‘nr’ is switched on, all the other touch switches in this group are automatically switched off. Only one switch is ever on.

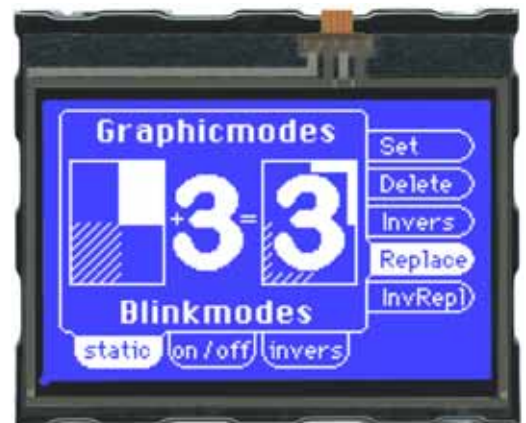

Commands for the touch panel											after reset		
Command	Codes				Remarks								
<b>Settings</b>													
Touch frame form	ESC	A	E	n1	The frame type for the display of touch keys/switches is set with n1						1		
Radio group for switches	ESC	A	R	nr	Only 1 switch in a group is active at any one time; all the others are deactivated. nr=0: newly defined switches do not belong to a group. nr=1 to 255: newly defined switches belong to the group with the number nr. In the case of a switch in a group, only the down code is applicable. the up code is ignored.						0		
<b>Touch: Label font</b>													
Label font	ESC	A	F	nr	Set font with the number n1 (0 to 31) for touch key label						0		
Label zoom factor			Z	n1	n2	n1 = X zoom factor (1x to 8x); n2 = Y zoom factor (1x to 8x)						1,1	
Add. line spacing			Y	n1	Insert n1 pixels (0 to 15) between two lines of text as additional line spacing								
Label angle			W	n1	Text output angle: n1=0: 0°; n1=1: 90°; n1=2: 180°; n1=3: 270°								0
<b>Touchbereiche definieren</b>													
Define touch key (key remains depressed as long as there is contact)	ESC	A	T	x1	y1	x2	y2	dow Cod	up Cod	Text ...	NUL	'T': The area from xx1,yy1 to xx2,yy2 is defined as a key. 'U': Image no. n1 is loaded to xx1,yy2 and defined as a key. 'down code':(1-255) Return/touch macro when key pressed. 'up code': (1-255) Return/touch macro when key released. (down/up code = 0 press/release not reported). 'text': the first character determines the alignment of the text (C=centered, L=left justified, R=right justified). this is followed by a string that is placed in the key with the current touch font. multiline texts are separated with the character ' ' (\$7C, dec: 124); 'nul': (\$00) = end of string	
			U	x1	y1	n1	dow Cod	up Cod	Text ...	NUL			
Define touch switch (status of the switch toggles after each contact)	ESC	A	K	x1	y1	x2	y2	dow Cod	up Cod	Text ...	NUL	'K': The area from xx1,yy1 to xx2,yy2 is defined as a switch. 'J': Image no. n1 is loaded to xx1,yy2 and defined as a switch. 'down code': (1-255) Return/touch macro when switched on. 'up code': (1-255) Return/touch macro when switched off. (down/up code = 0 on/off not reported). 'text': the first character determines the alignment of the text (C=centered, L=left justified, R=right justified). this is followed by a string that is placed in the key with the current touch font. multiline texts are separated with the character ' ' (\$7C, dec: 124); 'nul': (\$00) = end of string	
			J	x1	y1	n1	dow Cod	up Cod	Text ...	NUL			
Define touch key with menu function	ESC	A	M	x1	y1	x2	y2	dow Cod	up Cod	mnu Cod	Text ...	NUL	The area from xx1,yy1 to xx2,yy2 is defined as a menu key. 'down code':(1-255) Return/touch macro when pressed. 'up Code':(1-255) Return/touch macro when menu canceled 'mnu Code':(1-255) Return/menu macro+(item no. 1) after selection of a menu item. (down/up code = 0: activation/cancellation is not reported.) 'text':= string with the key text and the menu items. the first character determines the direction in which the menu opens (R=right, L=left, O=up, U=down). The second character determines the alignment of the touch key text (C=centered, L=left justified, R=right justified). The menu items are separated by the character ' ' (\$7C,dec:124) (e.g. "luc key item1 item2 item3"). The key text is written with the current touch font and the menu items are written with the current menu font. The background of the menu is saved automatically.
Define drawing area	ESC	A	D	x1	y1	x2	y2	n1	A drawing area is defined. You can then draw with a line width of n1 within the corner coordinates xx1,yy1 and xx2,yy2.				
Define free touch area	ESC	A	H	x1	y1	x2	y2	A freely usable touch area is defined. Touch actions (down, up and drag) within the corner coordinates xx1,yy1 and xx2,yy2 are sent.					
Set bar by touch	ESC	A	B	nr	The bar graph with the no. n1 is defined for input by touch panel.								
<b>Global settings</b>													
Touch query on/off	ESC	A	A	n1	Touch query is deactivated (n1=0) or activated (n1=1);						1		
Touch key response	ESC	A	I	n1	Automatic inversion when touch key touched: n1=0=OFF; n1=1=ON;						1		
			S	n1	Tone sounds briefly when a touch key is touched: n1=0=OFF; n1=1=ON						1		
Send bar value automatically	ESC	A	Q	n1	The Automatic transmission of a new bar graph value by touch input is deactivated (n1=0); a new value is sent after setting (n1=1); each change is sent during setting (N1=2).						1		
<b>Other commands</b>													
Invert touch key	ESC	A	N	Cod	The touch key with the assigned return code is inverted manually								
Set touch switch			P	Cod	n1	The status of the switch is changed by means of a command (n1=0=off; n1=1=on).							
Query touch switch			X	Cod	The status of the switch (off=0; on=1) is placed in the send buffer.								
Radiogroup abfragen			G	nr	Der downcode des aktivierten Schalters aus der Radiogroup mit der Nummer nr wird in den Sendepuffer gestellt.								
Delete touch area	ESC	A	L	Cod	n1	The touch area with the return code (code=0: all touch areas) is removed from the touch query. When n1=0, the area remains visible on the display; when n1=1, the area is deleted.							
			V	x1	y1	n1	remove the Touch area that includes the coordinates xx1,yy1 from the touch query. n1=0: area remains visible; n1=1: Delete area						

## ADJUSTTOUCHPANEL

The touch panel is perfectly adjusted and immediately ready for operation on delivery. As a result of aging and wear, it may become necessary to readjust the touch panel.

Adjustment procedure:

1. Touch the touch panel at power-on and keep it depressed. After the message "touch adjustment?" appears, release the touch panel again (or issue the 'ESC @' command).
2. Touch the touch panel again within a second for at least a second.
3. Follow the instructions for adjustment (press the 2 points upper left and lower right).

## RESPONSES OF THE EA EDIP160-7 VIA SERIAL INTERFACE

The table below contains all response codes. Some response data will come automatically some others on request. In addition to that with command 'ESC SB ...' user is able to transmit individual data packages. All responses are placed into the sendbuffer. With the small protocol command 'Request for content of send buffer' (see page 10) the host can read out the sendbuffer. This can be done per polling, alternatively pin 20 'SBUF' shows with Low-level that data is ready to transmit.

Responses of the eDIP								
Id	num	data			Remarks			
<b>automatic responses (placed into sendbuffer)</b>								
ESC	A	1	code			Response from the analog touch panel when a key/switch is pressed. code = down or up code of the key/switch. It is only transmitted if no touch macro with the number code is defined !		
ESC	B	2	no	value		When a bargraph is set by touch, the current value of the bar no is transmitted. Transmission of the bar value must be activated (see the 'ESC A Q n1' command).		
ESC	N	1	code			After a menu item is selected by touch, the selected menu item code is transmitted. It is only transmitted if no touch macro is defined with the number code.		
ESC	T	0				If automatic opening of a touch menu is disabled (see 'ESC NT n1'), this request is sent to the host computer. The host can then open the touch menu with the 'ESC N T 2' command.		
ESC	P	1	value			After the input port is changed, the new 8-bit value is transmitted. The automatic port scan must be activated. See the 'ESC Y A n1' command. It is only transmitted when there is no corresponding port/bit macro defined !		
ESC	H	5	type	xLO	xHI	yLO	yHI	The following is transmitted in the case of a free touch area event: type=0 is release; type=1 is touch; type=2 is drag within the free touch area at the coordinates xx1, yy1
<b>Response only when requested by command (placed into sendbuffer)</b>								
ESC	N	1	no					After the 'ESC N S' command, the currently selected menu item is transmitted. no=0, no menu item is selected
ESC	B	2	no	value				After the 'ESC B S n1' command, the current value of the bar with the number no is transmitted.
ESC	X	2	code	value				After the 'ESC A X' command, the current status (value=0 or 1) of the touch switch code is transmitted.
ESC	G	2	no	code				After the 'ESC A G nR' command, the code of the active touch switch in the radio group no is sent.
ESC	Y	2	no	value				After the 'ESC Y R' command, the requested input port is transmitted. no=0: value is an 8-bit binary value of all 8 inputs. no=1..8: value is 0 or 1 depending on the status of the input no
ESC	V	num		version string...				After the 'ESC S V' command, the version of the edip firmware is transmitted as a string e.g. "EA eDIP160-7 V1.0 Rev.A TP+"
ESC	J	num		projectname string...				After the 'ESC S J' command, the macro-projectname is transmitted. e.g. "init / delivery state"
ESC	I	21		X-dots, Y-dots, Version, Touchinfo, CRC-ROM, CRC-ROMsoll, DF in KB, CRC-DF, CRC-DFsoll, DFlen				after the 'ESC S I' command, internal information is sent by eDIP (16-Bit integer values LO-HI Byte) Version: LO-Byte = version number Software; HI-Byte = Hardware revision letter touch Touchinfo: LO-Byte = '- +' X direction detected; HI-Byte = '- +' Y direction detected DFlen: number of user bytes in data flash memory (3 Bytes: LO-, MID- HI-Byte)
<b>Responses without length specification (num)</b>								
ESC	U	L	xx1	yy1	image data... (G16-F)			after the 'ESC UH...' command, a hard copy is sent in BLH Format. xx1,yy1 = Start coordinates of the hard copy (upper corner) BLH-Data: 2 Byte: Width, height (in Pixel)+ amount of bytes of image data amount = ((width+7)/8)*height
ESC	U	G	xx1	yy1	image data... (G16-FORMAT)			In gray-scale mode, a second time 'amount of image data' is send for flashing mode





+ Lower Upper	\$0 (0)	\$1 (1)	\$2 (2)	\$3 (3)	\$4 (4)	\$5 (5)	\$6 (6)	\$7 (7)	\$8 (8)	\$9 (9)	\$A (10)	\$B (11)	\$C (12)	\$D (13)	\$E (14)	\$F (15)
\$20 (dez: 32)		!	"	#	\$	%	&	'	( )	*	+	,	-	.	/	
\$30 (dez: 48)	0	1	2	3	4	5	6	7	8	9	:	;	<	=	>	?
\$40 (dez: 64)	@	A	B	C	D	E	F	G	H	I	J	K	L	M	N	O
\$50 (dez: 80)	P	Q	R	S	T	U	V	W	X	Y	Z	[ \ ]	^	_		
\$60 (dez: 96)	`	a	b	c	d	e	f	g	h	i	j	k	l	m	n	o
\$70 (dez: 112)	p	q	r	s	t	u	v	w	x	y	z	{   }	~	Δ		
\$80 (dez: 128)	€	ü	é	â	ä	à	â	ç	ê	ë	è	ï	î	ï	Ä	Å
\$90 (dez: 144)	É	æ	Æ	ô	ö	ò	û	ù	ÿ	ö	ü					
\$A0 (dez: 160)	á	í	ó	ú	ñ	Ñ	à	ç								
\$B0 (dez: 176)																
\$C0 (dez: 192)																
\$D0 (dez: 208)																
\$E0 (dez: 224)		ß														
\$F0 (dez: 240)																

Font 5: CHICAGO14 proportional

## ADDITIONAL FONTS

Compile statement "WinFont:"

It is possible to raster TrueType-Fonts in different sizes which can be used. A doubleclick to the fontname within the KitEditor opens the font selection box. To simplify the use of fonts, there is the possibility of an edit box. If you output a string with KitEditor (e.g. #ZL 5,5, "Hello"), you can perform a double click on the string to open it. Now you can select the desired characters. This is mainly recommended using cyrillic, asian or symbol fonts.

In that way, the KitEditor automatically places the right ASCII-Code. Alternativly you can use instead of the quotation mark curly brackets (e.g. #ZL 5,5, {48656C6C6F}).

Compiler option "Font:"

Following font formats can be used:

- FXT: Textfont as used by eDIP240/320 and KIT series

+ Lower Upper	\$0 (0)	\$1 (1)	\$2 (2)	\$3 (3)	\$4 (4)	\$5 (5)	\$6 (6)	\$7 (7)	\$8 (8)	\$9 (9)	\$A (10)	\$B (11)	\$C (12)	\$D (13)	\$E (14)	\$F (15)
\$20 (dez: 32)		!	"	#	\$	%	&	'	( )	*	+	,	-	.	/	
\$30 (dez: 48)	0	1	2	3	4	5	6	7	8	9	:	;	<	=	>	?
\$40 (dez: 64)	@	A	B	C	D	E	F	G	H	I	J	K	L	M	N	O
\$50 (dez: 80)	P	Q	R	S	T	U	V	W	X	Y	Z	[ \ ]	^	_		
\$60 (dez: 96)	`	a	b	c	d	e	f	g	h	i	j	k	l	m	n	o
\$70 (dez: 112)	p	q	r	s	t	u	v	w	x	y	z	{   }	~	Δ		
\$80 (dez: 128)	€	ü	é	â	ä	à	â	ç	ê	ë	è	ï	î	ï	Ä	Å
\$90 (dez: 144)	É	æ	Æ	ô	ö	ò	û	ù	ÿ	ö	ü					
\$A0 (dez: 160)	á	í	ó	ú	ñ	Ñ	à	ç								
\$B0 (dez: 176)																
\$C0 (dez: 192)																
\$D0 (dez: 208)																
\$E0 (dez: 224)		ß														
\$F0 (dez: 240)																

Font 6: Swiss30 Bold proportional



integrated fonts in delivery state



Edit Box

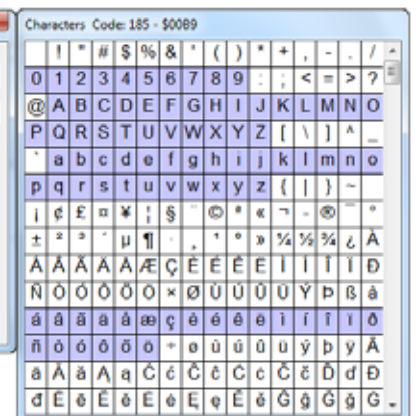
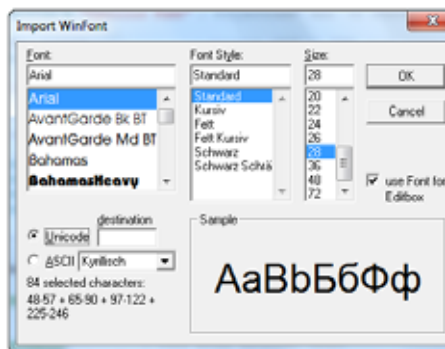

Import WinFonts

### DISPLAY BLINK MODE

After power on or the command 'ESC DG 0' the eDIP160 is in blink mode. Two picture contents are alternatly shown in an adjustable period.

Blink attributs are set by the commands 'ESC ZB, UB, GB n1':

- n1=0: no blink
- n1=1: On/Off blink
- n1=2: blink inverted
- n1=3: Off/On blink (phase shifted)

Between strings ('ESC ZL,ZC,ZR. ..), flashing can be activated locally:

- Strings between two '~' (\$7E) mean blink on/off.
- Strings between two '&' (\$26) mean blink off/on phase shifted.
- Strings between two '@' (\$40) mean blink inverted.

In addition you can assign or delete postly an rectangle area a blink mode, by using the command 'ESC Q...'



### DISPLAY GRAYSCALE

After the command 'ESC DG 1' the eDIP160 is in grayscale mode. Flashing is no longer possible, instead the blink mode is used for two grayscales.

Gray colours are generated with the help of the flashing modes 'ESC ZB, UB, GB n1':

- n1=0: Black
- n1=1: Dark gray
- n1=3: light gray

Within strings (ESC ZL, ZC, ZR...), gray characters can be used locally:

- Text between two '~' (\$7E) are dark gray.
- Text between two '&' (\$26) are light gray.

In addition rectangular areas can be filled gray or black postly, with the use of commands of flashing areas ('ESC Q...').



```
Macro: MnAutoStart
#TA ; Terminal off

#AR 1 ; define radiogroup
#AE 13 ; define frame
#AF CHICAGO14 ; define touchlabelfont
#AK 20,30, 70,50, 1,0, "BLINK" ; place button „blink“
#AK 100,30,150,50, 2,0, "GRAY" ; place button „gray“

#ZF SWISS30B ; select textfont
#ZC 45,35, "~OnOff~|&OffOn&" ; place blink text
#ZC 125,35, "~dark~|&light&" ; place gray text

TouchMacro: 1 ; Flashing
#DG 0 ; grayscalemode off -> flashing possible

TouchMacro: 2 ; Grayscale modus
#DG 1 ; grayscalemode on -> flashing impossible

Example code of the hardcopies
```

## MACRO PROGRAMMING

Single or multiple command sequences can be grouped together in macros and stored in the data flash memory. You can then start them by using the Run macro commands. There are different types of macro (compiler directive marked in green letters):

### Normal macro Macro:

These are started by means of an 'ESC MN xx' command via the serial interface or from another macro. A series of macros occurring one after the other can be called cyclically (movie, hourglass, multi-page help text). These automatic macros continue to be processed until either a command is received via the interface or a touch macro with a corresponding return code is activated.

### Touch macro TouchMacro:

Started when you touch/release a touch field (only in versions with a touch panel - TP) or issue an 'ESC MT xx' command.

### Menu macro (1 to 255) MenuMakro:

Started when you choose a menu item or issue an 'ESC MM xx' command.

### Bit macro BitMacro:

will be started by a single line IN 1..8 (bit) will change or by command 'ESC MB xx'. Bit-Macro 1..8 are good for falling edge and Bit Macro 9..16 are good for rising edge at input 1..8. It is possible to change the assignment between Bitmacro and input with command 'ESC YD n1 n2 n3' (see page 17).

### Port macro PortMacro:

These are started when voltage (binary) is applied to IN 1..8 or by command 'ESC MP xx'.

### Power-on-macro PowerOnMacro:

Started after power-on. You can switch off the cursor and define an opening screen, for example.

### Reset-macro ResetMacro:

Started after an external reset (low level at pin 5).

### Watchdog-macro WatchdogMacro:

Started after a fault/error (e.g. failure).

### Brown-out-macro BrownOutMacro:

Started after a voltage drop under 3.0V (typ.).

### Wake-up-pin-macro WakeupPinMacro:

Started after wake up from power-down-mode with pin 13 (WUP).

### Wake-up touch-Macro WakeupTouchMacro:

Started after wake up from power-down-mode with touch (the whole touch area is active).

### Wake-up I2C-Macro WakeupI2CMacro:

Started after wake up from power-down-mode with the I<sup>2</sup>C bus.

**Important:** If a continuous loop is programmed in a power-on, reset, watchdog or brown-out macro, the display can no longer be addressed. In this case, the execution of the power-on macro must be suppressed. You do this by wiring DPOM:  
- PowerOff - connect pin 13 (DPOM) to GND  
- PowerOn - open pin 13 (DPOM) again.

## STORING IMAGES IN THE DATA FLASH MEMORY

To reduce the transmission times of the interface or to save storage space in the processor system, up to 256 images can be stored in the internal EEPROM with the "PICTURE" compiler directive. They can be called using the "ESC U I" command or from within a macro.

All images in the Windows BMP format (monochrome images only) can be used. They can be created and edited using widely available software such as Windows Paint or Photoshop or the bitmap editor shipped with the product.

## CREATING INDIVIDUAL MACROS AND IMAGES

To create your own fonts, images, animations and macros you need the following:

- To connect the display to the PC, you need the EA 9777-2USB USB evaluation board, which is available as an accessory, or a self-built adapter with a MAX232 level converter (see the application example on page 5).
- ELECTRONIC ASSEMBLY LCD-Tools\*), which contains a kiteditor, bitmappeditor, ediptftcompiler, fonts, images, border, pattern and examples (for Windows PCs)
- A PC with an USB or serial COM interface

To define a sequence of commands as a macro, all the commands are written to a file on the PC (e.g. DEMO.KMC). You specify which character sets are to be integrated and which command sequences are to be in which macros. If the macros are defined using the kit editor, you start the eDIP compiler using F5. This creates a file called DEMO.EEP. If an EA 9777-2USB evaluation board is also connected or the display is connected to the PC via a MAX232, this file is automatically burned in the display's data memory.

You can send the created macrofile \*.EEP with any other system to the EA eDIP160-7. All programming commands are inside this file, so you only need to send the content of the \*.df file (via RS232, SPI or I2C with smallprotocol in packets) to the EA eDIP160-7.

## KIT-EDITOR HELP (ELECTRONIC ASSEMBLY LCDTOOLS)

At bottom from the KitEditor window in the statusline you can see a short description for the current command and the parameters. For more information press F1.



\*) im Internet unter <http://www.lcd-module.de/deu/dip/edip.htm>



## SPECIFICATION AND ELECTRICAL CHARACTERISTICS

Characteristics					
Value	Condition	min.	typ.	max.	Unit
Operating Temperature		-20		+70	°C
Storage Temperature		-30		+80	°C
Storage Humidity	< 40°C			90	%RH
Operating Voltage		3.2		5.2	V
Input Low Voltage		-0.5		0.2*VDD	V
Input High Voltage	Pin Reset only	0.9*VDD		VDD+0.5	V
Input High Voltage	except Reset	0.6*VDD		VDD+0.5	V
Input Leakage Current				1	uA
Input Pull-up Resistor		20		50	kOhms
Output Low Voltage				0.7	V
Output High Voltage	VDD = 3,3V VDD = 5V	2.5 4.2			V
Output Current				20	mA
Current Backlight on	VDD = 3,3V VDD = 5V		190 125		mA
Current Backlight off	VDD = 3,3V VDD = 5V		10 15		mA
Power Down	Mode 0		25		µA

### MOUNTING BEZEL EA 0FP161-7SW

As accessory we deliver an optional black anodized mounting bezel. The mounting clips are included in the supplied EA eDIP160-7.

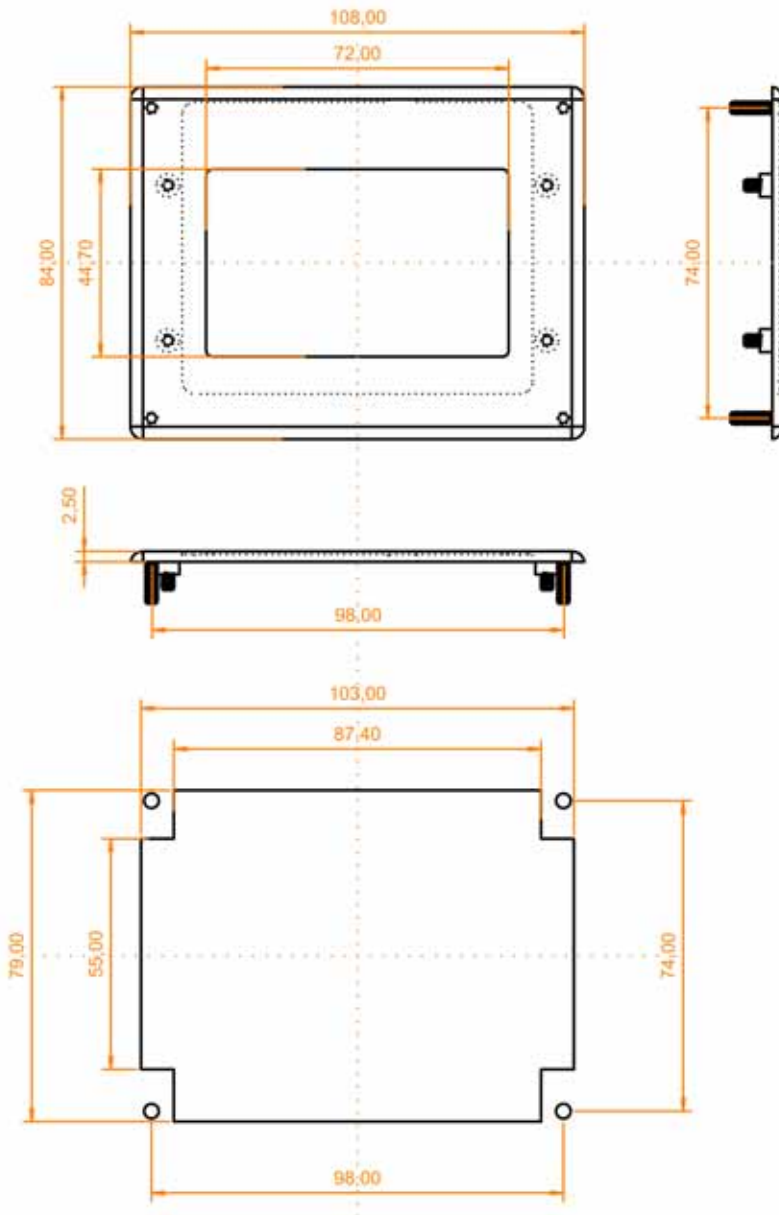

*all dimensions are in mm*



### NOTES ON HANDLING AND OPERATION

- The module can be destroyed by polarity reversal or overvoltage of the power supply; overvoltage, reverse polarity or static discharge at the inputs; or short-circuiting of the outputs.
- It is essential that the power supply is switched off before the module is disconnected. All inputs must also be deenergized.
- The display and touch screen are made of plastic and must not come into contact with hard objects. The surfaces can be cleaned using a soft cloth without solvents.
- The module is designed exclusively for use in buildings. Additional measures have to be taken if it is to be used outdoors. The maximum temperature range of -20 to +70°C must not be exceeded. If used in a damp environment, the module may malfunction or fail. The display must be protected from direct sunshine.

## NOTES

**NOTES**

