

Display Elektronik GmbH

DATA SHEET

TFT- MODULE

DEM 800480P TMH-PW-N

7,0" TFT

Product Specification

Ver.: 4

22.06.2015

Contents

1. General Description and Features	4
1.1 Features	4
1.2 LCD Module	4
2. Mechanical Information	4
3. Electrical Specifications	5
3.1 Absolute Max. Ratings	5
3.2 AC Timing Characteristic of The LCD	6
3.3 Back-Light Unit	9
4. Optical Characteristics	10
4.1 Optical characteristic of the LCD	10
5. I/O Terminal	12
5.1 Pin Assignment	12
5.2 Back Light Unit	13
5.3 Block Diagram	13
6. Display color and Input Data	15
7. Reliability Condition	15
8. Dimensional Outlines	16
9. Incoming Inspection Standards	18

1. General Description and Features

DEM 800480P TMH-PW-N is a transmissive type color active matrix TFT (Thin Film Transistor) liquid crystal display (LCD) that uses amorphous silicon TFT as a switching device. This model is composed of a TFT-LCD module, a driver circuit and a back-light unit. Graphics and texts can be displayed on a WVGA 800 (W) x RGB x 480 (H) dots (16:9 aspect ratio) with 262,144 colors by supplying 18 bits data signal (6bits/each color). The following table described the features of DEM 800480P TMH-PW-N.

1.1 Features

- Transmissive and backlight with 39 LEDs are available.
- TN (Twisted Nematic) mode.
- Digital RGB (6bits/each color) data transfer.
- Data enable mode.
- ROHS Compliance

1.2 LCD Module

Item	Specification	Unit
Screen Size	7.0 Inches	Diagonal
Display Resolution	800 x RGB x 480	Pixel
Active Area	152.40 x 91.44	mm
Outline Dimension	166.60 x 109.40 x 9.65	mm
Display Mode	Normally White Mode / Transmissive	--
Pixel Arrangement	R,G,B Vertical Stripe	--
Pixel Size	0.1905 x 0.1905	mm
Surface Treatment	Anti-Glare and Hard Coating(3H)	
Display Color	262k	--
Viewing Direction	6 o'clock	--
Input Interface	18-Bit-Digital-RGB (6-Bits/each Color) Data Transfer	--

2. Mechanical Information

Item	Min.	Typ.	Max.	Unit	Note
Module Size	Horizontal (H)	--	166.60	--	mm
	Vertical (V)	--	109.40	--	mm
	Thickness (T)	--	9.65	--	mm (1)
Weight	--	(164)	--	g	--

Note (1) Not Include Component. Refer to the Outline Dimension Drawing as attached.

3. Electrical Specifications

3.1 Absolute Max. Ratings

3.1.1 Absolute Ratings of Environment

If the operating condition exceeds the following absolute maximum ratings, the TFT LCD module may be damaged permanently.

(Ta=25±2°C, Vss=GND=0)

Item	Symbol	Min.	Max.	Unit	Note
Storage Temperature	T _{STG}	-30	80	°C	(1)
Operating Temperature	T _{OPR}	-20	70	°C	(1,2,3)

Note (1) 95 % RH Max. (40°C ≥ Ta). Maximum wet-bulb temperature at 39 °C or less.
(Ta > 40°C) No condensation.

Note (2) In case of below 0°C, the response time of liquid crystal (LC) becomes slower and the color of panel becomes darker than normal one. Level of retardation depends on temperature, because of LC's character

Note (3) Only operation is guaranteed at operating temperature. Contrast, response time, another display quality are evaluated at +25°C.

3.1.2 Electrical Absolute Maximum Ratings

3.1.2.1 TFT-LCD Module

(Vss=GND=0)

Parameter	Symbol	Min.	Max.	Unit	Remark
Power Supply Voltage	V _{CC}	-0.3	4.0	V	

3.1.2.2 Backlight Unit

(Vss=GND=0)

Parameter	Symbol	Min.	Max.	Unit	Remark
Current of Backlight Unit	IB	--	325	mA	
Voltage of Backlight Unit	VB	--	10.5	V	

3.1.3 DC Electrical Characteristics of the TFT LCD

(Ta=25±2°C, V_{SS}=GND=0)

Item	Symbol	Min.	Typ.	Max.	Unit	Remark
Power Supply	VCC	3.0	3.3	3.6	V	
Input Voltage for Logic	H Level	V _{IH}	0.7xVCC	-	VCC	V
	L Level	V _{IL}	0	-	0.3xVCC	V
Power Supply Current	ICC	-	(190)	(250)	mA	Note 1

Note1: f_v =60Hz, Ta=25°C, Display pattern: Black pattern

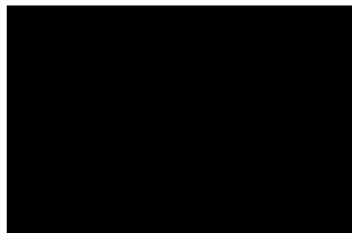

3.2 AC Timing Characteristic of The LCD

3.2.1 Timing Condition (DE only mode)

Signal	Parameter	Symbol	Min.	Typ.	Max.	Unit.	Remark
DCLK	CLK frequency	F _{CPH}	29.4	33.26	42.48	MHz	
	CLK period	T _{CPH}	-	30.06	-	ns	
	CLK pulse duty	T _{CWH}	40	50	60	%	
DE	DE period	T _{DEH} +T _{DEL}	1000	1056	1200	T _{CPH}	
	DE pulse width	T _{DEH}	-	800	-	T _{CPH}	
	DE frame blanking	T _{DEB}	10	45	110	T _{DEH} +T _{DEL}	
	DE frame width	T _{DE}	-	480	-	T _{DEH} +T _{DEL}	
	DE setup time	T _{esu}	6	-	-	ns	
Data	Data setup time	T _{dsu}	6	-	-	ns	
	Data hold time	T _{dhd}	6	-	-	ns	

3.2.2 Timing Characteristic

3.2.2.1 DE and RGB Data Input Timing

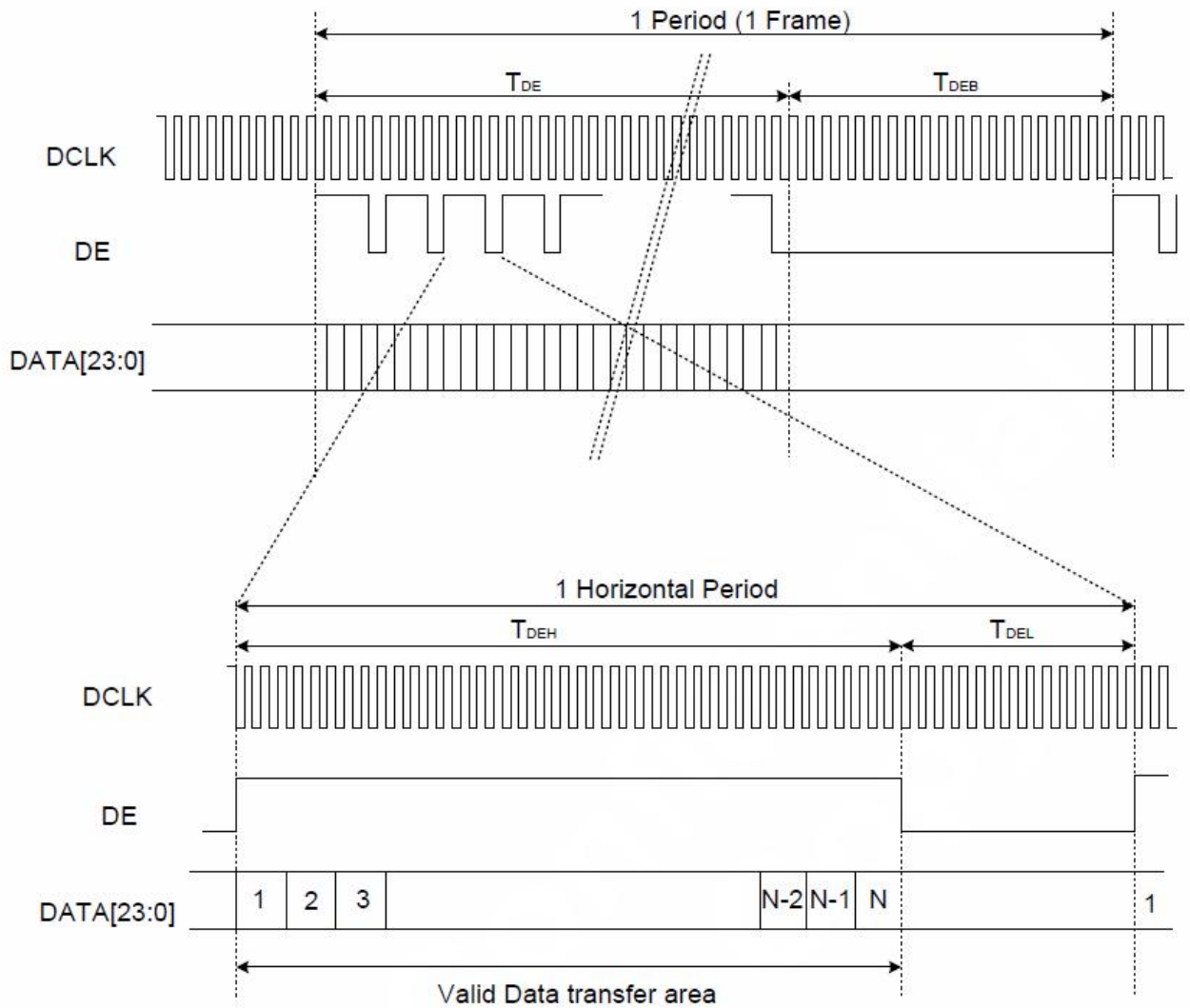

3.2.2.2 Clock and Data input waveforms

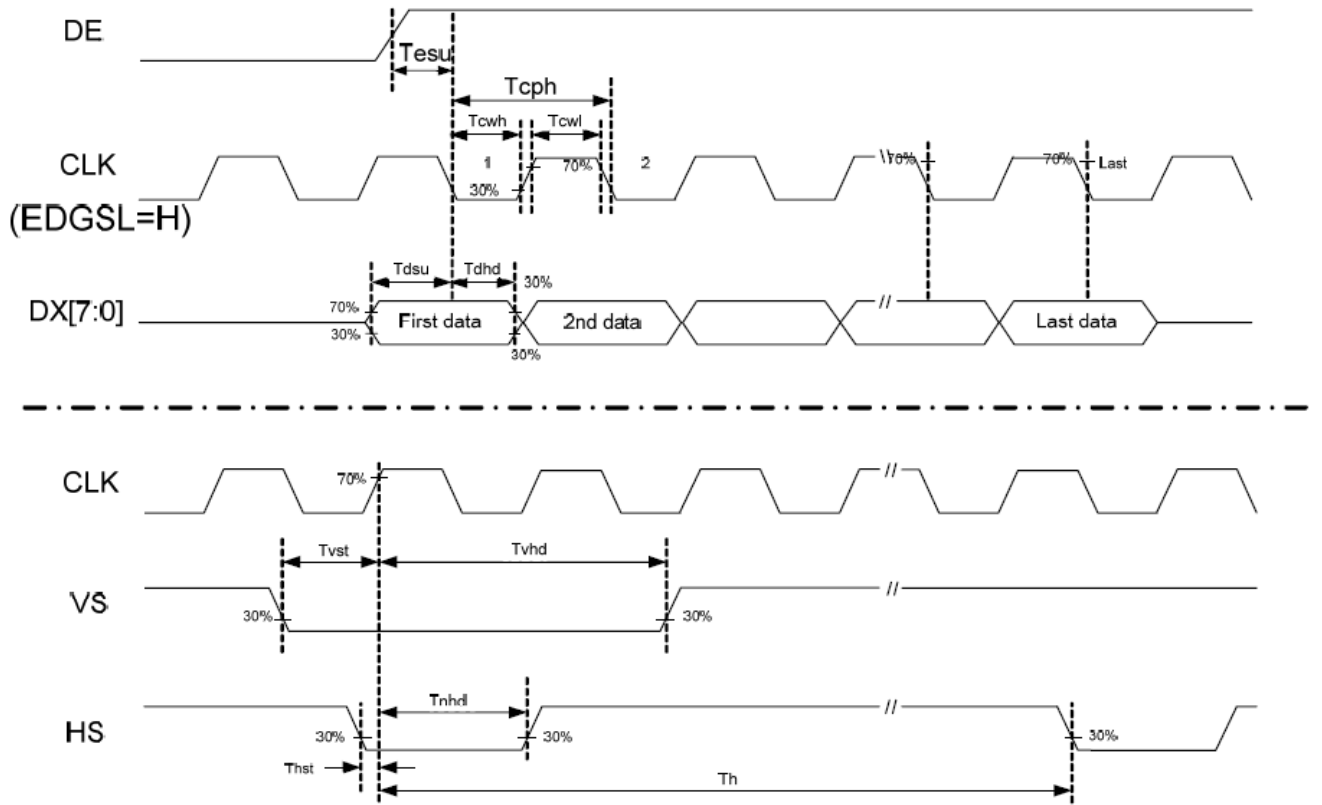

3.3 Backlight Unit

The Back-light system is an edge-lighting type with 39 white LED (Light Emitting Diodes).
The characteristics of 39 white LEDs are shown in the following tables.

(Ta= Room Temp)

Characteristics	Symbol	Min.	Typ.	Max.	Unit	Note
Forward Voltage	VB	(9.0)	(9.9)	(10.5)	V	
Forward Current	IB	-	260	-	mA	(1)
Power Consumption	P _{BL}	-	2574	-	mW	(2)
LED Lifetime	-	(50000)	-	-	hr	(3)

Note (1) LEDs in 3 series x 13 parallel type.

(2) Where $IB = 260\text{mA}$, $VB = 9.9$, $P_{BL} = VB \times IB$

(3) The environmental conducted under ambient air flow, at $Ta=25\pm 2^{\circ}\text{C}$, $60\%\text{RH}\pm 5\%$

4. Optical Characteristics

4.1 Optical characteristic of the LCD

The following items are measured under stable conditions. The optical characteristics should be measured in a dark room or equivalent state with the methods.

Measuring equipment: BM-7A

Item	Symbol	Condition	Min	Type	Max	Unit	Note	
Brightness	B		(800)	(1000)	--	cd/m ²		
Response Time	T _r	θ=0°	-	5	10	ms	.	
	T _f		--	15	20	ms		
Contrast Ratio	CR	At optimized viewing angle	(350)	(400)	--	--		
Luminance Uniformity	ΔL		70	75		%		
Color Chromaticity (CIE 1931)	White	W _x	θ=0° Normal Viewing Angle	(0.270)	(0.320)	(0.370)	--	BM-7A
		W _y		(0.300)	(0.350)	(0.400)		
Viewing Angle (6H)	Hor.	θ _R	CR≥10	55	65	--	Degree	
		θ _L		55	65	--		
	Ver.	θ _U		45	55	--		
		θ _D		55	65	--		

a. Test equipment setup

After stabilizing and leaving the panel alone shall be warmed up for the stable operation of LCM, the measurement should be executed. Measurement should be executed in a stable, windless, and dark room. Optical specifications are measured by Topcon BM-7(fast) with a viewing angle of 2° at a distance of 50cm and normal direction.

b. Definition of response time: Tr and Tf

The response time is defined as the following figure and shall be measured by switching the input signal for "black" and "white".

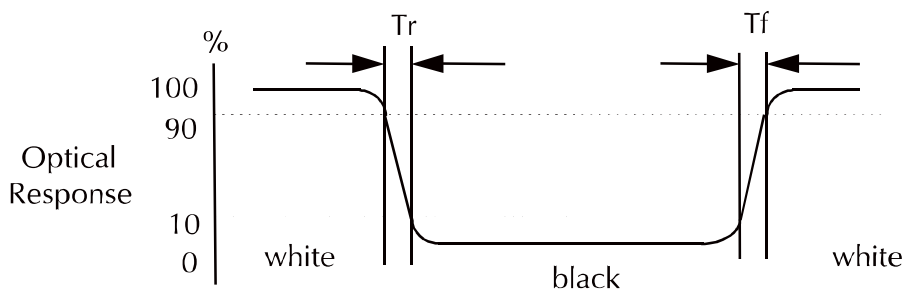

c. Definition of contrast ratio:

$$\text{Contrast Ratio (CR)} = \frac{\text{Brightness measured when LCD is at "white state"}}{\text{Brightness measured when LCD is at "black state"}}$$

- d. Measured at the center area of the panel when all the input terminals of LCD panel are electrically opened.
- e. View Angle

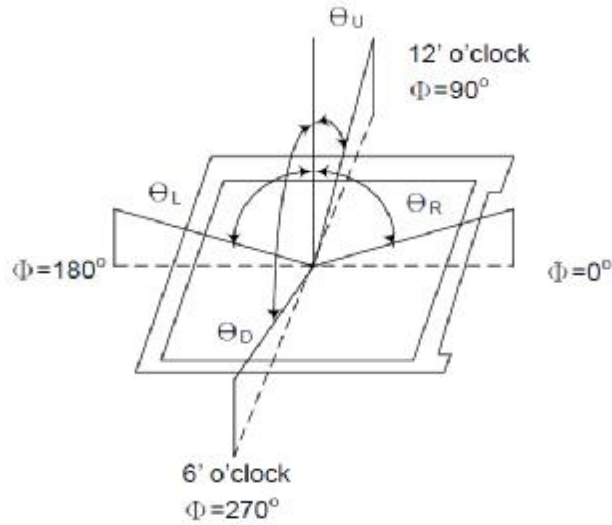

- f. Definition of Luminance of White: Luminance of white at the center points

Light Source of Back-Light Unit	LED Type
---------------------------------	----------

- g. Definition of White Uniformity

$$\text{White Uniformity} = \frac{\text{Min. luminance of white among 9-points}}{\text{Max. luminance of white among 9-points}} \times 100\%$$

- h. The definition of Color Gamut -Color Chromaticity CIE 1931

Color coordinate of white & red, green, blue at center point.

Color Gamut : NTSC(%) = (RGB Triangle Area / NTSC Triangle Area) x 100

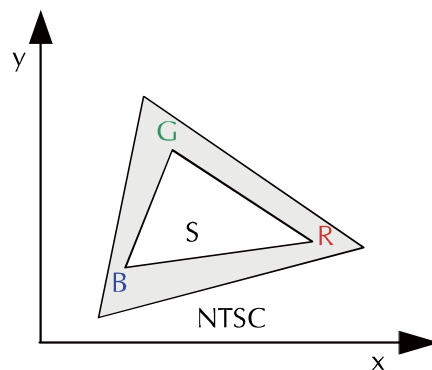

5. I/O Terminal**5.1 Pin Assignment** (connector Part No: JAE FA5B040HP1 or equivalent.)

Pin No.	Symbol	I/O	Function	Remark
1	VCC	P	Power Supply +3.3V	
2	VCC	P	Power Supply +3.3V	
3	VCC	P	Power Supply +3.3V	
4	VCC	P	Power Supply +3.3V	
5	NC	-	NO Connect	
6	DE	I	Data Enable signal	
7	VSS	P	Ground	
8	NC	-	NO Connect	
9	VSS	P	Ground	
10	NC	-	NO Connect	
11	VSS	P	Ground	
12	B5	I	Blue data signal (MSB)	
13	B4	I	Blue data signal	
14	B3	I	Blue data signal	
15	VSS	P	Ground	
16	B2	I	Blue data signal	
17	B1	I	Blue data signal	
18	B0	I	Blue data signal (LSB)	
19	VSS	P	Ground	
20	G5	I	Green data signal (MSB)	
21	G4	I	Green data signal	
22	G3	I	Green data signal	
23	VSS	P	Ground	
24	G2	I	Green data signal	
25	G1	I	Green data signal	
26	G0	I	Green data signal (LSB)	
27	VSS	P	Ground	
28	R5	I	Red data signal (MSB)	
29	R4	I	Red data signal	
30	R3	I	Red data signal	
31	VSS	P	Ground	
32	R2	I	Red data signal	
33	R1	I	Red data signal	
34	R0	I	Red data signal (LSB)	
35	NC	-	NO Connect	
36	VSS	P	Ground	
37	VSS	P	Ground	
38	DCLK	I	Data Clock	
39	VSS	P	Ground	
40	VSS	P	Ground	

I: Input, P: Power Notes:

- 1) NC Pin must be retained; this pin can't contact VSS or other signal.
- 2) VSS Pin must ground contact, can not be floating.

5.2 Backlight Unit (Connector Part No: JST: BHSR-02VS-01(N) or equivalent.)

Pin No.	Symbol	Function	Remark
1	LEDA	Power Supply for LED backlight	RED
2	LEDK	GND for LED backlight	BLACK

5.3 Block Diagram

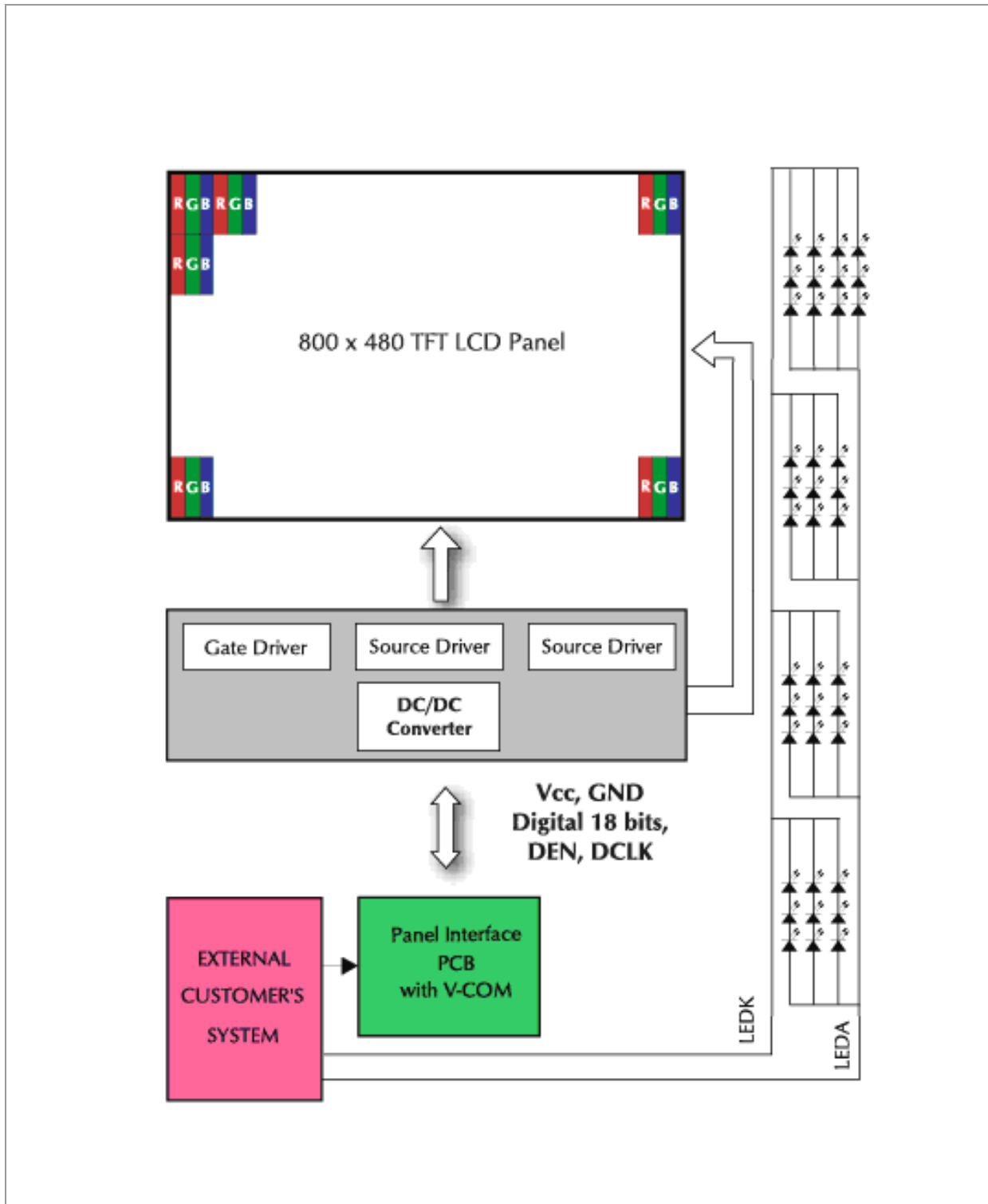

6. Displayed Color and Input Data

	Color & Gray Scale	Data Signal																	
		R5	R4	R3	R2	R1	R0	G5	G4	G3	G2	G1	G0	B5	B4	B3	B2	B1	B0
Basic Color	Black	0	0	0	0	0	0	0	0	0	0	0	0	0	0	0	0	0	0
	Red(0)	1	1	1	1	1	1	0	0	0	0	0	0	0	0	0	0	0	0
	Green(0)	0	0	0	0	0	0	1	1	1	1	1	1	0	0	0	0	0	0
	Blue(0)	0	0	0	0	0	0	0	0	0	0	0	0	1	1	1	1	1	1
	Cyan	0	0	0	0	0	0	1	1	1	1	1	1	1	1	1	1	1	1
	Magenta	1	1	1	1	1	1	0	0	0	0	0	0	1	1	1	1	1	1
	Yellow	1	1	1	1	1	1	1	1	1	1	1	1	0	0	0	0	0	0
White	1	1	1	1	1	1	1	1	1	1	1	1	1	1	1	1	1	1	
Red	Black	0	0	0	0	0	0	0	0	0	0	0	0	0	0	0	0	0	0
	Red(1)	0	0	0	0	0	1	0	0	0	0	0	0	0	0	0	0	0	0
	Red(2)	0	0	0	0	1	0	0	0	0	0	0	0	0	0	0	0	0	0
	:	:	:	:	:	:	:	:	:	:	:	:	:	:	:	:	:	:	:
	Red(31)	0	1	1	1	1	1	0	0	0	0	0	0	0	0	0	0	0	0
	:	:	:	:	:	:	:	:	:	:	:	:	:	:	:	:	:	:	:
	Red(63)	1	1	1	1	1	1	0	0	0	0	0	0	0	0	0	0	0	0
Green	Black	0	0	0	0	0	0	0	0	0	0	0	0	0	0	0	0	0	0
	Green(1)	0	0	0	0	0	0	0	0	0	0	0	1	0	0	0	0	0	0
	Green(2)	0	0	0	0	0	0	0	0	0	0	1	0	0	0	0	0	0	0
	:	:	:	:	:	:	:	:	:	:	:	:	:	:	:	:	:	:	:
	Green(31)	0	0	0	0	0	0	0	1	1	1	1	1	0	0	0	0	0	0
	:	:	:	:	:	:	:	:	:	:	:	:	:	:	:	:	:	:	:
	Green(63)	0	0	0	0	0	0	1	1	1	1	1	1	0	0	0	0	0	0
Blue	Black	0	0	0	0	0	0	0	0	0	0	0	0	0	0	0	0	0	0
	Blue(1)	0	0	0	0	0	0	0	0	0	0	0	0	0	0	0	0	0	1
	Blue(2)	0	0	0	0	0	0	0	0	0	0	0	0	0	0	0	0	1	0
	:	:	:	:	:	:	:	:	:	:	:	:	:	:	:	:	:	:	:
	Blue(31)	0	0	0	0	0	0	0	0	0	0	0	0	0	1	1	1	1	1
	:	:	:	:	:	:	:	:	:	:	:	:	:	:	:	:	:	:	:
	Blue(63)	0	0	0	0	0	0	0	0	0	0	0	0	1	1	1	1	1	1

0 : Low level voltage, 1 :High level voltage

Each basic color can be displayed in 64 gray scales from 6 bit data signals. With the combination of total 18 bit data signals, the 262,144-color display can be achieved on the screen.

7. Reliability Condition

No change on display and in operation under the following test condition.

Condition: Unless otherwise specified, tests will be conducted under the following condition.

Temperature: 20±5°C.

Humidity: 65±5%RH.

Tests will be not conducted under functioning state.

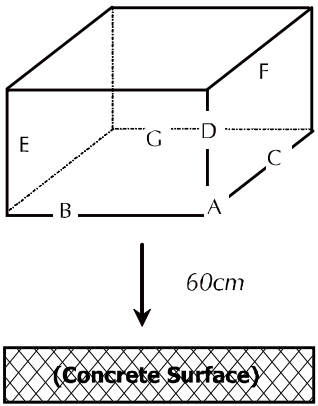
No.	Parameter	Condition	Notes
1	High Temperature Operating	70°C±2°C, 240hrs (Operation state).	
2	Low Temperature Operating	-20°C±2°C, 240hrs (Operation state).	1
3	High Temperature Storage	80°C±2°C, 240hrs.	2
4	Low Temperature Storage	-30°C±2°C, 240hrs.	1,2
5	High Temperature and High Humidity Operation Test	60°C±2°C, 90%, 240hrs.	1,2
6	Vibration Test	Total fixed amplitude: 1.5mm. Vibration Frequency: 10~55Hz. One cycle 60 seconds to 3 direction of X, Y, Z each 15 minutes.	3
7.	Drop Test	To be measured after dropping from 60cm high on the concrete surface in packing state.  <p><i>Dropping method corner dropping:</i></p> <p><i>A corner: Once edge dropping.</i></p> <p><i>B, C, D edge: Once face dropping.</i></p> <p><i>E, F, G face: Once.</i></p>	

- Notes:
1. No dew condensation to be observed.
 2. The function test shall be conducted after 4 hours storage at the normal temperature and humidity after removed from the test chamber.
 3. Vibration test will be conducted to the product itself without putting I in a container.

8. Dimensional Outlines

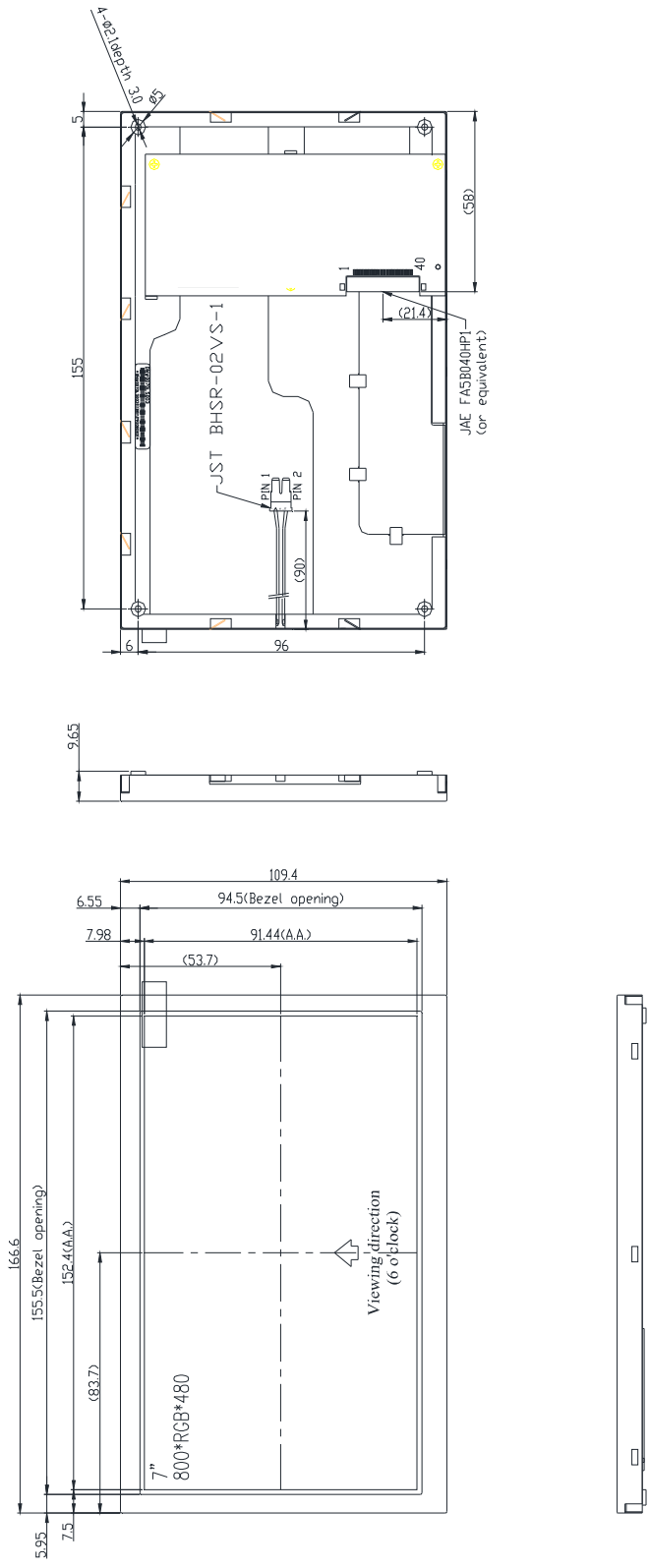

No:	PIN NAME
1	VCC
2	VCC
3	VCC
4	VCC
5	NC
6	DE
7	VSS
8	NC
9	VSS
10	NC
11	VSS
12	B5
13	B4
14	B3
15	VSS
16	B2
17	B1
18	B0
19	VSS
20	G5
21	G4
22	G3
23	VSS
24	G2
25	G1
26	G0
27	VSS
28	R5
29	R4
30	R3
31	VSS
32	R2
33	R1
34	R0
35	NC
36	VSS
37	VSS
38	DCLK
39	VSS
40	VSS

9. Incoming Inspection Standards

9.1 Inspection and Environment Conditions

9.1.1 Inspection Conditions:

- (1) Inspection Distance: 35 cm±5cm
- (2) View Angle : Light-on Inspection Angle : ±5°
Cosmetic Inspection Angle : ±45°

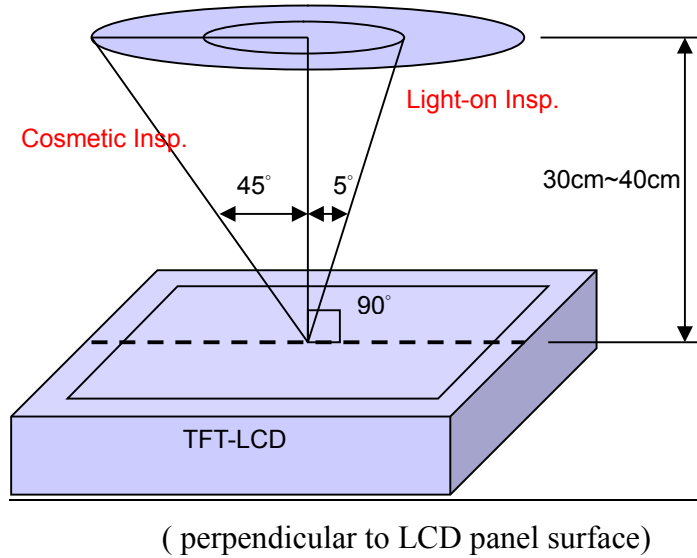

9.1.2 Environment Conditions:

Ambient Temperature		23°C ±5°C
Ambient Humidity		55±10%RH
Ambient Illumination	Cosmetic Inspection	more than 600 Lux
	Functional Inspection	300~500 Lux

9.1.3 Sampling Conditions:

- (1) Lot Size: Quantity of shipment lot per model
- (2) Sampling Method:

Sampling Plan		MIL-STD-105E
		Normal Inspection, Single Sampling
		Level II
AQL	Major Defect	1.0%
	Minor Defect	1.5%

- (3) The classification of Major(MA) and Minor(MI) defects is shown as 3. Inspection Criteria.

9.1.4 Inspection Criteria

9.1.4.1 Cosmetic Inspection (Panel):

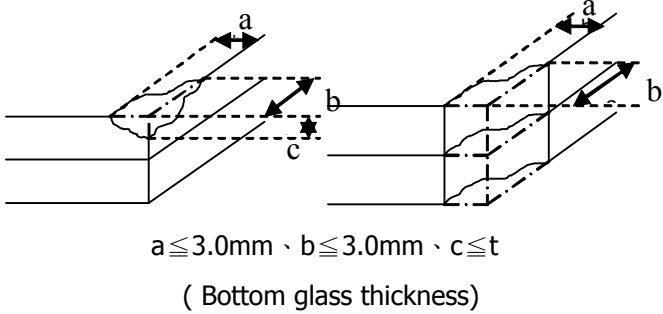
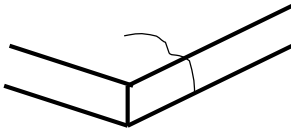
Item	Judgment Criteria	Classification
silicone	That all 3 controller chips (COG IC) have complete fill with silicone over their top surfaces to reduce risk of impact damage.	
Chipping on Panel	 <p>$a \leq 3.0\text{mm}$ · $b \leq 3.0\text{mm}$ · $c \leq t$ (Bottom glass thickness)</p>	MA
Scratch on Panel *Note-2	$W \leq 0.05\text{mm}$ or $L < 5\text{mm}$: Ignored $0.05\text{mm} < W \leq 0.1\text{mm}$ and $L \leq 5\text{mm}$: $N \leq 5$ $W > 0.1\text{mm}$ or $L > 5\text{mm}$: Not allowed	MI
Bubble or Dent on Panel *Note-3	$D \leq 0.2\text{mm}$: Ignored $0.2\text{mm} < D \leq 0.3\text{mm}$: $N \leq 5$ $D > 0.3\text{mm}$: Not allowed	MI
Panel Crack	 <p>Not Allowed crack</p>	MA
Bezel Deformation	Obvious deformation is not allowed.	MI
Bezel Oxidation	Not allowed if it rusts continuously over 1 cm (It is out of warranty with rusted tin plate)	MI
Bezel Scratch	$L \leq 20\text{mm}$, $W \leq 0.2$, $N \leq 3$	MI
Metal Squash Dent /Flange(Front Side)	$D(W) \leq 1, L \leq 3, N \leq 3$;	MI
B/L High Voltage Wire Denudation	Not allowed	MA
Polarizer flaw or leak out resin	Defect is defined as the active area.	MI
Outline Dimension	Must in Spec, refer to related product spec.	MI

9.1.4.2 Functional Inspection:

Item	Judgment Criteria			Classification
	Area(Note1)	I	O	
Point Defect	Bright dot	Random	2	
		2 dots adjacent	0	0
		3 dots adjacent or more	0	0
	Dark dot	Random	3	
		2 dots adjacent	1	
		3 dots adjacent or more	0	0
	Total Dot Defect		5	
	Distance	Distance between Bright and Bright dot	$L \geq 5\text{mm}$	
		Distance between Bright and Dark dot	$L \geq 5\text{mm}$	
		Distance between Dark dot	$L \geq 5\text{mm}$	
(1) It is defined as Point Defect if defect area $> 0.5\text{dot}$ (2) It is ignored if defect area $\leq 0.5\text{dot}$ (3) Weak point defect will be defined as Bright Dot if it can be observed through ND filter 5% (Full Screen Black Inspection)				
Line Defect	Obvious vertical or horizontal line defect is not allowed.			MA
Mura	Not allowed if it can be observed through ND Filter 5 %			MI
Foreign Material in spot shape *Note-3	$D \leq 0.2\text{mm}$: Ignored $0.2\text{mm} < D \leq 0.5\text{mm}$: $N \leq 8$ $D > 0.5\text{mm}$: Not allowed			MI
Foreign Material in line or spiral shape *Note-4	$W \leq 0.05\text{mm}$ or $L \leq 5\text{mm}$: Ignored $0.05\text{mm} < W \leq 0.2\text{mm}$ and $L 1.0\text{mm} \leq 5\text{mm}$: $N \leq 8$ $W > 0.2\text{mm}$ or $L > 5\text{mm}$: Not allowed			MI
Display Function Abnormal	No Malfunction can be allowed			MA

Note-1 : I/O Area Definition

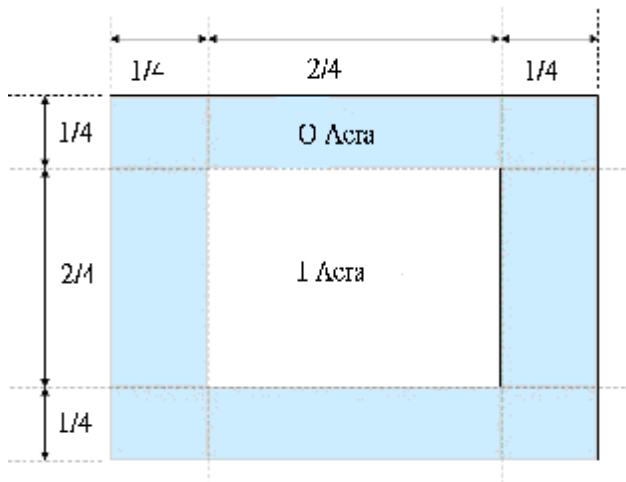

Note-2 : Polarizer Scratch

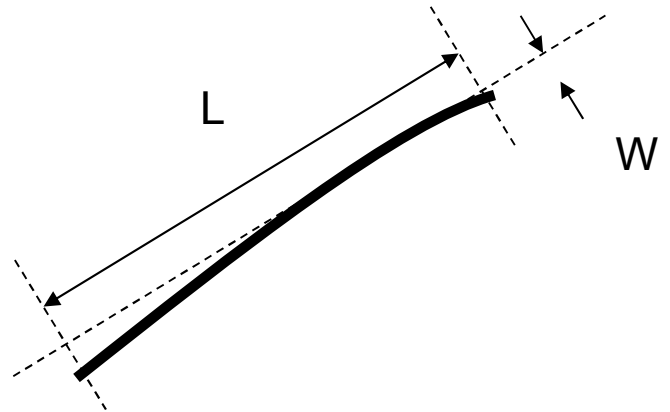

Note-3 : Spot Foreign Material
($W \geq L / 4$)

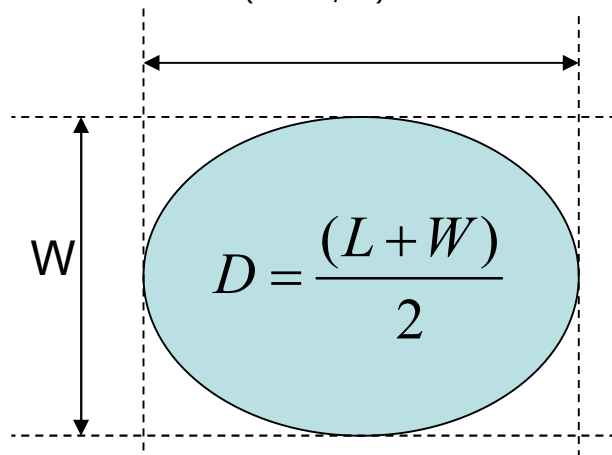

Note-4 : Line or Spiral Foreign Material
($W < L / 4$)

