

DISPLAY Elektronik GmbH

DATA SHEET

LCD MODULE

DEM 16207 SBH-PW-N

Product Specification

Version: 4

01.09.2017

GENERAL SPECIFICATION

MODULE NO. :

DEM 16207 SBH-PW-N

CUSTOMER P/N

Version NO.	Change Description	Date
0	Specification Released	07.02.2013
1	Revised Optical Characteristics	21.02.2013
1.0	Change Production Line	12.05.2017
1.1	Update the dimension 4.35mm in page 4 and adding chapter 18/19/20	15.05.2017
2	Update LCD drawing/Update BL Luminance	23.05.2017
3	Delete the dimension 2.67 on page 4; Update the block diagram on page 5; Update definition of characteristics on page 11-16	01.06.2017
4	Change Dimension	01.09.2017

PREPARED BY: HZ

DATE: 01.09.2017

APPROVED BY: MHO

DATE: 01.09.2017

CONTENTS

1. FUNCTIONS &FEATURES.....2

2. MECHANICAL SPECIFICATIONS2

3. EXTERNAL DIMENSIONS (Unit: mm)3

4. BLOCK DIAGRAM4

5. PIN ASSIGNMENT4

6. BACKLIGHT ELECTRICAL/OPTICAL SPECIFICATIONS.....5

7. ABSOLUTE MAXIMUM RATINGS6

8. ELECTRICAL CHARACTERISTICS6

9. INSTRUCTION8

10. STANDARD CHARACTER PATTERN (ST7032i-0D).....9

11. LCD ELECTRICAL& OPTICAL CHARACTERISTICS.....10

12. LCD ARTWORK13

13. SEG LAYOUT13

14. COM LAYOUT.....14

15. IC LAYOUT.....14

16. ACCEPT QUALITY LEVEL (AQL).....15

17. RELIABILITY TEST15

18. LCD MODULES HANDLING PRECAUTIONS17

19. OTHERS17

1. FUNCTIONS &FEATURES

MODULE NAME	LCD Type
DEM 16207 SBH-PW-N	STN BLUE Transmissive Negative Mode

- Viewing Direction : 6 O'clock
- Driving Scheme : 1/16 Duty, 1/5 Bias
- Supply Voltage : 4.2 Volt (typ.)
- Vop Adjustable For Best Contrast : 4.2 Volt (typ.)
- Driver IC : ST7032i (Sitronix)
- Interface : I²C
- RoHS Compliant

2. MECHANICAL SPECIFICATIONS

- Module Size (without FPC) : 59.00 x 26.00 x 4.35 mm
- Viewing Area : 50.00 x 16.00 mm
- Active Area : 46.70 x 10.00 mm

3. EXTERNAL DIMENSIONS (Unit: mm)

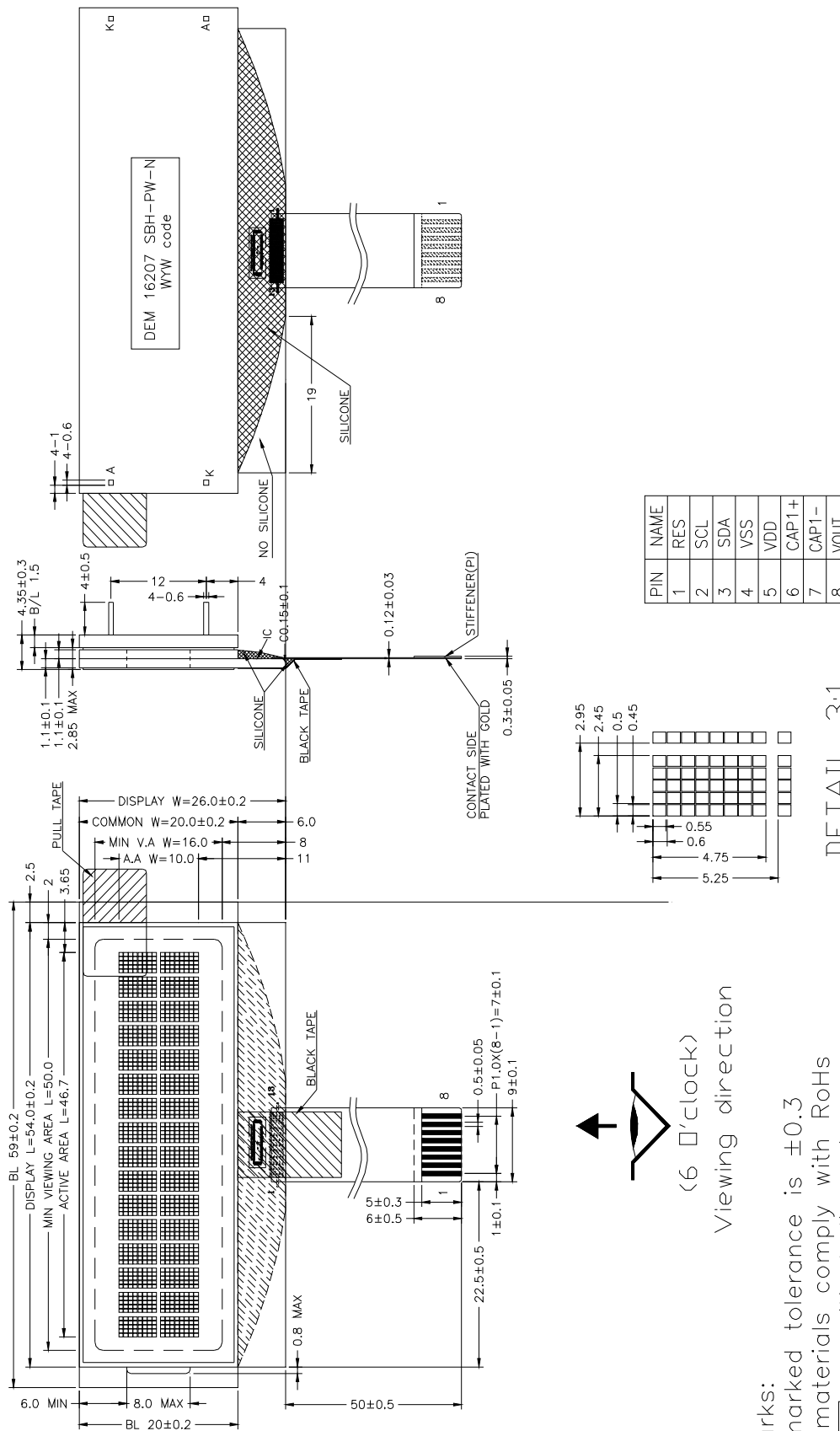

PIN	NAME
1	RES
2	SCL
3	SDA
4	VSS
5	VDD
6	CAP1+
7	CAP1-
8	VOUT

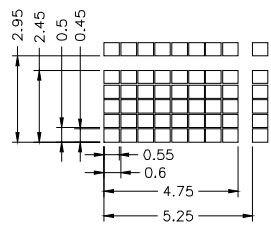

DETAIL 3:1

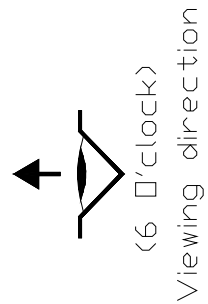

- Remarks:
1. Unmarked tolerance is ± 0.3
 2. All materials comply with RoHs
 3. ...:critical dimension.

4. BLOCK DIAGRAM

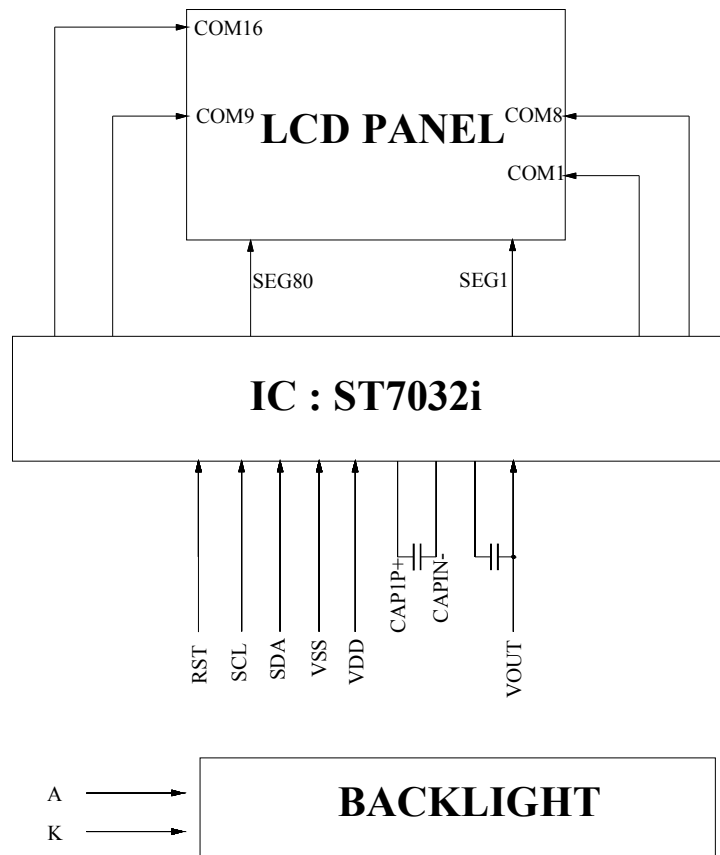

5. PIN ASSIGNMENT

Pin No.	Name	Description
1	RST	Reset Signal Input(Active Low)
2	SCL	Serial Clock Input
3	SDA	Serial Data I/O
4	VSS	Ground.
5	VDD	Power Supply
6	CAP1+	For voltage booster circuit (VDD-VSS)
7	CAP1-	External capacitor about 0.1uF~4.7uF
8	VOUT	DC/DC voltage converter. Connect a capacity between this terminal and VDD when the built-in booster is used.

6. BACKLIGHT ELECTRICAL/OPTICAL SPECIFICATIONS

Electrical/Optical Characteristic

ELECTRICAL–OPTICAL CHARACTERISTICS

Item	Symbol	min.	typ.	max.	Unit	Condition
Forward Voltage	Vf	3.0	3.2	3.4	V	If= 60*2 mA
Power Dissipation	Pd	360	384	408	mW	If= 60*2 mA
Luminous Uniformity	ΔL_v	70			%	MIN/MAX*100%
Luminance	Lv		3800		cd/m ²	If= 60*2 mA T=25°C
Color Coordinate	X	0.23		0.34		
	Y	0.23		0.34		

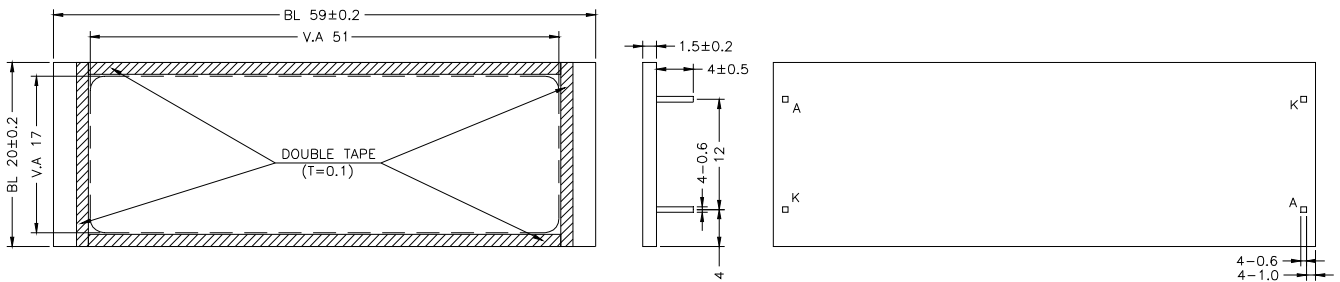

Remarks:

- 1.Unmarked tolerance is ± 0.3
- 2.All materials comply with Rohs
3. ...:critical dimension.
- 4.Operation temperature: -20°C to $+70^{\circ}\text{C}$
Storage temperature: -30°C to $+80^{\circ}\text{C}$

Circuit Diagram
Color:White

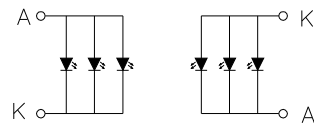

7. ABSOLUTE MAXIMUM RATINGS

Characteristic	Symbol	Value	Unit
Power Supply Voltage	VDD	-0.3 to+6.0	V
LCD Driver Voltage	Vop	7.0 - V _{SS} to -0.3 + V _{SS}	V
Input Voltage	V _{IN}	-0.3 to V _{DD} +0.3	V
Operating Temperature	Topr	-20 to +70	□
Storage Temperature	Tstg	-30 to +80	□

8. ELECTRICAL CHARACTERISTICS**8.1 DC CHARACTERISTICS**

Parameter	Symbol	Min.	Typ.	Max.	Unit
Supply Voltage	VDD	3.9	4.2	4.5	V
LCD Supply Voltage	Vop	3.9	4.2	4.5	V
Supply Current	I _{DD}	---	TBD	---	mA

8-2. AC Characteristics

Item	Signal	Symbol	Condition	VDD=2.7 to 4.5V Rating		VDD=4.5 to 5.5V Rating		Units
				Min.	Max.	Min.	Max.	
SCL clock frequency	SCL	f_{SCLK}	—	DC	400	DC	400	KHz
SCL clock low period		t_{LOW}		1.3	—	1.3	—	
SCL clock high period		t_{HIGH}		0.6	—	0.6	—	
Data set-up time	SI	$t_{SU;DAT}$	—	180	—	100	—	ns
Data hold time		$t_{HD;DAT}$		0	0.9	0	0.9	
SCL,SDA rise time	SCL, SDA	t_r	—	$20+0.1C_b$	300	$20+0.1C_b$	300	ns
SCL,SDA fall time		t_f		$20+0.1C_b$	300	$20+0.1C_b$	300	
Capacitive load represent by each bus line		C_b	—	—	400	—	400	pf
Setup time for a repeated START condition	SI	$t_{SU;STA}$	—	0.6	—	0.6	—	us
Start condition hold time		$t_{HD;STA}$	—	0.6	—	0.6	—	
Setup time for STOP condition		$t_{SU;STO}$	—	0.6	—	0.6	—	us
Bus free time between a Stop and START condition	SCL	t_{BUF}	—	1.3	—	1.3	—	us

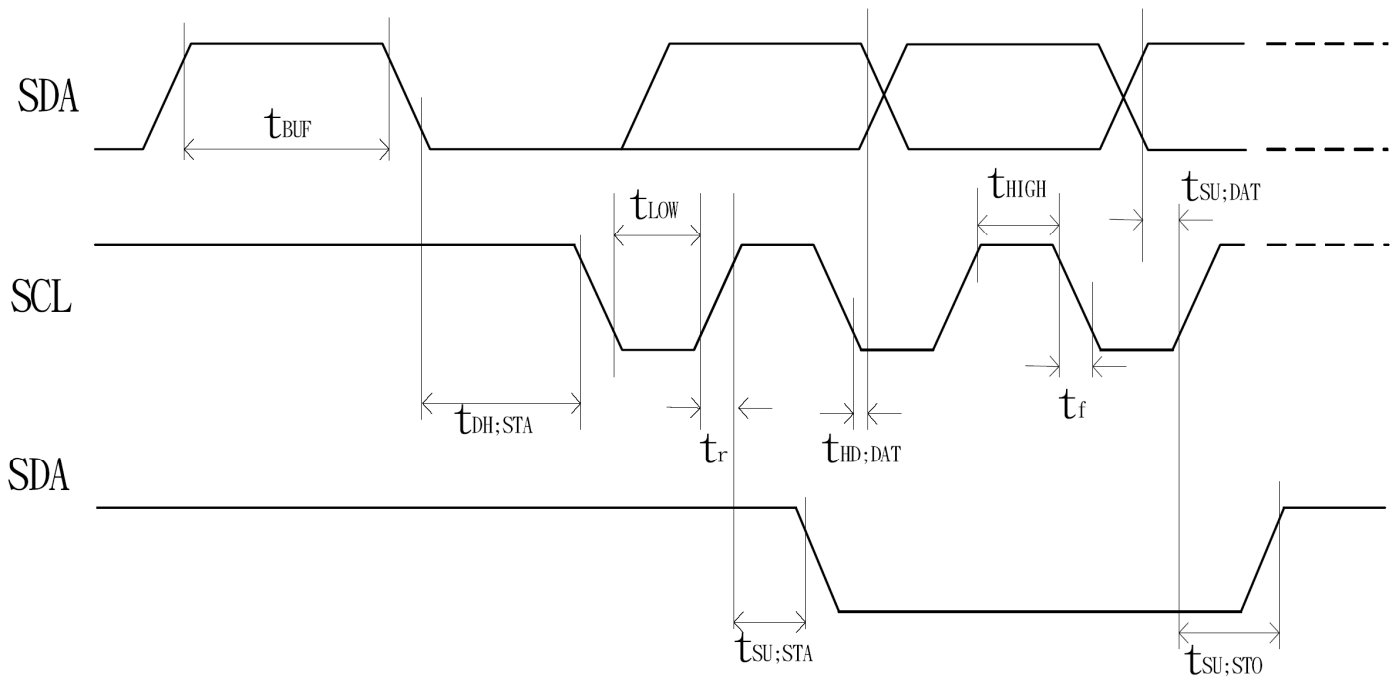

9. INSTRUCTION

Instruction	Instruction Code										Description	Instruction Execution Time		
	RS	R/W	DB7	DB6	DB5	DB4	DB3	DB2	DB1	DB0		OSC=380KHz	OSC=540KHz	OSC=700KHz
Clear Display	0	0	0	0	0	0	0	0	0	1	Write "20H" to DDRAM. and set DDRAM address to "00H" from AC	1.08 ms	0.76 ms	0.59 ms
Return Home	0	0	0	0	0	0	0	0	1	x	Set DDRAM address to "00H" from AC and return cursor to its original position if shifted. The contents of DDRAM are not changed.	1.08 ms	0.76 ms	0.59 ms
Entry Mode Set	0	0	0	0	0	0	0	1	I/D	S	Sets cursor move direction and specifies display shift. These operations are performed during data write and read.	26.3 us	18.5 us	14.3 us
Display ON/OFF	0	0	0	0	0	0	1	D	C	B	D=1:entire display on C=1:cursor on B=1:cursor position on	26.3 us	18.5 us	14.3 us
Function Set	0	0	0	0	1	DL	N	DH	*0	IS	DL: interface data is 8/4 bits N: number of line is 2/1 DH: double height font IS: instruction table select	26.3 us	18.5 us	14.3 us
Set DDRAM address	0	0	1	AC6	AC5	AC4	AC3	AC2	AC1	AC0	Set DDRAM address in address counter	26.3 us	18.5 us	14.3 us
Read Busy flag and address	0	1	BF	AC6	AC5	AC4	AC3	AC2	AC1	AC0	Whether during internal operation or not can be known by reading BF. The contents of address counter can also be read.	0	0	0
Write data to RAM	1	0	D7	D6	D5	D4	D3	D2	D1	D0	Write data into internal RAM (DDRAM/CGRAM/ICONRAM)	26.3 us	18.5 us	14.3 us
Read data from RAM	1	1	D7	D6	D5	D4	D3	D2	D1	D0	Read data from internal RAM (DDRAM/CGRAM/ICONRAM)	26.3 us	18.5 us	14.3 us

Note * : this bit is for test command , and must always set to "0"

Instruction table 0(IS=0)														
Cursor or Display Shift	0	0	0	0	0	1	S/C	R/L	x	x	S/C and R/L: Set cursor moving and display shift control bit, and the direction, without changing DDRAM data.	26.3 us	18.5 us	14.3 us
Set CGRAM	0	0	0	1	AC5	AC4	AC3	AC2	AC1	AC0	Set CGRAM address in address counter	26.3 us	18.5 us	14.3 us

Instruction table 1(IS=1)														
Internal OSC frequency	0	0	0	0	0	1	BS	F2	F1	F0	BS=1:1/4 bias BS=0:1/5 bias F2~0: adjust internal OSC frequency for FR frequency.	26.3 us	18.5 us	14.3 us
Set ICON address	0	0	0	1	0	0	AC3	AC2	AC1	AC0	Set ICON address in address counter.	26.3 us	18.5 us	14.3 us
Power/ICON control/Contrast set	0	0	0	1	0	1	Ion	Bon	C5	C4	Ion: ICON display on/off Bon: set booster circuit on/off C5,C4: Contrast set for internal follower mode.	26.3 us	18.5 us	14.3 us
Follower control	0	0	0	1	1	0	Fon	Rab2	Rab1	Rab0	Fon: set follower circuit on/off Rab2~0: select follower amplified ratio.	26.3 us	18.5 us	14.3 us
Contrast set	0	0	0	1	1	1	C3	C2	C1	C0	Contrast set for internal follower mode.	26.3 us	18.5 us	14.3 us

10. STANDARD CHARACTER PATTERN (ST7032i-0D)

ST7032-0D (ITO option OPR1=0, OPR2=0)

b7-b4 b0-b0	0000	0001	0010	0011	0100	0101	0110	0111	1000	1001	1010	1011	1100	1101	1110	1111	
0000	Replaced By CGRAM Pattern	☐	☐	☐	☐	☐	☐	☐	☐	☐	☐	☐	☐	☐	☐	☐	
0001		☐	☐	☐	☐	☐	☐	☐	☐	☐	☐	☐	☐	☐	☐	☐	☐
0010		☐	☐	☐	☐	☐	☐	☐	☐	☐	☐	☐	☐	☐	☐	☐	☐
0011		☐	☐	☐	☐	☐	☐	☐	☐	☐	☐	☐	☐	☐	☐	☐	☐
0100		☐	☐	☐	☐	☐	☐	☐	☐	☐	☐	☐	☐	☐	☐	☐	☐
0101		☐	☐	☐	☐	☐	☐	☐	☐	☐	☐	☐	☐	☐	☐	☐	☐
0110		☐	☐	☐	☐	☐	☐	☐	☐	☐	☐	☐	☐	☐	☐	☐	☐
0111		☐	☐	☐	☐	☐	☐	☐	☐	☐	☐	☐	☐	☐	☐	☐	☐
1000	Replaced By CGRAM Pattern	☐	☐	☐	☐	☐	☐	☐	☐	☐	☐	☐	☐	☐	☐	☐	
1001		☐	☐	☐	☐	☐	☐	☐	☐	☐	☐	☐	☐	☐	☐	☐	☐
1010		☐	☐	☐	☐	☐	☐	☐	☐	☐	☐	☐	☐	☐	☐	☐	☐
1011		☐	☐	☐	☐	☐	☐	☐	☐	☐	☐	☐	☐	☐	☐	☐	☐
1100		☐	☐	☐	☐	☐	☐	☐	☐	☐	☐	☐	☐	☐	☐	☐	☐
1101		☐	☐	☐	☐	☐	☐	☐	☐	☐	☐	☐	☐	☐	☐	☐	☐
1110		☐	☐	☐	☐	☐	☐	☐	☐	☐	☐	☐	☐	☐	☐	☐	☐
1111		☐	☐	☐	☐	☐	☐	☐	☐	☐	☐	☐	☐	☐	☐	☐	☐

11. LCD ELECTRICAL & OPTICAL CHARACTERISTICS

Ta=25°C

Item	Symbol	Description	Condition	Min.	Typ.	Max.	Unit
Contrast	Cr		$\theta=5^\circ, \Phi=0^\circ$	3.0			
Viewing Angle	$\theta 2-\theta 1$	6o'clock axis	$Cr \geq 2.0 \Phi=0^\circ$	30			°
Response Time	T_r	Rise	$\theta=5^\circ, \Phi=0^\circ$	---	---	240	ms
	T_f	Fall	$\theta=5^\circ, \Phi=0^\circ$	---	---	220	

11.1 Definition of Characteristics.

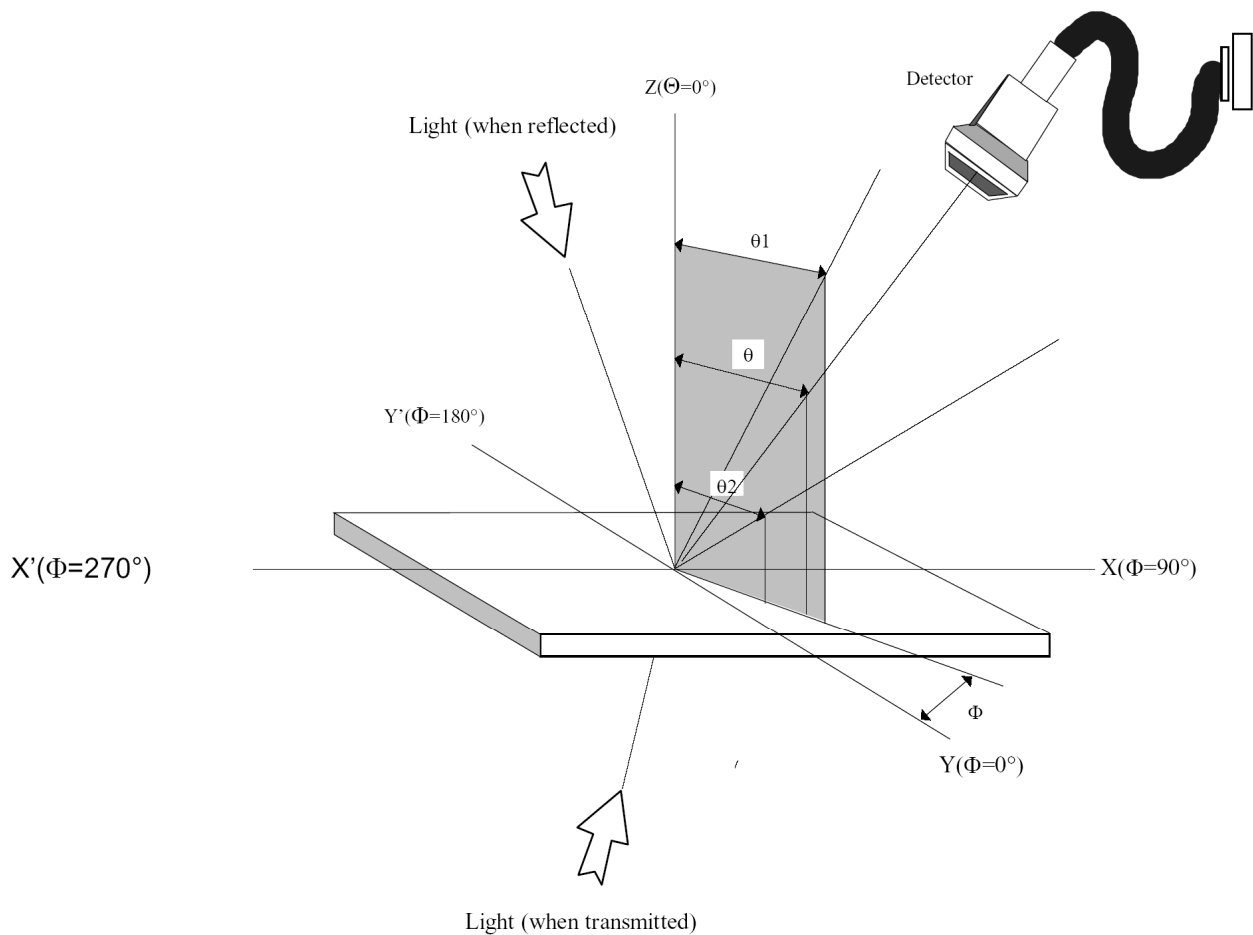

Definition of contrast

$$Cr. = \frac{B1}{B2} = \frac{\text{Brightness of not selected segment}}{\text{Brightness of selected segment}}$$

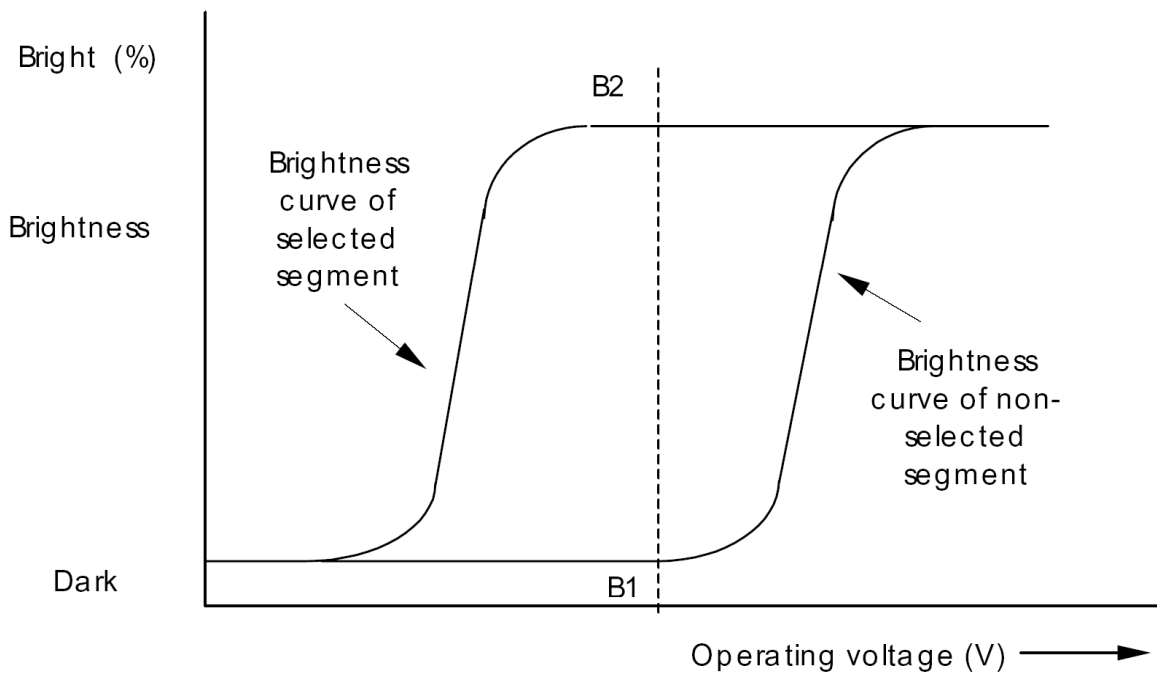

11.2. Definition of Viewing Angle

Definition of viewing angle θ_1 and θ_2

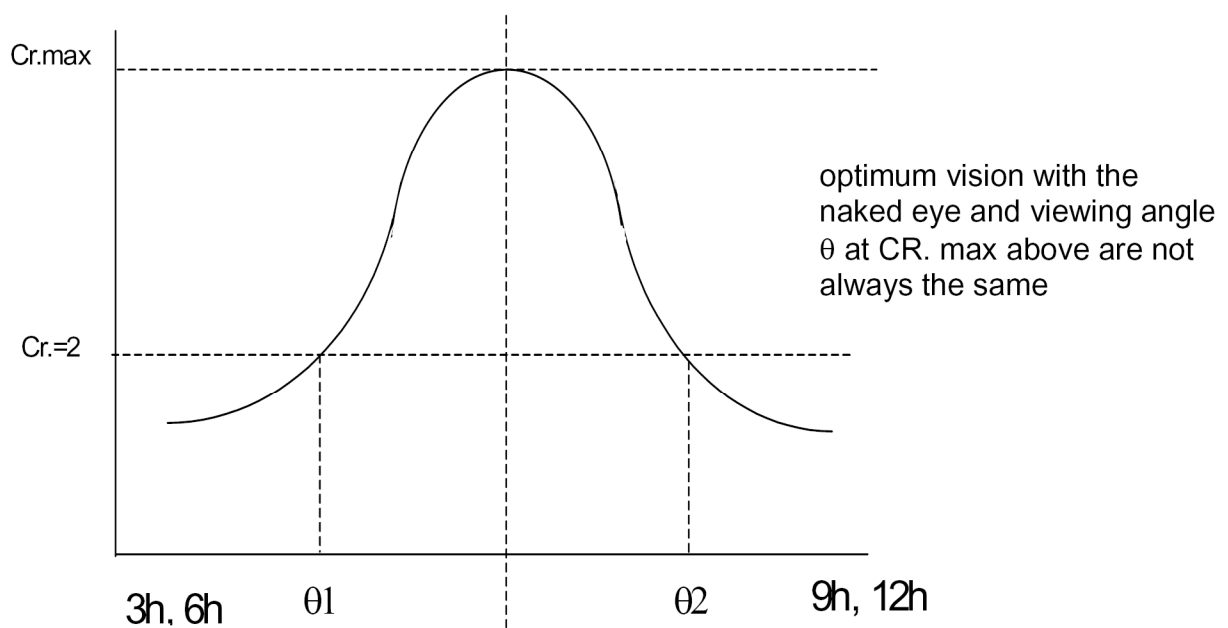

11.3 Definition of Response Time

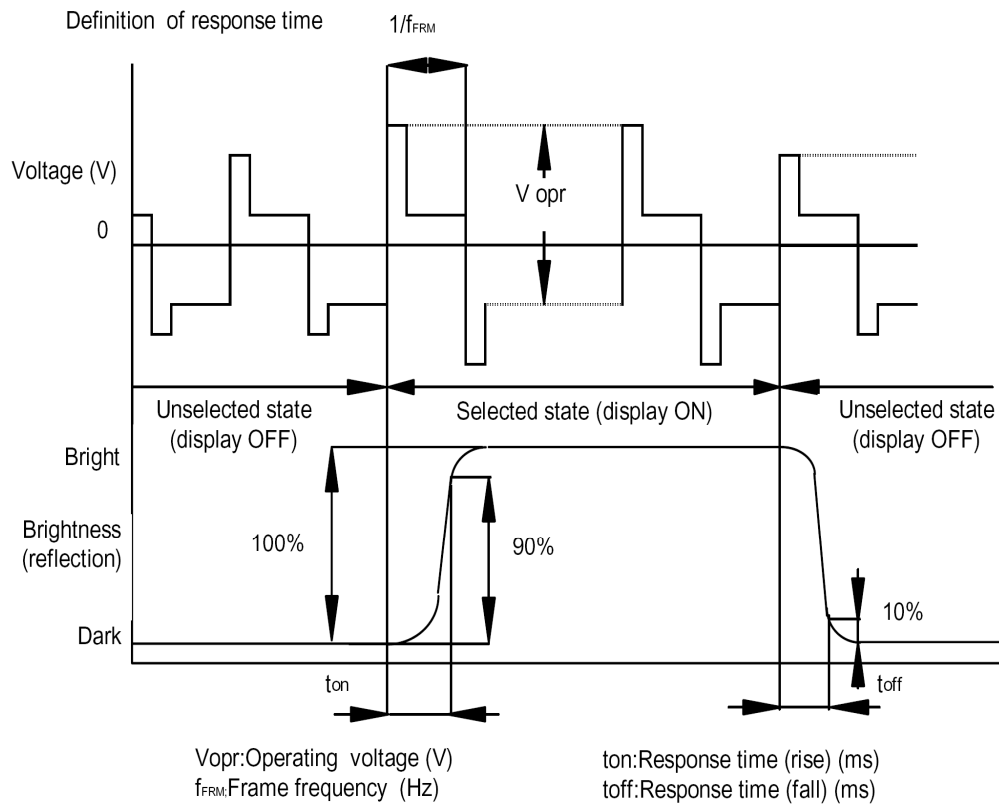

12. LCD ARTWORK

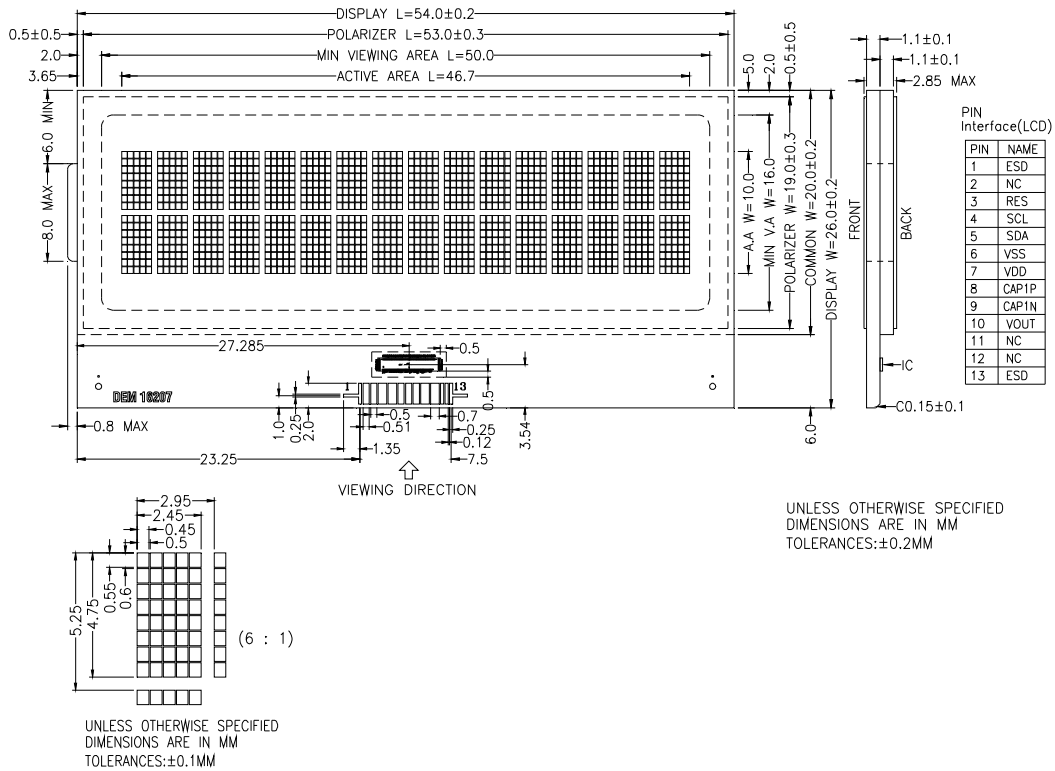

13. SEG LAYOUT

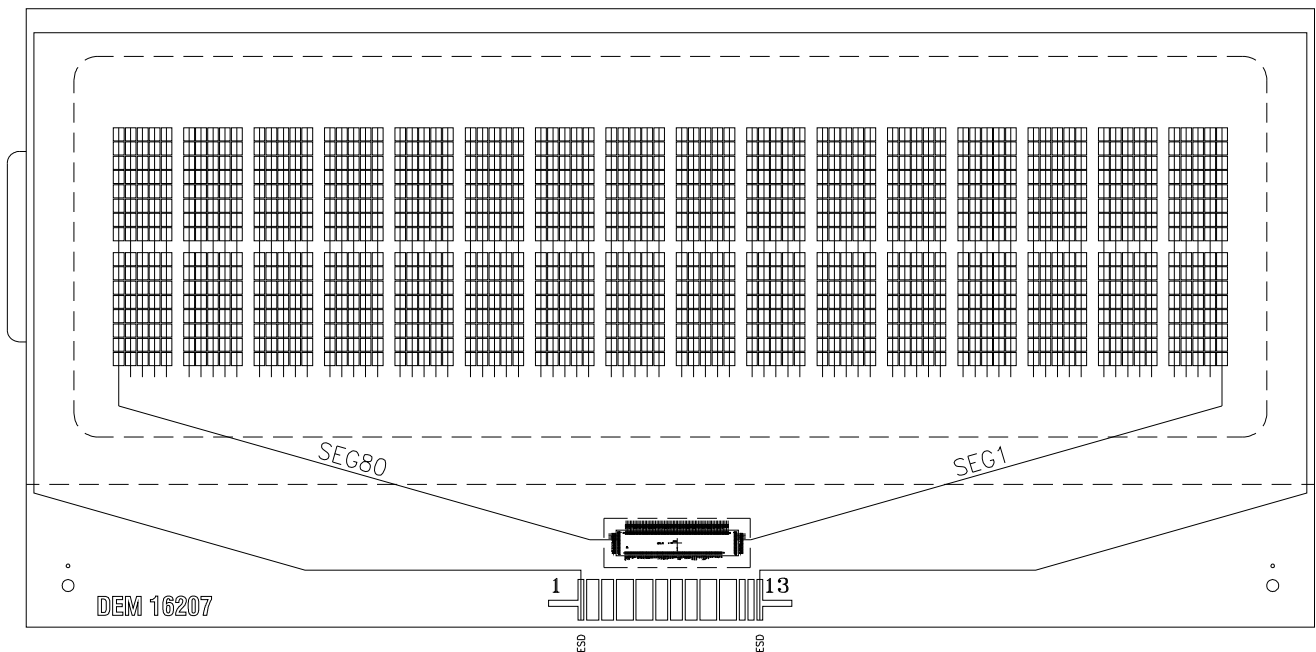

14. COM LAYOUT

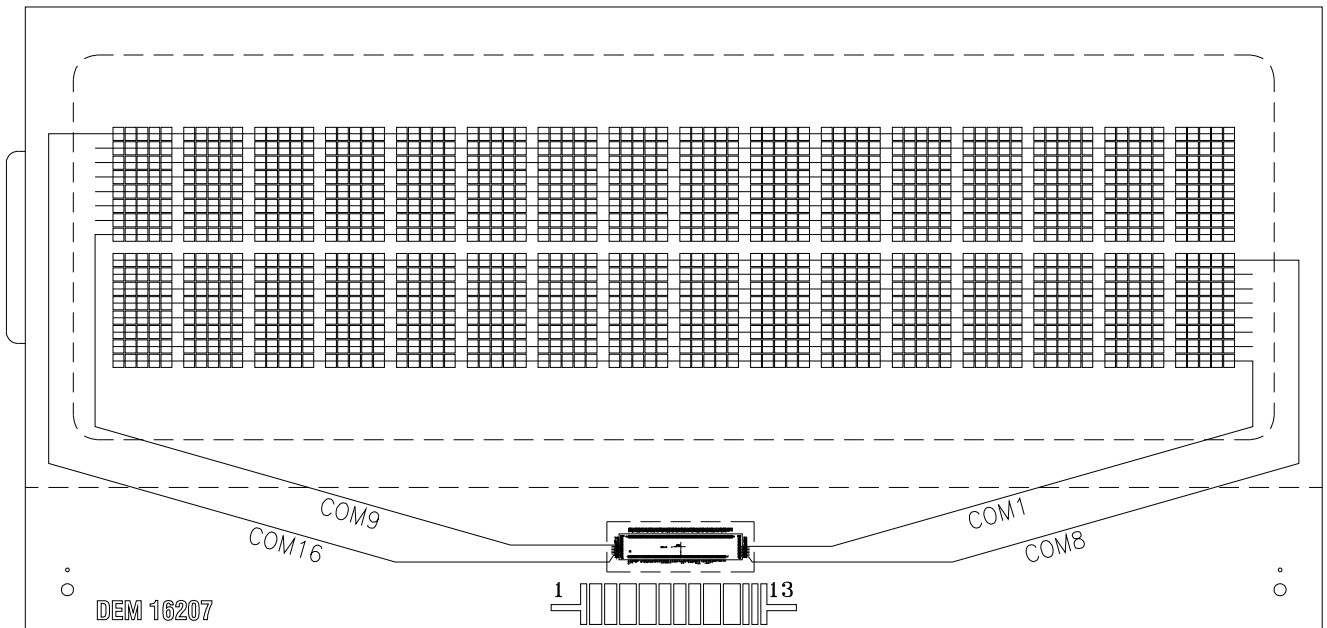

15. IC LAYOUT

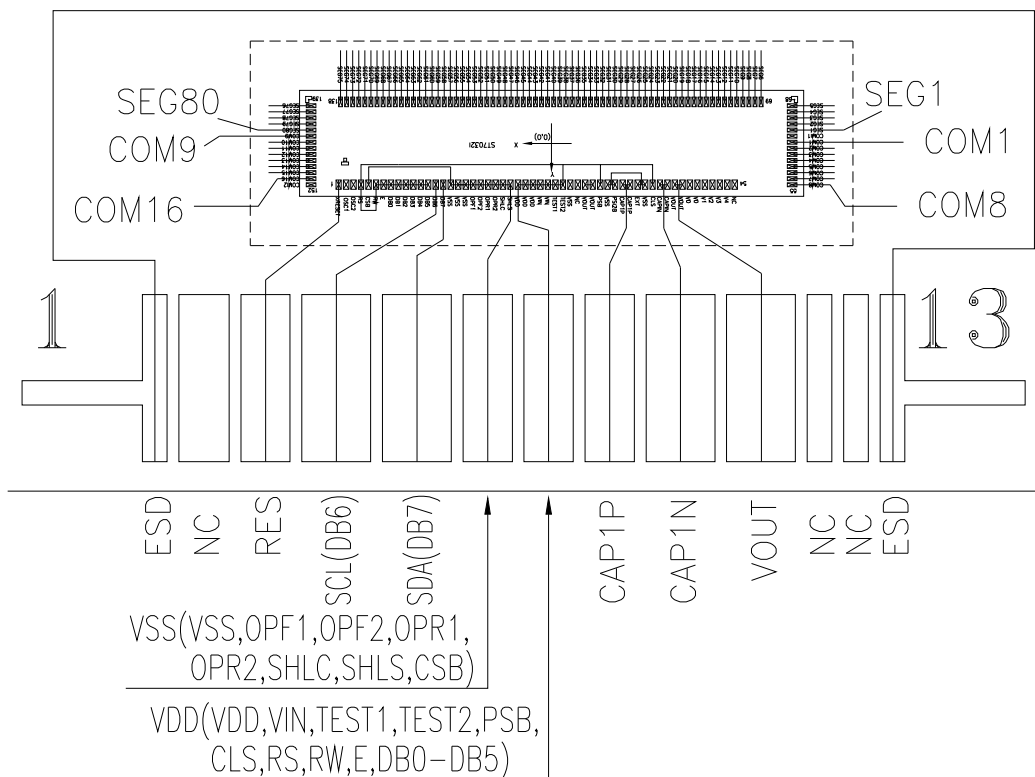

16. ACCEPT QUALITY LEVEL (AQL)

AQL Standard Value: Critical Defect =0.1, Major Defect=0.65; Minor Defect =2.5.

17. RELIABILITY TEST

Operating life time: 50000 hours (at room temperature without direct irradiation of sunlight)

Reliability characteristics shall meet following requirements.

Test Item	Test Condition
High temperature storage	+80□ x 96hrs
Low temperature storage	-30□ x 96hrs
High temperature operation	+70□ x 96hrs
Low temperature operation	-20□ x 96hrs
High temperature, High humidity (storage)	+60□ x 90%RH x 96hrs
Thermal shock	-20□ x 30min → +25□ x 10s → +70□ x 30min 5Cycles
Vibration test	Frequency x Swing x Time 40Hz x 4mm x 4hrs
Drop test	Drop Height x No. of drops 1.0m x 6 drops

18. QUALITY DESCRIPTION

DEFECT SPECIFICATION:

a: Table for Cosmetic defects
 (Note: nc = not counted).
 Sizes and number of defects
 (Max. Qty)

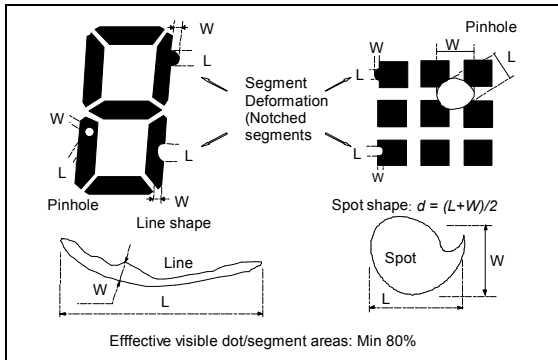

Examples/ Shapes

b: Glass defects
 b1: Glass defects at contact ledge

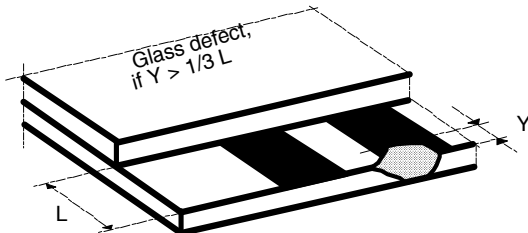

b2: Glass chipping in other areas shall not be in conflict with the product's function.

Defect Type	Max. defect size [μm] d or L W	Max. Quantity
Black or White Spots	$d \leq 150$	nc
	$150 < d \leq 200$	3
Black or White Lines	-- $W \leq 10$	nc
	$L \leq 3000$ $W \leq 30$	2
	$L \leq 2000$ $W \leq 50$	2
Pinhole	$d \leq 150$ $150 < d \leq 300$	nc 1/segment
(Total defects)		(5)
Segment Deformation	$W \leq 100$	nc
Bubble (e.g. under pola)	$d \leq 150$	nc
	$200 < d \leq 400$	2

19. LCD MODULES HANDLING PRECAUTIONS

- Please remove the protection foil of polarizer before using.
- The display panel is made of glass. Do not subject it to a mechanical shock by dropping it from a high place, etc.
- If the display panel is damaged and the liquid crystal substance inside it leaks out, do not get any in your mouth. If the substance come into contact with your skin or clothes promptly wash it off using soap and water.
- Do not apply excessive force to the display surface or the adjoining areas since this may cause the color tone to vary.
- The polarizer covering the display surface of the LCD module is soft and easily scratched. Handle this polarize carefully.
- To prevent destruction of the elements by static electricity, be careful to maintain an optimum work environment.
 - Be sure to ground the body when handling the LCD module.
 - Tools required for assembly, such as soldering irons, must be properly grounded.
 - To reduce the amount of static electricity generated, do not conduct assembly and other work under dry conditions.
 - The LCD module is coated with a film to protect the display surface. Exercise care when peeling off this protective film since static electricity may be generated.
- Storage precautions
When storing the LCD modules, avoid exposure to direct sunlight or to the light of fluorescent lamps. Keep the modules in bags designed to prevent static electricity charging under low temperature / normal humidity conditions (avoid high temperature / high humidity and low temperatures below 0□). Whenever possible, the LCD modules should be stored in the same conditions in which they were shipped from our company.

20. OTHERS

- Liquid crystals solidify at low temperature (below the storage temperature range) leading to defective orientation of liquid crystal or the generation of air bubbles (black or white). Air bubbles may also be generated if the module is subjected to a strong shock at a low temperature.
- If the LCD modules have been operating for a long time showing the same display patterns may remain on the screen as ghost images and a slight contrast irregularity may also appear. Abnormal operating status can be resumed to be normal condition by suspending use for some time. It should be noted that this phenomena does not adversely affect performance reliability.
- To minimize the performance degradation of the LCD modules resulting from caused by static electricity, etc. exercise care to avoid holding the following sections when handling the modules:
 - Exposed area of the printed circuit board
 - Terminal electrode sections