

# USB to Bluetooth KM Switch

---

USER MANUAL

**CS533**

## **FCC INFORMATION**

This equipment has been tested and found to comply with the limits for a Class B digital device, pursuant to Part 15 of the FCC Rules. These limits are designed to provide reasonable protection against harmful interference in a residential installation. This equipment generates, uses and can radiate radio frequency energy, and if not installed and used in accordance with the instruction manual, may cause interference to radio communications. However, there is no guarantee that interference will not occur in a particular installation. If this equipment does cause harmful interference to radio or television reception, which can be determined by turning the equipment off and on, the user is encouraged to try to correct the interference by one or more of the following measures:

- ◆ Reorient or relocate the receiving antenna;
- ◆ Increase the separation between the equipment and receiver;
- ◆ Connect the equipment into an outlet on a circuit different from that which the receiver is connected;
- ◆ Consult the dealer or an experienced radio/television technician for help.

You are cautioned that changes or modifications not expressly approved by the party responsible for compliance could void your authority to operate the equipment.

This device complies with Part 15 of the FCC Rules. Operation is subject to the following two conditions: (1) this device may not cause harmful interference and (2) this device must accept any interference received, including interference that may cause undesired operation.

FCC ID: JYX-CS533

## **RoHS**

This product is RoHS compliant.



## SJ/T 11364-2006

The following contains information that relates to China.

部件名称	有毒有害物质或元素					
	铅	汞	镉	六价铬	多溴联苯	多溴二苯醚
电器部件	●	○	○	○	○	○
机构部件	○	○	○	○	○	○

○: 表示该有毒有害物质在该部件所有均质材料中的含量均在SJ/T 11363-2006规定的限量要求之下。

●: 表示符合欧盟的豁免条款, 但该有毒有害物质至少在该部件的某一均质材料中的含量超出SJ/T 11363-2006的限量要求。

×: 表示该有毒有害物质至少在该部件的某一均质材料中的含量超出SJ/T 11363-2006的限量要求。

# CS533 USER MANUAL

## ONLINE REGISTRATION

International	<a href="http://support.aten.com">http://support.aten.com</a>
North America	<a href="http://www.aten-usa.com/product_registration">http://www.aten-usa.com/product_registration</a>

## TELEPHONE SUPPORT

International	886-2-8692-6959
China	86-10-5255-0110
Japan	81-3-5615-5811
Korea	82-2-467-6789
North America	1-888-999-ATEN ext 4988
United Kingdom	44-8448-158923

## TECHNICAL SUPPORT

- ◆ For international online technical support – including troubleshooting, documentation, and software updates:  
**<http://support.aten.com>**
- ◆ For North American technical support:

Email Support		<a href="mailto:support@aten-usa.com">support@aten-usa.com</a>
Online Technical Support	Troubleshooting Documentation Software Updates	<a href="http://www.aten-usa.com/support">http://www.aten-usa.com/support</a>
Telephone Support		1-888-999-ATEN ext 4998

## PACKAGE CONTENTS

The CS533 Tap package contains the following items:

- ◆ 1 CS533 Tap
- ◆ 1 User Instructions\*

Check to make sure that all the components are present and that nothing got damaged in shipping. If you encounter a problem, contact your dealer.

Read this manual thoroughly and follow the installation and operation procedures carefully to prevent any damage to the unit, and/or any of the devices connected to it.

---

\* Features may have been added to the CS533 since this manual was published. Please visit our website to download the most up-to-date version of the manual.

---

Copyright © 2012 ATEN® International Co., Ltd.  
Manual Date: 2012-06-19

ATEN and the ATEN logo are trademarks of ATEN International Co., Ltd. All rights reserved. All other trademarks are the property of their respective owners.

## OVERVIEW

The CS533 Tap is a control unit that allows access to one computer and two Bluetooth devices from a USB keyboard and mouse. The CS533 eliminates the need to purchase a Bluetooth keyboard or mouse for your mobile device, saving you valuable work space, allowing you to use your favorite multimedia keyboard with all your Bluetooth devices.

The CS533 Tap converts normal USB keyboard and mouse signals into Bluetooth connections to allow for easy sharing between your computer and mobile devices. The CS533 has a compact design and provides a convenient hotkey share method to switch quickly between a computer and two Bluetooth devices.

Setup is simple; plug a USB keyboard and mouse into the CS533 rear ports, connect the CS533 to your computer, sync your Bluetooth devices with the CS533, then use the hotkeys to switch USB keyboard and mouse use between your devices.

## FEATURES

- ◆ Links use of a USB keyboard and mouse\* between a PC and 2 Bluetooth devices
- ◆ Quick switch access to the computer and two Bluetooth devices via hotkey
- ◆ Supports PC and Mac iOS Bluetooth media key mapping
- ◆ Supports wireless and multifunction keyboards
- ◆ Mac keyboard support and emulation\*
- ◆ Supports USB hot-plugging
- ◆ Supports: Windows 2000, XP, Vista, 7, Mac and Linux
- ◆ USB powered
- ◆ No software required

\*Use of a USB mouse on any Bluetooth device depends on the devices hardware manufacturer

\*PC keyboard combinations emulate Mac keyboards.

\*Mac keyboards only work with their own computers.

## **REQUIREMENTS**

### **KEYBOARD/MOUSE**

- ◆ 1 USB Keyboard
- ◆ 1 USB Mouse

\*The CS533 will not work with Bluetooth keyboard or mouse devices

### **COMPUTER**

- ◆ Type A USB Port

### **DEVICES**

- ◆ Up to 2 Bluetooth HID devices

\*USB Mouse will not function on iOS devices and some Bluetooth devices.

### **USB POWER ADAPTER (OPTIONAL)**

- ◆ The CS533 is powered by the computers USB port connection. USB Power Adapters may be used, but must be purchased separately from a local dealer.



## SUPPORTED DEVICES

Below is a table of HID devices\* that support Bluetooth Human Interface Device Profiles (HID) for keyboard use. HID devices support Bluetooth Human Interface Device Profiles (HID) and will work with the CS533.

Supported HID Devices		
Brand	Product	O.S. Version
ACER	A500 / A501 / A100	Android 3.x / 4.x
ASUS	Transformer TF101, Prime TF201	
Motorola	XOOM	
LG	Optimus Pad	
Sony	Tablet S	
Toshiba	AT100	
Samsung	Galaxy Tab 8.9/10.1, Galaxy Nexus, Galaxy Tab P1000	Android 2.x / 4.x
HTC	Sensation, Sensation XE, Flyer, EVO 3D, One X	
Apple	iPad 1 / 2	iOS 4.2.1 and higher
	iPhone 3GS and higher	
	iPod Touch 2nd/3rd/4th Generation	
	MacBook Air/Pro, Mac Pro, Mac Mini, iMac	OS 10.6 and higher
Microsoft	Windows	XP/2000/Vista/7

**Note: The term “HID device” refers to a compatible Bluetooth device.**

## COMPONENTS

### FRONT VIEW

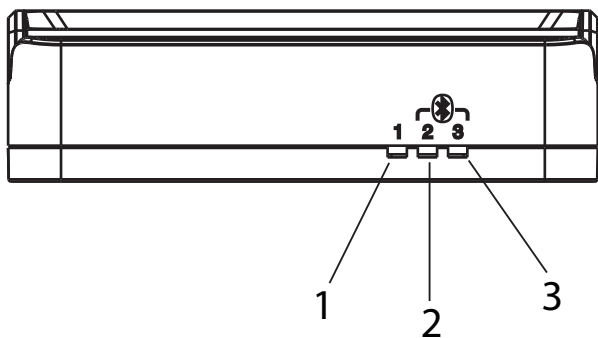

### REAR VIEW

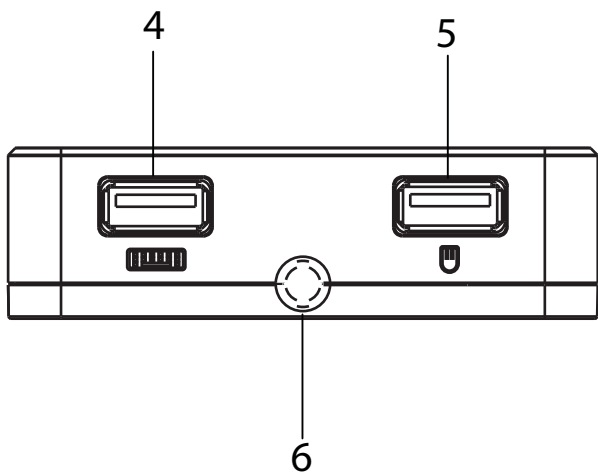

## TOP VIEW

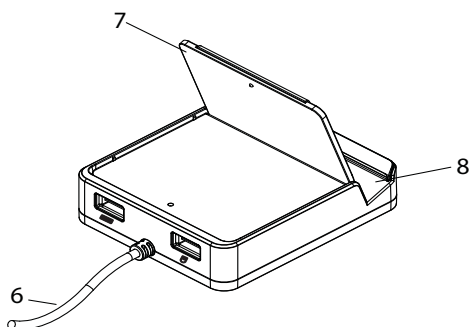

No.	Component	Description
1	Port 1 LED (USB / Power Supply)	Blue LED: light indicates USB Port 1 is connected for use with the keyboard and mouse.
2	Port 2 LED (Bluetooth)	Blue LED: light indicates Bluetooth Port 2 is connected for use with the keyboard and mouse.
3	Port 3 LED (Bluetooth)	Blue LED: light indicates Bluetooth Port 3 is connected for use with the keyboard and mouse.
4	USB Keyboard Port	Use this port to plug in your USB Keyboard.
5	USB Mouse Port	Use this port to plug in your USB mouse.
6	USB Cable	This USB cable plugs into your computer, or USB power adapter to provide power and connectivity to the CS533.
7	Plastic Stand	This plastic backing provides an adjustable stand for your Bluetooth device.
8	Cradle	Holds your Bluetooth device.

## INSTALLATION



1. Make sure that the power to any device that you connect to the installation has been turned off. You must unplug the power cords of any computers that have the *Keyboard Power On* function.
2. Make sure that all devices you will be installing are properly grounded.

## INSTRUCTIONS

To use your CS533 Tap you must first setup the hardware, and pair the Bluetooth connections.

### HARDWARE SETUP

To setup the hardware use the diagram below, and do the following:

1. Plug the CS533's USB Cable into your computers USB port
2. Plug a USB mouse into the USB Mouse port
3. Plug a USB keyboard into the USB Keyboard Port
4. Place the Plastic Stand in the cradle's slot and adjust it according to your preference.
5. Place your Bluetooth device on or near the cradle.

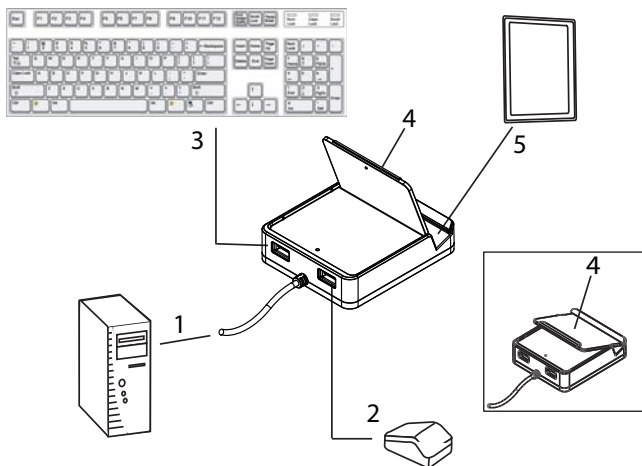

## BLUETOOTH SETUP

With the hardware setup, the CS533 Tap can establish two Bluetooth connections to share USB keyboard and mouse use with the computer.

To establish a paired Bluetooth connection with the CS533, do the following:

1. From the USB keyboard use the Hotkey: **[Alt]+[F2]** to switch to: *Port 2 Bluetooth* (see *Port Selection*, page 15).
2. Enable Bluetooth discovery mode on your HID device.
3. Discover and pair a Bluetooth connection with:  
**CS533**
4. Enter the passkey provided by your HID device\*
5. Once the Bluetooth connection is paired with **CS533**, the CS533 is ready to use.
6. To pair a second HID device: repeat step 1 using Hotkey **[Alt]+[F3]** to switch to: *Port 3 Bluetooth*, and continue with steps 2~5.

---

\*The HID device will generate and display a password to establish paired connections.

---

## USING THE CS533

### PORT SELECTION

The port selected for use with the USB keyboard/mouse is indicated by the blue LED light on the front panel, and when lit has exclusive use. Each port represents a device connection to the keyboard/mouse: Port 1- USB Computer, Port 2- Bluetooth, and Port 3- Bluetooth.

To switch USB keyboard and mouse use between your computer and HID devices, you switch the port using hotkeys from the Hotkey Table (page 16).

### SWITCHING PORTS

To switch ports: hold the [Alt] key, then press a hotkey to activate its function. Example:

Hotkey: **[Alt]+[F1]** switches to *Port 1 (USB)*

Hotkey: **[Alt]+[F2]** switches to *Port 2 (Bluetooth)*

Hotkey: **[Alt]+[F3]** switches to *Port 3 (Bluetooth)*

### MOUSE USAGE

To use a mouse on an HID Bluetooth device depends on if the manufacturer installs mouse capabilities with it. Some manufacturers do not include mouse capabilities with their device. Please consult your devices user manual for more information on mouse functionality, and to see whether it has been installed.

## HOTKEYS

Hotkeys are used from your USB keyboard to initiate CS533 functions such as; switching ports, connecting/disconnecting Bluetooth pairs, resetting default settings, and enabling keyboard mappings. The chart below lists all of the hotkeys and their related functions.

HOTKEY TABLE		
HotKey	Function	Description
[Alt] + [FN]  (FN = F1, F2, F3)	Switch to Port: F1: <i>Port 1 (USB)</i> F2: <i>Port 2 (Bluetooth)</i> F3: <i>Port 3 (Bluetooth)</i>	Switches use to the port indicated
[Alt] + [Ctrl]	Switch Port: Forward	Switches use to the next port
[Alt] + [-]	Switch Port: Back	Switches use to the previously used port
[Alt] + [F6]	Disconnect & Clear Bluetooth Pairing	Disconnects the Bluetooth pair for the selected port
[Alt] + [F7]	Reset default settings	Resets the CS533 to the default factory settings
[Alt] + [F8] then [p] + [Enter]	Firmware Upgrade	Invokes Firmware Upgrade Mode
[Alt] + [F5] then [num] + [enter]  (num = 1, 2, 3)	Enable Keyboard Mapping: 1: QWERTY 2: Mac 3: iPad/iPhone	Sets custom keyboard mappings for different keyboard layouts <i>See Custom Keyboard Settings, page 17</i>
[Alt] + [F4]	Print Settings	Prints the current CS533 settings



## **CUSTOM KEYBOARD SETTINGS**

The CS533 Tap can customize the USB keyboard to mimic the layout of different keyboards: QWERTY (standard PC), Mac (Apple computer), and iPad/iPhone for each port.

To change the keyboard layout for a port use the *Enable Keyboard Mapping* Hotkey:

**[Alt] + [F5] then [1] + [enter] = QWERTY**



**[Alt] + [F5] then [2] + [enter] = Mac**



**[Alt] + [F5] then [3] + [enter] = iPad/iPhone**



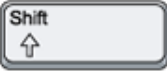

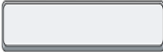
Once you've enabled a new keyboard mapping for a port, the keyboard will function according to the Keyboard Mapping Tables, beginning on page 18.

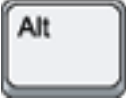
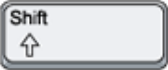
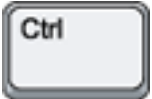



## KEYBOARD MAPPING TABLES





### PC KEYBOARD MAPPING



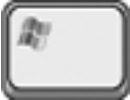

USB Keyboard		MAC Report	iPad Report	iPhone Report
	Left-Control	Left-Control	Left-Control	Left-Control
	Left-Shift	Left-Shift	Left-Shift	Left-Shift
	Left-Alt	Left-Option	Left-Option	Left-Option
	Left- Windows Key	Left- Command	Left- Command	Left- Command
	Space Bar	Space Bar	Space Bar	Space Bar





USB Keyboard		MAC Report	iPad Report	iPhone Report
	Right-Alt	Right-Option	Right-Option	Right-Option
	Right-Shift	Right-Shift	Right-Shift	Right-Shift
	Right-Control	Right-Control	Right-Control	Right-Control
	Escape	Escape	www Home	www Home
	F1	Brightness Down/F1	Brightness Down	Brightness Down

USB Keyboard		MAC Report	iPad Report	iPhone Report
	F2	Brightness up/F2	Brightness up	Brightness up
	F3	Expose/F3	Spotlight Search	Spotlight Search
	F4	DashBoard/ F4	Picture Frame Mode	Picture Frame Mode (iOS5) Screen Lock (iOS4)
	F5	F5	On-Screen Keyboard	On-Screen Keyboard
	F6	F6		

USB Keyboard		MAC Report	iPad Report	iPhone Report
	F7	Rewind/F7	Rewind	Rewind
	F8	Play/Pause/ F8	Play/Pause	Play/ Pause
	F9	Fast Forward/F9	Fast Forward	Fast Forward
	F10	Mute/F10	Mute	Mute
	F11	Volume Down/F11	Volume Down	Volume Down

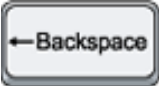
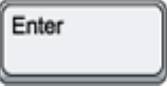





USB Keyboard		MAC Report	iPad Report	iPhone Report
	F12	Volume Up/ F12	Volume Up	Volume Up
 + 	Windows Key + E	CD Eject		
	Delete	Delete Forward	Delete Forward	Delete Forward
	Print Screen	F13		







USB Keyboard		MAC Report	iPad Report	iPhone Report
	Scroll Lock	F14		
	Home	Home		
	End	End		
	Page Up	Page Up		
	Page Down	Page Down		







USB Keyboard		MAC Report	iPad Report	iPhone Report
	Backspace	Delete Backward	Delete Backward	Delete Backward
	Enter	Return	Return	Return
	Insert	Fn		
	Pause	F15		
	Num Lock	Clear		







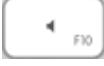







## MAC KEYBOARD MAPPING

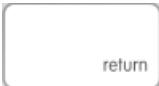

MAC Keyboard	PC Report	iPad Report	iPhone Report
	Left Control	Left Control	Left Control
	Left Shift	Left Shift	Left Shift
	Left Option	Left Alt	Left Option
	Left Command	Left GUI	Left Command
	Space Bar	Space Bar	Space Bar
	Right Option	Right Alt	Right Option

MAC Keyboard	PC Report	iPad Report	iPhone Report
	Right Shift	Right Shift	Right Shift
	Right Control	Right Control	Right Control
	Escape	Escape	www Home
	Brightness Down/F1	F1	Brightness Down
	Brightness Up/F2	F2	Brightness Up
	Expose/F3	F3	Spotlight Search
	Dash Board	F4	Picture Frame Mode Picture Frame Mode Screen Lock (iOS4)

MAC Keyboard		PC Report	iPad Report	iPhone Report
	F5	F5	On-Screen Keyboard	On-Screen Keyboard
	F6	F6		
	Rewind/F7	F7	Rewind	Rewind
	Play/Pause/F8	F8	Play/Pause/F8	Play/Pause
	Fast Forward/F9	F9	Fast Forward	Fast Forward
	Mute/F10	F10	Mute	Mute
	Volume Down/F11	F11	Volume Down	Volume Down
	Volume Up/F12	F12	Volume Up	Volume Up

MAC Keyboard		PC Report	iPad Report	iPhone Report
	Eject			
	F13	Print Screen		
	F14	Scroll Lock		
	F15	Pause		
	F16			
	F17			
	F18			
	F19			

MAC Keyboard		PC Report	iPad Report	iPhone Report
	Delete Forward	Delete	Delete Forward	Delete Forward
	Delete Backward	Back Space	Delete Backward	Delete Backward
	Return	Enter	Return	Return
	Help/FN	Insert		
	Home	Home		
	End	End		
	Page Up	Page Up		

MAC Keyboard		PC Report	iPad Report	iPhone Report
	Page Down	Page Down		
	Clear	Num Lock		

## STANDARD KEYBOARD COMMANDS

Below are standard key combinations used to Copy, Paste, Cut, Restore, Select, Select All, and invoke IME Change on Apple and PC Keyboards, with respect to the operating system, when using the CS533 Tap:

### Apple Keyboard:

Function	Mac OS	Windows OS
Copy	[command] + C	[Ctrl] + C
Paste	[command] + V	[Ctrl] + V
Cut	[command] + X	[Ctrl] + X
Restore	[command] + Z	[Ctrl] + Z
Select All	[command] + A	[Ctrl] + A
Select	[Shift] + [Arrow Keys]	[Shift] + [Arrow Keys]
IME Change*	[command] + [space Bar]	[Ctrl] + [Space Bar]

### PC Keyboard:

Function	Mac OS	Windows OS
Copy	[Windows Key] + C	[Ctrl] + C
Paste	[Windows Key] + V	[Ctrl] + V
Cut	[Windows Key] + X	[Ctrl] + X
Restore	[Windows Key] + Z	[Ctrl] + Z
Select All	[Windows Key] + A	[Ctrl] + A
Select	[Shift] + [Arrow Keys]	[Shift] + [Arrow Keys]
IME Change*	[Windows Key] + [Space Bar]	[Ctrl] + [Space Bar]

\*An Input Method Editor (IME) is an operating system component that allows data such as keyboard strokes to be received as input. For instance, this allows users of English or Latin keyboards to input Chinese or Japanese characters.

## FIRMWARE UPGRADE

To upgrade the firmware, do the following:

1. From the computer and keyboard that is connected to your CS533, go to our Internet support site (<http://eService.aten.com>) and choose the CS533 to get a list of available Firmware Upgrade Packages.
2. Download the appropriate CS533 firmware upgrade package to your computer.
3. Invoke Firmware Upgrade Mode by pressing hotkey: **[Alt]+[F8]**, then **[P]+[Enter]**.  
The front panel LEDs flash together to indicate Firmware Upgrade Mode is in effect.
4. Run the downloaded Firmware Upgrade Package file – either by double clicking the file icon, or by opening a command line and entering the full path to it.
5. Follow the installation instructions to complete the CS533 upgrade process.
6. After the upgrade process is complete, unplug the CS533's USB cable that is connected to the PC, and re-plug it into the PC.



## SPECIFICATIONS

Function		CS533
PC / Bluetooth Connections		1/2
Port Selection		Hotkey
Connectors	Keyboard	1 x USB Type A Female (White)
	Mouse	1 x USB Type A Female (White)
	Power Supply	1 x USB Type A Male (White)
Cable Length	Computer	0.9 m
LEDs	USB Selected/Power Supply	1 (Blue)
	Bluetooth Selected	2 (Blue)
Emulation	Keyboard	USB
		Bluetooth V2.1, Class 2
	Mouse	USB
		Bluetooth V2.1, Class 2
Power Consumption		5v, W
Environment	Operating Temp.	0–50°C
	Storage Temp.	-20–60°C
	Humidity	0–80% RH, Non-condensing
Physical Properties	Housing	Plastic
	Weight	112 g
	Dimensions (L x W x H)	92 x 78 x 24.55 mm

## **LIMITED WARRANTY**

IN NO EVENT SHALL THE DIRECT VENDOR'S LIABILITY EXCEED THE PRICE PAID FOR THE PRODUCT FROM THE DIRECT, INDIRECT, SPECIAL, INCIDENTAL OR CONSEQUENTIAL DAMAGES RESULTING FROM THE USE OF THE PRODUCT, DISK OR ITS DOCUMENTATION.

The direct vendor makes no warranty or representation, expressed, implied, or statutory with respect to the contents or use of this documentation, and specially disclaims its quality, performance, merchantability, or fitness for any particular purpose.

The direct vendor also reserves the right to revise or update the device or documentation without obligation to notify any individual or entity of such revisions, or update. For further inquires please contact your direct vendor.