

## Features

### Multi-voltage and multi-function timer range - Front panel or socket mount

- 8 - 11 pin plug-in version available
- Time scales from 0.05s to 100h
- "1 delayed contact + 1 instantaneous contact" version available (type 88.12)
- Front panel mount
- 90 series sockets

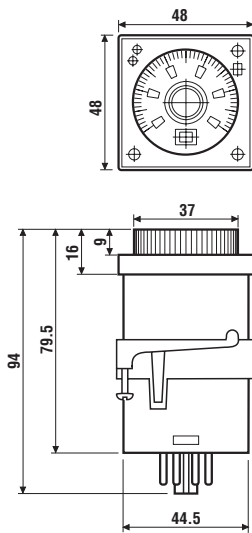

### 88.02

**NEW**



- Multi-function
- 11 pin
- Plug-in for use with 90 series sockets

**AI:** ON delay  
**DI:** ON pulse  
**GI:** Fixed pulse (1s) delayed  
**SW:** Symmetrical recycling: ON start

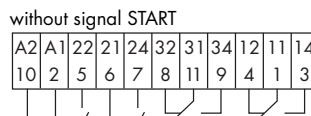

**BE:** Signal OFF delay  
**CE:** Signal ON and OFF delay  
**DE:** Signal ON pulse

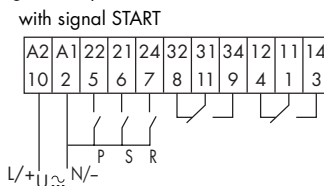

### 88.12

**NEW**



- Multi-function
- 8 pin, 2 timed contacts or 1 timed + 1 instantaneous contact
- Plug-in for use with 90 series sockets

**AI a:** ON Delay (2 timed contacts)  
**AI b:** ON Delay (1 timed + 1 instantaneous contact)  
**DI a:** ON Pulse (2 timed contacts)  
**DI b:** ON Pulse (1 timed + 1 instantaneous contact)  
**GI:** Fixed pulse (0.5s) delayed  
**SW:** Symmetrical recycling: ON start

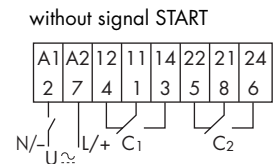

Contact specification			
Contact configuration		2 CO (DPDT)	2 CO (DPDT)
Rated current/Maximum peak current	A	8/15	5/10
Rated voltage/Maximum switching voltage V AC		250/250	250/400
Rated load AC1	VA	2,000	1,250
Rated load AC15 (230 V AC)	VA	400	250
Single phase motor rating (230 V AC)	kW	0.3	0.125
Breaking capacity DC1: 30/110/220 V	A	8/0.3/0.12	5/0.3/0.12
Minimum switching load	mW(V/mA)	300 (5/5)	500 (5/5)
Standard contact material		AgNi	AgCdO
Supply specification			
Nominal voltage (U <sub>N</sub> )	V AC (50/60 Hz)	24...230	24...230
	V DC	24...230	24...230
Rated power AC/DC	VA (50 Hz)/W	2.5 (230 V)/1.5 (24 V)	2.5 (230 V)/1.5 (24 V)
Operating range	AC	20.4...264.5	20.4...264.5
	DC	20.4...264.5	20.4...264.5
Technical data			
Specified time range		(0.05 s...5 h) - (0.05 s...10 h) - (0.05 s...50 h) - (0.05 s...100 h)	
Repeatability	%	± 1	± 1
Recovery time	ms	300	200
Minimum control impulse	ms	50	—
Setting accuracy-full range	%	± 3	± 3
Electrical life at rated load AC1	cycles	100·10 <sup>3</sup>	100·10 <sup>3</sup>
Ambient temperature range	°C	-10...+55	-10...+55
Protection category		IP 40	IP 40
<b>Approvals</b> (according to type)		<b>CE</b>	

## Ordering information

Example: 88 series multi-function timer, 2 CO (DPDT) contact 8 A, (24...230)V AC (50/60 Hz) and (24...230)V DC supply.

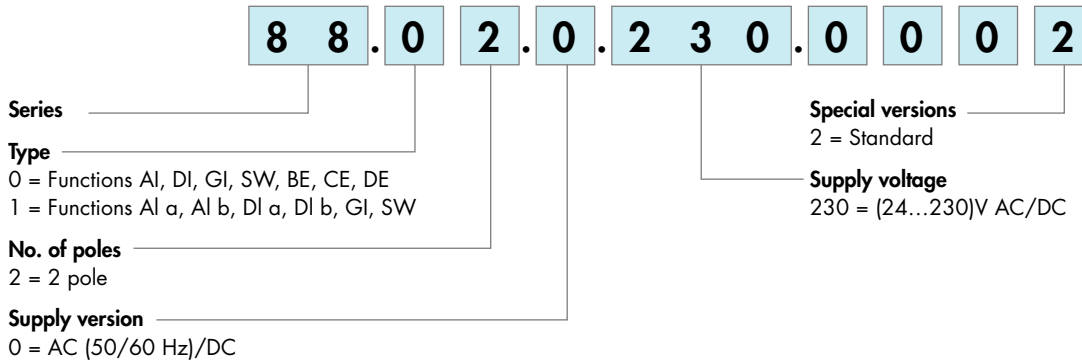

## Technical data

### EMC specifications

Type of test		Reference standard	
Electrostatic discharge	contact discharge	EN 61000-4-2	4 kV
	air discharge	EN 61000-4-2	8 kV
Radio-frequency electromagnetic field (80 ÷ 1000 MHz)		EN 61000-4-3	10 V/m
Fast transients (burst) (5-50 ns, 5 kHz) on Supply terminals		EN 61000-4-4	2 kV/5 kV
Surges (1.2/50 µs) on Supply terminals	common mode	EN 61000-4-5	2 kV
	differential mode	EN 61000-4-5	1 kV
Radio-frequency common mode (0.15 ÷ 80 MHz) on Supply terminals		EN 61000-4-6	3 V

## Selection of: function, time scale and units

	88.02	88.12
<b>E Function selector</b>	AI, DI, GI, SW, BE, CE, DE	AI a, AI b, DI a, DI b, GI, SW
<b>D Time scale selector</b>	0.5, 1, 5, 10	
<b>H Unit of time selector</b>	s (second), min (minute), h (hour), 10h (10 hour)	

## Time scales

### Full scale value

D	H	s	min	h	x10h
0.5		0.5 second	0.5 minute	0.5 hour	5 hour
1		1 second	1 minute	1 hour	10 hour
5		5 second	5 minute	5 hour	50 hour
10		10 second	10 minute	10 hour	100 hour

NOTE: time scales and functions must be set before energising the timer.

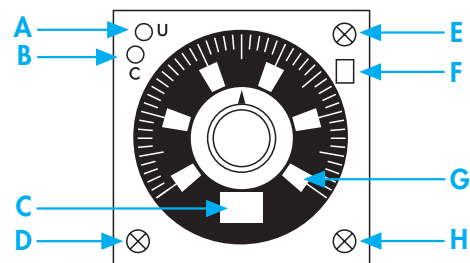

## LED/visual indication

<b>A</b>	Yellow LED: power ON (U)
<b>B</b>	Red LED: timing in progress (C)
<b>C</b>	Unit of time selected
<b>F</b>	Function selected
<b>G</b>	Time selected

**Functions**

- U** = Supply Voltage
- S** = Signal switch
- P** = Pause
- R** = Reset
- = Output Contact

LED (yellow)	LED (red)	Supply voltage	NO output contact	Contact	
				Open	Closed
		OFF	Open	x1 - x4	x1 - x2
		ON	Open	x1 - x4 x1 - x2	x1 - x2 x1 - x4
		ON	Open (timing in progress)	x1 - x4	x1 - x2
		ON	Closed	x1 - x2	x1 - x4

**Wiring diagram**

**Type 88.02**

without signal START

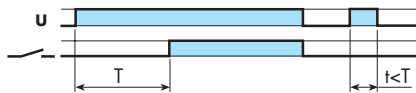
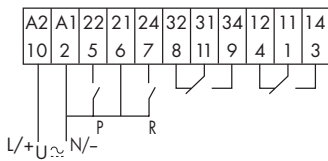

**(AI) ON delay.**

Apply power to timer. Output contacts transfer after preset time has elapsed. Reset occurs when power is removed.

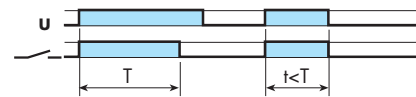

**(DI) ON pulse.**

Apply power to timer. Output contacts transfer immediately. After the preset time has elapsed, contacts reset.

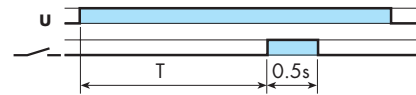

**(GI) Fixed pulse (0.5s) delayed.**

Apply power to timer. Output contacts transfer after preset time has elapsed. Reset occurs after a fixed time of 0.5s. 0.5s.

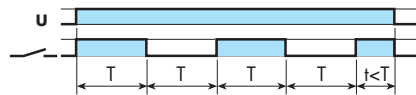

**(SW) Symmetrical recycling: ON start.**

Apply power to timer. Output contacts transfer immediately and cycle between ON and OFF for as long as power is applied. The ratio is 1:1 (time on = time off).

with signal START

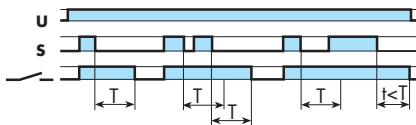
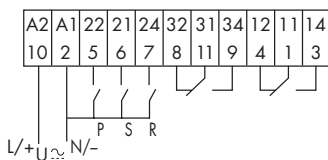

**(BE) Signal OFF delay.**

Power is permanently applied to the timer. The output contacts transfer immediately on closure of the Signal Switch (S). Opening the Signal Switch initiates the preset delay, after which time the output contacts reset.

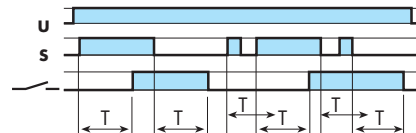

**(CE) Signal ON and OFF delay.**

Power is permanently applied to the timer. Closing the Signal Switch (S) initiates the preset delay, after which time the output contacts transfer. Opening the Signal switch initiates the same preset delay, after which time the output contacts reset.

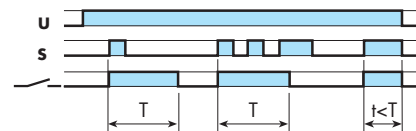

**(DE) Signal ON pulse.**

Power is permanently applied to the timer. On momentary or maintained closure of Signal Switch (S), the output contacts transfer, and remain so for the duration of the preset delay, after which they reset.

**RESET (R)**

A momentary closure of the reset switch (2-7) will reset the timer. Longer term closure of the reset switch will hold the timer in the reset state. This is applicable for all functions.

**PAUSE (P)**

Closure of the pause switch (2-5) will immediately halt the timing process, but the elapsed time will be retained, and the current state of the output contacts will be maintained. On opening of the pause switch, timing resumes from the retained value. This is applicable for all functions.

**Functions**

**Wiring diagram**

**Type 88.12**

without signal START

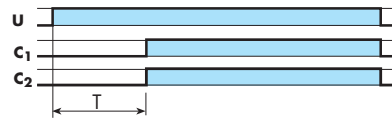
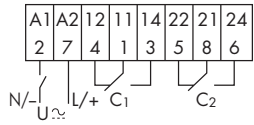

**(AI a) ON Delay (2 timed contacts).**

Apply power to timer.

Contacts (C<sub>1</sub> and C<sub>2</sub>) transfer after preset time has elapsed.

Reset occurs when power is removed.

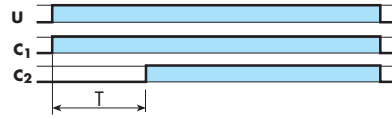

**(AI b) ON Delay**

**(1 timed contact + 1 instantaneous contact).**

Apply power to timer. Output contact (C<sub>1</sub>) transfers

immediately. Contact (C<sub>2</sub>) transfers after the preset time has

elapsed. Reset occurs when power is removed.

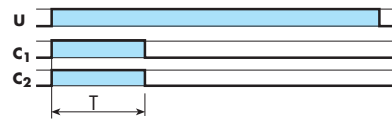

**(DI a) ON pulse (2 timed contacts).**

Apply power to timer.

Output contacts (C<sub>1</sub> and C<sub>2</sub>) transfer immediately. After

preset time has elapsed, the contacts reset.

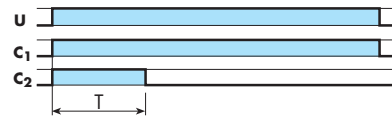

**(DI b) ON pulse**

**(1 timed contact + 1 instantaneous contact).**

Apply power to timer. Output contacts (C<sub>1</sub> and C<sub>2</sub>) transfer

immediately. After preset time has elapsed, the contact (C<sub>2</sub>)

resets. Contact (C<sub>1</sub>) resets when power is removed.

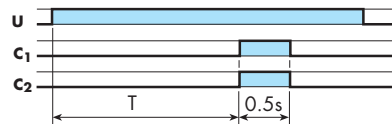

**(GI) Fixed pulse (0.5s) delayed.**

Apply power to timer. Output contacts transfer after preset

time has elapsed. Reset occurs after a fixed time of 0.5s.

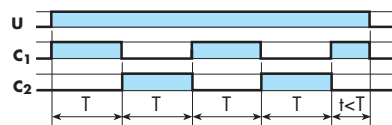

**(SW) Symmetrical recycling: ON start.**

Apply power to timer. Output contacts transfer immediately

and cycle between ON and OFF for as long as power is

applied. The ratio is 1:1 (time on = time off).



90.21

Approvals  
(according to type):



Screw terminal (Box clamp) socket	90.20	90.20.0	90.21	90.21.0
panel or 35 mm rail (EN 50022) mount	<b>Blue</b>	<b>Black</b>	<b>Blue</b>	<b>Black</b>
For timer type	88.12		88.02	
<b>Technical data</b>				
Rated values	10 A - 250 V			
Dielectric strength	≥ 2 kV AC			
Protection category	IP 20			
Ambient temperature	°C -40...+70			
⊕ Screw torque	Nm 0.5			
Wire strip length	mm 10			
Max. wire size for 90.20 and 90.21 sockets	solid wire		stranded wire	
	mm <sup>2</sup> 1x6 / 2x2.5		1x6 / 2x2.5	
	AWG 1x10 / 2x14		1x10 / 2x14	

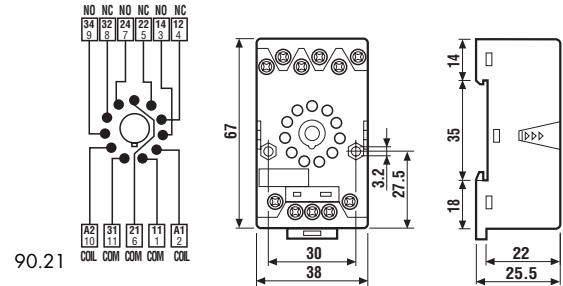
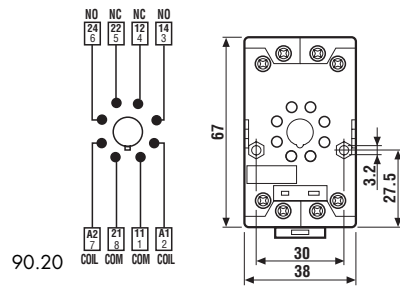

90.26

Approvals  
(according to type):



Screw terminal (Plate clamp) socket	90.26	90.26.0	90.27	90.27.0
panel or 35 mm rail (EN 50022) mount	<b>Blue</b>	<b>Black</b>	<b>Blue</b>	<b>Black</b>
For timer type	88.12		88.02	
<b>Technical data</b>				
Rated values	10 A - 250 V			
Dielectric strength	≥ 2 kV AC			
Protection category	IP 20			
Ambient temperature	°C -40...+70			
⊕ Screw torque	Nm 0.8			
Wire strip length	mm 10			
Max. wire size for 90.26 and 90.27 sockets	solid wire		stranded wire	
	mm <sup>2</sup> 1x4 / 2x2.5		1x4 / 2x2.5	
	AWG 1x12 / 2x14		1x12 / 2x14	

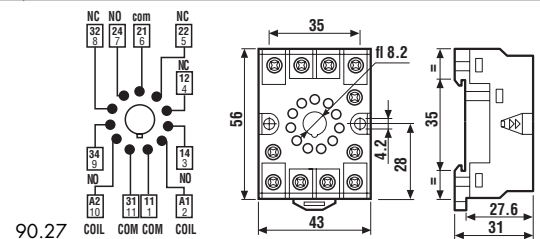
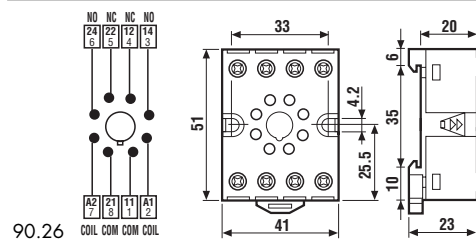

90.13.4

Approvals  
(according to type):



Sockets 8-11 pin backwired with solder terminals	—	90.12.4 (black)	—	90.13.4 (black)
For timer type	—	88.12	—	88.02
<b>Technical data</b>				
Rated values	10 A - 250 V			
Dielectric strength	≥ 2 kV AC			
Ambient temperature	°C -40...+70			

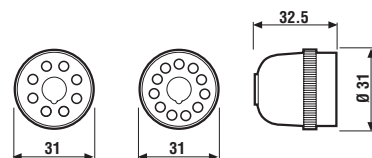

90.12.4

90.13.4

