

Optocoupler, Phototransistor Output (Dual, Quad Channel)

Features

- Alternate Source to TLP621-2/-4 and TLP621GB-2/-4
- High Collector-Emitter Voltage, $BV_{CEO}=70\text{ V}$
- Dual and Quad Packages Feature:
 - Lower Pin and Parts Count
 - Better Channel to Channel CTR Match
 - Improved Common Mode Rejection
- Isolation Test Voltage 5300 V_{RMS}

Agency Approvals

- UL File # E52744 System Code H or J
- DIN EN 60747-5-2(VDE0884)
DIN EN 60747-5-5 pending
Available with Option 1
- BSI IEC60950 IEC60965
- FIMKO

Description

The ILD621/ ILQ621 and ILD621GB/ ILQ621GB are multi-channel phototransistor optocouplers that use GaAs IRLED emitters and high gain NPN silicon phototransistors. These devices are constructed using double molded insulation technology. This assembly process offers a withstand test voltage of 7500 VDC. The ILD621/ ILQ621GB is well suited for CMOS interfacing given the $CTR_{CE\ sat}$ of 30 % minimum at I_F of 1.0 mA. High gain linear operation is guaranteed by a minimum CTR_{CE} of 100 % at 5.0 mA. The ILD/Q621 has a guaranteed CTR_{CE} 50 % minimum at 5.0 mA. The TRansparent IOn Shield insures stable DC gain in applications such as power supply feedback circuits, where constant DC V_{IO} voltages are present.

Dual Channel

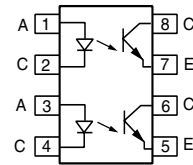
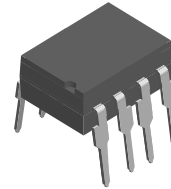

Quad Channel

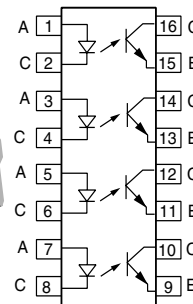
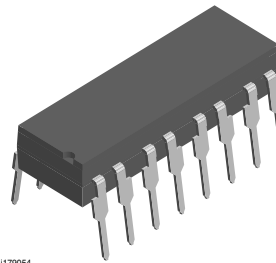

Order Information

Part	Remarks
ILD621	CTR > 50 %, DIP-8
ILD621GB	CTR > 100 %, DIP-8
ILQ621	CTR > 50 %, DIP-16
ILQ621GB	CTR > 100 %, DIP-16
ILD621-X006	CTR > 50 %, DIP-8 400 mil (option 6)
ILD621-X007	CTR > 50 %, SMD-8 (option 7)
ILD621-X009	CTR > 50 %, SMD-8 (option 9)
ILD621GB-X007	CTR > 100 %, SMD-8 (option 7)
ILQ621-X006	CTR > 50 %, DIP-8 400 mil (option 6)
ILQ621-X007	CTR > 50 %, SMD-16 (option 7)
ILQ621-X009	CTR > 50 %, SMD-16 (option 9)
ILQ621GB-X006	CTR > 100 %, DIP-16 400 mil (option 6)
ILQ621GB-X007	CTR > 100 %, SMD-16 (option 7)
ILQ621GB-X009	CTR > 100 %, SMD-16 (option 9)

For additional information on the available options refer to Option Information.

Absolute Maximum Ratings

$T_{amb} = 25\text{ }^{\circ}\text{C}$, unless otherwise specified

Stresses in excess of the absolute Maximum Ratings can cause permanent damage to the device. Functional operation of the device is not implied at these or any other conditions in excess of those given in the operational sections of this document. Exposure to absolute Maximum Rating for extended periods of the time can adversely affect reliability.

Input

Parameter	Test condition	Symbol	Value	Unit
Reverse voltage		V_R	6.0	V
Forward current		I_F	60 mA	mA
Surge current		I_{FSM}	1.5	A
Power dissipation		P_{diss}	100	mW
Derate from 25 °C			1.33	mW/°C

Output

Parameter	Test condition	Symbol	Value	Unit
Collector -emitter reverse voltage		V_{ECO}	70	V
Collector current		I_C	50	mA
	$t < 1.0\text{ ms}$	I_C	100	mA
Power dissipation		P_{diss}	150	mW
Derate from 25 °C			- 2.0	mW/°C

Coupler

Parameter	Test condition	Part	Symbol	Value	Unit
Isolation test voltage	$t = 1.0\text{ sec.}$		V_{ISO}	5300	V_{RMS}
Package dissipation		ILD621		400	mW
		ILD621GB		400	mW
Derate from 25 °C				5.33	mW/°C
Package dissipation		ILQ621		500	mW
		ILQ621GB		500	mW
Derate from 25 °C				6.67	mW/°C
Creepage				≥ 7.0	mm
Clearance				≥ 7.0	mm
Isolation resistance	$V_{IO} = 500\text{ V}, T_{amb} = 25\text{ }^{\circ}\text{C}$		R_{IO}	$\geq 10^{12}$	Ω
	$V_{IO} = 500\text{ V}, T_{amb} = 100\text{ }^{\circ}\text{C}$		R_{IO}	$\geq 10^{11}$	Ω
Storage temperature			T_{stg}	- 55 to +150	°C
Operating temperature			T_{amb}	- 55 to +100	°C
Junction temperature			T_j	100	°C
Soldering temperature	2.0 mm from case bottom		T_{sld}	260	°C



Electrical Characteristics

T_{amb} = 25 °C, unless otherwise specified

Minimum and maximum values are testing requirements. Typical values are characteristics of the device and are the result of engineering evaluation. Typical values are for information only and are not part of the testing requirements.

Input

Parameter	Test condition	Symbol	Min	Typ.	Max	Unit
Forward voltage	I _F = 10 mA	V _F	1.0	1.15	1.3	V
Reverse current	V _R = 6.0 V	I _R		0.01	10	μA
Capacitance	V _F = 0, f = 1.0 MHz	C _O		40		pF
Thermal resistance, Junction to lead		R _{THJL}		750		K/W

Output

Parameter	Test condition	Symbol	Min	Typ.	Max	Unit
Collector-emitter capacitance	V _{CE} = 5.0 V, f = 1.0 MHz	C _{CE}		6.8		pF
Collector-emitter leakage current	V _{CE} = 24 V	I _{CEO}		10	100	nA
		I _{CEO}		20	50	μA
Thermal resistance, Junction to lead		R _{THJL}		500		K/W

Coupler

Parameter	Test condition	Part	Symbol	Min	Typ.	Max	Unit
Capacitance (input-output)	V _{IO} = 0 V, f = 1.0 MHz		C _{IO}	0.8			pF
Insulation resistance	V _{IO} = 500 V			10 ¹²			Ω
Channel to channel insulation				500			VAC
Collector-emitter saturation voltage	I _F = 8.0 mA, I _{CE} = 2.4 mA	ILD621 ILQ621	V _{CEsat}			0.4	V
	I _F = 1.0 mA, I _{CE} = 0.2 mA	ILD621GB ILQ621GB	V _{CEsat}			0.4	V

Current Transfer Ratio

Parameter	Test condition	Part	Symbol	Min	Typ.	Max	Unit
Channel/Channel CTR match	I _F = 5.0 mA, V _{CE} = 5.0 V		CTR _X / CTR _Y	1 to 1		3 to 1	
Current Transfer Ratio (collector-emitter saturated)	I _F = 1.0 mA, V _{CE} = 0.4 V	ILD621 ILQ621	CTR _{CEs} at		60		%
		ILD621GB ILQ621GB	CTR _{CEs} at	30			%
Current Transfer Ratio (collector-emitter)	I _F = 5.0 mA, V _{CE} = 5.0 V	ILD621 ILQ621	CTR _{CE}	50	80	600	%
		ILD621GB ILQ621GB	CTR _{CE}	100	200	600	%

Switching Characteristics

Non-saturated switching timing

Parameter	Test condition	Symbol	Min	Typ.	Max	Unit
On Time	$I_F = \pm 10 \text{ mA}$, $V_{CC} = 5.0 \text{ V}$, $R_L = 75 \Omega$, 50 % of V_{PP}	t_{on}		3.0		μs
Rise time	$I_F = \pm 10 \text{ mA}$, $V_{CC} = 5.0 \text{ V}$, $R_L = 75 \Omega$, 50 % of V_{PP}	t_r		2.0		μs
Off time	$I_F = \pm 10 \text{ mA}$, $V_{CC} = 5.0 \text{ V}$, $R_L = 75 \Omega$, 50 % of V_{PP}	t_{off}		2.3		μs
Fall time	$I_F = \pm 10 \text{ mA}$, $V_{CC} = 5.0 \text{ V}$, $R_L = 75 \Omega$, 50 % of V_{PP}	t_f		2.0		μs
Propagation H-L	$I_F = \pm 10 \text{ mA}$, $V_{CC} = 5.0 \text{ V}$, $R_L = 75 \Omega$, 50 % of V_{PP}	t_{PHL}		1.1		μs
Propagation L-H	$I_F = \pm 10 \text{ mA}$, $V_{CC} = 5.0 \text{ V}$, $R_L = 75 \Omega$, 50 % of V_{PP}	t_{PLH}		2.5		μs

Saturated switching timing

Parameter	Test condition	Symbol	Min	Typ.	Max	Unit
On time	$I_F = \pm 10 \text{ mA}$, $V_{CC} = 5.0 \text{ V}$, $R_L = 1.0 \text{ K}\Omega$, $V_{TH} = 1.5 \text{ V}$	t_{on}		4.3		μs
Rise time	$I_F = \pm 10 \text{ mA}$, $V_{CC} = 5.0 \text{ V}$, $R_L = 1.0 \text{ K}\Omega$, $V_{TH} = 1.5 \text{ V}$	t_r		2.8		μs
Off time	$I_F = \pm 10 \text{ mA}$, $V_{CC} = 5.0 \text{ V}$, $R_L = 1.0 \text{ K}\Omega$, $V_{TH} = 1.5 \text{ V}$	t_{off}		2.5		μs
Fall time	$I_F = \pm 10 \text{ mA}$, $V_{CC} = 5.0 \text{ V}$, $R_L = 1.0 \text{ K}\Omega$, $V_{TH} = 1.5 \text{ V}$	t_f		11		μs
Propagation H-L	$I_F = \pm 10 \text{ mA}$, $V_{CC} = 5.0 \text{ V}$, $R_L = 1.0 \text{ K}\Omega$, $V_{TH} = 1.5 \text{ V}$	t_{PHL}		2.6		μs
Propagation L-H	$I_F = \pm 10 \text{ mA}$, $V_{CC} = 5.0 \text{ V}$, $R_L = 1.0 \text{ K}\Omega$, $V_{TH} = 1.5 \text{ V}$	t_{PLH}		7.2		μs

Common Mode Transient Immunity

Parameter	Test condition	Symbol	Min	Typ.	Max	Unit
Common mode rejection output high	$V_{CM} = 50 \text{ V}_{P-P}$, $R_L = 1.0 \text{ K}\Omega$, $I_F = 0 \text{ mA}$	CM_H		5000		$\text{V}/\mu\text{s}$
Common mode rejection output low	$V_{CM} = 50 \text{ V}_{P-P}$, $R_L = 1.0 \text{ K}\Omega$, $I_F = 10 \text{ mA}$	CM_L		5000		$\text{V}/\mu\text{s}$

Typical Characteristics ($T_{amb} = 25\text{ }^{\circ}\text{C}$ unless otherwise specified)

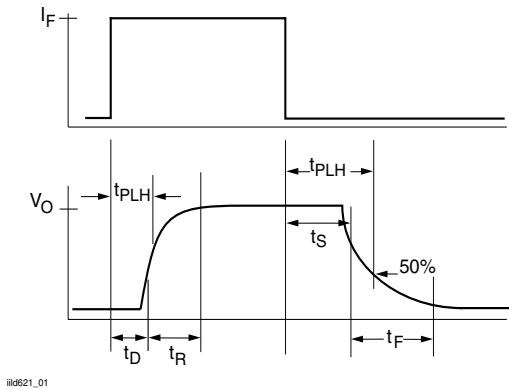
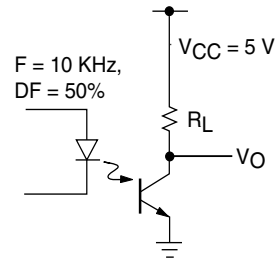

Fig. 1 Non-saturated Switching Timing

ild621_01



ild621_04

Fig. 4 Saturated Switching Timing

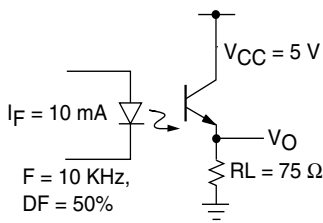

ild621_02

Fig. 2 Non-saturated Switching Timing

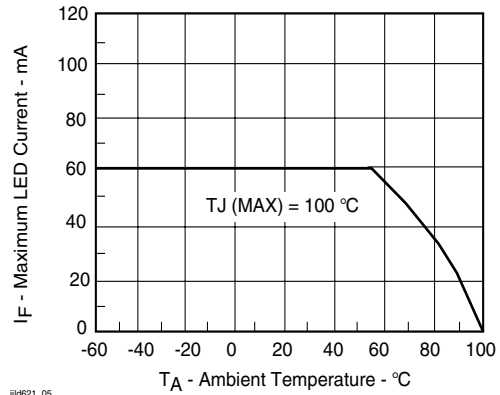

ild621_05

Fig. 5 Maximum LED Current vs. Ambient Temperature

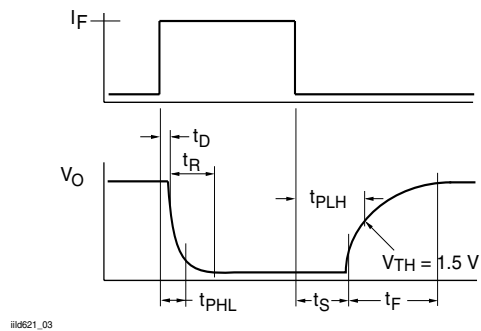

ild621_03

Fig. 3 Saturated Switching Timing

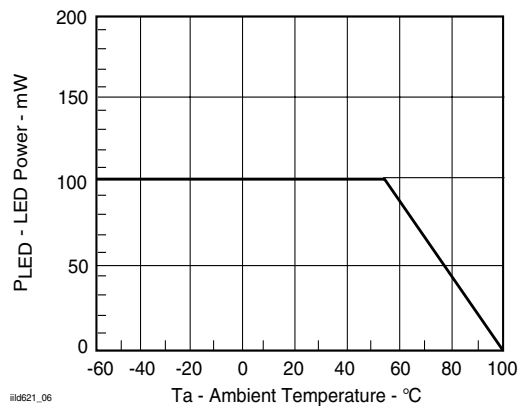

ild621_06

Fig. 6 Maximum LED Power Dissipation

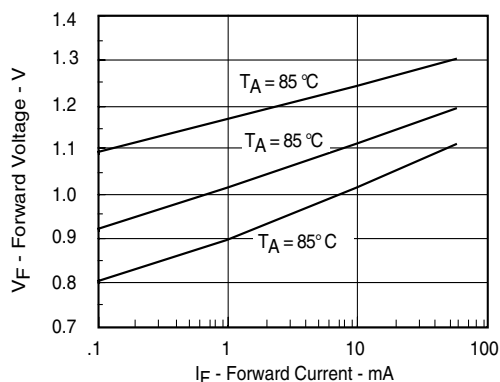

ild621_07

Fig. 7 Forward Voltage vs. Forward Current

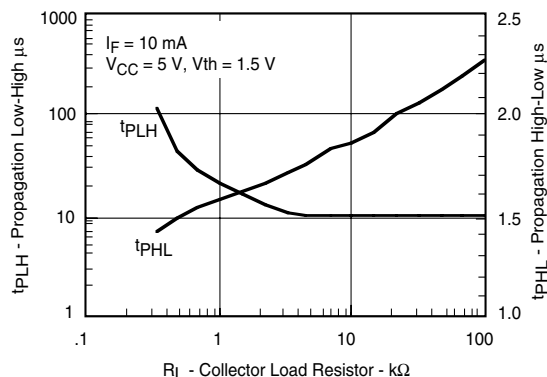

ild621_10

Fig. 10 Propagation Delay vs. Collector Load Resistor

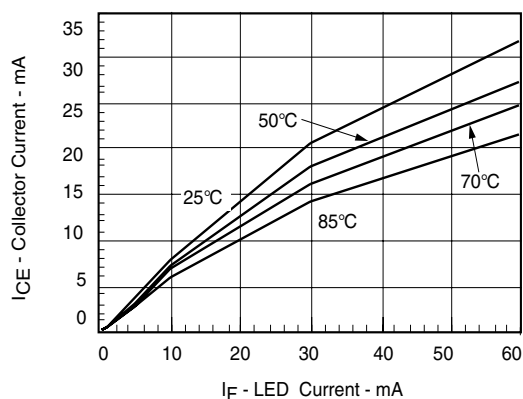

ild621_08

Fig. 8 Collector-Emitter Current vs. Temperature and LED Current

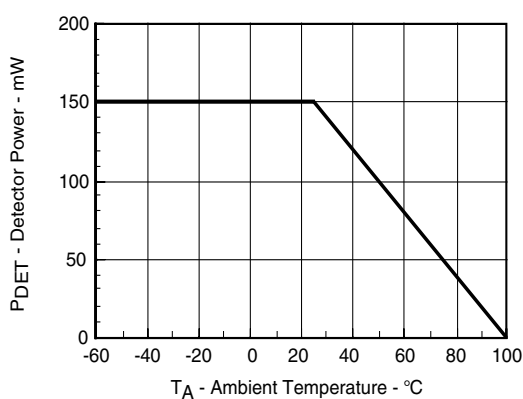

ild621_11

Fig. 11 Maximum Detector Power Dissipation

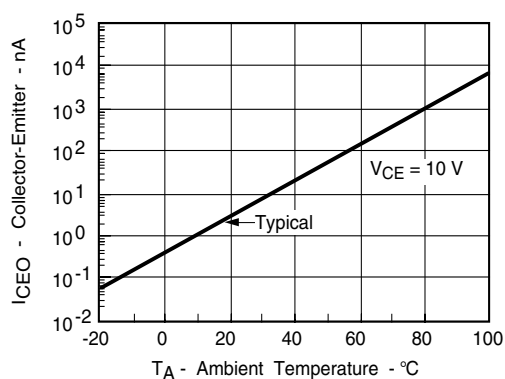

ild621_09

Fig. 9 Collector-Emitter Leakage vs. Temperature

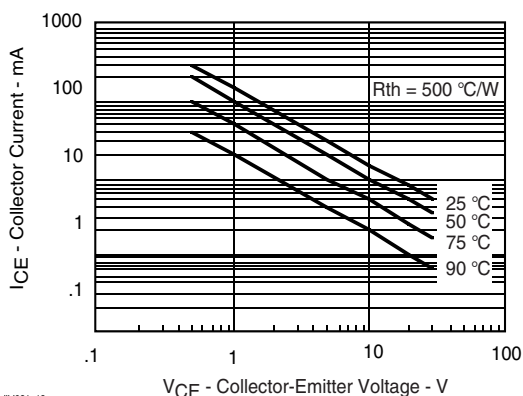

ild621_12

Fig. 12 Maximum Collector Current vs. Collector Voltage

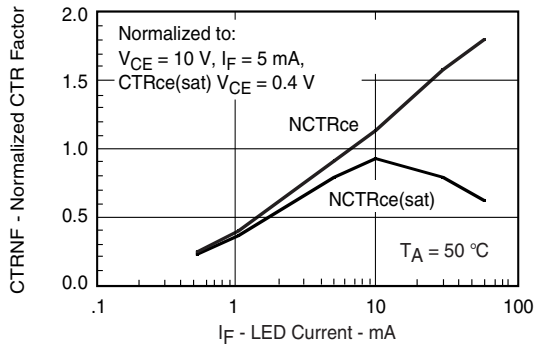

ild621_13

Fig. 13 Normalization Factor for Non-saturated and Saturated CTR vs. I_F

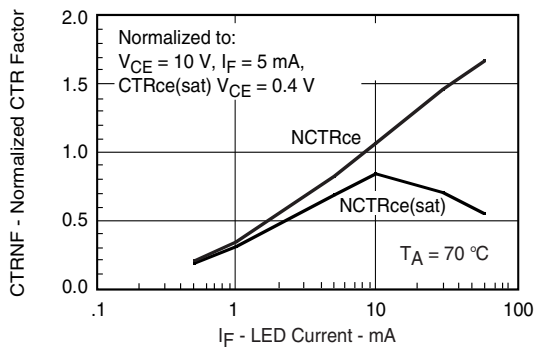

ild621_14

Fig. 14 Normalization Factor for Non-saturated and Saturated CTR vs. I_F

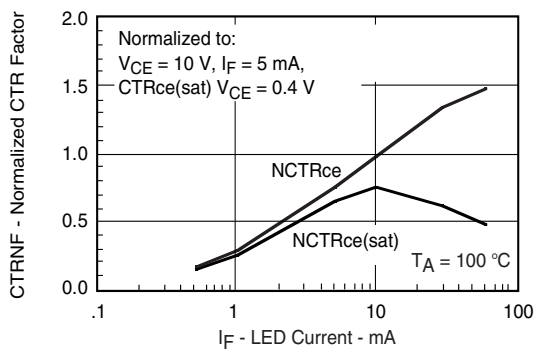

ild621_15

Fig. 15 Normalization Factor for Non-saturated and Saturated CTR vs. I_F

ILD621/ GB/ ILQ621/ GB



Vishay Semiconductors

Package Dimensions in Inches (mm)

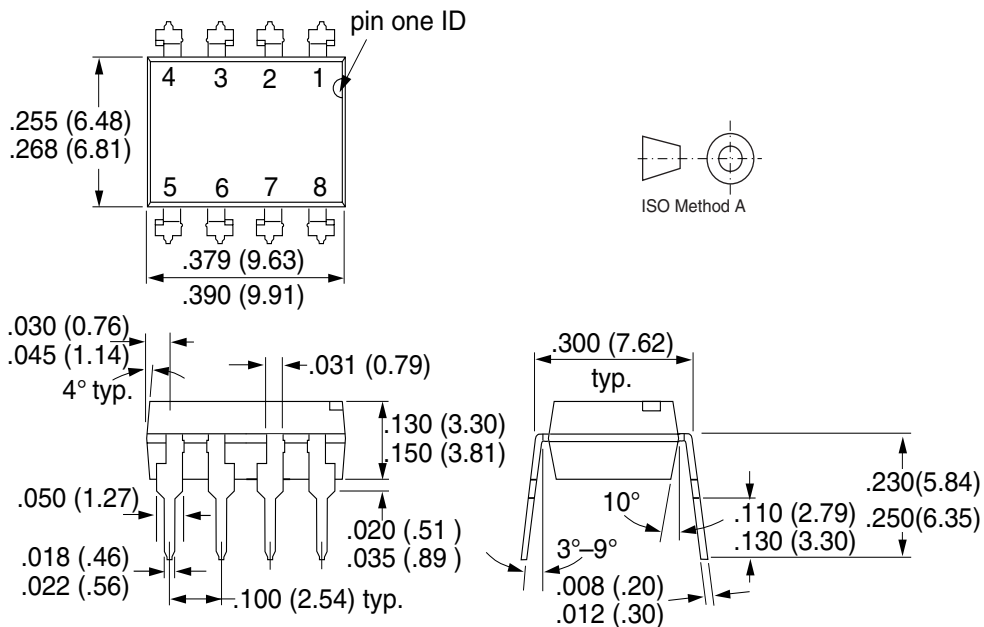

Package Dimensions in Inches (mm)

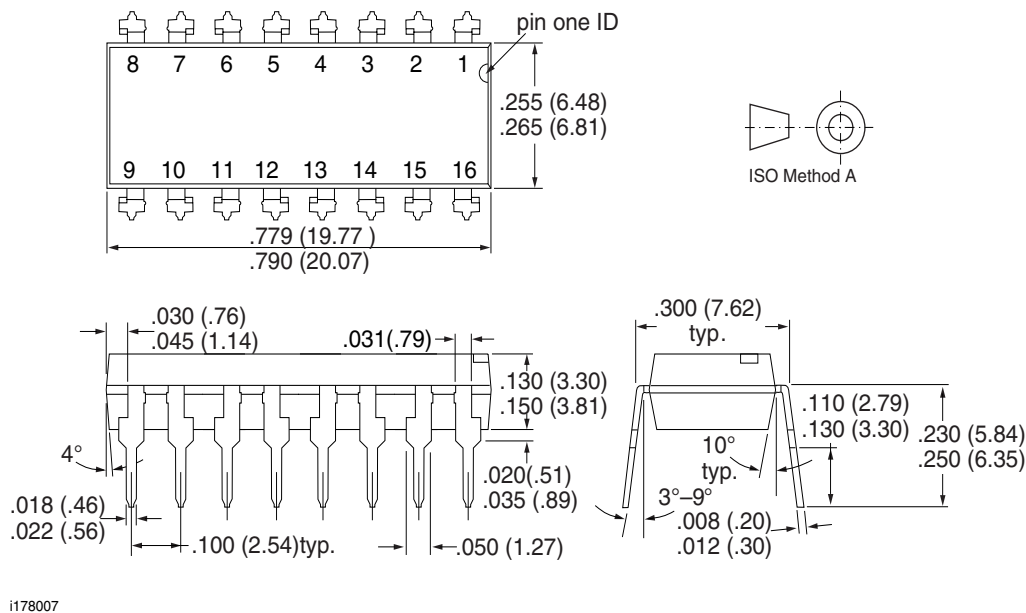

Option 6

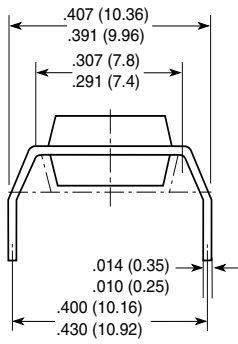

Option 7

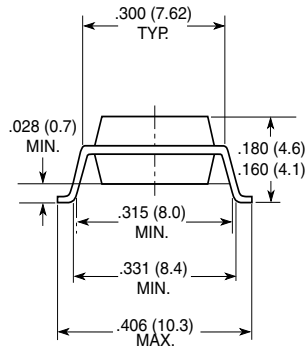

Option 9

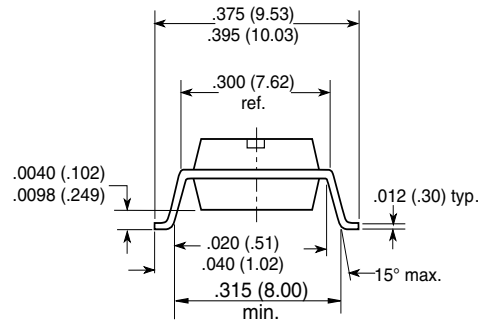

18450

Ozone Depleting Substances Policy Statement

It is the policy of **Vishay Semiconductor GmbH** to

1. Meet all present and future national and international statutory requirements.
2. Regularly and continuously improve the performance of our products, processes, distribution and operating systems with respect to their impact on the health and safety of our employees and the public, as well as their impact on the environment.

It is particular concern to control or eliminate releases of those substances into the atmosphere which are known as ozone depleting substances (ODSs).

The Montreal Protocol (1987) and its London Amendments (1990) intend to severely restrict the use of ODSs and forbid their use within the next ten years. Various national and international initiatives are pressing for an earlier ban on these substances.

Vishay Semiconductor GmbH has been able to use its policy of continuous improvements to eliminate the use of ODSs listed in the following documents.

1. Annex A, B and list of transitional substances of the Montreal Protocol and the London Amendments respectively
2. Class I and II ozone depleting substances in the Clean Air Act Amendments of 1990 by the Environmental Protection Agency (EPA) in the USA
3. Council Decision 88/540/EEC and 91/690/EEC Annex A, B and C (transitional substances) respectively.

Vishay Semiconductor GmbH can certify that our semiconductors are not manufactured with ozone depleting substances and do not contain such substances.

**We reserve the right to make changes to improve technical design
and may do so without further notice.**

Parameters can vary in different applications. All operating parameters must be validated for each customer application by the customer. Should the buyer use Vishay Semiconductors products for any unintended or unauthorized application, the buyer shall indemnify Vishay Semiconductors against all claims, costs, damages, and expenses, arising out of, directly or indirectly, any claim of personal damage, injury or death associated with such unintended or unauthorized use.

Vishay Semiconductor GmbH, P.O.B. 3535, D-74025 Heilbronn, Germany
Telephone: 49 (0)7131 67 2831, Fax number: 49 (0)7131 67 2423

This datasheet has been download from:

www.datasheetcatalog.com

Datasheets for electronics components.