

## High efficiency ultrafast diode

### Features

- Suited for SMPS
- Low losses
- Low forward and reverse recovery times
- High surge current capability
- High junction temperature
- Insulated version TOP3I:
  - Insulated voltage: 2500 V<sub>rms</sub>
  - Capacitance 12 pF

### Description

Dual center tab rectifier suited for switch mode power supplies and high frequency DC to DC converters.

Packaged in TO-220AB, TO-247, I<sup>2</sup>PAK, D<sup>2</sup>PAK, and TOP3I, this device is intended for use in low voltage, high frequency inverters, free wheeling and polarity protection

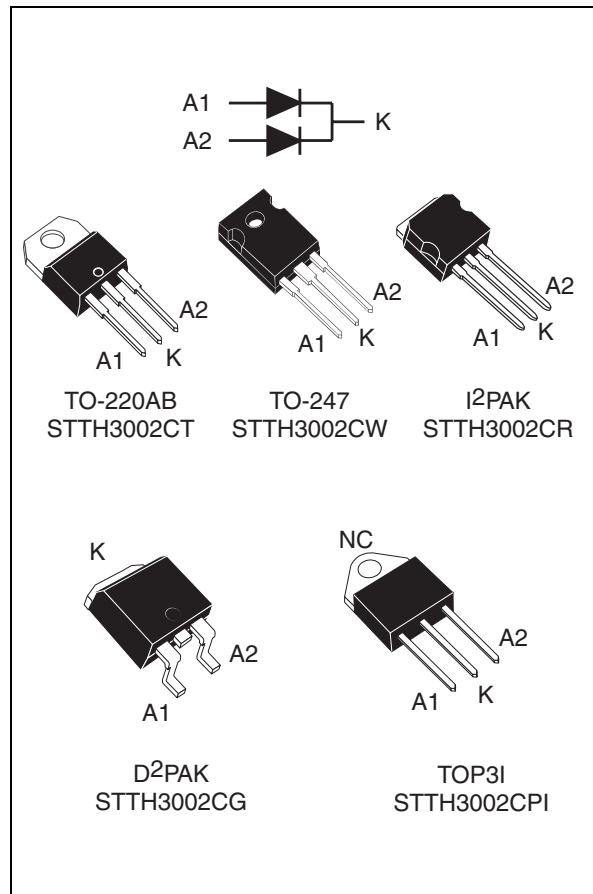

**Table 1. Device summary**

$I_{F(AV)}$	2 x 15A
$V_{RRM}$	200 V
$T_j(max)$	175 °C
$V_F (typ)$	0.75 V
$t_{rr} (typ)$	17 ns

# 1 Characteristics

**Table 2. Absolute ratings (limiting values at  $T_j = 25\text{ °C}$ , unless otherwise specified)**

Symbol	Parameter		Value	Unit	
$V_{RRM}$	Repetitive peak reverse voltage		200	V	
$I_{F(RMS)}$	RMS forward current		50	A	
$I_{F(AV)}$	Average forward current, $\delta = 0.5$	TO-220AB, TO-247, I <sup>2</sup> PAK, D <sup>2</sup> PAK	Per diode $T_c = 150\text{ °C}$	15	A
			Per device $T_c = 145\text{ °C}$	30	
		TOP3I	Per diode $T_c = 125\text{ °C}$	15	
			Per device $T_c = 105\text{ °C}$	30	
$I_{FSM}$	Surge non repetitive forward current	$t_p = 10\text{ ms}$ Sinusoidal	180	A	
$T_{stg}$	Storage temperature range		-65 to +175	°C	
$T_j$	Maximum operating junction temperature		175	°C	

**Table 3. Thermal parameters**

Symbol	Parameter		Value	Unit	
$R_{th(j-c)}$	Junction to case	TO-220AB, TO-247, I <sup>2</sup> PAK, D <sup>2</sup> PAK	Per diode	1.5	°C/W
			Total	1.0	
		TOP3I	Per diode	3.5	
			Total	2.3	
$R_{th(c)}$	Coupling	TO-220AB, TO-247, I <sup>2</sup> PAK, D <sup>2</sup> PAK	0.5		
		TOP3I	1.1		

When the two diodes 1 and 2 are used simultaneously:

$$\Delta T_j(\text{diode 1}) = P(\text{diode 1}) \times R_{th(j-c)} (\text{Per diode}) + P(\text{diode 2}) \times R_{th(c)}$$

**Table 4. Static electrical characteristics**

Symbol	Parameter	Test conditions	Min.	Typ	Max.	Unit	
$I_R^{(1)}$	Reverse leakage current	$T_j = 25\text{ }^\circ\text{C}$	$V_R = V_{RRM}$		20	$\mu\text{A}$	
		$T_j = 125\text{ }^\circ\text{C}$			10		125
$V_F^{(2)}$	Forward voltage drop	$T_j = 25\text{ }^\circ\text{C}$			1.05	V	
					$I_F = 30\text{ A}$		1.18
		$T_j = 150\text{ }^\circ\text{C}$			0.75		0.84
					$I_F = 30\text{ A}$		0.99

1. Pulse test:  $t_p = 5\text{ ms}$ ,  $\delta < 2\%$

2. Pulse test:  $t_p = 380\text{ }\mu\text{s}$ ,  $\delta < 2\%$

To evaluate the conduction losses use the following equation:

$$P = 0.69 \times I_{F(AV)} + 0.01 I_{F(RMS)}^2$$

**Table 5. Dynamic characteristics**

Symbol	Parameter	Test conditions	Min.	Typ	Max.	Unit
$t_{rr}$	Reverse recovery time	$I_F = 1\text{ A}$ , $dI_F/dt = 200\text{ A}/\mu\text{s}$ , $V_R = 30\text{ V}$ , $T_j = 25\text{ }^\circ\text{C}$		17	22	ns
$I_{RM}$	Reverse recovery current	$I_F = 15\text{ A}$ , $dI_F/dt = 200\text{ A}/\mu\text{s}$ , $V_R = 160\text{ V}$ , $T_j = 125\text{ }^\circ\text{C}$		6	7.8	A
$t_{fr}$	Forward recovery time	$I_F = 15\text{ A}$ , $dI_F/dt = 200\text{ A}/\mu\text{s}$ $V_{FR} = 1.1 \times V_{Fmax}$ , $T_j = 25\text{ }^\circ\text{C}$			110	ns
$V_{FP}$	Forward recovery voltage	$I_F = 15\text{ A}$ , $dI_F/dt = 200\text{ A}/\mu\text{s}$ , $T_j = 25\text{ }^\circ\text{C}$		2.5		V

**Figure 1. Peak current versus duty cycle (per diode)**

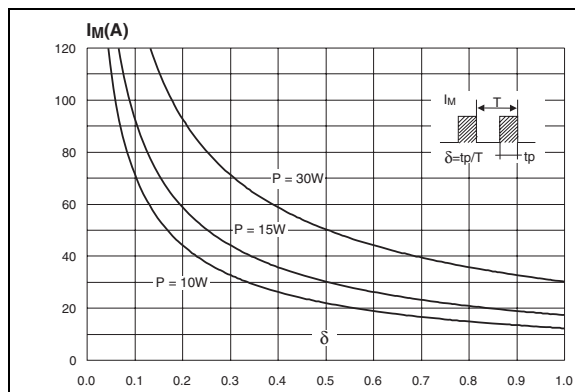

**Figure 2. Forward voltage drop versus forward current (typical values, per diode)**

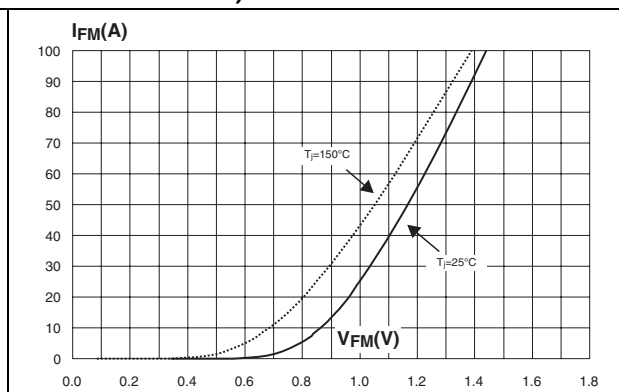

**Figure 3. Forward voltage drop versus forward current (maximum values, per diode)**

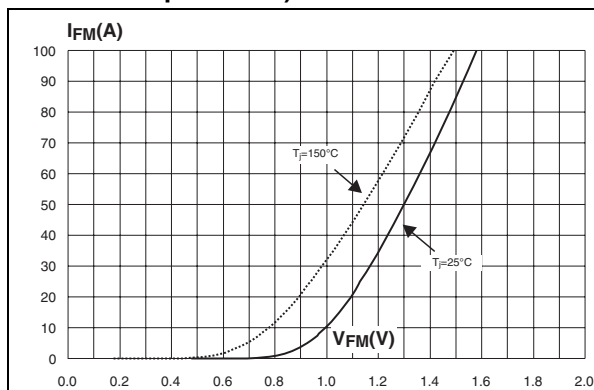

**Figure 4. Relative variation of thermal impedance junction to case versus pulse duration**

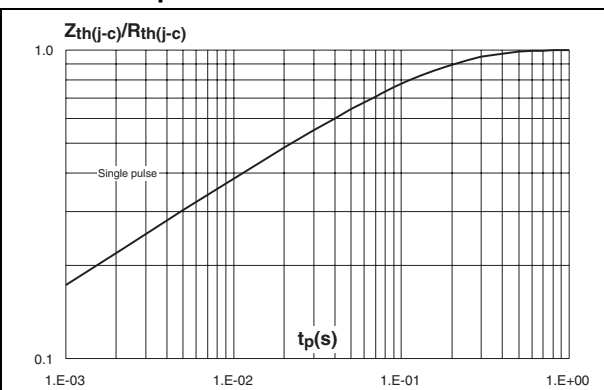

**Figure 5. Junction capacitance versus reverse applied voltage (typical values, per diode)**

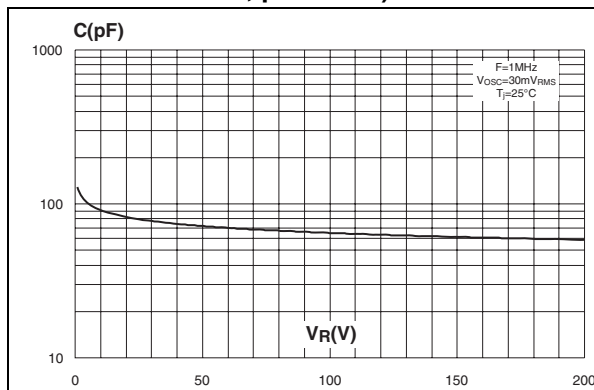

**Figure 6. Reverse recovery charges versus  $dI_F/dt$  (typical values, per diode)**

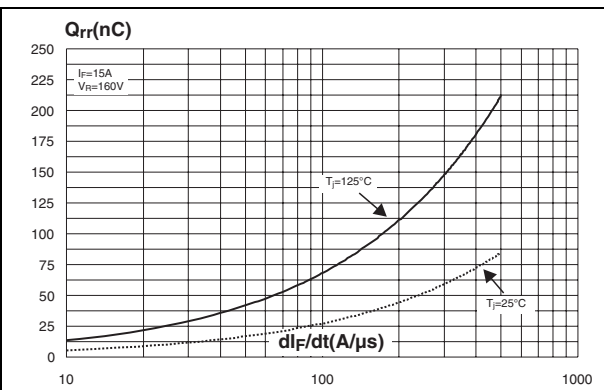

**Figure 7. Reverse recovery time versus  $dI_F/dt$  (typical values, per diode)**

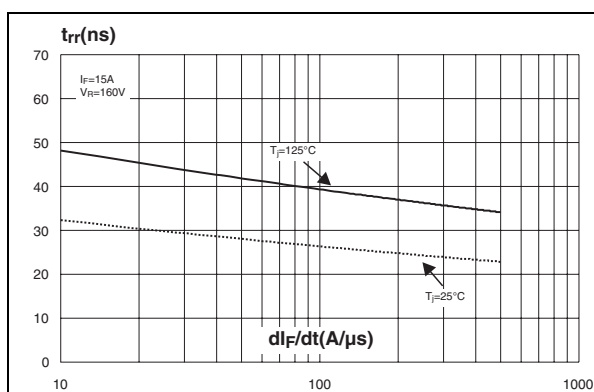

**Figure 8. Peak reverse recovery current versus  $dI_F/dt$  (typical values, per diode)**

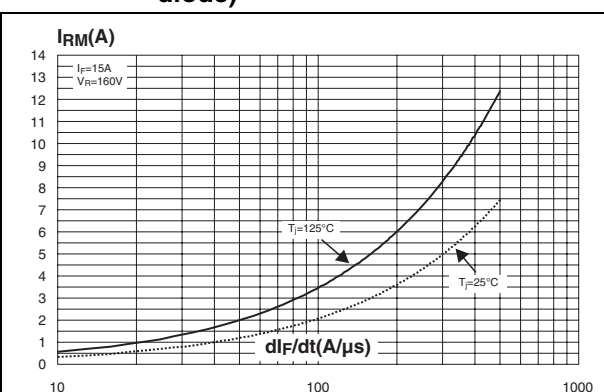

Figure 9. Dynamic parameters versus junction temperature

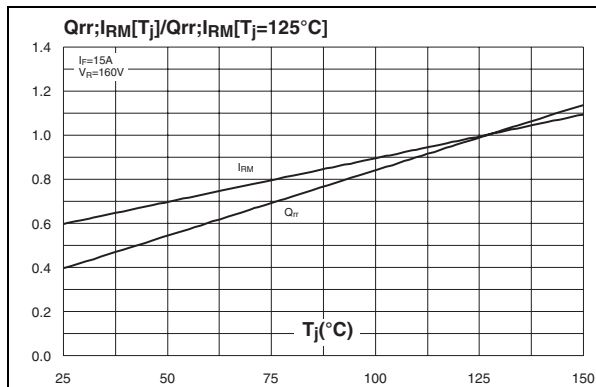
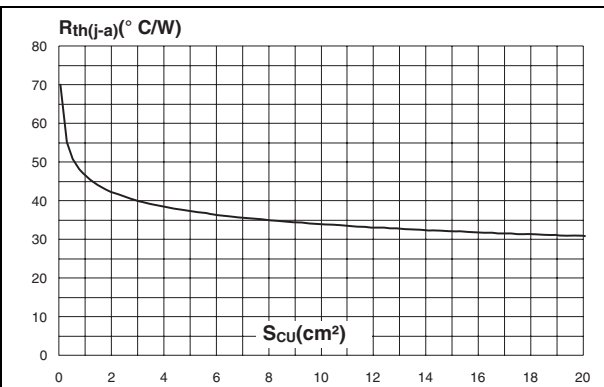
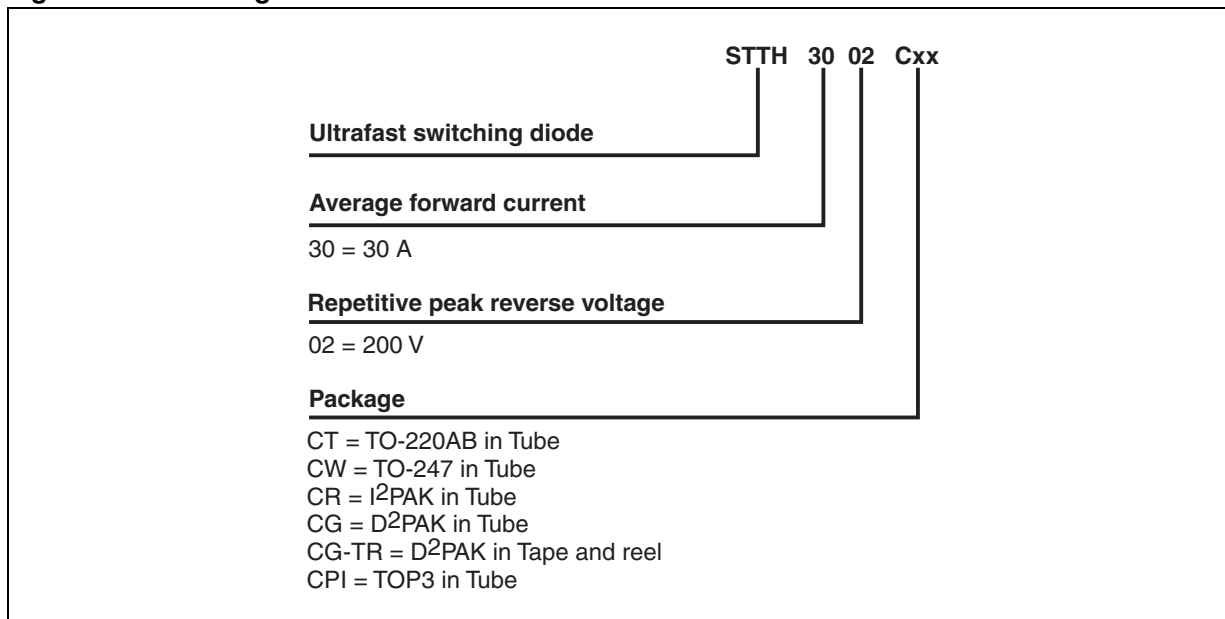

Figure 10. Thermal resistance junction to ambient versus copper surface under each tab (Epoxy printed circuit board FR4, e<sub>CU</sub> = 35 μm) for D<sup>2</sup>PAK



## 2 Ordering information scheme

Figure 11. Ordering information scheme



### 3 Package information

- Epoxy meets UL94, V0
- Cooling method: by conduction (C)
- Recommended torque values: TO-220AB 0.4 to 0.6 N·m, TO-247 0.55 N·m (1.0 N·m maximum), TOP31 0.9 to 1.2 N·m

In order to meet environmental requirements, ST offers these devices in ECOPACK® packages. These packages have a lead-free second level interconnect. The category of second level interconnect is marked on the package and on the inner box label, in compliance with JEDEC Standard JESD97. The maximum ratings related to soldering conditions are also marked on the inner box label. ECOPACK is an ST trademark. ECOPACK specifications are available at [www.st.com](http://www.st.com).

**Table 6. TO-220AB dimensions**

Ref.	DIMENSIONS					
	Millimeters			Inches		
	Min.	Typ	Max.	Min.	Typ	Max.
A	15.20		15.90	0.598		0.625
a1		3.75			0.147	
a2	13.00		14.00	0.511		0.551
B	10.00		10.40	0.393		0.409
b1	0.61		0.88	0.024		0.034
b2	1.23		1.32	0.048		0.051
C	4.40		4.60	0.173		0.181
c1	0.49		0.70	0.019		0.027
c2	2.40		2.72	0.094		0.107
e	2.40		2.70	0.094		0.106
F	6.20		6.60	0.244		0.259
ØI	3.75		3.85	0.147		0.151
I4	15.80	16.40	16.80	0.622	0.646	0.661
L	2.65		2.95	0.104		0.116
I2	1.14		1.70	0.044		0.066
I3	1.14		1.70	0.044		0.066
M		2.60			0.102	

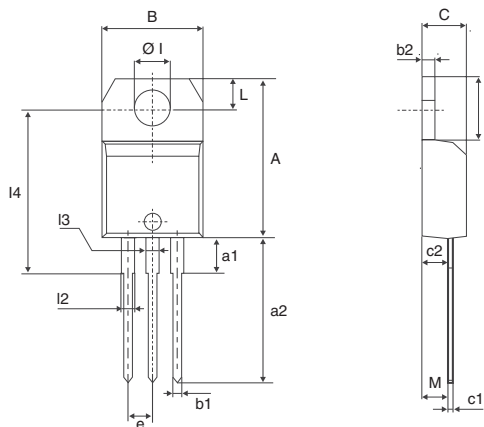

Table 7. TO-247 dimensions

Ref.	DIMENSIONS					
	Millimeters			Inches		
	Min.	Typ	Max.	Min.	Typ	Max.
A	4.85		5.15	0.191		0.203
D	2.20		2.60	0.086		0.102
E	0.40		0.80	0.015		0.031
F	1.00		1.40	0.039		0.055
F1		3.00			0.118	
F2		2.00			0.078	
F3	2.00		2.40	0.078		0.094
F4	3.00		3.40	0.118		0.133
G		10.90			0.429	
H	15.45		15.75	0.608		0.620
L	19.85		20.15	0.781		0.793
L1	3.70		4.30	0.145		0.169
L2		18.50			0.728	
L3	14.20		14.80	0.559		0.582
L4		34.60			1.362	
L5		5.50			0.216	
M	2.00		3.00	0.078		0.118
V		5°			5°	
V2		60°			60°	
Dia.	3.55		3.65	0.139		0.143

Table 8. I<sup>2</sup>PAK dimensions

Ref.	DIMENSIONS			
	Millimeters		Inches	
	Min.	Max.	Min.	Max.
A	4.40	4.60	0.173	0.181
A1	2.40	2.72	0.094	0.107
b	0.61	0.88	0.024	0.035
b1	1.14	1.70	0.044	0.067
c	0.49	0.70	0.019	0.028
c2	1.23	1.32	0.048	0.052
D	8.95	9.35	0.352	0.368
e	2.40	2.70	0.094	0.106
e1	4.95	5.15	0.195	0.203
E	10	10.40	0.394	0.409
L	13	14	0.512	0.551
L1	3.50	3.93	0.138	0.155
L2	1.27	1.40	0.050	0.055

Table 9. TOP3I dimensions

Ref.	DIMENSIONS			
	Millimeters		Inches	
	Min.	Max.	Min.	Max.
A	4.4	4.6	0.173	0.181
B	1.45	1.55	0.057	0.061
C	14.35	15.60	0.565	0.614
D	0.5	0.7	0.020	0.028
E	2.7	2.9	0.106	0.114
F	15.8	16.5	0.622	0.650
G	20.4	21.1	0.815	0.831
H	15.1	15.5	0.594	0.610
J	5.4	5.65	0.213	0.222
K	3.4	3.65	0.134	0.144
ØL	4.08	4.17	0.161	0.164
P	1.20	1.40	0.047	0.055
R	4.60 Typ.		0.181 Typ.	



Table 10. D<sup>2</sup>PAK dimensions

Ref.	DIMENSIONS			
	Millimeters		Inches	
	Min.	Max	Min.	Max.
A	4.40	4.60	0.173	0.181
A1	2.49	2.69	0.098	0.106
A2	0.03	0.23	0.001	0.009
B	0.70	0.93	0.027	0.037
B2	1.14	1.70	0.045	0.067
C	0.45	0.60	0.017	0.024
C2	1.23	1.36	0.048	0.054
D	8.95	9.35	0.352	0.368
E	10.00	10.40	0.393	0.409
G	4.88	5.28	0.192	0.208
L	15.00	15.85	0.590	0.624
L2	1.27	1.40	0.050	0.055
L3	1.40	1.75	0.055	0.069
M	2.40	3.20	0.094	0.126
R	0.40 typ.		0.016 typ.	
V2	0°	8°	0°	8°

Figure 12. D<sup>2</sup>PAK footprint (dimensions in mm)

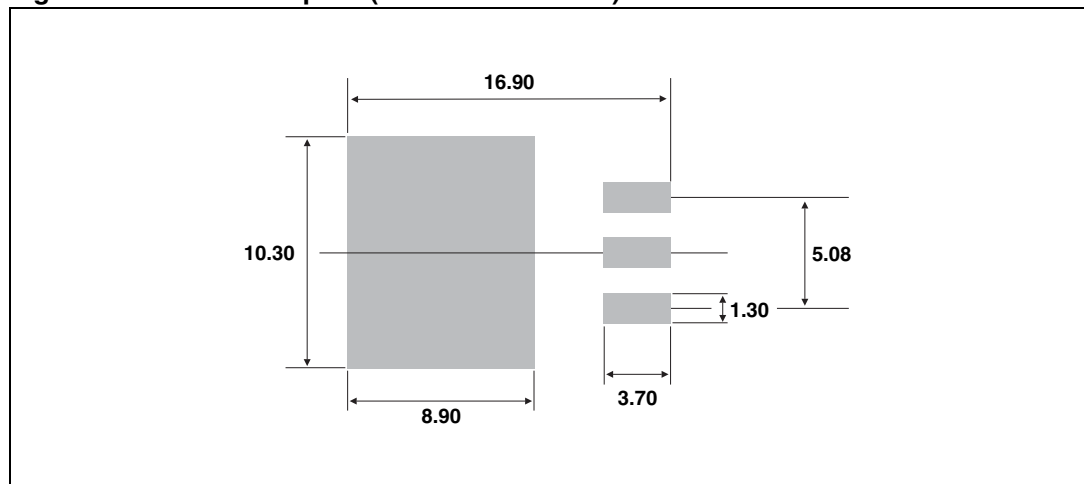

## 4 Ordering information

**Table 11. Ordering information**

Order code	Marking	Package	Weight	Base qty	Delivery mode
STTH3002CT	STTH3002C	TO-220AB	2.23 g	50	Tube
STTH3002CW	STTH3002C	TO-247	4.46 g	30	Tube
STTH3002CR	STTH3002C	I <sup>2</sup> PAK	1.49 g	50	Tube
STTH3002CG	STTH3002C	D <sup>2</sup> PAK	1.48 g	50	Tube
STTH3002CG-TR	STTH3002C	D <sup>2</sup> PAK	1.48 g	1000	Tape and reel
STTH3002CPI	STTH3002C	TOP3I	4.7 g	30	Tube

## 5 Revision history

**Table 12. Document revision history**

Date	Revision	Description of changes
Feb-2004	1	First issue
05-Apr-2006	2	Reformatted to current template. Package TOP3I added.
10-May-2006	3	Replace illustrations for TO-247 and I <sup>2</sup> PAK dimensions.
25-Aug-2008	4	Reformatted to current standards. Updated ECOPACK statement. Updated torque values and TO-247 dimension illustration in <a href="#">Section 3</a> .

**Please Read Carefully:**

Information in this document is provided solely in connection with ST products. STMicroelectronics NV and its subsidiaries ("ST") reserve the right to make changes, corrections, modifications or improvements, to this document, and the products and services described herein at any time, without notice.

All ST products are sold pursuant to ST's terms and conditions of sale.

Purchasers are solely responsible for the choice, selection and use of the ST products and services described herein, and ST assumes no liability whatsoever relating to the choice, selection or use of the ST products and services described herein.

No license, express or implied, by estoppel or otherwise, to any intellectual property rights is granted under this document. If any part of this document refers to any third party products or services it shall not be deemed a license grant by ST for the use of such third party products or services, or any intellectual property contained therein or considered as a warranty covering the use in any manner whatsoever of such third party products or services or any intellectual property contained therein.

**UNLESS OTHERWISE SET FORTH IN ST'S TERMS AND CONDITIONS OF SALE ST DISCLAIMS ANY EXPRESS OR IMPLIED WARRANTY WITH RESPECT TO THE USE AND/OR SALE OF ST PRODUCTS INCLUDING WITHOUT LIMITATION IMPLIED WARRANTIES OF MERCHANTABILITY, FITNESS FOR A PARTICULAR PURPOSE (AND THEIR EQUIVALENTS UNDER THE LAWS OF ANY JURISDICTION), OR INFRINGEMENT OF ANY PATENT, COPYRIGHT OR OTHER INTELLECTUAL PROPERTY RIGHT.**

**UNLESS EXPRESSLY APPROVED IN WRITING BY AN AUTHORIZED ST REPRESENTATIVE, ST PRODUCTS ARE NOT RECOMMENDED, AUTHORIZED OR WARRANTED FOR USE IN MILITARY, AIR CRAFT, SPACE, LIFE SAVING, OR LIFE SUSTAINING APPLICATIONS, NOR IN PRODUCTS OR SYSTEMS WHERE FAILURE OR MALFUNCTION MAY RESULT IN PERSONAL INJURY, DEATH, OR SEVERE PROPERTY OR ENVIRONMENTAL DAMAGE. ST PRODUCTS WHICH ARE NOT SPECIFIED AS "AUTOMOTIVE GRADE" MAY ONLY BE USED IN AUTOMOTIVE APPLICATIONS AT USER'S OWN RISK.**

Resale of ST products with provisions different from the statements and/or technical features set forth in this document shall immediately void any warranty granted by ST for the ST product or service described herein and shall not create or extend in any manner whatsoever, any liability of ST.

ST and the ST logo are trademarks or registered trademarks of ST in various countries.

Information in this document supersedes and replaces all information previously supplied.

The ST logo is a registered trademark of STMicroelectronics. All other names are the property of their respective owners.

© 2008 STMicroelectronics - All rights reserved

STMicroelectronics group of companies

Australia - Belgium - Brazil - Canada - China - Czech Republic - Finland - France - Germany - Hong Kong - India - Israel - Italy - Japan - Malaysia - Malta - Morocco - Singapore - Spain - Sweden - Switzerland - United Kingdom - United States of America

[www.st.com](http://www.st.com)