

**3285**

**CLAMP ON**

**AC/DC HiTESTER**

---

**INSTRUCTION MANUAL**



# Contents

Introduction .....	i
Shipping Check .....	ii
Safety .....	iii
Attentions During Use .....	viii
Organization of This Manual .....	xii
<b>Chapter 1 Product Outline .....</b>	<b>1</b>
1.1 Product Outline .....	1
1.2 Features .....	2
1.3 Parts and Functions .....	3
1.4 Flowchart of Key Operations .....	9
1.4.1 Current Measurements Mode .....	9
1.4.2 Voltage Measurements Mode .....	10
1.4.3 Frequency Measurements Mode .....	11
1.5 Modes .....	12
<b>Chapter 2 Measurement Procedure .....</b>	<b>15</b>
2.1 Preparations .....	15
2.2 Current Measurement .....	16
2.2.1 Measuring DC Current (DC A) .....	16
2.2.2 Measuring AC Current (AC A) .....	17
2.2.3 Measuring AC/DC Current (AC+DC A) .....	18
2.2.4 Peak Hold Measurement .....	20
2.2.5 Output Function .....	21
2.3 Voltage Measurement .....	26
2.3.1 Measuring DC Voltage (DC V) .....	26
2.3.2 Measuring AC Voltage (AC V) .....	27
2.3.3 Measuring AC/DC Voltage (AC+DC V) .....	28
2.3.4 Peak Hold Measurement .....	29

2.4	Frequency Measurement .....	30
2.4.1	Frequency Measurement in Current Mode .....	30
2.4.2	Frequency Measurement in Voltage Mode .....	31
2.4.3	Output Function For Frequency .....	32
2.5	Auto-Zero-Adjustment/Zero-Cancel Correction Function .....	34
2.5.1	Auto-Zero-Adjustment Function .....	34
2.5.2	Zero-Cancel Correction Function .....	35
2.6	Data Hold Function HOLD .....	35
2.7	Alteration of Counter Updates .....	36
2.7.1	SLOW mode .....	36
2.7.2	FAST mode .....	36
2.8	Recording Function REC .....	37
2.9	Auto Power-Off Function APS .....	40
2.10	Battery Low Warning  .....	41
2.11	Beep Tone .....	41
Chapter 3	Specifications .....	43
3.1	Measurement Specifications .....	43
3.1.1	Current Measurement Specifications .....	43
3.1.2	Voltage Measurement Specifications .....	48
3.2	General Specifications .....	49
Chapter 4	Battery Replacement .....	53
Chapter 5	AC Adapter (Optional) .....	55
Chapter 6	Attaching The Hand Strap .....	57
Chapter 7	Troubleshooting .....	59
Chapter 8	Service .....	65

## **Introduction**

Thank you for purchasing the HIOKI "3285 CLAMP ON AC/DC HiTESTER." To obtain maximum performance from the instrument/ device/ product, please read this manual first, and keep it handy for future reference.

### **Request**

We have tried to bring this manual as close to perfection as we could achieve. If perchance you find any unclear portions, mistakes, omissions, or the like, we would be most obliged if you could please notify us of them via any HIOKI agent, or directly.

---

## Shipping Check

When the unit is delivered, check and make sure that it has not been damaged in transit. In particular, check the accessories, panel switches, keys, and terminals.

If the unit is damaged, or fails to operate according to the specifications, contact your dealer or HIOKI representative.

### Check the 3285 Unit and the Supplied Accessories

Main unit

3285 CLAMP ON AC/DC HiTESTER

Supplied accessories

9345 CARRYING CASE	1
9207-10 TEST LEAD (red and black)	1
Hand Strap	1
6F22(006P)	1
Instruction manual	1

### Options

9094 OUTPUT CORD

9445-02 AC ADAPTER

(SA10-0910N, SINO-AMERICAN)

9445-03 AC ADAPTER (EU)

(SA10-0910G, SINO-AMERICAN)

---





## Safety

 **DANGER**

**This instrument is designed to comply with IEC 61010 Safety Standards, and has been thoroughly tested for safety prior to shipment. However, mishandling during use could result in injury or death, as well as damage to the instrument. Be certain that you understand the instructions and precautions in the manual before use. We disclaim any responsibility for accidents or injuries not resulting directly from instrument defects.**









This manual contains information and warnings essential for safe operation of the instrument and for maintaining it in safe operating condition. Before using it, be sure to carefully read the following safety precautions.

The following symbols in this manual indicate the relative importance of cautions and warnings.

	Indicates that incorrect operation presents extreme danger of accident resulting in death or serious injury to the user.
	Indicates that incorrect operation presents a significant hazard that could result in serious injury or death to the user.
	Indicates that incorrect operation presents a possibility of injury to the user or damage to the instrument.
	Indicates advisory items related to performance or correct operation of the instrument.



## Safety Symbols

	<p>The  symbol printed on the instrument indicates that the user should refer to a corresponding topic in the manual (marked with the  symbol) before using the relevant function.</p> <p>In the manual, the  symbol indicates particularly important information that the user should read before using the instrument.</p>
	<p>Indicates AC (Alternating Current).</p>
	<p>Indicates DC (Direct Current).</p>
	<p>Indicates both DC (Direct Current) and AC (Alternating Current).</p>
	<p>Indicates a device which is double-insulated.</p>
	<p>Indicates that the instrument may be connected to or disconnected from a live circuit.</p>

f.s. (maximum display or scale value, or length of scale)

Signifies the maximum display (scale) value or the length of the scale (in cases where the scale consists of unequal increments or where the maximum value cannot be defined).

In general, this is the range value (the value written on the range selector or equivalent) currently in use.

rdg. (displayed or indicated value)

Signifies the value actually being measured, i.e., the value that is currently indicated or displayed by the measuring instrument.

dgt. (resolution)

Signifies the smallest display unit on a digital measuring instrument, i.e., the value displayed when the last digit on the digital display is "1".

## **Measurement categories (Overvoltage categories)**

This instrument complies with CAT III safety requirements.

To ensure safe operation of measurement instruments, IEC 61010 establishes safety standards for various electrical environments, categorized as CAT I to CAT IV, and called measurement categories. These are defined as follows.

CAT I : Secondary electrical circuits connected to an AC electrical outlet through a transformer or similar device.

CAT II : Primary electrical circuits in equipment connected to an AC electrical outlet by a power cord (portable tools, household appliances, etc.)

CAT III: Primary electrical circuits of heavy equipment (fixed installations) connected directly to the distribution panel, and feeders from the distribution panel to outlets.

CAT IV: The circuit from the service drop to the service entrance, and to the power meter and primary overcurrent protection device (distribution panel).

Higher-numbered categories correspond to electrical environments with greater momentary energy. So a measurement device designed for CAT III environments can endure greater momentary energy than a device designed for CAT II.

Using a measurement instrument in an environment designated with a higher-numbered category than that for which the instrument is rated could result in a severe accident, and must be carefully avoided. Never use a CAT I measuring instrument in CAT II, III, or IV environments.

The measurement categories comply with the Overvoltage Categories of the IEC60664 Standards.

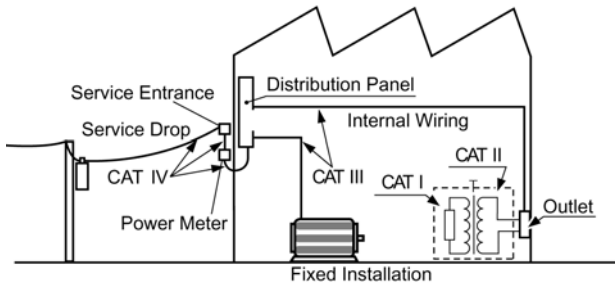



## Attentions During Use

Follow these precautions to ensure safe operation and to obtain the full benefits of the various functions.

### DANGER

- **Use clamp testers only on power lines up to 600 Vrms, to avoid short-circuits and accidents that could result in injury or death.**
- **Always connect the clamp sensor to the secondary side of a breaker. On the secondary side of a breaker, even if the lines are shorted the breaker can trip and prevent an accident. On the primary side, however, the current capacity may be large, and in the event of a short-circuits there may be a serious accident.**
- **When using an AC adapter, use only the specified HIOKI model 9445-02 (SA10-0910N, SINO-AMERICAN) or 9445-03 (for EU) (SA10-0910G, SINO-AMERICAN).**

**⚠ WARNING**

- To avoid electric shock, do not allow the product to get wet, and do not use it when your hands are wet.
- To avoid electric shock when measuring live lines, wear appropriate protective gear, such as insulated rubber gloves, boots and a safety helmet.
- During current measurement, to avoid an electric shock accident, do not connect the test leads to the product.
- Do not input voltage exceeding 600 Vrms (1000 V max.).
- To avoid electric shock when replacing the batteries, first disconnect the clamp portion from the object to be measured. Also, before using the product after replacing the batteries, replace the cover and screw.
- When replacing the batteries, be sure to insert them with the correct polarity. Otherwise, poor performance or damage from battery leakage could result.
- To avoid the possibility of explosion, do not short circuit, disassemble or incinerate batteries.
- Handle and dispose of batteries in accordance with local regulations.
- Do not use the instrument where it may be exposed to corrosive or combustible gases. The instrument may be damaged or cause an explosion.

 **CAUTION**

- This is a precision instrument: do not clamp any foreign objects in the end of the clamp core, or insert anything in the core gap.
- To avoid damage to the product, protect it from vibration or shock during transport and handling, and be especially careful to avoid dropping. Do not exert excessive pressure on the clamp sensor or attempt to wedge the sensor into a tight spot for measurement.
- Before using the product the first time, verify that it operates normally to ensure that no damage occurred during storage or shipping. If you find any damage, contact your dealer or HIOKI representative.
- To avoid damage to the product, do not exceed the maximum input current rating, which depends on the frequency of the current being measured (see Fig.4 of Chapter 3) Be careful about the evolution of heat, when the input frequency is high.
- Do not use the product if the battery is exhausted (when the  mark lights in the display area). Be sure to replace the exhausted battery with a new one.
- When replacing the battery, make sure that the metal battery snap fitting is firmly connected. If the metal fitting is loose, adjust it and recheck the connection. If it isn't connected securely, the power may not be turned on, and a power may be turned off during the use.
- Adjustments and repairs should be made only by technically qualified personnel.

**⚠ CAUTION**

- For the inside memory protection, make sure the power is turned off before plugging in or unplugging the AC adapter.
- This product is designed for indoor use, and operates reliably from 0°C to 40°C.
- Do not store or use the product where it could be exposed to direct sunlight, high temperature or humidity, or condensation. Under such conditions, the product may be damaged and insulation may deteriorate so that it no longer meets specifications.

**NOTE**

- Accurate measurement may be impossible in locations subject to strong external magnetic fields, such as transformers and high-current conductors, or in locations subject to strong external electric fields, such as radio transmission equipment.
- Gently wipe dirt from the surface of the unit with a soft cloth moistened with a small amount of water or mild detergent.  
Do not try to clean the unit using cleaners containing organic solvents such as benzene, alcohol, acetone, ether, ketones, thinners, or gasoline. They may cause discoloration or damage.
- When not in use for a long time, to prevent possible corrosion caused by battery leakage, remove the batteries before storage.

## **Organization of This Manual**

### **Chapter 1**

#### **Product Outline**

Explains the parts and functions of the unit.

### **Chapter 2**

#### **Measurement Procedure**

Explains how to use the 3285 for measurement.

### **Chapter 3**

#### **Specifications**

Lists the specifications of the 3285 CLAMP ON AC/DC HiTESTER.

### **Chapter 4**

#### **Battery Replacement**

Explains how to replace the battery used to power the 3285.

### **Chapter 5**

#### **AC Adapter (Optional)**

Explains how to use the AC adapter.

### **Chapter 6**

#### **Attaching the Hand Strap**

Explains how to attach the hand strap, for easy handling of the unit in the field.

### **Chapter 7**

#### **Troubleshooting**

Describes how to check before requesting service.

### **Chapter 8**

#### **Service**

Explains how to get the unit serviced.



---

# Chapter 1

## Product Outline

---

---

### 1.1 Product Outline

The 3285 CLAMP ON AC/DC HiTESTER makes it possible to measure DC, AC or AC+DC current in live power lines without tapping into or connecting the lines. Using a one-chip microprocessor, the tester provides many functions, including an automatic zero adjust function that changes a troublesome task into a one-touch operation. An AC adapter connection terminal and an output terminal are equipped so that you are able to measure by connecting to other instruments such as recorders.

## 1.2 Features

- **A multi-function microcomputer**  
The built-in microcomputer offers various functions in a compact form.
- **Display of true rms values**  
The true rms value conversion circuit allows accurate measurement of currents with distorted waveforms.
- **Measurement for AC/DC**  
The unit permits measurement of AC superimposed on DC, as well as measurement of half- and full-wave rectification.
- **Peak measurement**  
Allows measurement of peak hold values for either voltage or current. Transitional peak values can also be measured.
- **REC function**  
Displays the maximum and minimum measured values.
- **Output terminal**  
You can record current or frequency by connecting a recorder or an oscilloscope to the built-in output terminal.
  - Current (Record output: REC, Waveform output: MON)
  - Frequency (Record output: REC)
- **Dual-power source**  
The unit operates on either a battery power or an AC power source.

## 1.3 Parts and Functions

Top and Side View

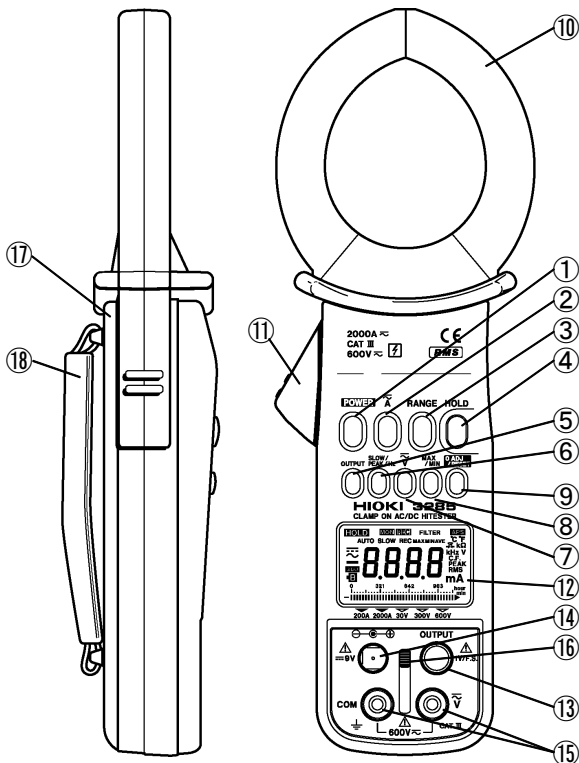

① **POWER**

- Used to turn power on/off
- To disable the auto power-off function, hold **HOLD** and press **POWER**, when you turn power on.

② **↔** key

- Switches current modes as follow.

③ **RANGE**

- Switches between auto and manual ranges in measurements of current, voltage, or frequency.
- Switches manual ranges.
- Displays a cursor on the bar graph to show the selected range.
- The current ranges are 200 A and 2000 A. The voltage ranges are 30 V, 300 V and 600 V. The frequency ranges are 10 Hz, 100 Hz and 1000 Hz.

④ **HOLD**

- Used to suspend or inactivate the screen-updating function.
- To disable the auto power-off function when powering on, hold **HOLD** and press **POWER**.

⑤ **OUTPUT**

- Allows voltage output during current measurement or frequency measurement in a current mode.
- The auto power-off function is inactivated.

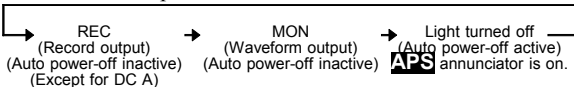

- You can find how much the battery power remains on the bar graph, when you press **OUTPUT** in a current mode.

**⑥ SLOW/PEAK/Hz**

- **SLOW** slows down screen updating (once per three seconds).
- **FAST** speeds up screen updating (four times per second). There isn't an annunciator "**FAST**". Instead, the unit symbol blinks.
- **PEAK** measures peak values (Peak Hold).
- **Hz** measures frequency (in AC or AC+DC mode).

**⑦  $\tilde{V}$** 

- Switches voltage modes as follows.

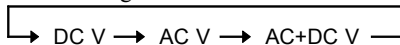
**⑧ MAX/MIN**

- Displays the maximum value (**MAX**), the minimum value (**MIN**), or the average value (**AVE**) of the maximum and minimum values for the recording (**REC**) function.
- **MAX** displays the maximum measured value after the **REC** function is activated.
- **MIN** displays the minimum measured value after the **REC** function is activated.
- **AVE** displays the average value of the maximum and minimum measured values after the **REC** function is activated.
- The auto power-off function is disabled in the **REC** function.

**⑨ 0ADJ/RESET**

- Performs auto-zero-adjustment in DC A, AC+DC A and DC V modes.
- Resets data when measuring peak values. Reset all the data in a **REC** function.
- If zero is not indicated under no input in the AC A, AC+DC A, AC V or AC+DC V modes, press **HOLD**, then press **0ADJ/RESET** to perform a zero-cancel correction.

**⑩ Clamp sensor**



- To measure current, open the top ends of the clamp sensor by gripping the lever ⑪. Then position the conductor to be measured at the center of the clamp sensor and firmly close the clamp sensor.

**⑪ Lever**

- Used to open and close the clamp sensor.

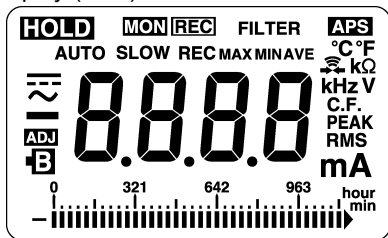
## ⑫ Display (LCD)



-  Direct Current (DC)
-  Alternating Current (AC)
-  Alternating Current and Direct Current (AC+DC)
- ADJ** Auto-zero-adjustment or zero-cancel correction function is active
- B** Battery low warning
- HOLD** Data hold function
- MON** Waveform output (AC) is active
- REC** Recording output (DC) is active
- APS** Auto power off function
- AUTO** Auto-range
- SLOW** Counter update once every 3 seconds
- REC** Record function
- MAX** Maximum value
- MIN** Minimum value
- AVE** Average value =  $(\mathbf{MAX} + \mathbf{MIN}) / 2$
- Hz** Frequency
- V** Voltage
- PEAK** Wave peak value
- RMS** True root mean square value

<b>A</b>	Current
<b>hour</b>	1 hour/segment (bar graph)
<b>min</b>	1 minute/segment (bar graph)
<b>▶</b>	Input over (bar graph)

⑬ **Output terminal**

Connected to the optional 9094 OUTPUT CORD to provide output during a current measurement or a frequency measurement in a current mode.

⑭ **AC adapter connection terminal**

Connected to the optional 9445-02 or 9445-03 AC ADAPTER to perform measurements for no battery or a long term measurement.

⑮ **Voltage measurement terminal (V and COM terminals)**

Connected to the 9207-10 TEST LEAD (red and black, supplied with the unit) to measure voltage.

⑯ **Slide knob**

Slide up to use the voltage measurement terminal or slide down to use the output terminal or AC adapter connection terminal. Move until a click is heard.

⑰ **Back case**

To replace the battery, remove the two screws.

⑱ **Hand strap**

Attach to get a better grip on the unit.



## 1.4 Flowchart of Key Operations

### 1.4.1 Current Measurements Mode

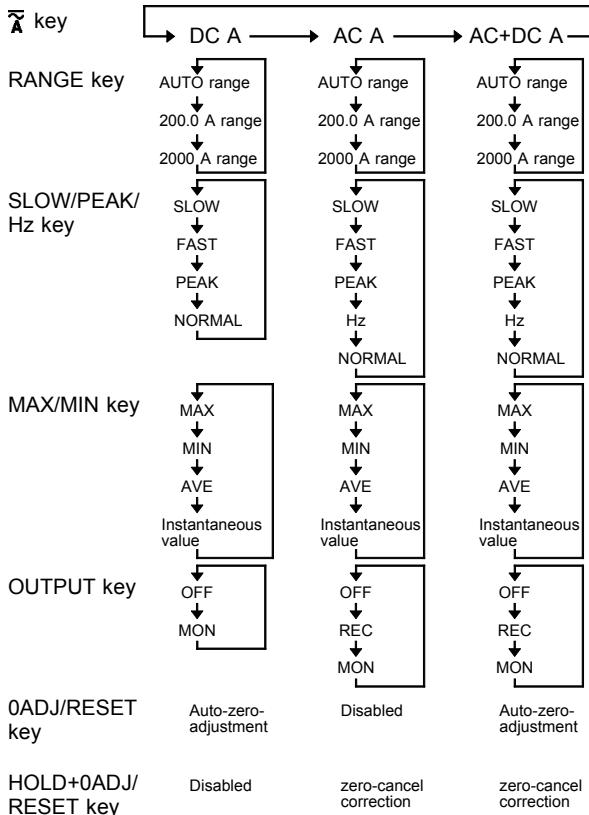

\* Neither "FAST" or "NORMAL" annunciator is on the display.

## 1.4.2 Voltage Measurements Mode

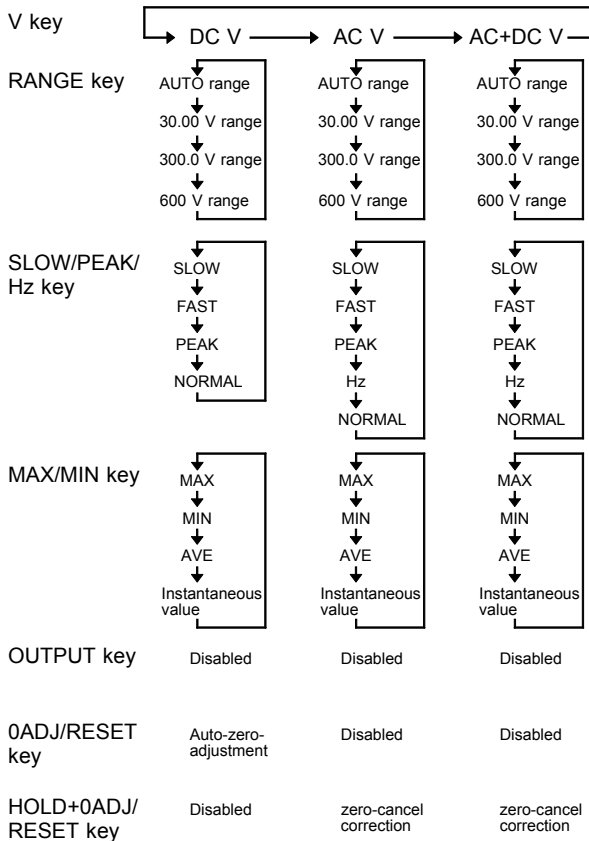

\* Neither "FAST" or "NORMAL" annunciator is on the display.

### 1.4.3 Frequency Measurements Mode

Current (AC A, AC+DC A) mode

Voltage (AC V, AC+DC V) mode

SLOW/PEAK/  
Hz key

→ SLOW → FAST → PEAK → Hz → NORMAL →

Current mode

Voltage mode

RANGE key

AUTO range  
↓  
10.00 Hz range  
↓  
100.0 Hz range  
↓  
1000 Hz range

AUTO range  
↓  
10.00 Hz range  
↓  
100.0 Hz range  
↓  
1000 Hz range

MAX/MIN key

MAX  
↓  
MIN  
↓  
AVE  
↓  
Instantaneous value

MAX  
↓  
MIN  
↓  
AVE  
↓  
Instantaneous value

OUTPUT key

OFF  
↓  
REC



Disabled



























0ADJ/RESET  
key

Disabled

Disabled

## 1.5 Modes

For voltage and current, three modes are provided: DC (direct current, ) , AC (alternating current, ) , and AC+DC (alternating current and direct current, ) modes. Select a proper mode according to the waveform shown below:

Mode	Input waveform	Display	OUTPUT (only for current mode)	
			REC	MON
DC (  )		○ Average value displayed (with polarity)	Disabled	
		× Not measurable		
		× Not measurable		
AC (  )		× Not measurable (zero displayed)		
		○ RMS value		
		× Not measurable		
AC+DC (  )		○ RMS value (without polarity)		
		○ RMS value		
		○ RMS value		



---

# Chapter 2

## Measurement Procedure

---

### 2.1 Preparations

1. Remove the rear cover and insert a battery. (Refer to "Chapter 4 Battery Replacement".)
2. Press **POWER** to turn the unit on. Verify that all segments of the display light up briefly. Then the model name is shown, and the bar graph indicates the battery condition.



Fresh battery



Battery capacity 50%

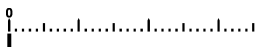

Battery capacity 0 **B**  
Beep tone sounds 3 times

3. The DC current measurement mode is activated.

#### 【Low battery voltage detection function】

After the **B** mark lights and battery voltage drops below a certain level, the power goes off automatically. When this occurs, **bAtt** and **Lo** are displayed.

When power goes off after display of these marks, replace the exhausted battery with a new one.

---

## 2.2 Current Measurement

**NOTE**

- Accurate measurement may be impossible in locations subject to strong external magnetic fields, such as transformers and high-current conductors, or in locations subject to strong external electric fields, such as radio transmission equipment.
- Make sure that only one conductor is clamped in the center of the clamp sensor. If you clamp single-phase (2-wire) or three-phase (3-wire) lines together, it will be impossible to measure.
- The display may show a measured value bigger than the actual value due to a magnetic field interference. The interference is less than 2 A during the measurement.

---

### 2.2.1 Measuring DC Current (DC A)

1. Press  to display  $\approx$ .
2. Switch between the auto range and the manual range as necessary.
3. Press **0ADJ/RESET** to make an auto-zero-adjustment (without clamping the measured conductor inside the clamp sensor) with the clamp sensor firmly closed. (see 2.5.1: Auto-zero-adjustment function). **ADJ** annunciator lights to indicate that auto-zero-adjustment is complete. (If you make an auto-zero-adjustment in the auto range, two current ranges will be adjusted in this mode.)
4. Open the top ends of the clamp core, orient the current direction indicator on the clamp in the current direction of the measured conductor, and clamp the conductor so that it passes through the center of the clamp core.

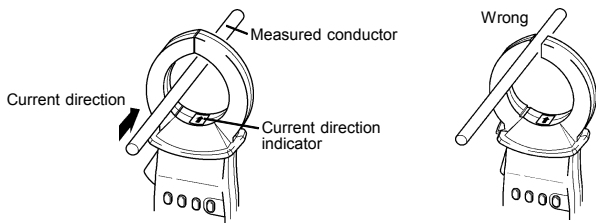

**NOTE**

- The DC A mode permits only DC current measurements that does not include the AC component (see 1.5: Modes).
- The 200 A range will display up to 250 A, however, only the range from 10 A to 200 A can be displayed with guaranteed accuracy.
- At any range, gross errors may occur at 1% or below of the range, whose accuracy is not guaranteed, as a result of internal corrective calculations.

---

## 2.2.2 Measuring AC Current (AC A)

1. Press  to display  $\sim$ .
2. Switch between the auto range and the manual range as necessary.
3. Open the top ends of the clamp core and clamp the measured conductor so that it passes through the center of the clamp core.

**NOTE**



- Just after suspension of input, or when modes are switched under no input, the counter would not become zero for about 10 seconds. This is normal and simply reflects the workings of the internal circuit. But you can measure with guaranteed accuracy before the counter becomes zero.

**NOTE**

- Depending on ambient temperatures, the counter would not become zero under no input. If this happens, perform a zero-cancel correction (2.5.2: Zero-cancel correction function).
- During a f.s. input, the measurement response speed is about 250 ms during rise (0% to 90%) and about 500 ms (100% to 10%) during fall (2.2.5, Figs. 1 and 2).
- The AC A mode does not allow measurement of DC waveforms, full-wave rectification waveforms, half-wave rectification waveforms, or DC+AC waveforms (See 1.5: Modes).
- The 200 A range will display up to 250 A, however, only the range from 10 A to 200 A can be displayed with guaranteed accuracy.
- At any range, gross errors may occur at 1% or below of the range, whose accuracy is not guaranteed, as a result of internal corrective calculations.

---

### 2.2.3 Measuring AC/DC Current (AC+DC A)

1. Press  to display .
2. Switch between the auto range and the manual range as necessary.
3. Press **0ADJ/RESET** to make an auto-zero-adjustment (without clamping the measured conductor inside the clamp sensor) with the clamp sensor firmly closed. (see 2.5.1: Auto-zero-adjustment function). **ADJ** annunciator lights to indicate that auto-zero-adjustment is complete.
4. If the counter fails to become zero under no input, press **HOLD** and then press **0ADJ/RESET** to perform a zero-cancel correction.

- 
5. Open the top ends of the clamp core and clamp the measured conductor so that it passes through the center of the clamp core.

**NOTE**

- Just after suspension of input, or when modes are switched under no input, the counter would not become zero for about 10 seconds. This is normal and simply reflects the workings of the internal circuit. But you can measure with guaranteed accuracy before the counter becomes zero.
- Depending on ambient temperatures, the counter would not become zero under no input. If this happens, perform a zero-cancel correction (2.5.2: Zero-cancel correction function).
- The polarity of the input is not displayed, even if DC current is measured in this mode. If the clamp sensor is reoriented, the measured values may change, but the values are within the guaranteed accuracy. (In case that you would like to measure a DC current which doesn't have AC components, you should make the measurement in DC A mode.)
- During a f.s. input, the measurement response speed is about 250 ms during rise (0% to 90%) and about 500 ms (100% to 10%) during fall (2.2.5, Figs. 1 and 2).
- The 200 A range will display up to 250 A, however, only the range from 10 A to 200 A can be displayed with guaranteed accuracy.
- At any range, gross errors may occur at 1% or below of the range, whose accuracy is not guaranteed as a result of internal corrective calculations.
- When displaying the current measured value during a frequency output, the auto-zero-adjustment is unavailable for the current measurement.

## 2.2.4 Peak Hold Measurement

1. Press  and select a measurement mode for the measured circuit.
2. In DC A and AC+DC A modes, make an auto-zero-adjustment by **0ADJ/RESET**.
3. Set to **PEAK**. The measurement mode is switched by **SLOW/PEAK/Hz** as follows.

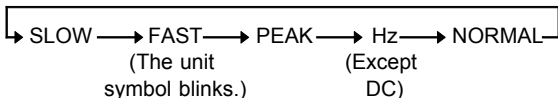

4. Switch between the auto and the manual range as necessary. (If you are unable to estimate the peak current value, start at the 2000A range.)
5. Before the measurement, press **0ADJ/RESET** to reset the residual data.
6. Open the top ends of the clamp core and clamp the measured conductor so that it passes through the center of the clamp core.

### NOTE

- The polarity of the input is not displayed during peak measurements. The measured values may change if the clamp sensor is reoriented, but the values are within the guaranteed accuracy.
- For peak measurements, internal resetting occurs every 250 ms. This may cause a peak detection failure, depending on the timing.
- Even after clamping, press **0ADJ/RESET** to reset the data as necessary.

**NOTE**

- In case that the counter doesn't become zero under no input in peak measurement mode, even though you pressed **0ADJ/RESET** to reset the peak data, the clamp sensor may be magnetized. Quit the peak measurement mode, and perform the auto-zero adjustment by **0ADJ/RESET**. Then make the settings again. (A few counts would remain, even if you push **0ADJ/RESET**.)
- The hold value does not change, unless a larger value is measured, but be careful to avoid accidental loss of data resulting from the auto power-off function. (See 2.9: Auto power-off function.)
- Use the REC function to make measurements longer than the auto power OFF time.
- You cannot output peak values. When pressing **OUTPUT** during peak measurement, the present measured value is outputted.
- To check transitional peak value, press **MAX/MIN** to shift to the Instantaneous value (no annunciator).

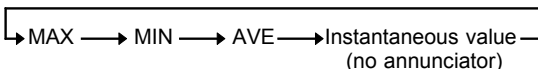

## 2.2.5 Output Function

An output of AC/DC 1 V is produced for 2000-count on the full scale of each current range.

Select either **REC** (record output) or **MON** (waveform output).

(In DC A mode, only **MON** is available. See 1.5: Modes)

1. Press **RANGE** to set the current range.
2. Press **OUTPUT**. **REC** or **MON** annunciator lights and activates the output function, automatically disabling the auto power-off function. (**APS** annunciator is turned off.)

3. **OUTPUT** switches the output modes.

→ REC (Record output) → MON (Waveform output) → Light turned off  
 (Auto power-off inactive) (Auto power-off inactive) (Auto power-off active)

4. Set a range based on the unit's measurement range and other instruments, such as recorders. A conversion table for ranges is provided below.

Range /DIV	10 mV	20 mV	50 mV	0.1 V	0.2 V	0.5 V	1 V
2000 A range	20 A	40 A	100 A	200 A	400 A	1000 A	2000 A
200 A range	2 A	4 A	10 A	20 A	40 A	100 A	200 A

※ The figures are current values per DIV of a measuring instrument, such as a recorder.

**⚠ WARNING**

**To avoid damage to the unit, do not short the output terminal and do not input voltage to the output terminal.**

**NOTE**

- Before using the output function, be sure to press **OUTPUT**, confirming that either **REC** or **MON** annunciator is on. Output is made even when both annunciators are off, but the power will be automatically off in approximately 10 minutes, since the auto power-off function is activated.
- If **OUTPUT** is pressed in an auto range (**AUTO**), the current range is set as the key is pressed. (**AUTO** annunciator is turned off.)
- Errors may occur or output values unless an auto-zero-adjustment is done in DC A mode.
- The zero-cancel function does not affect output. Thus, voltage would be generated because of an ambient temperature, even if there is no input.

**NOTE**

- **REC** outputs are analog outputs. The output response time during a f.s. input differs between rise (0% to 90%, about 250 ms) and fall (100% to 10%, about 500 ms). (Figs 2 and 3) As the measured value is small to the range response time becomes long.
- Changes of counter updating rate, peak measurement, frequency measurement, recording, and data holding are possible when generating current measurement output. (But output will be changed during mode shift, range shift, shift to voltage measurement mode, or auto-zero-adjustment.)
- Use the optional 9094 OUTPUT CORD to connect the unit to a recorder.
- For recorders, use over 1 M $\Omega$  input impedance. Low impedances will affect indicated values.
- Even if you press **A** while recording frequency measurements, output is still for the frequency. To obtain a current output, press **OUTPUT** to disable the frequency output, then make new settings.
- For a long term measurement, use the optional 9445-02 or 9445-03 AC ADAPTER.
- When the AC adapter is used and there is a large amount of noise in the power line, the display may show several counts or noise may be present in the output. In such a case, connect the ground terminal of the level recorder or the L side of the input to ground.

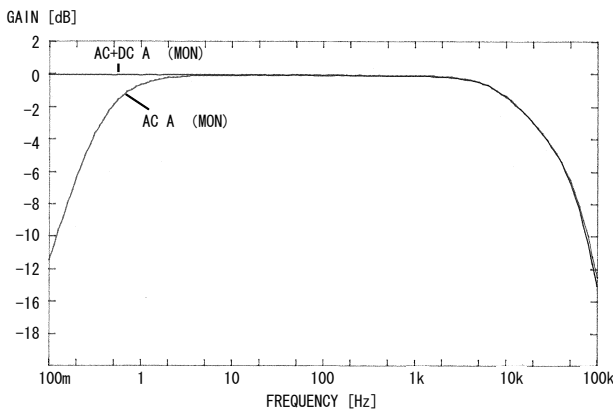

Fig. 1 Frequency Characteristics of Current Output



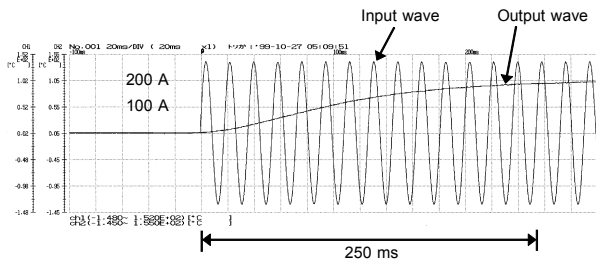

Fig. 2 Waveform of Output Response (Rise)

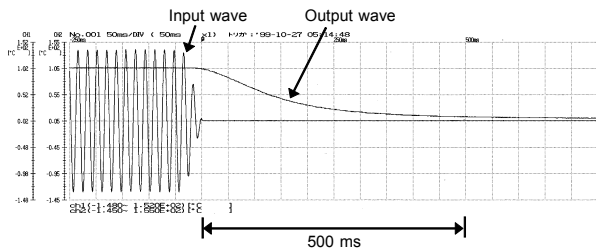



Fig. 3 Waveform of Output Response (Fall)

---

## 2.3 Voltage Measurement

---

### 2.3.1 Measuring DC Voltage (DC V)

1. Press  to display  $\approx$ .
2. Slide the slide cover up using the slide knob. Next, insert the red test lead to V and the black test lead to COM of the voltage measurement terminal.
3. Switch between the auto range and the manual range as necessary.
4. If the counter does not show zero, switch to the range you will use (manual range), and press **OADJ/RESET** to perform an auto-zero adjustment. **ADJ** annunciator lights to indicate that auto-zero-adjustment is complete.
5. Carefully contact the test leads to a circuit.



**NOTE**

- You can perform the auto-zero-adjustment up to 4% of the range.
- When you switch ranges after auto-zero adjustment, deviation of the adjustment value will prevent accurate measurement. Always perform the auto-zero adjustment after switching ranges. (Do not perform auto-zero adjustment when using the auto range.)
- A lit  $\approx$  annunciator indicates that potential is higher at the black test lead than at the red test lead.
- The DC V mode permits only DC voltage measurements that does not include the AC component (see 1.5: Modes).
- Every range will display up to 125% of the range, however, only the range from 10% to 100% can be displayed with guaranteed accuracy.
- At any range, gross errors may occur at 1% or below of the range, whose accuracy is not guaranteed, as a result of internal corrective calculations.

## 2.3.2 Measuring AC Voltage (AC V)

1. Press  to display  $\sim$ .
2. Slide the slide cover up using the slide knob. Next, insert the red test lead to V and the black test lead to COM of the voltage measurement terminal.
3. Switch between the auto range and the manual range as necessary.
4. Carefully contact the test leads to a circuit.

### NOTE

- Just after suspension of input, or when modes are switched under no input, the counter would not become zero for about 10 seconds. This is normal and simply reflects the workings of the internal circuit. But you can measure with guaranteed accuracy before the counter becomes zero.
- Depending on ambient temperatures, the counter would not become zero under no input, if this happens, press  and then press  to perform a zero-cancel correction. (2.5.2: Zero-cancel correction function)
- During a f.s. input, the measurement response speed is about 250 ms during rise (0% to 90%) and about 500 ms (100% to 10%) during fall (2.2.5, Figs. 1 and 2).
- The AC V mode does not allow measurement of DC waveforms, full-wave rectification waveforms, half-wave rectification waveforms, or DC+AC waveforms (See 1.5: Modes).
- Every range will display up to 125% of the range, however, only the range from 10% to 100% can be displayed with guaranteed accuracy.
- At any range, gross errors may occur at 1% or below of the range, whose accuracy is not guaranteed, as a result of internal corrective calculations.

### 2.3.3 Measuring AC/DC Voltage (AC+DC V)

1. Press  to display  $\overline{\infty}$ .
2. Slide the slide cover up using the slide knob. Next, insert the red test lead to V and the black test lead to COM of the voltage measurement terminal.
3. Switch between the auto range and the manual range as necessary.
4. If the counter does not show zero even after display stabilizes, switch to the range you will use (a manual range), press **HOLD** and then press **0ADJ/RESET** to perform a zero-cancel correction. (2.5.2: Zero-cancel correction function)
5. Carefully contact the test leads to a circuit.

#### NOTE

- When you switch ranges after zero-cancel correction, deviation of the correction value will prevent accurate measurement. (Do not perform a zero-cancel correction when using the auto range.) If you accidentally perform zero-cancel correction while using the auto range, repeat zero-cancel correction after turning the power off once and then on again.
- Just after suspension of input, or when modes are switched under no input, the counter would not become zero for about 10 seconds. This is normal and simply reflects the workings of the internal circuit. But you can measure with guaranteed accuracy before the counter becomes zero.
- The polarity of the input is not displayed, even if DC voltage is measured in this mode. If the connections of test leads are moved, the measured values may change, but the values are within the guaranteed accuracy. (In case that you would like to measure DC voltage which doesn't have AC components, you should make the measurement in DC V mode.)
- During a f.s. input, the measurement response speed is about 250 ms during rise (0% to 90%) and about 500 ms (100% to 10%) during fall (2.2.5, Figs. 1 and 2).

**NOTE**

- Every range will display up to 125% of the range, however, only the range from 10% to 100% can be displayed with guaranteed accuracy.
- At any range, gross errors may occur at 1% or below of the range, whose accuracy is not guaranteed, as a result of internal corrective calculations.

### 2.3.4 Peak Hold Measurement

1. Press  $\sqrt{V}$  and select a measurement mode for the measured circuit.
2. Slide the slide cover up using the slide knob. Next, insert the red test lead to V and the black test lead to COM of the voltage measurement terminal.
3. Set to **PEAK**. The measurement mode is switched by **SLOW/PEAK/Hz** as follow.

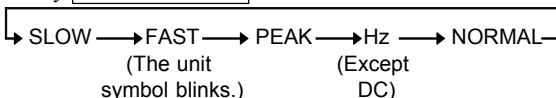

4. Switch between the auto and the manual range as necessary. (If you are unable to estimate the peak voltage value, start at the 600 V range.)
5. Before the measurement, press **0ADJ/RESET** to reset the residual data.

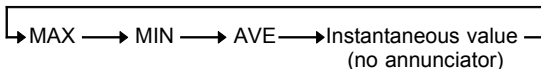

**NOTE**

- The polarity of the input is not displayed during peak measurements. If the connections of test leads are moved, the measured values may change, but the values are within the guaranteed accuracy.
- For peak measurements, internal resetting occurs every 250 ms. This may cause a peak detection failure, depending on the timing.
- To check transitional peak value, press **MAX/MIN** to shift to the Instantaneous value (no annunciator).
- In peak measurement mode, zero-adjustment is disabled.



## 2.4 Frequency Measurement

### 2.4.1 Frequency Measurement in Current Mode

1. Press  and select AC or AC+DC, depending on the circuit to be measured.
2. If the current range of the measured circuit is known, set the current range to the manual range.
3.  switches the annunciators as follows. Select Hz by pressing the key. (The unit symbol **A** blinks, and a current value is displayed on the bar graph.)

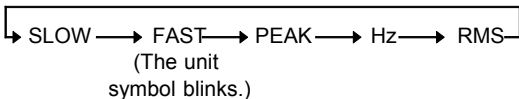

4. Switch the auto range and the manual range as necessary.
5. Open the top ends of the clamp core and clamp the measured conductor so that it passes through the center of the clamp core.

#### NOTE

- At the 100 Hz and 1000 Hz ranges, ---- appears on the counter when the frequency is lower than 10 Hz.
- ---- appears on the counter, if the frequency is lower than 1 Hz.
- **O. L.** appears on the counter, if the frequency is higher than 1 kHz.
- If an input value is significantly lower than the range, an accurate measurement may not be achieved, resulting in ----, **O. L.** or display fluctuations.

**NOTE**

- The 10 Hz range or 100 Hz range will display up to 125% of each range, however, only the range from 10% to 100% can be displayed with guaranteed accuracy.
- **MAX/MIN** does not affect output values.
- The frequencies, whose waveforms are special such as inverters, would not be measurable, when the carrier frequencies are lower than several kHz.
- Full-wave rectification indicates twice the actual value, due to an AC coupling in the internal circuit.
- It would take time to stabilize the counter, depending on the frequency range or the input frequency.

---

## 2.4.2 Frequency Measurement in Voltage Mode

1. Press  **$\overline{V}$**  and select AC or AC+DC, depending on the circuit to be measured.
2. If the voltage range of the measured circuit is known, set the voltage range to the manual range.
2. Slide the slide cover up using the slide knob. Next, insert the red test lead to V and the black test lead to COM of the voltage measurement terminal.
4. **SLOW/PEAK/Hz** switches the annunciators as follows. Select Hz by pressing the key. (The unit symbol **V** blinks, and a voltage value is displayed on the bar graph.)

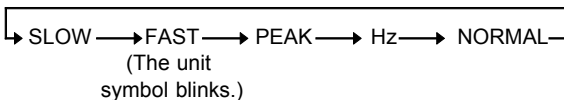

4. Switch between the auto range and the manual range as necessary.
5. Carefully contact the test leads to a circuit.

**NOTE**

- At the 100 Hz and 1000 Hz ranges, ---- appears on the counter when the frequency is lower than 10 Hz.
- ---- appears on the counter, if the frequency is lower than 1 Hz.
- **O. L.** appears on the counter, if the frequency is higher than 1 kHz.
- If an input value is significantly lower than the range, on accurate measurement may not be achieved, resulting in ----, **O. L.** or display fluctuations.
- The 10 Hz range or 100 Hz range will display up to 125% of each range, however, only the range from 10% to 100% can be displayed with guaranteed accuracy.
- The frequencies, whose waveforms are special such as inverters, would not be measurable, when the carrier frequencies are lower than several kHz.
- Full-wave rectification indicates twice the actual value, due to an AC coupling in the internal circuit.
- It would take time to stabilize the counter, depending on the frequency range or the input frequency.

---

### 2.4.3 Output Function For Frequency

Frequency measurement output is available only in current modes.

An output of DC 1 V is produced for 1000-count on the full scale of the frequency range. An output is produced twice per second, the same as display refreshing. (The output waveform will be in step form for a large frequency change, due to D/A outputs.)

1. To make settings, refer to the frequency measurement procedure in a current mode.



2. Press **OUTPUT** . **REC** annunciator lights and activates the output function.
3. The auto power-off function is automatically disabled. (**APS** annunciator is tuned off.)
4. Set a range based on the unit's measurement range and other instruments, such as recorders.

Range/DIV	10 mV	20 mV	50 mV	0.1 V	0.2 V	0.5 V	1 V
1000 Hz range	10 Hz	20 Hz	50 Hz	100 Hz	200 Hz	500 Hz	1000 Hz
100 Hz range	1 Hz	2 Hz	5 Hz	10 Hz	20 Hz	50 Hz	100 Hz
10 Hz range	0.1 Hz	0.2 Hz	0.5 Hz	1 Hz	2 Hz	5 Hz	10 Hz

※ The figures are frequency values per DIV of a measuring instrument, such as a recorder.

**NOTE**

- Before using the output function, be sure to press **OUTPUT** , confirming that **REC** annunciator is on. When **REC** annunciator is off, the output is for current measured values.
- No auto-zero-adjustment is available in AC +DC A mode.
- If **OUTPUT** is pressed in the auto range (**AUTO**), the frequency range is set as the key is pressed. (**AUTO** annunciator is turned off.)
- If you press **HOLD** , the frequency output is also held.
- The display "----" corresponds to 0 V output and the display "O.L." corresponds to 1.36 V output respectively.
- To connect a recorder, use the optional 9094 OUTPUT CORD.
- For recorders, use over 1 M $\Omega$  input impedance.
- Current measurements will continue to be recorded when you shift to the frequency measurement mode during current measurement recording. To obtain frequency measurements, press **OUTPUT** to disable the current measurement mode, then make the new settings.

**NOTE**

- For a long term measurement, use the optional 9445-02 or 9445-03 AC ADAPTER.
- When the AC adapter is used and there is a large amount of noise in the power line, the display may show several counts or noise may be present in the output. In such a case, connect the ground terminal of the level recorder or the L side of the input to ground.

---

## 2.5 Auto-Zero-Adjustment/ Zero-Cancel Correction Function

---

### 2.5.1 Auto-Zero-Adjustment Function

The auto-zero-adjustment function is used to adjust offsets in the internal circuit automatically that result from temperature characteristics or clamp sensor magnetization. The clamp core is magnetized during a large DC current measurement, or when a powerful magnet is placed close to the clamp core.

1. Wait until the counter is stable under no input. Then, press **0ADJ/RESET** . **ADJ** annunciator lights.

**NOTE**

- You can perform the auto-zero-adjustment, if the counter displays within  $\pm 45$  A in a current mode.
- When there is an input or the counter decreases, the measurement accuracy will be spoiled by pressing 0ADJ/RESET as well as the accurate auto-zero-adjustment. If inaccurate auto-zero-adjustment is performed, perform the correct procedure again.
- It would take approximately 20 seconds to stabilize the counter in AC+DC A mode.
- Use the zero-cancel correction function if the counter fails to revert to zero after correct auto-zero-adjustment in AC+DC A mode.

**NOTE**

- If you press **0ADJ/RESET** again during the auto-zero-adjustment in the internal circuit, the auto-zero-adjustment is canceled.
- Do not perform auto-zero adjustment when using auto range in the DC V mode. Always switch to the range you will use (a manual range) before performing the adjustment.

## 2.5.2 Zero-Cancel Correction Function

Use the zero-cancel correction function when the counter fails to become zero under no input in AC A, AC+DC A, AC V, or AC+DC V mode.

1. Press **HOLD** to display **HOLD** annunciator.
2. Press **0ADJ/RESET** . **ADJ** annunciator blinks.

**NOTE**

- Do not perform a zero-cancel correction when using the auto range. Always switch to the range you will use (a manual range) before performing the adjustment.
- When there is an input or the counter decreases, the measured values will be evaluated lower by pressing **0AJD/RESET** .
- If the counter is zero, the zero-cancel correction function does not work.
- In AC+DC A mode, the zero-cancel correction function does not work, unless auto-zero-adjustment is complete.
- The zero-cancel correction function works only on the counter. It will not calibrate output values.

## 2.6 Data Hold Function **HOLD**

This function freezes the counter at any desired point for easy reading.

1. Press **HOLD** . **HOLD** annunciator lights on the

display and the digital display value and bar graph display are maintained.

The data hold function is available for all measurements.

To cancel the data hold function, press **HOLD** again. If you press **RANGE** during the data hold function, the bar graph display the present range.

## 2.7 Alteration of Counter Updates

The counter is updated twice per second when powering on. The counter update may be altered according to measurement conditions.

**SLOW/PEAK/Hz** changes an annunciator as follows:

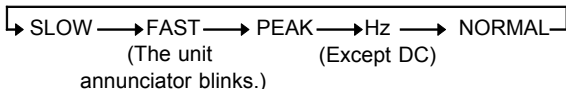

### 2.7.1 SLOW mode

If the counter fluctuates rapidly and is hard to read, you can select a slower update rate (once every 3 seconds) by pressing **SLOW/PEAK/Hz**.

### 2.7.2 FAST mode

- For current measurements and voltage measurements, the counter is updated four times per second in FAST mode. You can measure abrupt changes such as starting currents.
- The unit symbol **A** or **V** blinks.
- To facilitate reading when measuring a starting current, use the record (**REC**) function to hold the maximum value (**MAX**).

## 2.8 Recording Function **REC**

Use the recording function to hold the maximum and minimum measured values and maximum/minimum averages.

### 1. Measurement indicated value

Pressing the **MAX/MIN** key during measurements of current or voltage activates the recording function.

**REC** flashes and the product saves the maximum value (MAX), minimum value (MIN), and average value (AVE) in internal memory from the instant

you press the **MAX/MIN** key. Pressing the

**MAX/MIN** key with the recording function activated switches the display as shown below. If MAX, MIN, or AVE is not displayed, an instantaneous value is assumed.

→ MAX→MIN→AVE→Instantaneous value —  
(no annunciator)

Data (MAX, MIN, AVE) remains displayed while the display is switched. If maximum or minimum data is updated in the meantime, however, the data values will change.

With the recording function activated, the auto power-off function remains disabled. (APS off.)

The average value (AVE) displayed is calculated by:

Average Value = [(Maximum value + Minimum Value)/2].

If the recording function is activated and

Instantaneous value (no annunciator) selected after

you activate PEAK mode with the **SLOW/PEAK/Hz** key, you can see the fluctuation of the peak.

### 2. Display of Elapsed Time

When you press the **MAX/MIN** key to activate the recording function, the bar graph segments flash and the elapsed time appears.

When "min" is shown in the right-hand corner of the bar graph, each segment of the bar graph corresponds to one minute. Every time one minute elapses, one segment of the flashing bar graph goes on. When all segments on the bar graph go on, the elapsed time is 30 minutes.

When the elapsed time exceeds 30 minutes, one segment of the flashing bar graph goes off every time one minute elapses.

When the segments left of a flashing segment remain on: the number of "on" segments represents the elapsed time (0 ~ 29).

The illustration below shows when 20 minutes have elapsed:

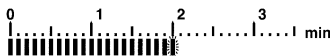

When the segments right of a flashing segment remain on: the number of "off" segments (+30) represents the elapsed time (30 ~ 59).

The illustration below shows when 50 minutes have elapsed:

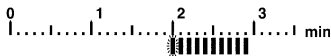

When digital display switches the average value (AVE) to a instantaneous value when you press the **MAX/MIN** key, the right corner of the bar graph indicates hours. In this mode, each segment of the bar graph corresponds to one hour. The way to read the bar graph here is similar to reading it in minutes. When all bar graph segments remain on,

the elapsed time is 29 hours.

The illustration below shows when one hour, 40 minutes have elapsed.



### 3. Deactivation of Recording Function

Pressing the **HOLD** key deactivates the recording function. **HOLD** goes on, **REC** stops flashing and goes on, and the elapsed time stops incrementing. While the recording function is being deactivated, data is not updated, even if the clamp sensor is disconnected from the conductor.

Pressing the **HOLD** key again cancels **HOLD** display and activates the recording function again, with **REC** flashing again.

### 4. Resetting of Recording Function

Push **0ADJ/RESET** key, in the case that data is reset during the recording function action.

### 5. Cancellation of Recording Function

To cancel the recording function, press the related function key (A or V) for the measurement in progress.

Once the recording function is canceled, the auto power-off function becomes effective. (**APS** goes on.)

#### NOTE

- For a long term measurement, use the optional 9445-02 or 9445-03 AC ADAPTER, or check how much the battery power remains by pressing **OUTPUT**.
- When starting the recording function (**REC**) in an auto range, the range is set as the range of when that pushed **MAX/MIN** key.

**NOTE**

- When you need minimum value and average value data, make sure to activate the recording function during measurement. If the function is activated when there is no input, the minimum value will remain zero. Also, when deactivating the recording function, press the **HOLD** key to terminate measurement once the minimum value and average value data have been read. If you disconnect the clamp or test lead from the circuit under measurement without deactivating the recording function beforehand, the minimum value will be zero.
- When the unit is turned off, accumulated data are lost.

---

## 2.9 Auto Power-Off Function **APS**

- When the **APS** annunciator is displayed, the auto power-off function is active.
- If no key is pressed for about 10 minutes, the unit turns itself off automatically.
- Immediately before turning off automatically, **APS** annunciator blinks and a beep tone is heard for about 30 seconds.
- By pressing any key except **POWER**, you will extend the powered state for another 10 minutes.

Procedure for disabling the auto power-off function.

- Press **POWER** with holding down **HOLD**, when you turn power on.
- Use the recording function (**REC**) by pressing **MAX/MIN**.
- Press **OUTPUT** in a current mode.



---

## 2.10 Battery Low Warning

- When this indication appears, the battery is depleted, which can lead to inaccurate measurements. Replace the battery to ensure accuracy.
- To check remaining battery life, check the bar graph, when powering on or by pressing **OUTPUT**. The bar graph provides a rough approximation of remaining battery life. Be careful for the battery life especially before using an output function for a long term or when using the REC function.
- Batteries tend to increase in voltage somewhat when left unused for a long period. Even if the battery warning annunciator becomes temporarily off after the period, replace the battery as soon as possible. If the battery is not replaced at this point in time, the annunciator may not light up immediately on the next occasion. Replace a new battery before it ruins a measurement or causes some other inconvenience. (See Chapter 4: Battery replacement)

---

## 2.11 Beep Tone

To disable the beep tone, hold **RANGE** when turning the unit on by pressing **POWER**.



# Chapter 3

## Specifications

### 3.1 Measurement Specifications

Temperature and humidity for guaranteed accuracy	23°C ± 5°C (73°F ± 9°F), 80% RH or less
Guaranteed accuracy period	1 year, or opening and closing of the Clamp Sensor 10,000 times, whichever comes first

#### 3.1.1 Current Measurement Specifications

○ Current display accuracy

① DC current A (mean value)

Range (Accuracy Range)	Resolution	DC
200A (10.0~200.0A)	0.1A	± (1.3%rdg. +3dgt.)
2000A (100~2000A)	1A	± (1.3%rdg. +3dgt.)

② AC current Arms (true rms)

Range (Accuracy Range)	Resolution	45~66Hz	10~45, 66~1kHz
200A (10.0~200.0A)	0.1A	± (1.3%rdg. +3dgt.)	± (2.0%rdg. +5dgt.)
2000A (100~1800A) (1800~2000A)	1A	± (1.3%rdg. +3dgt.)	± (2.0%rdg. +5dgt.)
		± (2.3%rdg. +3dgt.)	

③ AC+DC current Arms (true rms)

Range (Accuracy Range)	Resolution	DC, 45~66Hz	10~45, 66~1kHz
200A (10.0~200.0A)	0.1A	± (1.3%rdg. +13dgt.)	± (2.0%rdg. +7dgt.)
2000A (100~1800A) (1800~2000A)	1A	± (1.3%rdg. +13dgt.)	± (2.0%rdg. +7dgt.)
		± (2.3%rdg. +13dgt.)	

## ○ Output accuracy

## ① DC current A (mean value)

Range (Accuracy Range)	MON	DC
200A (10.0~200.0A)	1V/f. s.	$\pm (1.3\%rdg. +5mV)$
2000A (100~2000A)	1V/f. s.	$\pm (1.3\%rdg. +5mV)$

## ② AC current Arms (true rms)

## MON

Range (Accuracy Range)	MON	45~66Hz	10~45, 66~1kHz
200A (10.0~200.0A)	AC1V/f. s.	$\pm (1.3\%rdg. +5mV)$	$\pm (2.0\%rdg. +5mV)$
2000A (100~1800A)		$\pm (1.3\%rdg. +5mV)$	$\pm (2.0\%rdg. +5mV)$
(1800~2000A)		$\pm (2.3\%rdg. +5mV)$	

frequency bandwidth:0.5~15kHz ( $\pm 3dB$ )

## REC

Range (Accuracy Range)	REC	45~66Hz	10~45, 66~1kHz
200A (10.0~200.0A)	DC1V/f. s.	$\pm (1.3\%rdg. +10mV)$	$\pm (2.0\%rdg. +10mV)$
2000A (100~1800A)		$\pm (1.3\%rdg. +10mV)$	$\pm (2.0\%rdg. +10mV)$
(1800~2000A)		$\pm (2.3\%rdg. +10mV)$	

Output response (during a f.s. input):

Rise response time (0% to 90%) 250 ms or less

Fall response time (100% to 10%) 500 ms or less

## ③ AC+DC current Arms (true rms)

## MON

Range (Accuracy Range)	MON	DC, 45~66Hz	10~45, 66~1kHz
200A (10.0~200.0A)	1V/f. s.	$\pm (1.3\%rdg. +5mV)$	$\pm (2.0\%rdg. +5mV)$
2000A (100~1800A)		$\pm (1.3\%rdg. +5mV)$	$\pm (2.0\%rdg. +5mV)$
(1800~2000A)		$\pm (2.3\%rdg. +5mV)$	

frequency bandwidth:DC~15kHz ( $\pm 3dB$ )

## REC

Range (Accuracy Range)		REC	DC, 45~66Hz	10~45, 66~1kHz
200A (10.0~200.0A)		DC1V/f. s.	$\pm (1.3\%rdg. + 10mV)$	$\pm (2.0\%rdg. + 10mV)$
2000A	(100~2000A)		$\pm (1.3\%rdg. + 10mV)$	$\pm (2.0\%rdg. + 10mV)$
	(1800~2000A)		$\pm (2.3\%rdg. + 10mV)$	

Output response (during a f.s. input):

Rise response time (0% to 90%) 250 ms or less

Fall response time (100% to 10%) 500 ms or less

○ Peak measurement accuracy (Peak hold function)

During continuous input of sine waves

① DC current A peak (wave peak value)

Range (Accuracy Range)		Resolution	DC
200A (10~500A)		1A	$\pm (1.3\%rdg. + 7dgt.)$
2000A	(100~2300A)		$\pm (1.3\%rdg. + 7dgt.)$
	(2300~2840A)		$\pm (6.0\%rdg. + 7dgt.)$

② AC current A peak (wave peak value)

Range (Accuracy Range)		Resolution	45~66Hz	10~45, 66~1kHz
200A (10~500A)		1A	$\pm (1.3\%rdg. + 7dgt.)$	$\pm (2.0\%rdg. + 7dgt.)$
2000A	(100~2300A)		$\pm (1.3\%rdg. + 7dgt.)$	$\pm (2.0\%rdg. + 7dgt.)$
	(2300~2840A)		$\pm (6.0\%rdg. + 7dgt.)$	

③ AC+DC current A peak (wave peak value)

Range (Accuracy Range)		Resolution	DC, 45~66Hz	10~45, 66~1kHz
200A (10~500A)		1A	$\pm (1.3\%rdg. + 7dgt.)$	$\pm (2.0\%rdg. + 7dgt.)$
2000A	(100~2300A)		$\pm (1.3\%rdg. + 7dgt.)$	$\pm (2.0\%rdg. + 7dgt.)$
	(2300~2840A)		$\pm (6.0\%rdg. + 7dgt.)$	

## ○ Frequency measurement Hz

## Display accuracy

Range (Accuracy Range)	Resolution	
10Hz (1.00~10.00Hz)	0.01Hz	$\pm (0.3\% \text{rdg.} + 1 \text{dgt.})$
100Hz (10.0~100.0Hz)	0.1Hz	$\pm (0.3\% \text{rdg.} + 1 \text{dgt.})$
1000Hz (100~1000Hz)	1Hz	$\pm (1.0\% \text{rdg.} + 1 \text{dgt.})$

## Output accuracy

Range (Accuracy Range)	REC	
10Hz (1.00~10.00Hz)	DC1V/f. s.	$\pm (1.3\% \text{rdg.} + 3 \text{mV})$
100Hz (10.0~100.0Hz)	DC1V/f. s.	$\pm (1.3\% \text{rdg.} + 3 \text{mV})$
1000Hz (100~1000Hz)	DC1V/f. s.	$\pm (2.0\% \text{rdg.} + 3 \text{mV})$

Output response: 4 seconds or less at 1000Hz and 100Hz ranges, 6 seconds or less at 10Hz range

---

**Current Specifications**

---

Maximum permissible current	2000 Arms continuous, 2840 Amax. See Fig.4
Effect of conductor position	within $\pm 0.7\%$ (in any direction from sensor center)
External magnetic field interference	AC 400 A/m (external magnetic fields) corresponds to 2 A or less (display)
Maximum rated voltage to earth	max. 600 Vrms

---

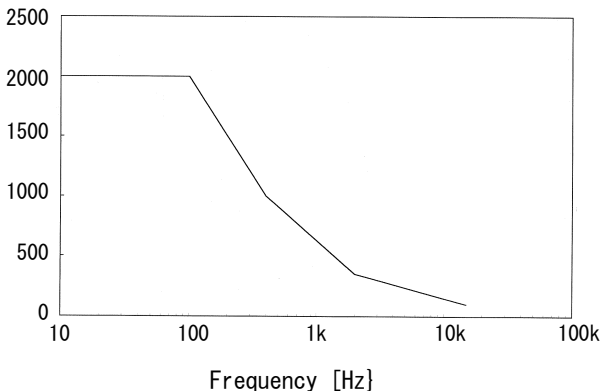

Fig. 4 Frequency-dependent deletion characteristics

### 3.1.2 Voltage Measurement Specifications

#### ○ Voltage display accuracy

##### ① DC voltage V (mean value)

Range (Accuracy Range)	Resolution	DC
30V (3.00~30.00V)	0.01V	$\pm(1.0\%rdg.+3dgt.)$
300V (30.0~300.0V)	0.1V	$\pm(1.0\%rdg.+3dgt.)$
600V (60.0~600V)	1V	$\pm(1.0\%rdg.+3dgt.)$

##### ② AC voltage V<sub>rms</sub> (true rms)

Range (Accuracy Range)	Resolution	45~66Hz	10~45, 66~1kHz
30V (3.00~30.00V)	0.01V	$\pm(1.0\%rdg.+3dgt.)$	$\pm(1.5\%rdg.+5dgt.)$
300V (30.0~300.0V)	0.1V	$\pm(1.0\%rdg.+3dgt.)$	$\pm(1.5\%rdg.+5dgt.)$
600V (60.0~600V)	1V	$\pm(1.0\%rdg.+3dgt.)$	$\pm(1.5\%rdg.+5dgt.)$

##### ③ AC+DC voltage V<sub>rms</sub> (true rms)

Range (Accuracy Range)	Resolution	DC, 45~66Hz	10~45, 66~1kHz
30V (3.00~30.00V)	0.01V	$\pm(1.0\%rdg.+13dgt.)$	$\pm(1.5\%rdg.+13dgt.)$
300V (30.0~300.0V)	0.1V	$\pm(1.0\%rdg.+7dgt.)$	$\pm(1.5\%rdg.+7dgt.)$
600V (60.0~600V)	1V	$\pm(1.0\%rdg.+7dgt.)$	$\pm(1.5\%rdg.+7dgt.)$

#### ○ Peak measurement accuracy (Peak hold function)

During continuous input of sine waves

##### ① DC voltage V peak (wave peak value)

Range (Accuracy Range)	Resolution	DC
30V (3.0~75.0V)	0.1V	$\pm(1.0\%rdg.+7dgt.)$
300V (30~750V)	1V	$\pm(1.0\%rdg.+7dgt.)$
600V (60~1000V)	1V	$\pm(1.0\%rdg.+7dgt.)$

##### ② AC voltage V peak (wave peak value)

Range (Accuracy Range)	Resolution	45~66Hz	10~45, 66~1kHz
30V (3.0~75.0V)	0.1V	$\pm(1.0\%rdg.+7dgt.)$	$\pm(1.5\%rdg.+7dgt.)$
300V (30~750V)	1V	$\pm(1.0\%rdg.+7dgt.)$	$\pm(1.5\%rdg.+7dgt.)$
600V (60~1000V)	1V	$\pm(1.0\%rdg.+7dgt.)$	$\pm(1.5\%rdg.+7dgt.)$



## ③ AC+DC voltage V peak (wave peak value)

Range (Accuracy Range)	Resolution	DC, 45~66Hz	10~45, 66~1kHz
30V (3.0~75.0V)	0.1V	$\pm (1.0\%rdg. +7dgt.)$	$\pm (1.5\%rdg. +7dgt.)$
300V (30~750V)	1V	$\pm (1.0\%rdg. +7dgt.)$	$\pm (1.5\%rdg. +7dgt.)$
600V (60~1000V)	1V	$\pm (1.0\%rdg. +7dgt.)$	$\pm (1.5\%rdg. +7dgt.)$

## ○ Frequency measurement Hz

## Display accuracy

Range (Accuracy Range)	Resolution	
10Hz (1.00~10.00Hz)	0.01Hz	$\pm (0.3\%rdg. +1dgt.)$
100Hz (10.0~100.0Hz)	0.1Hz	$\pm (0.3\%rdg. +1dgt.)$
1000Hz (100~1000Hz)	1Hz	$\pm (1.0\%rdg. +1dgt.)$

## 3.2 General Specifications

## ○ Accessory Functions:

Auto-zero adjustment function Pressing **OADJ/RESET** once in DC A or AC+DC A mode.

Zero cancel function Pressing **OADJ/RESET** once with holding **HOLD** in AC or AC+DC mode.

Recording Maximum (MAX), minimum (MIN), average (AVE) value display selectable for current, voltage and frequency measurements

Data hold Data hold function

Auto power-off Automatic shutdown after  $10.5 \pm 1$  minutes. Beep tone warning before the shutdown. Extending and disabling possible.

Beep tone ON/OFF

○ Display LCD panel

Digital counter 2500 counts max. (current)

3750 counts max. (voltage)

1250 counts max. (frequency)

Bar graph display	35 segments
Over-range display	"O.L." ► (bar graph)
Battery low warning	
Data hold annunciator	<b>HOLD</b>
Auto power-off annunciator	<b>APS</b>
Units	A, V, Hz
Zero suppression	5 counts
Display update rate	Digital counter NORMAL approx. 2 times/second SLOW approx. 1 time/3 seconds FAST approx. 4 times/second
Bar graph	approx. 4 times/second
Display response time (the range is fixed, 0% to 100%)	Current, Voltage: 1 s max. Frequency: 1 s max. (1000 Hz, 100 Hz range) 2.5 s max. (10 Hz range)
Range switching	Auto range, manual (fixed) range (selectable).
Output impedance	300 $\Omega$ max.
Circuit dynamic characteristics (crest factor)	2.5 max. (1.42 for 2000 A range, 1.7 for 600 V range)
Withstand voltage	Clamp sensor - Chassis, clamp sensor - circuit: 5312 Vrms AC for 15 seconds
Effect of conducted radio-frequency electromagnetic field (in 3 V)	Current measurement: -3 A or less
Location for use	Indoor, altitude up to 2000 m

Applicable standards	Safety: EN61010-1:2001 Voltage input: Pollution level 2, measurement category III (expected transient overvoltage: 6000 V) EN61010-031:2002 EN61010-2-032:2002 Type A current sensor EN60529:1991 IP40 (protected against access to hazardous parts with a wire) EMC: EN61326:1997+A1:1998+A2:2001 +A3:2003 EN61000-3-2:2000 EN61000-3-3:1995+A1:2001
Maximum conductor diameter for measurement	$\phi$ 55 mm max.
Operating temperature and humidity range	0 to 40°C (32 to 104°F), 80%RH or less (no condensation)
Temperature characteristics	In 0 to 40°C range: 0.1 × accuracy specifications/°C
Storage temperature range	-10 to 50°C (14 to 122°F, no condensation)
Power source	One 6F22 (006P) 9 V battery or 9445-02 AC ADAPTER (SA10-0910N, SINO-AMERICAN) or 9445-03 AC ADAPTER (EU) (SA10-0910G, SINO-AMERICAN)
Maximum power consumption	110 mVA
Battery life	Approx. 25 hours (continuous, no load)
External dimensions	Approx. 62W × 260H × 39D mm Approx. 2.44"W × 10.24"H × 1.54"D
Mass	Approx. 540 g Approx. 19.0 oz.
Accessories	9207-10 TEST LEAD (red and black) 1 9345 CARRYING CASE 1 Hand Strap 1 6F22(006P) 1 Instruction manual 1

Options	9445-02 AC ADAPTER (SA10-0910N, SINO-AMERICAN)
	9445-03 AC ADAPTER (EU) (SA10-0910G, SINO-AMERICAN)
	9094 OUTPUT CORD

---

---

## Chapter 4 Battery Replacement

---

 **CAUTION**

Do not fix the back casing screws too tightly.  
The torque about  $0.5\text{N}\cdot\text{m}$  is recommended.

1. Remove the two fastening screws of the rear cover, using a Phillips screwdriver.
2. Remove the rear cover.
3. Remove the old battery without pulling the codes of the snap.
4. Securely connect the battery to the battery snap.
5. Replace the rear cover and tighten the fastening screws.

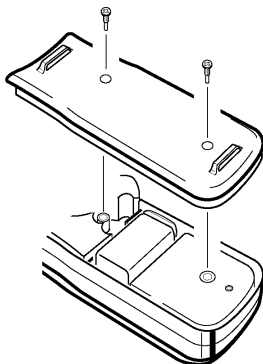



---

## Chapter 5 AC Adapter (Optional)

---

Fully insert the optional 9445-02 AC ADAPTER into the AC adapter connection terminal.

**NOTE**

- The adapter may be used either with or without a battery.
- Use of a battery enables continuous measurement if the AC power source temporarily becomes unavailable, due to a blackout or some other reason.
- When the power supply changes the battery to the AC adapter such as back from a blackout, the following would be shown,
  1. **MON** output waveform during current measurement:  
After the output shifts for approximately 10 ms, the accurate output will be obtained.  
It is recommended that **REC** output in AC+DC A mode should be used, when you would like to make a long term measurement on DC A and a blackout is likely to happen.
  2. REC output waveform during frequency measurement:  
After the output shifts for approximately 10 ms, the accurate output will be obtained.
  3. Peak hold measurement:  
An inaccurate big value will be held.

**NOTE**

All the phenomena are likely to happen, in the case the battery voltage is lower than AC adapter voltage (typ. 9 V) . It is recommended that a new battery should be used, when the blackout seems to be short.

- The battery will be preferred as the power source when the battery voltage is higher than the voltage that supplied by the AC adapter (typically the case with a brand-new battery). When battery voltage dips below the AC adapter, the source automatically switches over to the AC adapter.
- The remaining battery charge (indicated by the bar graph), when used with the AC adapter, is based on the AC adapter voltage. It is not a display for battery life in this case.



---

## Chapter 6 Attaching The Hand Strap

---

Explains how to attach the hand strap, for easy handling of the unit in the field.

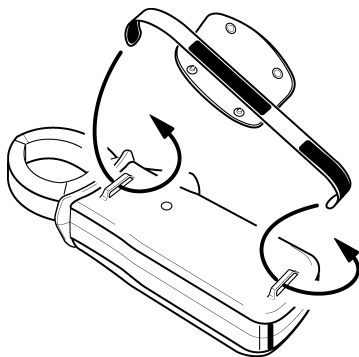



## Chapter 7 Troubleshooting

If the unit seems not to be working normally, check the following points first before requesting service.

Symptom	Battery	Battery clip	Test leads
Unit does not come on.	Yes	Yes	
<b>E</b> indication appears and unit immediately turns off.	Yes		
<b>E</b> indication appears.	Yes		
Unit turns off during use.*	Yes	Yes	
Voltage cannot be measured.			Yes
Remedy: If problem persists, request service.	Replace battery.	Check connection of battery to clip.	Check test leads for broken wire.

**NOTE**

\* When APS (auto power-off) is effective, the unit is automatically shut down when no key is pressed for about 10 minutes. (See 2.9, "Auto Power-Off Function.")

Repair is required if E.001 to E.005 is indicated on the counter, when power is turned on.

○ If no power is supplied:

- If you're using a battery, check that it has sufficient remaining power. (See 2.1: Preparations )
- If you're using the AC adapter, check that it's fully inserted into the AC adapter terminal and socket.
- If no power is supplied by the AC adapter but the battery works, the adapter may be defective. (Make sure that you're using the 9445-02 or 9445-03 AC ADAPTER.)

○ The counter doesn't become zero:

- If this occurs in DC A, AC+DC A or DC V modes, use the auto-zero adjustment function (2.5.1).
- If this occurs in AC A, AC V or AC+DC V mode, use the zero-cancel correction function (2.5.2).
- If this occurs in AC + DC A mode after performing the auto-zero-adjustment, perform the zero cancel correction function (2.5.2).

- The measured value is smaller than the estimated value.

**Current measurement:**

- Check that the clamp sensor is firmly closed.
- Check that the frequency of the measured circuit is within the range provided in the specifications. (A smaller value will be displayed for a high inverter carrier frequency.)
- Check that the proper steps have been taken, according to procedure described in 2.5.1: Auto-zero adjustment function and 2.5.2: Zero-cancel correction function.
- Check that you're using the proper mode. (See 1.5: Modes.)
- Check that the peak value is below the circuit dynamic value provided in the specifications. (To check transitional peak values, see Notes in 2.2.4 and 2.3.4: Peak hold measurement.)
- Check that the crest factor (peak value / RMS value) is below the circuit dynamic value provided in the specifications.
- Check that the battery warning annunciator is off.

**Voltage measurement:**

- Check that the test leads are fully connected.
- Check that the frequency of the measured circuit is within the range provided in the specifications.
- Check that the proper steps have been taken, according to the procedure described in 2.5.1: Auto-zero adjustment function and 2.5.2: Zero-cancel correction function.
- Check that you're using the proper mode. (See 1.5: Modes.)
- Check that the peak value is below the circuit dynamic value provided in the specifications. (To check transitional peak value, see Notes in 2.2.4 and 2.3.4: Peak hold measurement.)
- Check that the crest factor (peak value / RMS value) is below the circuit dynamic value provided in the specifications.
- Check that the battery warning annunciator is off.

**Frequency measurement:**

- Check the waveform. Some special frequencies can't be measured, such as those of inverters.
- Check that the input value corresponds to 10% or more of the range.

- The measured value is larger than the estimated value.

**Current measurement:**

- Check that you're using the proper range.
- Examine the waveform using **MON** output function to confirm that no components but the estimated frequency are being used.
- Check that the counter has been reset with **0ADJ/RESET** before peak measurement.
- Look for magnetic fields, electrical fields or possible noise sources near the unit.
- The measured value would be bigger than the actual value in case that the power supply changes the battery to the AC adapter such as back from a blackout. (See Chapter 5: AC Adapter (Optional) )

**Voltage measurement:**

- Check that you're using the proper range.
- Check that the counter has been reset with **0ADJ/RESET** before peak measurement.
- Look for magnetic fields, electrical fields or possible noise sources near the unit.

**Frequency measurement:**

- Look for magnetic fields, electrical fields or possible noise sources near the unit.
- Check the waveform. Some special frequencies can't be measured, such as those of inverters.

○ The output value is smaller than the estimated value.

- Take the same precautionary steps as for the measured value on the counter.
- Make sure the 9094 OUTPUT CORD is fully connected.
- Make sure you've selected the proper output mode (**REC** or **MON**).
- Make sure the previously selected output mode (current or frequency) is not active.
- Check that the input impedance of the connected measuring instrument is at least 1 MΩ.
- Check that the mode of the connected measuring instrument is not an AC coupling, or that the filter function is disabled.

○ The output value is larger than the estimated value.

- Take the same precautionary steps as for the measured value on the counter.
- Check that you've selected the proper output mode (**REC** or **MON**).
- Check that the previously selected output mode (current or frequency) is not active.
- The output value would shift in case that that the power supply changes the battery to the AC adapter during **MON** output on current measurement on **REC** output on frequency measurement. (See Chapter 5: AC Adapter (Optional) )

○ The measured value fluctuates.

- Check that the measured circuit is stable.
- During voltage measurements, check that the test leads are fully connected.
- Check the waveform. Some special frequencies can't be measured, such as those of inverters.



---

## Chapter 8 Service

---

- The minimum stocking period for replacement parts is five years after end of production.
- For information regarding service, please contact your dealer or the nearest HIOKI representative.
- If the unit is not functioning properly, check the battery. If a problem is found, contact your dealer or HIOKI representative. Pack the unit carefully so that it will not be damaged during transport, and write a detailed description of the problem. HIOKI cannot bear any responsibility for damage that occurs during shipment.



**HIOKI**

**DECLARATION OF CONFORMITY**

Manufacturer's Name: HIOKI E.E. CORPORATION  
Manufacturer's Address: 81 Koizumi, Ueda, Nagano 386-1192, Japan  
Product Name: CLAMP ON AC/DC HiTESTER  
Model Number: 3284, 3285  
Accessory: 9207-10 TEST LEAD  
Options: 9094 OUTPUT CORD  
9445-03 AC ADAPTER (SA10-0910G,  
SINO-AMERICAN)

The above mentioned products conform to the following product specifications:

Safety: EN61010-1:2001  
EN61010-031:2002  
EN61010-2-032:2002

EMC: EN61326:1997+A1:1998+A2:2001+A3:2003  
Class B equipment  
Minimum immunity test requirement  
Portable test, measuring and monitoring equipment  
used in low-voltage distribution systems  
EN61000-3-2:2000  
EN61000-3-3:1995+A1:2001

Supplementary Information:

The products herewith comply with the requirements of the Low Voltage Directive 73/23/EEC and the EMC Directive 89/336/EEC.

HIOKI E.E. CORPORATION

15 September 2006

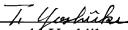
  
Tatsuyoshi Yoshiike  
President

3284A999-05



**HIOKI 3285 CLAMP ON AC/DC HiTESTER**  
Instruction Manual

Publication date: September 2006 Revised edition 10

Edited and published by HIOKI E.E. CORPORATION  
Technical Sales Support Section

All inquiries to Sales and Marketing International  
Department

81 Koizumi, Ueda, Nagano, 386-1192, Japan

TEL: +81-268-28-0562 / FAX: +81-268-28-0568

E-mail: [os-com@hioki.co.jp](mailto:os-com@hioki.co.jp)

URL <http://www.hioki.co.jp/>

Printed in Japan 3285A980-10

- 
- 
- All reasonable care has been taken in the production of this manual, but if you find any points which are unclear or in error, please contact your supplier or the Sales and Marketing International Department at HIOKI headquarters.
  - In the interests of product development, the contents of this manual are subject to revision without prior notice.
  - Unauthorized reproduction or copying of this manual is prohibited.
- 
-

# **HIOKI**

HIOKI E. E. CORPORATION

## **HEAD OFFICE**

81 Koizumi, Ueda, Nagano 386-1192, Japan  
TEL +81-268-28-0562 / FAX +81-268-28-0568  
E-mail: [os-com@hioki.co.jp](mailto:os-com@hioki.co.jp)  
URL <http://www.hioki.co.jp/>

## **HIOKI USA CORPORATION**

6 Corporate Drive, Cranbury, NJ 08512, USA  
TEL +1-609-409-9109 / FAX +1-609-409-9108



---

Printed on recycled paper