



ELST 5012 PG7

Industrial Connectors: Circular Connectors E-series M12/FIXCON: with screw locking: Straight cable socket, self-assembled

Product description

Description	Straight cable plug, unassembled, strain relief by means of clamping cage
Type	ELST 5012 PG7
Order No.	933 163-100
Type of contact	male
Number of contacts	5
Cable gland	PG 7
Conductor size	max. 0.75 mm ²
Standard	IEC 61076-2-101 (Ed. 1)/ IEC 60947-5-2
Housing Color	black

Drawing

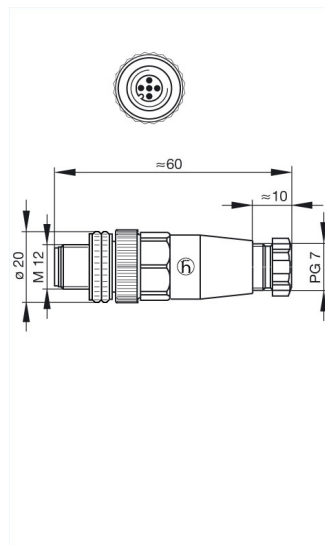

Technical data

Pin dimensions	1 mm
Rated voltage	50 V AC/DC
Rated current	4 A
Type of termination	screw
Suitable cables	diameter 4 mm to 6 mm

Material

Contact material	Cu Zn
Contact surface material	Sn
Contact bearer material	PA
Housing material	PA
Coupling nut material	Zn Al/Ni
O-Ring	NBR

Environmental conditions

Protection class (IEC 60529)	IP 67
Pollution severity	3

Temperature range -25 °C to +90 °C

Inflammability class

Housing 94 V-2

Contact bearer 94 V-2

Approvals

UL UL pending

Packing unit

Packaging unit 100 pieces